

# Kensington®

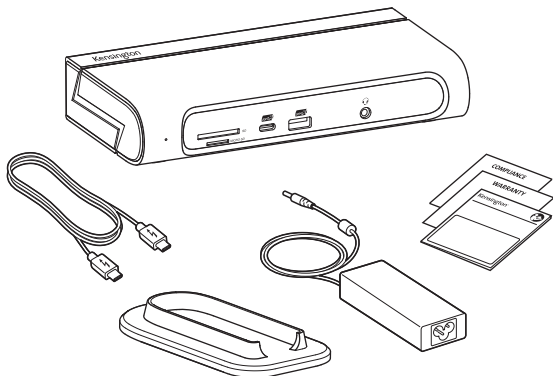

## SD5600T Thunderbolt™ 3 and USB-C Dual 4K Hybrid Dock



**NA/US**

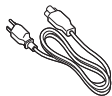

**EU**



**AP/JP**



[kensington.com/register](https://kensington.com/register)

1

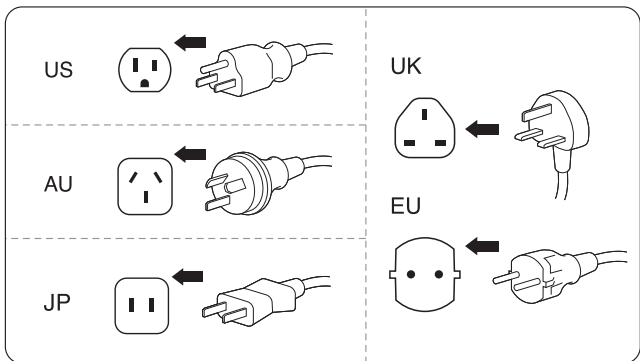
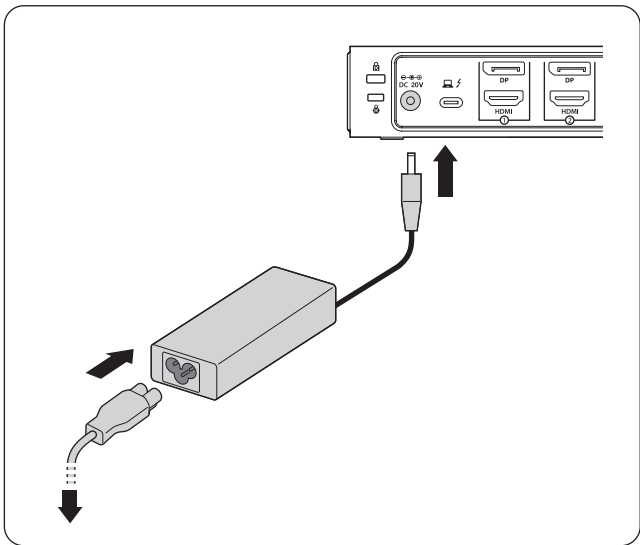

**2**

USB-C  
USB 3.1 Gen2  
10 Gbps (5V/1.5A)

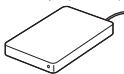

USB-A / USB 3.1 Gen2  
10 Gbps / BC 1.2



**BC 1.2 (5V/1.5A)**\*

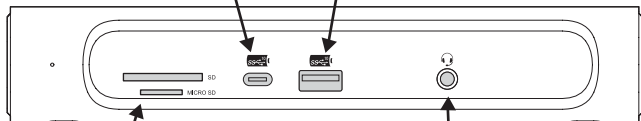

SD/Micro Card  
Support SD4.0, UHS-II



\* USB Battery Charging 1.2-compliant devices

Thunderbolt 3



**Up to 100W**



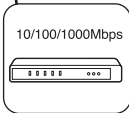
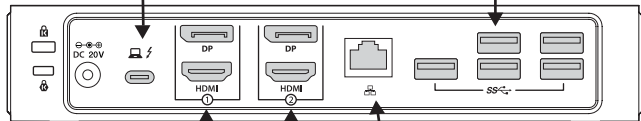
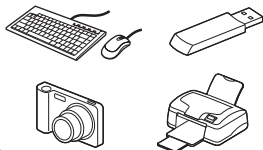

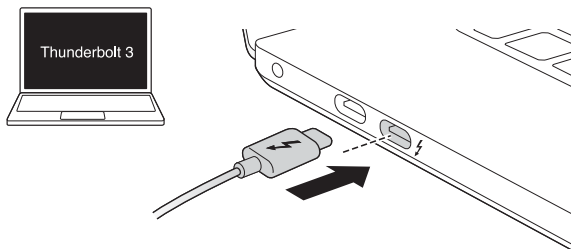
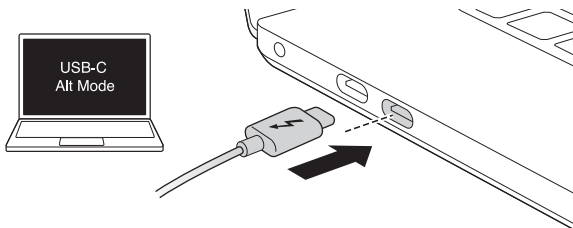
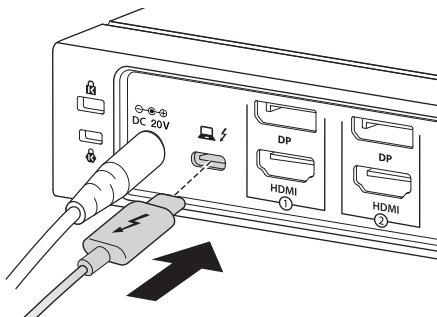
USB-A / USB 3.1 Gen1 / 5 Gbps (5V/0.9A)



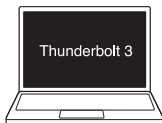





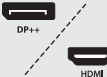
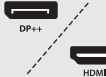

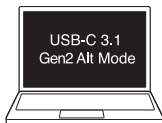

**3****a****b****4**

## 5

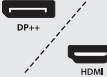

	1X 	2X  
		
HBR2 (DP-1.2)	3840*2160 @60HZ	3840*2160 @60HZ
HBR3 (DP-1.3)	3840*2160 @60HZ	3840*2160 @60HZ



	1X 	2X  		
				
HBR2 (DP-1.2)	3840*2160 @30HZ	1920*1080 @60HZ	1920*1080 @60HZ	1920*1080 @60HZ
HBR3 (DP-1.3)	3840*2160 @60HZ	2560*1440 @60HZ	2560*1440 @60HZ	2560*1440 @60HZ

## 6 Initial Thunderbolt 3 connection for Windows

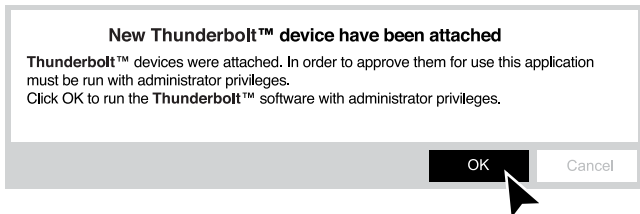

### 6.1 Manage Thunderbolt 3 devices and settings later

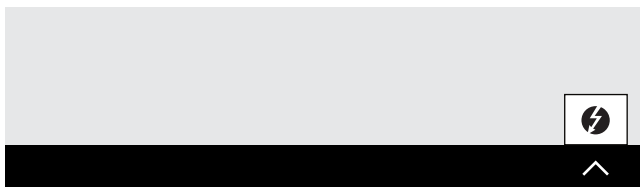

### 6.2

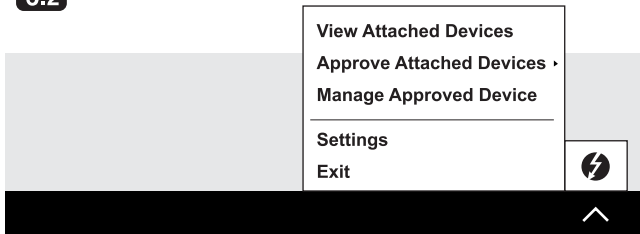

1

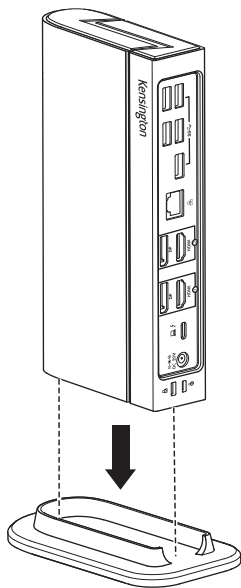

2

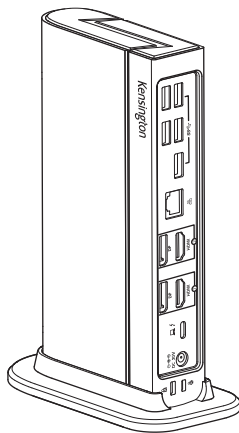

Sold separately

1

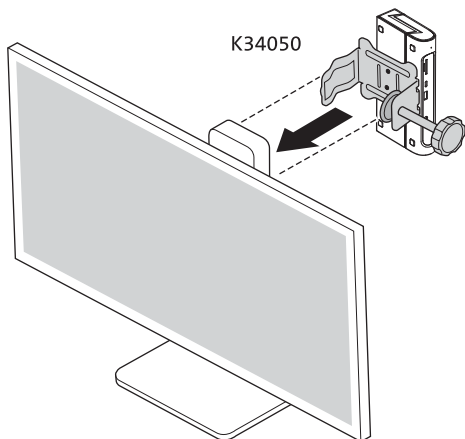

2

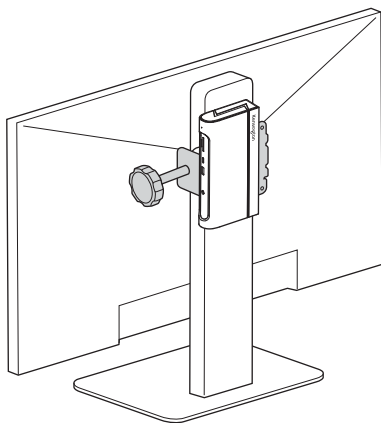



**Sold separately**

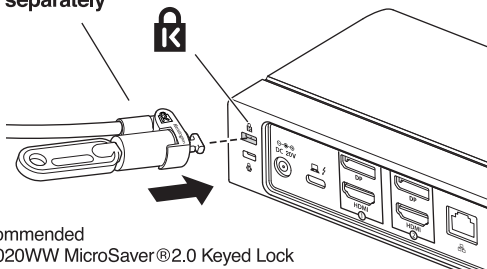

Recommended  
K65020WW MicroSaver®2.0 Keyed Lock

**Sold separately**

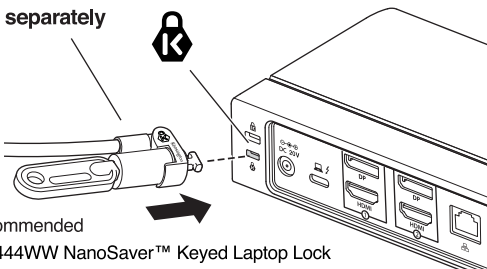

Recommended  
K64444WW NanoSaver™ Keyed Laptop Lock

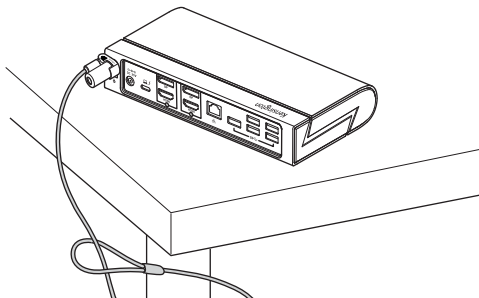

Kensington and the ACCO name and design are registered trademarks of ACCO Brands. All other registered and unregistered trademarks are the property of their respective owners. ©2020 Kensington Computer Products Group, a division of ACCO Brands. Any unauthorized copying, duplicating, or other reproduction of the contents hereof is prohibited without written consent from Kensington Computer Products Group. All rights reserved. 06/20



**Kensington Computer Products Group**  
A Division of ACCO Brands  
1500 Fashion Island Blvd, 3rd Floor  
San Mateo, CA 94404, USA

**Importer:**

LEITZ ACCO Brands GmbH & Co KG  
Siemensstraße 64  
70469 Stuttgart  
Germany

**ACCO Brands Canada Inc**

7381 Bramalea Rd  
Mississauga, ON L5S 1C4  
<https://accobrandscanada.com/>

**ACCO Brands Australia - Kensington**

2 Coronation Avenue  
Kings Park NSW 2148  
Australia

**ACCO Brands Chile S.A.,**

Avda. Presidente Riesco # 5711,  
oficina 201  
Las Condes, Santiago, Chile  
CP 7561114  
[www.accobrandsc.cl](http://www.accobrandsc.cl)

**Importado e Distribuído por:**

Tilbra Produtos De Papelaria Ltda.  
CNPJ: 44.990.901/0001-43  
Rua Aymorés, 6-9 – Bauru/SP – Brasil  
CEP 17013-900  
[sac@tilbra.com.br](mailto:sac@tilbra.com.br)

**Dystrybutor:**

Essekte Polska Sp. z o.o., ul.  
Przemysłowa 11A, 26-900  
Kozienice

**Forgalmazza:**

Essekte Kft, Váci út 76. V. torony  
I. emelet,  
1133 Budapest,  
Magyarország

**Distributor:**

Essekte Sales SRL,  
Gheorghe Țițeica 121C,  
Sector 2, București,  
România

**Distribútor:**

Essekte, s.r.o., V Lužích 818,  
142 00 Praha 4,  
Česká republika

**Импортер:**

ООО «Эссельте», Россия,  
125040, Москва, 3-я улица  
Ямского поля, д.18, тел.  
+7(495)933-27-63

**ДИСТРИБЬЮТОР:**

Essekte Polska Sp. z o.o., ul.  
Przemysłowa 11A, 26-900  
Kozienice  
Импорртаушы: "АБДИ Компани" АҚ,  
Алматы қ., Сейфуллин даңғ. 465/191

**Дистрибьютор:**

Эссельте Польска Сп. з о.о., вулиця  
Пшемислова, 11А, 26-900 Козеніц

广州市爱珂贸易有限公司  
广州市天河区林和西路159号  
中泰国际北塔5楼, 501/701室  
邮编: 510620  
电话: 400 600 4599  
网址: <https://www.kensington.com/zh-CN>  
邮箱: [infocn@kensington.com](mailto:infocn@kensington.com)

アコ・ブランド・ジャパン株式会社  
〒164-8721  
東京都中野区本町1-32-2  
ハーモニータワー14F  
<https://www.kensington.com/ja-JP>  
E-MAIL: [JP.Kensington@acco.com](mailto:JP.Kensington@acco.com)