

# Omada

## Installation Guide

Indoor/Outdoor Access Point



### Setup with videos

Scan QR code or visit  
[www.tp-link.com/support/setup-video/](http://www.tp-link.com/support/setup-video/)



## 1 Overview

### Package Contents

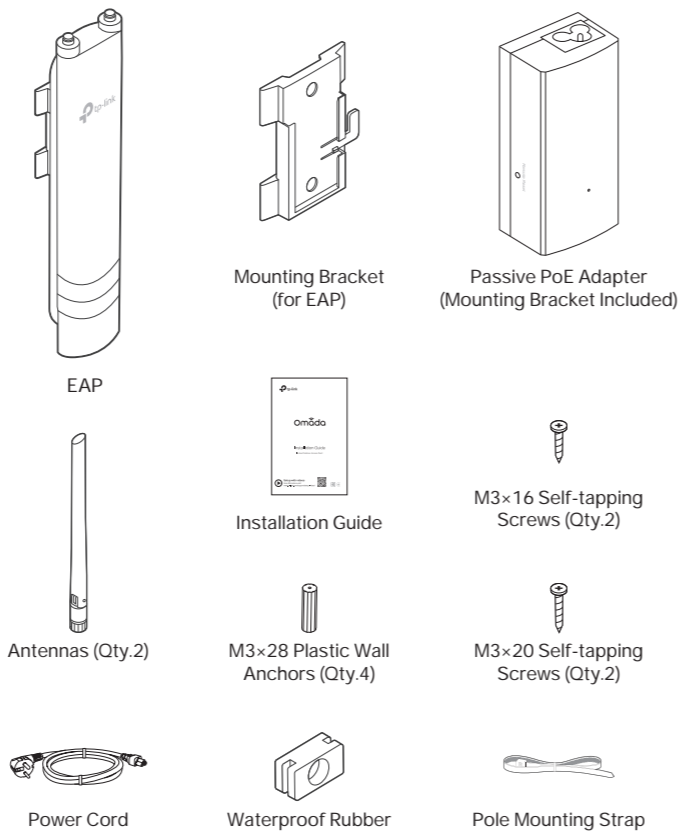

## Panel Layout

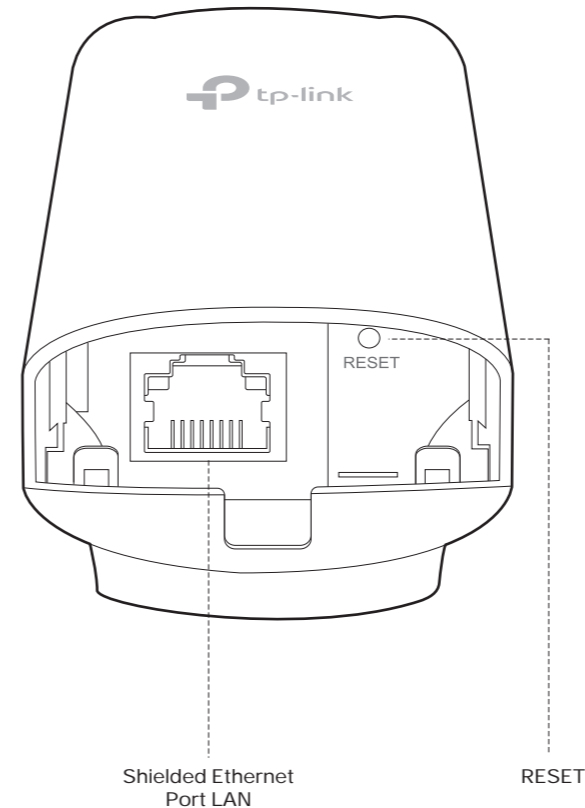

## SYS LED Explanation

LED Status	Indication
Flashes green twice	Initialization is completed.
Solid green	The device is initializing or working properly.
Flashing yellow	System errors. RAM, Flash, Ethernet, WLAN or firmware may be malfunctioning.
Flashing yellow, green	Firmware update is in progress. Do not disconnect or power off the device.
Quickly flashing yellow, green	The device is being reset to its factory default settings.
Flashing green slowly (Only for EAP225-Outdoor)	The device is in an isolated state.

## Passive PoE Adapter

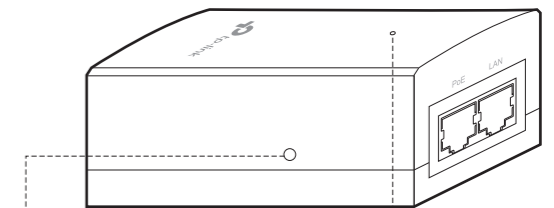

**Remote Reset:**  
Press and hold for about 8 seconds until the LED is quickly flashing yellow then green. The EAP will restore to factory default settings.

**Power LED:**  
On: Power on  
Off: Power off

Note: EAP225-Outdoor does not support the Remote Reset feature.

## 2 Lightning and ESD Protection

Before mounting the EAP, you should consider Lightning and ESD Protection to ensure safety.

Proper grounding is extremely important for outdoor devices. By using a shielded CAT5e (or above) cable for connection, you can reduce the damage of ESD attacks.

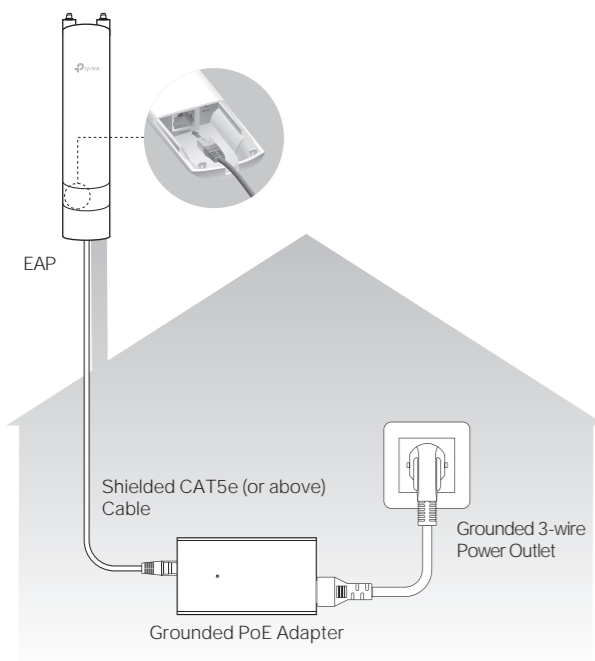

## 3 Hardware Installation

### Mount the EAP

The EAP can be pole-mounted or wall-mounted. Follow the steps below for the appropriate installation.

#### Option 1: Pole Mounting

##### Step 1:

Lead the end of the pole mounting strap through the back of the EAP.

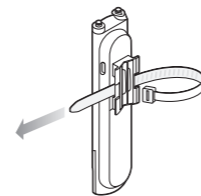

##### Step 2:

Position the EAP and wrap the pole mounting strap around the pole. Feed the end through the screw-block and tighten the strap until the EAP is secure.

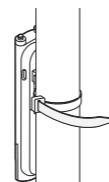

##### Step 3:

Connect the antennas to the EAP. For optimal Wi-Fi performance, adjust the direction of the antennas. It is recommended to position the antennas at 45-degree angles.

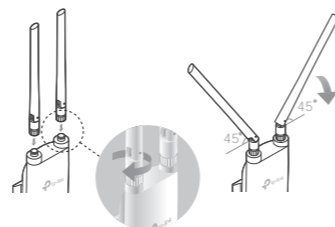

#### Option 2: Wall Mounting

##### Step 1:

Place the mounting bracket (for EAP) in the right position. Mark two positions for the screw holes. Drill two 6mm holes for the screws at the marked positions.

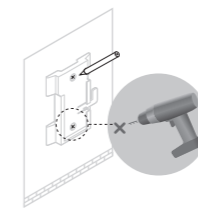

##### Step 2:

Insert the plastic wall anchors into the 6mm holes. Align the bracket (for EAP) to the plastic wall anchors and drive the self-tapping screws into the anchors through the bracket (for EAP).

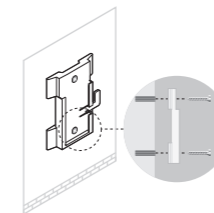

##### Step 3:

Align the mounting tabs on the back of the EAP with the slot of the mounting bracket (for EAP). Push and slide the EAP downward until it locks into place.

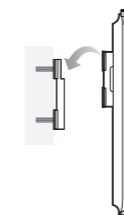

##### Step 4:

Connect the antennas to the EAP. For optimal Wi-Fi performance, adjust the direction of the antennas. It is recommended to position the antennas at 45-degree angles.

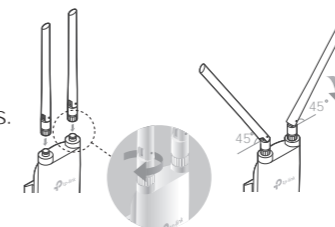

## Connect Cables

### Step 1:

Firmly grasp the rear of the interface cover and pull it downward.

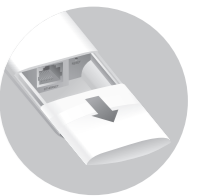

### Step 2:

Use an adequate Ethernet cable to connect the LAN port. The length of cable is up to 100m for steady power supply. Shielded CAT5e (or above) cable is recommended.

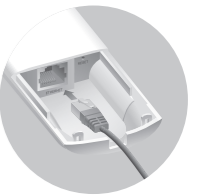

### Step 3:

Attach the waterproof rubber insert to the groove at the underside of the device for waterproofing. Move the Ethernet cable to the hole of the waterproof rubber insert.

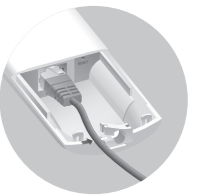

### Step 4:

Flatten the waterproof rubber insert until it gets parallel to the device. Replace the cover until it firmly locks into place.

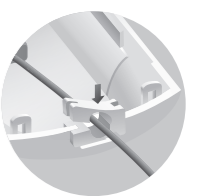

## Power On

The EAP can be powered via the provided passive PoE adapter or a PSE device (such as a PoE switch).

### Via Passive PoE Adapter

#### Connecting the PoE Adapter

Connect the EAP to a Power over Ethernet (PoE) adapter as follows:

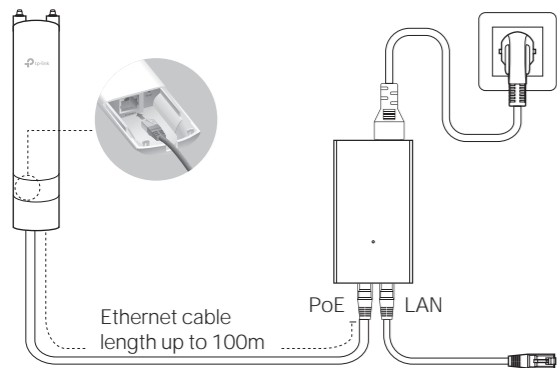

#### Mounting the PoE Adapter (Optional)

Note: To ensure the passive PoE adapter is attached most securely, it is recommended to install the adapter with the Ethernet port facing upward.

#### Step 1:

Remove the mounting bracket from the passive PoE Adapter. Drill two holes on the wall and insert the plastic wall anchors into the holes. Secure the mounting bracket to the wall. Make sure the shoulders at the corners of the mounting bracket are on the outside and pointing upward.

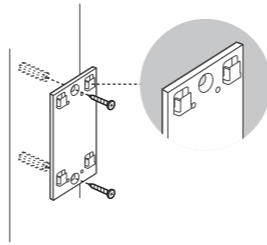

#### Step 2:

Attach the passive PoE adapter to the mounting bracket (for PoE Adapter) by sliding the adapter in the direction of the arrows until it locks into place.

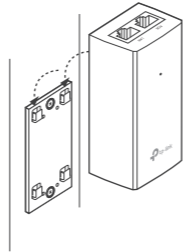

### Via PoE Switch (Only for EAP225-Outdoor)

Connect an Ethernet cable from the PoE switch to the ETHERNET port.

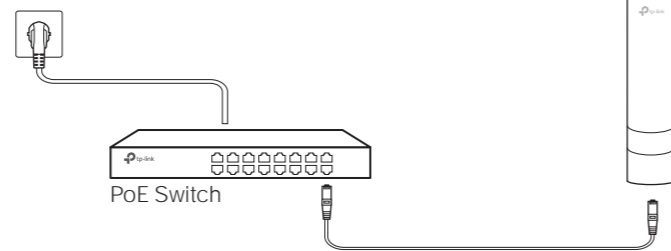

## Option2: Controller Mode

Controller Mode is applicable to configuration for mass EAPs. All EAPs can be centrally configured and monitored via an Omada Software Controller or an Omada Cloud Controller (e.g. OC200).

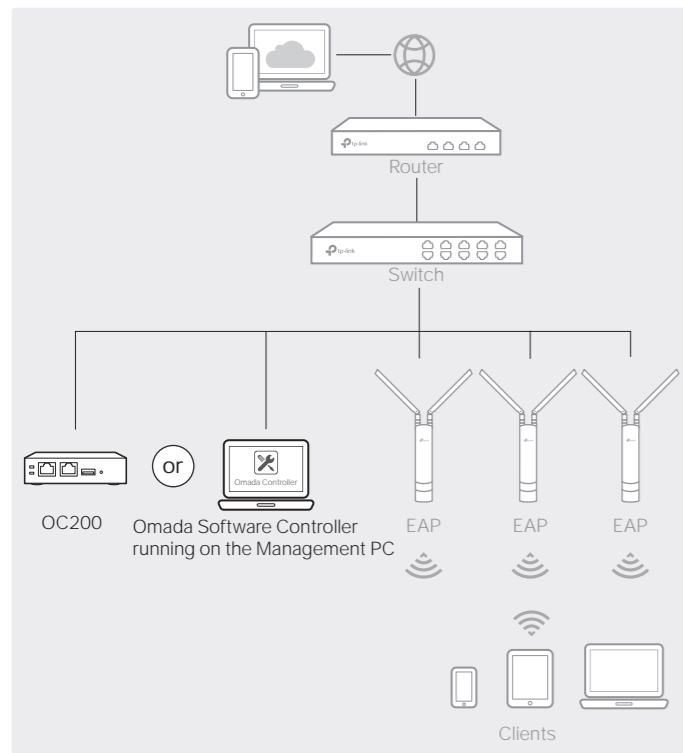

### Via Software Controller

1. On the PC with Windows OS or Linux OS, download the Omada Controller installation file from <https://www.tp-link.com/download/EAP-Controller.html>.
2. Run the file and follow the wizard to install the Omada Controller.
3. Launch the Omada Controller and follow the step-by-step instructions to complete the Quick Setup. After the wizard is finished, a login screen will appear.
4. Enter the username and password you created and click Log in. Then you can further configure the Omada Controller.

#### Omada Cloud Service

After installing Omada Controller, you can remotely configure the controller through cloud service when your management device can access the internet. Follow the steps below.

1. Enable Cloud Access on the setting page on the controller and bind a TP-Link ID to your controller. If you have configured this in the setup wizard, skip the step.
2. Launch a web browser and enter <https://omada.tplinkcloud.com> in the address bar.
3. Enter your TP-Link ID and password to log in. A list of Omada Controller that has been bound with your TP-Link ID will appear. Then you can click Launch to further configure the controller.

## 4 Software Configuration

A DHCP server (typically a router with DHCP function enabled) is required to assign IP addresses to the EAPs and clients in your local network.

The EAP supports two configuring options:

- To configure and manage EAPs singly (usually suitable for a small network with a few EAPs), Standalone Mode is recommended. Please refer to Option 1.
- To configure and manage EAPs in batch, Controller Mode is recommended. Please refer to Option 2.

### Option1: Standalone Mode

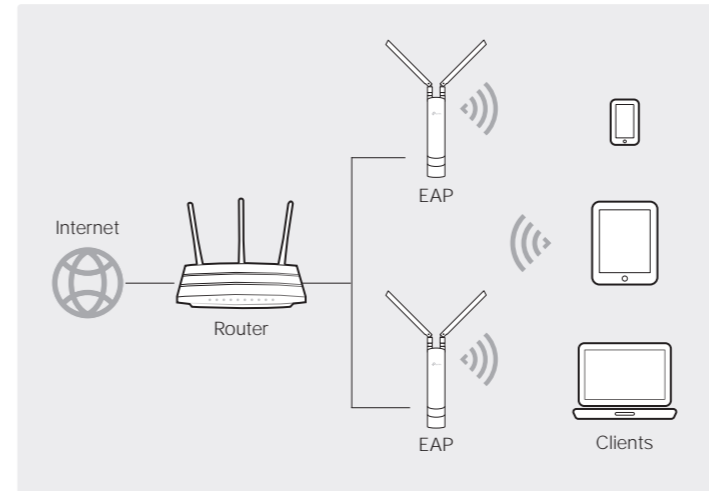

### \* Omada App

With Omada app, you can also manage your Omada Controller at a local site and remote site. Note that Omada software Controller needs to be kept running when using Omada app.

1. Download the TP-Link Omada app on your mobile device. It can be downloaded from Apple Store or Google Play:



2. Launch your app and configure the controller at a local site or remote site.

- Local Management
  - a. Connect your mobile device to the EAP by using the default SSID (format: TP-Link\_2.4GHz/5GHz\_XXXXXX) printed on the label at the bottom of the product.
  - b. Launch the app and go to Local Access, tap the + button on the upper-right corner to add the Omada controller. Then you can further configure the controller.
- Remote Management
  - a. Make sure Cloud Access is enabled on your controller and your controller has been bound with a TP-Link ID.
  - b. Launch the app and log in with your TP-Link ID. Then go to Cloud Access. A list of Omada Controller that has been bound with your TP-Link ID will appear. Then you can further configure the controller.

### Via Omada App

1. Download the TP-Link Omada app on your mobile device. It can be downloaded from Apple Store or Google Play:



2. Connect your mobile device to the EAP by using the default SSID (format: TP-Link\_2.4GHz/5GHz\_XXXXXX) printed on the label at the bottom of the product.
3. Open the Omada app, and wait for the EAP to appear on the Standalone APs page. Tap on the EAP you want to configure.

The Omada app is designed to help you quickly configure the common settings. If you want to configure more settings, you can log in to the web page of your EAP or the controller.

### Via a Web Browser

1. Connect wirelessly by using the default SSID (format: TP-Link\_2.4GHz/5GHz\_XXXXXX) printed on the label at the bottom of the product.
2. Launch a web browser and enter <http://tplinkeap.net> in the address bar. Use admin for both Username and Password to log in.
3. Set up a new Username and Password for secure management purpose. Modify the wireless parameters and reconnect your wireless devices to the new wireless network.

To configure other EAPs, connect your device to the EAP by the corresponding default SSID and repeat the steps listed above. You can configure some basic functions in Standalone Mode. If you want to configure advanced functions, please use Controller Mode.

### Via Cloud Controller

Omada Cloud Controller (e.g. OC200), which is pre-installed with the Omada Software Controller, is a good alternative for the Software Controller if you have no spare PC to keep running in the network. It needs to be purchased additionally. For more details, refer to the Installation Guide of Omada Cloud Controller.

#### Attention:

For EAP225-Outdoor, in EU member states and EFTA countries, the operation in the frequency range 5150MHz-5350MHz is only permitted indoors.

For EAP Controller, go to Access Point page and select the desired EAP to specify the channel. For web browser, go to Wireless > Wireless Settings to specify the channel.

AT	BE	BG	CH	CY	CZ	DE	DK	EE	EL	ES	FI	FR	HR	HU	IE
IS	IT	LI	LT	LU	LV	MT	NL	NO	PL	PT	RO	SE	SI	SK	UK

For detailed configurations, please visit <https://www.tp-link.com/support> to download the User Guide of EAP in the download center.

To ask questions, find answers, and communicate with TP-Link users or engineers, please visit <https://community.tp-link.com> to join TP-Link Community.

For technical support, the user guide and other information, please visit <https://www.tp-link.com/support>, or simply scan the QR code.

If you have any suggestions or needs on the product guides, welcome to email [techwriter@tp-link.com.cn](mailto:techwriter@tp-link.com.cn).



#### Safety Information

- Keep the device away from water, fire, humidity or hot environments.
- Do not attempt to disassemble, repair, or modify the device.
- Do not use the device where wireless devices are not allowed.
- Do not use any other chargers than those recommended.
- Adapter shall be installed near the equipment and shall be easily accessible.

The products of TP-Link partly contain software code developed by third parties, including software code subject to the GNU General Public License ("GPL"). As applicable, the terms of the GPL and any information on obtaining access to the respective GPL Code used in TP-Link products are available to you in GPL-Code-Centre under (<https://www.tp-link.com/en/support/gpl/>). The respective programs are distributed WITHOUT ANY WARRANTY and are subject to the copyrights of one or more authors. For details, see the GPL Code and other terms of the GPL.