



User's Manual

ColorEdge® CS2740

Color Management LCD Monitor

Important

Please read this "User's Manual", and "PRECAUTIONS" (separate volume) carefully to familiarize yourself with safe and effective usage.

-
- Refer to the "Setup Guide" for information on the installation / connection of the monitor.
 - For the latest product information including the "User's Manual", refer to our web site :
www.eizoglobal.com
-

Location of Caution Statement

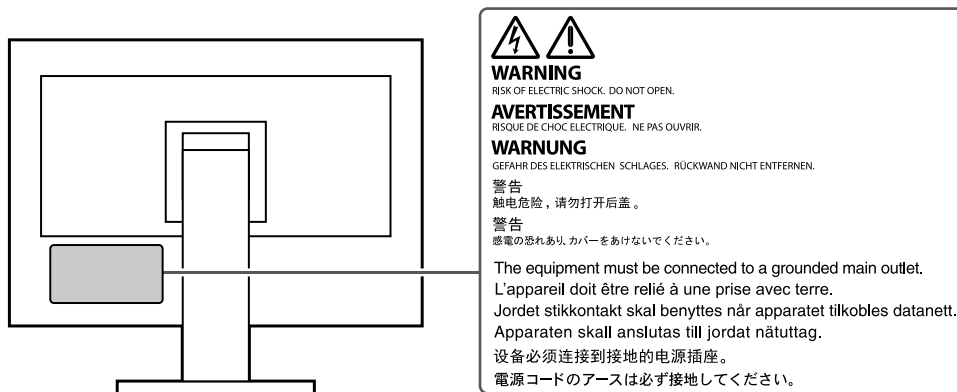

This product has been adjusted specifically for use in the region to which it was originally shipped. If operated outside this region, the product may not perform as stated in the specifications.

No part of this manual may be reproduced, stored in a retrieval system, or transmitted, in any form or by any means, electronic, mechanical, or otherwise, without the prior written permission of EIZO Corporation. EIZO Corporation is under no obligation to hold any submitted material or information confidential unless prior arrangements are made pursuant to EIZO Corporation's receipt of said information. Although every effort has been made to ensure that this manual provides up-to-date information, please note that EIZO monitor specifications are subject to change without notice.

Notice for this monitor

Aside from general purposes like creating documents, viewing multimedia content, this product is also suited to applications such as graphics creation and digital photo processing, where accurate color reproduction is a priority.

This product has been adjusted specifically for use in the region to which it was originally shipped. If the product is used outside the region, it may not operate as specified in the specifications.

This product may not be covered by warranty for uses other than those described in this manual.

The specifications noted in this manual are only applicable when the following are used:

- Power cords provided with the product
 - Signal cables specified by us
-

Only use optional products manufactured or specified by us with this product.

If you place this product on a lacquer-coated desk, the color may adhere to the bottom of the stand due to the composition of the rubber. Check the desk surface before use.

It takes about 30 minutes (under our measurement conditions) for the monitor display to stabilize. Please wait 30 minutes or more after the monitor power has been turned on, and then adjust the monitor.

Monitors should be set to a lower brightness to prevent a loss in the screen quality caused by long-term use and to maintain stable use.

When the screen image is changed after displaying the same image for extended periods of time, an afterimage may appear. Use the screen saver or power save function to avoid displaying the same image for extended periods of time. Depending on the image, an afterimage may appear even if it was displayed for a short period of time. To remove such a phenomenon, change the image or keep the power turned off for several hours.

If the monitor displays continuously over a long period of time, dark smudges or burn-in may appear. To maximize the life of the monitor, we recommend the monitor be turned off periodically.

Periodic cleaning is recommended to keep the monitor looking new and to prolong its operation lifetime (refer to [“Cleaning” \(page 4\)](#)).

The LCD panel is manufactured using high-precision technology. Although, missing pixels or lit pixels may appear on the LCD panel, this is not a malfunction. Percentage of effective dots: 99.9994 % or higher.

The backlight of the LCD panel has a fixed lifetime. Depending on the usage pattern, such as usage for long continuous periods, the lifespan of the backlight may run out sooner, requiring replacement. When the screen becomes dark or begins to flicker, please contact your local EIZO representative.

Do not press on the LCD panel or edge of the frame strongly, as this may result in display malfunctions, such as interference patterns, etc. If pressure is continuously applied to the LCD panel surface, the liquid crystal may deteriorate or the LCD panel may be damaged. (If the pressure marks remain on the panel, leave the monitor with a black or white screen. The symptom may disappear.)

Do not scratch or press on the LCD panel with any sharp objects, at this may result in damage to the LCD panel. Do not attempt to brush with tissues as this may scratch the panel.

When the monitor is cold and brought into a room or the room temperature goes up quickly, dew condensation may occur on the interior and exterior surfaces of the monitor. In that case, do not turn the monitor on. Instead wait until the dew condensation disappears, otherwise it may cause some damage to the monitor.

Cleaning

The stains on the cabinet and LCD panel surface can be removed by moistening part of a soft cloth with water.

Attention

- Chemicals such as alcohol and antiseptic solution may cause gloss variation, tarnishing, and fading of the cabinet or LCD panel, and also quality deterioration of the image.
- Never use thinner, benzine, wax, or abrasive cleaner as they may damage the cabinet or LCD panel surface.

Note

- It is recommended that ScreenCleaner (available as an option) be used to clean the cabinet and LCD panel surface.

To use the monitor comfortably

- An excessively dark or bright screen may affect your eyes. Adjust the brightness of the monitor according to the environmental conditions.
- Staring at the monitor for a long time tires your eyes. Take a 10-minute rest every hour.

Contents

Notice for this monitor	3	Chapter 5 Administrator Settings.....	33
Cleaning	4	5-1. Basic Operation of the "Administrator Settings" Menu.....	33
To use the monitor comfortably	4	5-2. "Administrator Settings" Menu Functions	34
Contents.....	5	Chapter 6 Troubleshooting.....	36
Chapter 1 Introduction.....	6	6-1. No Picture	36
1-1. Features	6	6-2. Imaging Problems.....	37
● User-defined custom key function.....	6	6-3. Other Problems	38
● Support for DisplayPort Alt Mode / USB Power Delivery	6	Chapter 7 Attaching/Detaching the Stand.....	39
● Support for Color Management Software "ColorNavigator 7" and Color Matching Tool for Photo Prints "Quick Color Match"	6	7-1. Removing the Stand	39
1-2. Controls and Functions	7	7-2. Attaching the Optional Arm.....	40
● Front	7	7-3. Attaching the Original Stand.....	40
● Rear.....	8	Chapter 8 Reference	41
1-3. Supported Resolutions	9	8-1. Attaching/Detaching the Cable Holder	41
● DisplayPort.....	9	8-2. Connecting Multiple External Devices.....	43
● HDMI	10	8-3. Making Use of the USB Hub Function	44
● USB Type-C	12	● Connection Procedure	44
1-4. Changing the PC Display Settings.....	14	8-4. Specifications	45
● Windows 10.....	14	● Accessories.....	46
● Windows 8.1 / Windows 7	14	Appendix.....	47
● macOS	15	Trademark	47
Chapter 2 Basic Adjustments/Settings.....	16	License	47
2-1. Switch Operation Method	16	Information for Radio Interference	48
● Operation Guide Icons	17		
2-2. Switching Input Signals	17		
2-3. Switching the Display Mode (color mode) ...	17		
● Display Modes.....	18		
Chapter 3 Custom Key Settings.....	19		
3-1. Basic Operation of the Custom Keys	19		
3-2. Assigning a Function to a Custom Key.....	19		
● Functions that can be Assigned to Custom Keys	21		
Chapter 4 Advanced Adjustments/Settings... 22	22		
4-1. Basic Operation of the Setting Menu	22		
4-2. Setting Menu Functions	24		
● Signal	24		
● Color.....	26		
● Screen	29		
● Preferences.....	30		
● Languages	32		
● Information	32		

Chapter 1 Introduction

This chapter describes the features of the monitor and the name of each control.

1-1. Features

● User-defined custom key function

Work efficiency can be improved by assigning frequently used functions to the switches on the front of the monitor. The functions that can be assigned to custom keys are the following:

- Brightness
- Prev. Color Mode
- Information

See “Chapter 3 Custom Key Settings” (page 19).

● Support for DisplayPort Alt Mode / USB Power Delivery

This product is equipped with a USB Type-C connector and supports video signal transfer (DisplayPort Alt Mode) and USB device charging (USB Power Delivery).

It supplies a maximum of 60 W of power to a connected notebook PC when used as an external monitor.

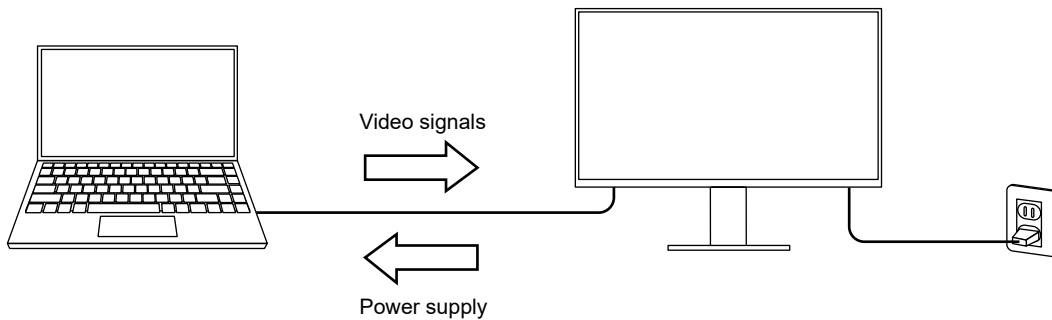

Note

- To use the charging function, the connected device must be equipped with a USB Type-C connector and support device charging by using USB Power Delivery. Charging may not be possible depending on the used external device.
- To use video signal transfer with USB Type-C, the connected device must be equipped with a USB Type-C connector and support video signal transfer by using USB Type-C.
- Connected devices can be charged even when the monitor is in power saving mode.

● Support for Color Management Software “ColorNavigator 7” and Color Matching Tool for Photo Prints “Quick Color Match”

By using this product with the “ColorNavigator 7” or “Quick Color Match” software designed especially for the ColorEdge series, you can optimize the performance of this monitor and make it even easier to use.

• ColorNavigator 7

The sensor and ColorNavigator 7 can be used to calibrate the monitor and to create or edit adjustment targets. The sensor is not included with this product and is available as an optional product.

• Quick Color Match

This software can be used to match the colors of the monitor screen and photo prints with ease. You must have a printer and retouch software that are compatible with this software.

1-2. Controls and Functions

● Front

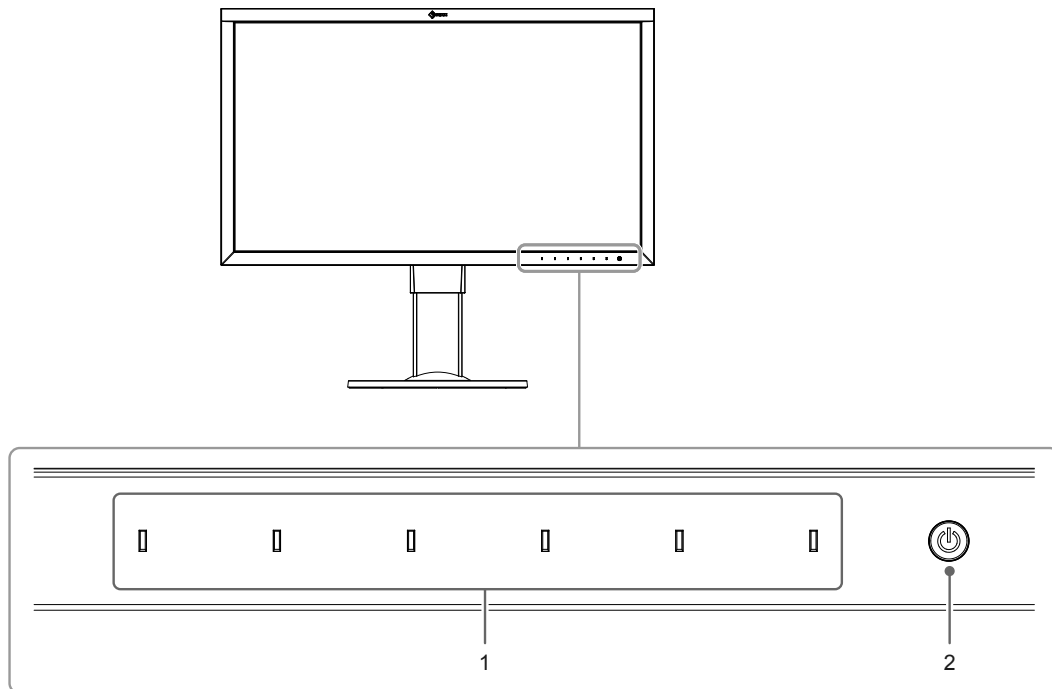

1. Operation switches	Displays menus. Operate the switches according to the operation guide. Touch the switch to display its menu. The switch indicators are lit white when you turn on the power.
2. Power switch	Turns the power on or off. Touch the switch to turn the power on. The switch indicator is lit when you turn the power on. The indicator color differs depending on the monitor's operation status. White : Normal operating mode Orange : Power saving mode OFF : Power off

● Rear

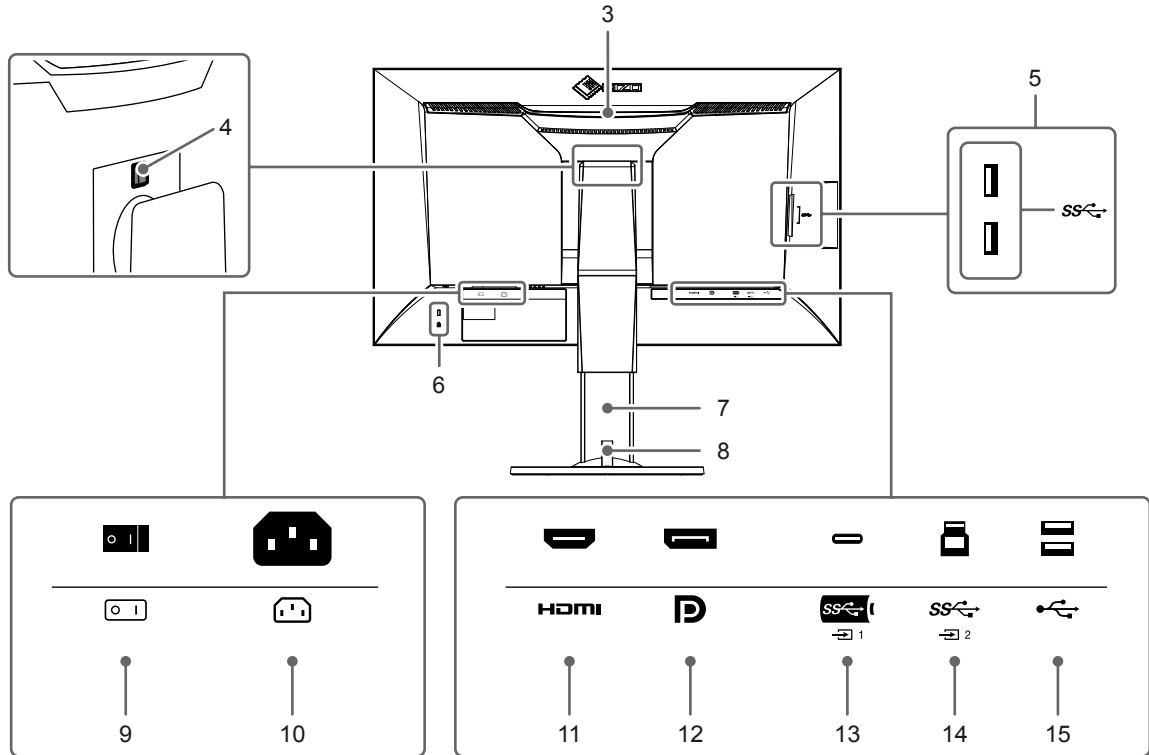

3. Transportation handle	This handle is used for transportation. Attention • Firmly grasp and hold the monitor by the bottom while grabbing the handle, and carefully convey the monitor so as not to drop it.
4. Lock button	Use this button when removing the stand from the monitor.
5. USB Type-A connector (USB downstream port)	Connects to a peripheral USB device. Supports USB 3.1 Gen 1. This is a blue-colored connector.
6. Security lock slot	Complies with Kensington's MicroSaver security system.
7. Stand*1	Adjusts the height and angle (tilt and swivel) of the monitor.
8. Cable holder	Covers the monitor cables. For details on attaching the cable holder, see "8-1. Attaching/Detaching the Cable Holder" (page 41).
9. Main power switch	Turns the main power on or off. : On, ○ : Off
10. Power connector	Connects the power cord.
11. HDMI connector	Connects to an external device that has HDMI output.
12. DisplayPort connector	Connects to an external device that has DisplayPort output.
13. USB Type-C connector (USB upstream port)	Connects a device that supports USB Type-C.
14. USB Type-B connector (USB upstream port)	Connects to the USB cable when using software that requires a USB connection, or when using the USB Hub function. This is a blue-colored connector.
15. USB Type-A connector (USB downstream port)	Connects to a peripheral USB device. Supports USB 2.0.

*1 An optional arm (or an optional stand) can be attached by removing the stand section (refer to ["7-2. Attaching the Optional Arm"](#) (page 40)).

1-3. Supported Resolutions

The monitor supports the following resolutions.

● DisplayPort

Resolution	Scan ^{*1}	Vertical Scan Frequency	Version 1.1 ^{*2}	Version 1.2, Version 1.2 / YUV ^{*2}	YCbCr 4:4:4	YCbCr 4:2:2	RGB 4:4:4
640 x 480	P	59.940 Hz	√	√	10 / 8 bit	10 / 8 bit	10 / 8 bit
640 x 480	P	60.000 Hz	√	√	10 / 8 bit	10 / 8 bit	10 / 8 bit
720 x 400	P	70.087 Hz	√	√	10 / 8 bit	10 / 8 bit	10 / 8 bit
720 x 480	P	59.940 Hz	√	√	10 / 8 bit	10 / 8 bit	10 / 8 bit
720 x 480	P	59.941 Hz	√	√	10 / 8 bit	10 / 8 bit	10 / 8 bit
720 x 480	P	60.000 Hz	√	√	10 / 8 bit	10 / 8 bit	10 / 8 bit
720 x 576	P	50.000 Hz	√	√	10 / 8 bit	10 / 8 bit	10 / 8 bit
800 x 600	P	60.317 Hz	√	√	10 / 8 bit	10 / 8 bit	10 / 8 bit
1024 x 768	P	60.004 Hz	√	√	10 / 8 bit	10 / 8 bit	10 / 8 bit
1280 x 720	P	50.000 Hz	√	√	10 / 8 bit	10 / 8 bit	10 / 8 bit
1280 x 720	P	59.940 Hz	√	√	10 / 8 bit	10 / 8 bit	10 / 8 bit
1280 x 720	P	60.000 Hz	√	√	10 / 8 bit	10 / 8 bit	10 / 8 bit
1280 x 960	P	60.000 Hz	√	√	10 / 8 bit	10 / 8 bit	10 / 8 bit
1280 x 1024	P	60.020 Hz	√	√	10 / 8 bit	10 / 8 bit	10 / 8 bit
1600 x 1200	P	60.000 Hz	√	√	10 / 8 bit	10 / 8 bit	10 / 8 bit
1680 x 1050	P	59.883 Hz	√	√	10 / 8 bit	10 / 8 bit	10 / 8 bit
1680 x 1050	P	59.954 Hz	√	√	10 / 8 bit	10 / 8 bit	10 / 8 bit
1920 x 1080	P	23.976 Hz	√	√	10 / 8 bit	10 / 8 bit	10 / 8 bit
1920 x 1080	P	24.000 Hz	√	√	10 / 8 bit	10 / 8 bit	10 / 8 bit
1920 x 1080	P	25.000 Hz	√	√	10 / 8 bit	10 / 8 bit	10 / 8 bit
1920 x 1080	P	29.970 Hz	√	√	10 / 8 bit	10 / 8 bit	10 / 8 bit
1920 x 1080	P	30.000 Hz	√	√	10 / 8 bit	10 / 8 bit	10 / 8 bit
1920 x 1080	P	50.000 Hz	√	√	10 / 8 bit	10 / 8 bit	10 / 8 bit
1920 x 1080	I	50.000 Hz	√	√	10 / 8 bit	10 / 8 bit	10 / 8 bit
1920 x 1080	P	59.940 Hz	√	√	10 / 8 bit	10 / 8 bit	10 / 8 bit
1920 x 1080	I	59.940 Hz	√	√	10 / 8 bit	10 / 8 bit	10 / 8 bit
1920 x 1080	P	59.963 Hz	√	√	10 / 8 bit	10 / 8 bit	10 / 8 bit
1920 x 1080	P	60.000 Hz	√	√	10 / 8 bit	10 / 8 bit	10 / 8 bit
1920 x 1080	I	60.000 Hz	√	√	10 / 8 bit	10 / 8 bit	10 / 8 bit
1920 x 1200	P	59.885 Hz	√	√	10 / 8 bit	10 / 8 bit	10 / 8 bit
1920 x 1200	P	59.950 Hz	√	√	10 / 8 bit	10 / 8 bit	10 / 8 bit
2048 x 1080	P	24.000 Hz	√	√	10 / 8 bit	10 / 8 bit	10 / 8 bit
2048 x 1080	P	48.000 Hz	√	√	10 / 8 bit	10 / 8 bit	10 / 8 bit
2048 x 1152	P	60.000 Hz	√	√	10 / 8 bit	10 / 8 bit	10 / 8 bit
2560 x 1080	P	23.976 Hz	√	√	10 / 8 bit	10 / 8 bit	10 / 8 bit
2560 x 1080	P	24.000 Hz	√	√	10 / 8 bit	10 / 8 bit	10 / 8 bit
2560 x 1080	P	25.000 Hz	√	√	10 / 8 bit	10 / 8 bit	10 / 8 bit
2560 x 1080	P	29.970 Hz	√	√	10 / 8 bit	10 / 8 bit	10 / 8 bit
2560 x 1080	P	30.000 Hz	√	√	10 / 8 bit	10 / 8 bit	10 / 8 bit
2560 x 1080	P	50.000 Hz	√	√	10 / 8 bit	10 / 8 bit	10 / 8 bit
2560 x 1080	P	59.940 Hz	√	√	10 / 8 bit	10 / 8 bit	10 / 8 bit
2560 x 1080	P	60.000 Hz	√	√	10 / 8 bit	10 / 8 bit	10 / 8 bit
2560 x 1440	P	29.935 Hz	√	√	10 / 8 bit	10 / 8 bit	10 / 8 bit
2560 x 1440	P	59.951 Hz	√	√	10 / 8 bit	10 / 8 bit	10 / 8 bit
2560 x 1600	P	59.972 Hz	√	√	10 / 8 bit	10 / 8 bit	10 / 8 bit
3840 x 2160 ^{*3}	P	23.976 Hz	√	√	10 / 8 bit	10 / 8 bit	10 / 8 bit
3840 x 2160 ^{*3}	P	23.999 Hz	√	√	10 / 8 bit	10 / 8 bit	10 / 8 bit

Resolution	Scan ^{*1}	Vertical Scan Frequency	Version 1.1 ^{*2}	Version 1.2, Version 1.2 / YUV ^{*2}	YCbCr 4:4:4	YCbCr 4:2:2	RGB 4:4:4
3840 x 2160 ^{*3}	P	24.000 Hz	√	√	10 / 8 bit	10 / 8 bit	10 / 8 bit
3840 x 2160 ^{*3}	P	24.989 Hz	√	√	10 / 8 bit	10 / 8 bit	10 / 8 bit
3840 x 2160 ^{*3}	P	25.000 Hz	√	√	10 / 8 bit	10 / 8 bit	10 / 8 bit
3840 x 2160 ^{*3}	P	29.970 Hz	√	√	10 / 8 bit	10 / 8 bit	10 / 8 bit
3840 x 2160 ^{*3}	P	29.981 Hz	√	√	10 / 8 bit	10 / 8 bit	10 / 8 bit
3840 x 2160 ^{*3}	P	30.000 Hz	√	√	10 / 8 bit	10 / 8 bit	10 / 8 bit
3840 x 2160 ^{*3}	P	50.000 Hz	-	√	8 bit	8 bit	8 bit
3840 x 2160 ^{*3}	P	59.940 Hz	-	√	8 bit	8 bit	8 bit
3840 x 2160 ^{*3}	P	59.997 Hz	-	√	10 / 8 bit	10 / 8 bit	10 / 8 bit
3840 x 2160 ^{*3}	P	60.000 Hz	-	√	8 bit	8 bit	8 bit

*1 P: Progressive, I: Interlace

*2 "Signal Format" (page 35) must be set.

*3 Recommended resolution

● HDMI

Resolution	Scan ^{*1}	Vertical Scan Frequency	4K 30Hz ^{*2}	4K 60Hz, 4K 60Hz / YUV ^{*2}	YCbCr 4:4:4	YCbCr 4:2:2	YCbCr 4:2:0	RGB 4:4:4
640 x 480	P	59.940 Hz	√	√	12 / 10 / 8 bit	12 / 10 / 8 bit	-	12 / 10 / 8 bit
640 x 480	P	60.000 Hz	√	√	12 / 10 / 8 bit	12 / 10 / 8 bit	-	12 / 10 / 8 bit
720 x 400	P	70.087 Hz	√	√	12 / 10 / 8 bit	12 / 10 / 8 bit	-	12 / 10 / 8 bit
720 x 480	P	59.940 Hz	√	√	12 / 10 / 8 bit	12 / 10 / 8 bit	-	12 / 10 / 8 bit
720 x 480	I	59.940 Hz	√	√	12 / 10 / 8 bit	12 / 10 / 8 bit	-	12 / 10 / 8 bit
720 x 480	P	59.941 Hz	√	√	12 / 10 / 8 bit	12 / 10 / 8 bit	-	12 / 10 / 8 bit
720 x 480	P	60.000 Hz	√	√	12 / 10 / 8 bit	12 / 10 / 8 bit	-	12 / 10 / 8 bit
720 x 480	I	60.000 Hz	√	√	12 / 10 / 8 bit	12 / 10 / 8 bit	-	12 / 10 / 8 bit
720 x 576	P	50.000 Hz	√	√	12 / 10 / 8 bit	12 / 10 / 8 bit	-	12 / 10 / 8 bit
720 x 576	I	50.000 Hz	√	√	12 / 10 / 8 bit	12 / 10 / 8 bit	-	12 / 10 / 8 bit
800 x 600	P	60.317 Hz	√	√	12 / 10 / 8 bit	12 / 10 / 8 bit	-	12 / 10 / 8 bit
1024 x 768	P	60.004 Hz	√	√	12 / 10 / 8 bit	12 / 10 / 8 bit	-	12 / 10 / 8 bit
1280 x 720	P	50.000 Hz	√	√	12 / 10 / 8 bit	12 / 10 / 8 bit	-	12 / 10 / 8 bit
1280 x 720	P	59.940 Hz	√	√	12 / 10 / 8 bit	12 / 10 / 8 bit	-	12 / 10 / 8 bit
1280 x 720	P	60.000 Hz	√	√	12 / 10 / 8 bit	12 / 10 / 8 bit	-	12 / 10 / 8 bit
1280 x 960	P	60.000 Hz	√	√	12 / 10 / 8 bit	12 / 10 / 8 bit	-	12 / 10 / 8 bit
1280 x 1024	P	60.020 Hz	√	√	12 / 10 / 8 bit	12 / 10 / 8 bit	-	12 / 10 / 8 bit
1600 x 1200	P	60.000 Hz	√	√	12 / 10 / 8 bit	12 / 10 / 8 bit	-	12 / 10 / 8 bit

Resolution	Scan ^{*1}	Vertical Scan Frequency	4K 30Hz ^{*2}	4K 60Hz, 4K 60Hz / YUV ^{*2}	YCbCr 4:4:4	YCbCr 4:2:2	YCbCr 4:2:0	RGB 4:4:4
1680 x 1050	P	59.883 Hz	√	√	12 / 10 / 8 bit	12 / 10 / 8 bit	-	12 / 10 / 8 bit
1680 x 1050	P	59.954 Hz	√	√	12 / 10 / 8 bit	12 / 10 / 8 bit	-	12 / 10 / 8 bit
1920 x 1080	P	23.976 Hz	√	√	12 / 10 / 8 bit	12 / 10 / 8 bit	-	12 / 10 / 8 bit
1920 x 1080	P	24.000 Hz	√	√	12 / 10 / 8 bit	12 / 10 / 8 bit	-	12 / 10 / 8 bit
1920 x 1080	P	25.000 Hz	√	√	12 / 10 / 8 bit	12 / 10 / 8 bit	-	12 / 10 / 8 bit
1920 x 1080	P	29.970 Hz	√	√	12 / 10 / 8 bit	12 / 10 / 8 bit	-	12 / 10 / 8 bit
1920 x 1080	P	30.000 Hz	√	√	12 / 10 / 8 bit	12 / 10 / 8 bit	-	12 / 10 / 8 bit
1920 x 1080	P	50.000 Hz	√	√	12 / 10 / 8 bit	12 / 10 / 8 bit	-	12 / 10 / 8 bit
1920 x 1080	I	50.000 Hz	√	√	12 / 10 / 8 bit	12 / 10 / 8 bit	-	12 / 10 / 8 bit
1920 x 1080	P	59.940 Hz	√	√	12 / 10 / 8 bit	12 / 10 / 8 bit	-	12 / 10 / 8 bit
1920 x 1080	I	59.940 Hz	√	√	12 / 10 / 8 bit	12 / 10 / 8 bit	-	12 / 10 / 8 bit
1920 x 1080	P	59.963 Hz	√	√	12 / 10 / 8 bit	12 / 10 / 8 bit	-	12 / 10 / 8 bit
1920 x 1080	P	60.000 Hz	√	√	12 / 10 / 8 bit	12 / 10 / 8 bit	-	12 / 10 / 8 bit
1920 x 1080	I	60.000 Hz	√	√	12 / 10 / 8 bit	12 / 10 / 8 bit	-	12 / 10 / 8 bit
1920 x 1200	P	59.885 Hz	√	√	12 / 10 / 8 bit	12 / 10 / 8 bit	-	12 / 10 / 8 bit
1920 x 1200	P	59.950 Hz	√	√	12 / 10 / 8 bit	12 / 10 / 8 bit	-	12 / 10 / 8 bit
2048 x 1080	P	24.000 Hz	√	√	12 / 10 / 8 bit	12 / 10 / 8 bit	-	12 / 10 / 8 bit
2048 x 1080	P	48.000 Hz	√	√	12 / 10 / 8 bit	12 / 10 / 8 bit	-	12 / 10 / 8 bit
2048 x 1152	P	60.000 Hz	√	√	12 / 10 / 8 bit	12 / 10 / 8 bit	-	12 / 10 / 8 bit
2560 x 1080	P	23.976 Hz	-	√	12 / 10 / 8 bit	12 / 10 / 8 bit	-	12 / 10 / 8 bit
2560 x 1080	P	24.000 Hz	-	√	12 / 10 / 8 bit	12 / 10 / 8 bit	-	12 / 10 / 8 bit
2560 x 1080	P	25.000 Hz	-	√	12 / 10 / 8 bit	12 / 10 / 8 bit	-	12 / 10 / 8 bit
2560 x 1080	P	29.970 Hz	-	√	12 / 10 / 8 bit	12 / 10 / 8 bit	-	12 / 10 / 8 bit
2560 x 1080	P	30.000 Hz	-	√	12 / 10 / 8 bit	12 / 10 / 8 bit	-	12 / 10 / 8 bit
2560 x 1080	P	50.000 Hz	-	√	12 / 10 / 8 bit	12 / 10 / 8 bit	-	12 / 10 / 8 bit
2560 x 1080	P	59.940 Hz	-	√	12 / 10 / 8 bit	12 / 10 / 8 bit	-	12 / 10 / 8 bit
2560 x 1080	P	60.000 Hz	-	√	12 / 10 / 8 bit	12 / 10 / 8 bit	-	12 / 10 / 8 bit
2560 x 1440	P	29.935 Hz	√	√	12 / 10 / 8 bit	12 / 10 / 8 bit	-	12 / 10 / 8 bit

Resolution	Scan ^{*1}	Vertical Scan Frequency	4K 30Hz ^{*2}	4K 60Hz, 4K 60Hz / YUV ^{*2}	YCbCr 4:4:4	YCbCr 4:2:2	YCbCr 4:2:0	RGB 4:4:4
2560 x 1440	P	59.951 Hz	√	-	8 bit	12 / 10 / 8 bit	-	8 bit
2560 x 1600	P	59.972 Hz	√	-	8 bit	12 / 10 / 8 bit	-	8 bit
3840 x 2160 ^{*3}	P	23.976 Hz	√	√	12 / 10 / 8 bit	12 / 10 / 8 bit	-	12 / 10 / 8 bit
3840 x 2160 ^{*3}	P	24.000 Hz	√	√	12 / 10 / 8 bit	12 / 10 / 8 bit	-	12 / 10 / 8 bit
3840 x 2160 ^{*3}	P	25.000 Hz	√	√	12 / 10 / 8 bit	12 / 10 / 8 bit	-	12 / 10 / 8 bit
3840 x 2160 ^{*3}	P	29.970 Hz	√	√	12 / 10 / 8 bit	12 / 10 / 8 bit	-	12 / 10 / 8 bit
3840 x 2160 ^{*3}	P	30.000 Hz	√	√	12 / 10 / 8 bit	12 / 10 / 8 bit	-	12 / 10 / 8 bit
3840 x 2160 ^{*3}	P	50.000 Hz	-	√	8 bit	12 / 10 / 8 bit	12 / 10 / 8 bit	8 bit
3840 x 2160 ^{*3}	P	59.940 Hz	-	√	8 bit	12 / 10 / 8 bit	12 / 10 / 8 bit	8 bit
3840 x 2160 ^{*3}	P	60.000 Hz	-	√	8 bit	12 / 10 / 8 bit	12 / 10 / 8 bit	8 bit

*1 P: Progressive, I: Interlace

*2 "Signal Format" (page 35) must be set.

*3 Recommended resolution

● USB Type-C

Resolution	Scan ^{*1}	Vertical Scan Frequency	4K 30Hz / USB3.1 ^{*2}	4K 60Hz / USB2.0, 4K 60Hz / USB2.0 / YUV ^{*2}	YCbCr 4:4:4	YCbCr 4:2:2
640 x 480	P	59.940 Hz	√	√	10 / 8 bit	10 / 8 bit
640 x 480	P	60.000 Hz	√	√	10 / 8 bit	10 / 8 bit
720 x 400	P	70.087 Hz	√	√	10 / 8 bit	10 / 8 bit
720 x 480	P	59.940 Hz	√	√	10 / 8 bit	10 / 8 bit
720 x 480	P	59.941 Hz	√	√	10 / 8 bit	10 / 8 bit
720 x 480	P	60.000 Hz	√	√	10 / 8 bit	10 / 8 bit
720 x 576	P	50.000 Hz	√	√	10 / 8 bit	10 / 8 bit
800 x 600	P	60.317 Hz	√	√	10 / 8 bit	10 / 8 bit
1024 x 768	P	60.004 Hz	√	√	10 / 8 bit	10 / 8 bit
1280 x 720	P	50.000 Hz	√	√	10 / 8 bit	10 / 8 bit
1280 x 720	P	59.940 Hz	√	√	10 / 8 bit	10 / 8 bit
1280 x 720	P	60.000 Hz	√	√	10 / 8 bit	10 / 8 bit
1280 x 960	P	60.000 Hz	√	√	10 / 8 bit	10 / 8 bit
1280 x 1024	P	60.020 Hz	√	√	10 / 8 bit	10 / 8 bit
1600 x 1200	P	60.000 Hz	√	√	10 / 8 bit	10 / 8 bit
1680 x 1050	P	59.883 Hz	√	√	10 / 8 bit	10 / 8 bit
1680 x 1050	P	59.954 Hz	√	√	10 / 8 bit	10 / 8 bit
1920 x 1080	P	23.976 Hz	√	√	10 / 8 bit	10 / 8 bit
1920 x 1080	P	24.000 Hz	√	√	10 / 8 bit	10 / 8 bit
1920 x 1080	P	25.000 Hz	√	√	10 / 8 bit	10 / 8 bit
1920 x 1080	P	29.970 Hz	√	√	10 / 8 bit	10 / 8 bit
1920 x 1080	P	30.000 Hz	√	√	10 / 8 bit	10 / 8 bit
1920 x 1080	P	50.000 Hz	√	√	10 / 8 bit	10 / 8 bit

Resolution	Scan ^{*1}	Vertical Scan Frequency	4K 30Hz / USB3.1 ^{*2}	4K 60Hz / USB2.0, 4K 60Hz / USB2.0 / YUV ^{*2}	YCbCr 4:4:4	YCbCr 4:2:2
1920 x 1080	I	50.000 Hz	√	√	10 / 8 bit	10 / 8 bit
1920 x 1080	P	59.940 Hz	√	√	10 / 8 bit	10 / 8 bit
1920 x 1080	I	59.940 Hz	√	√	10 / 8 bit	10 / 8 bit
1920 x 1080	P	59.963 Hz	√	√	10 / 8 bit	10 / 8 bit
1920 x 1080	P	60.000 Hz	√	√	10 / 8 bit	10 / 8 bit
1920 x 1080	I	60.000 Hz	√	√	10 / 8 bit	10 / 8 bit
1920 x 1200	P	59.885 Hz	√	√	10 / 8 bit	10 / 8 bit
1920 x 1200	P	59.950 Hz	√	√	10 / 8 bit	10 / 8 bit
2048 x 1080	P	24.000 Hz	√	√	10 / 8 bit	10 / 8 bit
2048 x 1080	P	48.000 Hz	√	√	10 / 8 bit	10 / 8 bit
2048 x 1152	P	60.000 Hz	√	√	10 / 8 bit	10 / 8 bit
2560 x 1080	P	23.976 Hz	√	√	10 / 8 bit	10 / 8 bit
2560 x 1080	P	24.000 Hz	√	√	10 / 8 bit	10 / 8 bit
2560 x 1080	P	25.000 Hz	√	√	10 / 8 bit	10 / 8 bit
2560 x 1080	P	29.970 Hz	√	√	10 / 8 bit	10 / 8 bit
2560 x 1080	P	30.000 Hz	√	√	10 / 8 bit	10 / 8 bit
2560 x 1080	P	50.000 Hz	√	√	10 / 8 bit	10 / 8 bit
2560 x 1080	P	59.940 Hz	√	√	10 / 8 bit	10 / 8 bit
2560 x 1080	P	60.000 Hz	√	√	10 / 8 bit	10 / 8 bit
2560 x 1440	P	29.935 Hz	√	√	10 / 8 bit	10 / 8 bit
2560 x 1440	P	59.951 Hz	√	√	10 / 8 bit	10 / 8 bit
2560 x 1600	P	59.972 Hz	√	√	10 / 8 bit	10 / 8 bit
3840 x 2160 ^{*3}	P	23.976 Hz	√	√	10 / 8 bit	10 / 8 bit
3840 x 2160 ^{*3}	P	23.999 Hz	√	√	10 / 8 bit	10 / 8 bit
3840 x 2160 ^{*3}	P	24.000 Hz	√	√	10 / 8 bit	10 / 8 bit
3840 x 2160 ^{*3}	P	24.989 Hz	√	√	10 / 8 bit	10 / 8 bit
3840 x 2160 ^{*3}	P	25.000 Hz	√	√	10 / 8 bit	10 / 8 bit
3840 x 2160 ^{*3}	P	29.970 Hz	√	√	10 / 8 bit	10 / 8 bit
3840 x 2160 ^{*3}	P	29.981 Hz	√	√	10 / 8 bit	10 / 8 bit
3840 x 2160 ^{*3}	P	30.000 Hz	√	√	10 / 8 bit	10 / 8 bit
3840 x 2160 ^{*3}	P	50.000 Hz	-	√	8 bit	8 bit
3840 x 2160 ^{*3}	P	59.940 Hz	-	√	8 bit	8 bit
3840 x 2160 ^{*3}	P	59.997 Hz	-	√	10 / 8 bit	10 / 8 bit
3840 x 2160 ^{*3}	P	60.000 Hz	-	√	8 bit	8 bit

*1 P: Progressive, I: Interlace

*2 "Signal Format" (page 35) must be set.

*3 Recommended resolution

1-4. Changing the PC Display Settings

If the screen is not properly displayed after connecting the monitor to a PC, follow the procedure below to change the PC display settings.

● Windows 10

1. Right-click anywhere on the desktop except for on icons to display the menu.
2. From the displayed menu, click "Display settings" to display the "Settings" screen.
3. If there are multiple monitors including the notebook PC screen connected to the computer, select "Extend these displays" from the "Multiple displays" menu, and click "Keep changes" in the confirmation screen. After changing the settings, select the monitor from the "Select and arrange display" menu.
4. By checking the option "Make this my main display" from the "Multiple displays" menu, the display of the monitor will be corrected.
5. Confirm that the monitor's recommended resolution is set in the "Resolution" menu (the term (Recommended) should be displayed after the resolution).
6. To change the size of letters and icons, select the preferred magnification level from the scaling (%) menu.
7. When after changing these settings a message is displayed that prompts you to sign out, sign out once and then sign in again.

● Windows 8.1 / Windows 7

* For Windows 8.1, click the "Desktop" tile on the Start Screen to display the desktop.

1. Right-click anywhere on the desktop except for on icons to display the menu.
2. From the displayed menu, click "Screen resolution" to display the settings screen.
3. If there are multiple monitors including the notebook PC screen connected to the computer, select "Extend these displays" from the "Multiple displays" menu, and click "Apply". In the confirmation screen, click "Keep changes".
4. Select the monitor from the "Display" menu, check the option "Make this my main display", and click "Apply". The display of the monitor will be corrected.
5. Confirm that the monitor's recommended resolution is set in the "Resolution" menu (the term (Recommended) should be displayed after the resolution).
6. To change the size of letters and icons, click "Make text and other items larger or smaller", select the preferred size from the settings screen, and click "Apply".
7. When after changing settings a message is displayed that prompts you to sign out or log off, sign out or log off once and then sign in or log on again.

● macOS

1. Select "System Preferences" from the Apple menu.
2. When the "System Preferences" panel is displayed, click "Displays".
3. If there are multiple monitors including the notebook PC screen connected to the computer, open the "Arrangement" tab and confirm that "Mirror displays" is not selected. If it is selected, clear it.
4. Select the "Display" tab, and confirm that "Default for display" of "Resolution" is selected. If it is not selected, select it. This sets the correct resolution. Close the "System Preferences" menu. If there are multiple monitors including the notebook PC screen connected to the computer, change the settings for each monitor by using "Display".
5. To select a different resolution, select "Scaled", select a resolution from the resolution list (displayed in list or icon format), and close the panel.

Chapter 2 Basic Adjustments/Settings

This chapter describes the basic functions that can be set by touching the switches on the front of the monitor.

For advanced adjustment and setting procedures using the Setting menu, see “[Chapter 4 Advanced Adjustments/Settings](#)” (page 22).

2-1. Switch Operation Method

1. Displaying the operation guide

1. Touch any switch (except ).
The operation guide appears on the screen.

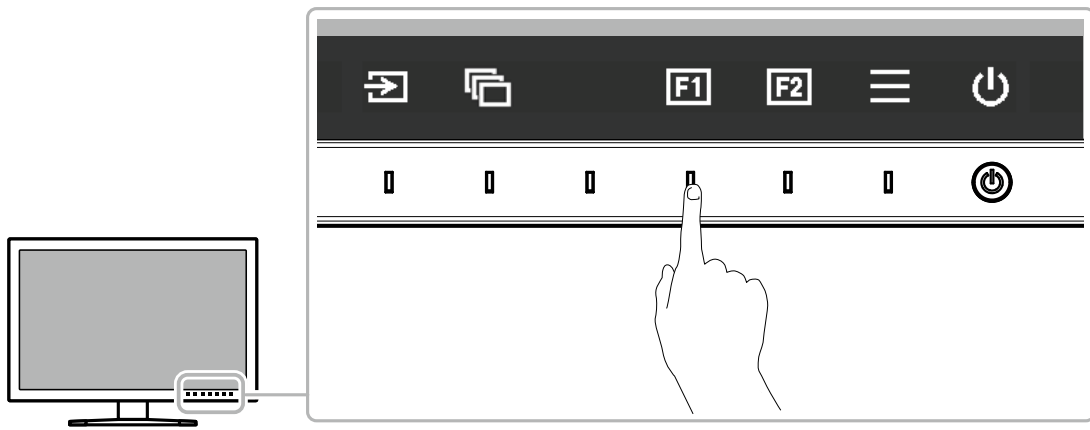

2. Setting

1. Touch a switch for setting.
The Setting menu appears.
2. Use the switches to adjust/set the selected item, and then select  to confirm.









3. Exiting

1. Select  to exit the menu.

Note

- The contents of the guide will differ depending on the selected menu or status.

● Operation Guide Icons

Icon	Description
	Switches the input signal.
	Switches the color mode.
	Executes the function assigned to Custom Key 1.
	Executes the function assigned to Custom Key 2.
	Displays the Setting menu.
	Returns to the previous screen.
	Moves the cursor.
	Executes the selected operation.
	Turns the monitor's power on or off.

2-2. Switching Input Signals

When a monitor has multiple signal inputs, the signal to display on-screen can be changed. Touch any switch, select , and use  or  to select the input signal you want to display.

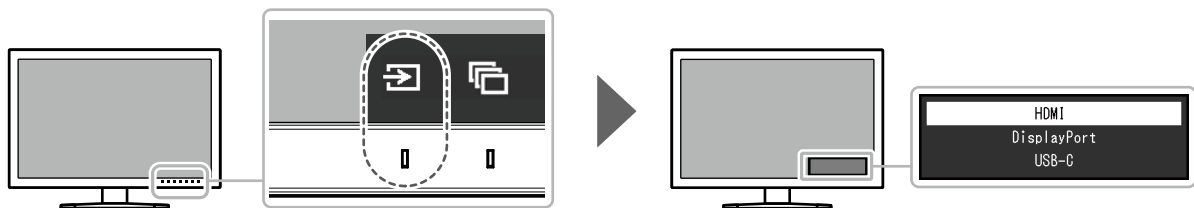

2-3. Switching the Display Mode (color mode)

This function allows easy selection of a display mode according to monitor application. Touch any switch, select , and use  or  to select the color mode you want to use.

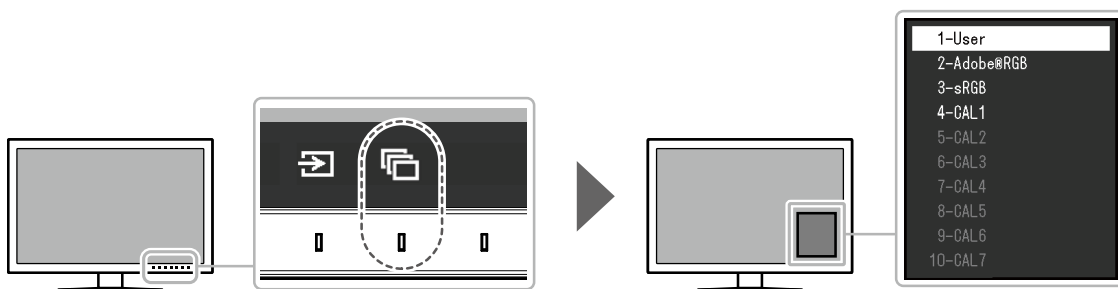

● Display Modes

Color Mode	Purpose
User	Select for configuring color settings according to your preference.
Adobe®RGB	Suitable for color matching with Adobe®RGB compatible peripherals.
sRGB	Suitable for color matching with sRGB compatible peripherals.
CAL1 CAL2 CAL3 CAL4 CAL5 CAL6 CAL7	Displays the screen adjusted by ColorNavigator 7. Note <ul style="list-style-type: none">• Use ColorNavigator 7 to set CAL1 to CAL7. This cannot be changed on the monitor's Setting menu.• CAL2 to CAL7 are disabled in the default settings.

Note

- You can set the color mode for each input signal.
 - You can disable specific color mode selections. For more information, see [“Mode Skip” \(page 31\)](#).
-

Chapter 3 Custom Key Settings

You can assign functions to the custom keys to easily start specified functions.
This chapter describes how to operate the custom keys and how to assign functions to the custom keys.



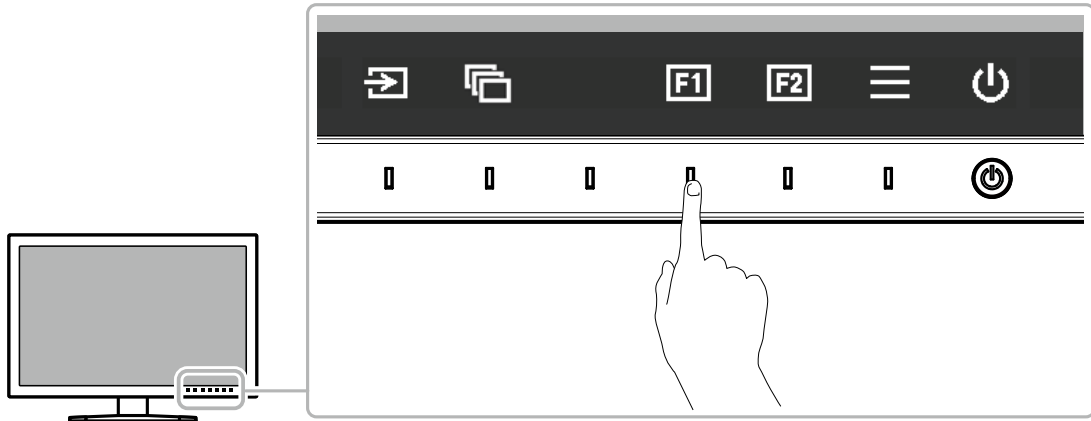

3-1. Basic Operation of the Custom Keys

1. Displaying the operation guide

1. Touch any switch (except ).
The operation guide appears.



2. Execute

1. Select  or  .
The function assigned to  or  is executed.

Note

- If you touch a custom key to which no function has been assigned, the menu for assigning a function to that custom key appears.

3-2. Assigning a Function to a Custom Key

1. Displaying the operation guide

1. Touch any switch (except ).
The operation guide appears.

2. Setting

1. Select  .
The Setting menu appears.

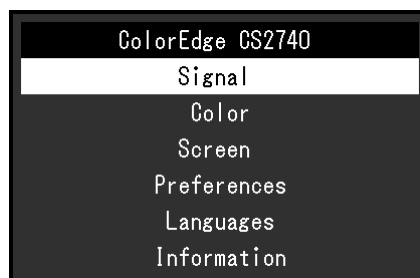

- Use **^** **v** to select "Preferences", and then select **✓**.
The Preferences menu appears.

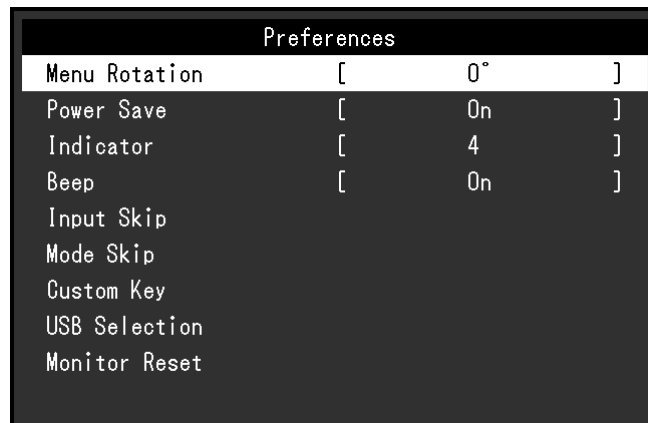

- Use **^** **v** to select "Custom Key", and then select **✓**.
The Custom Key menu appears.



- Use **^** **v** to select the custom key to which you want to assign a function, and then select **✓**.
The menu for assigning a function appears.



For more information about these functions, see ["Functions that can be Assigned to Custom Keys"](#) (page 21).

- Use **^** **v** to select the function that you want to assign, and then select **✓**.
That function is assigned to the custom key.

3. Exiting

- Press **x** several times.
The Setting menu exits.

● Functions that can be Assigned to Custom Keys

Function	Description
Off	Disables the custom key even when it is touched.
Brightness	Set the brightness. For more information, see page 26 .
Prev. Color Mode	You can return to the previous color mode. This is convenient for checking the differences between two color modes.
Information	<p>You can view the input signal information and color information. The following information is displayed:</p> <ol style="list-style-type: none"> Resolution / Vertical scan frequency / Color depth Color format / Input range <div data-bbox="678 555 1252 667" style="border: 1px solid black; padding: 5px; margin: 10px 0;"> <p style="text-align: center;">DisplayPort (User)</p> <p>1 — 3840 X 2160 24.00Hz 8bit</p> <p>2 — RGB Full Range</p> </div> <p>Note</p> <ul style="list-style-type: none"> You can check the monitor information under “Information” (page 32) on the Setting menu.

Chapter 4 Advanced Adjustments/Settings

This chapter describes the advanced monitor adjustment and setting procedures using the Setting menu. For the basic setting functions using the switches on the front of the monitor, see "[Chapter 2 Basic Adjustments/Settings](#)" (page 16).

4-1. Basic Operation of the Setting Menu

1. Menu display

1. Touch any switch (except ).
The operation guide appears.

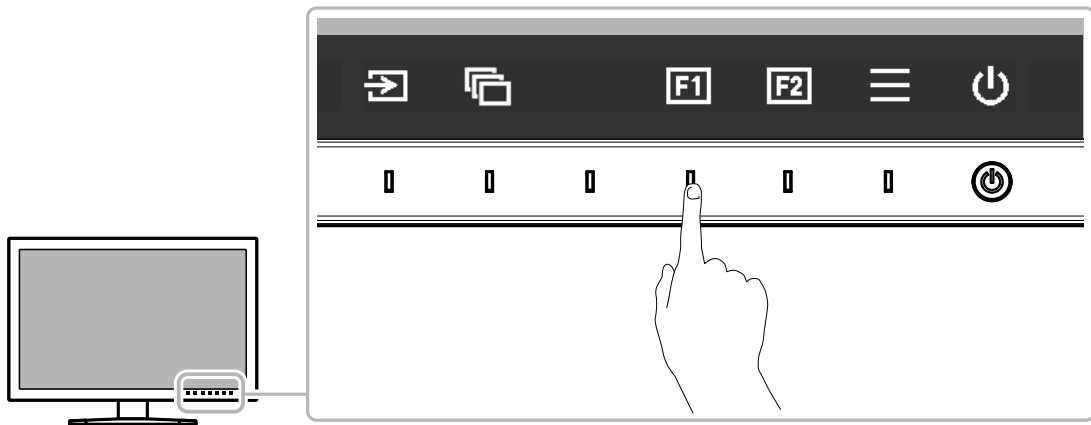

2. Select  .
The Setting menu appears.

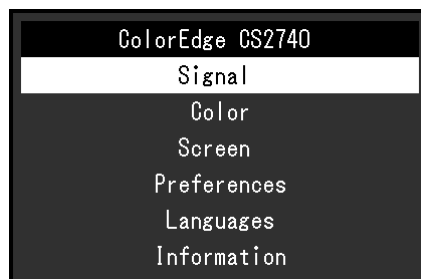

2. Adjusting/setting

1. Choose a menu to adjust/set with **▲ ▼**, and then select **✓**.
The Sub menu appears.

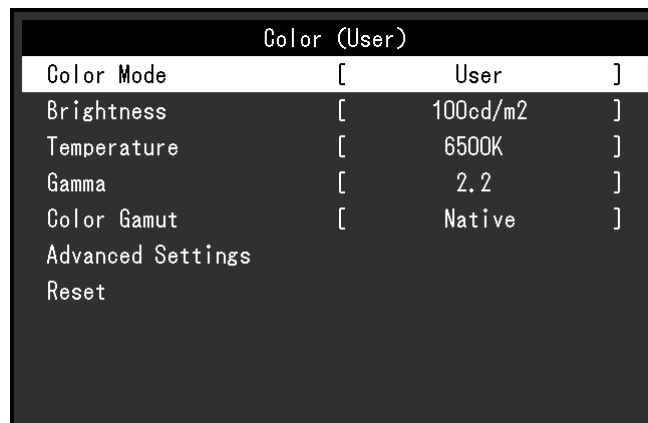

2. Choose an item to adjust/set with **▲ ▼**, and then press **✓**.
The Adjustment/Setting menu appears.



3. Adjust/set the selected item with **< >**, and then select **✓**.
The Sub menu appears.

Selecting **✕** during adjustment/setting will cancel the adjustment/setting and restore the state prior to making changes.

3. Exiting

1. Select **✕**.
The Setting menu appears.
2. Select **✕**.
The Setting menu exits.

Note

- The contents of the guide will differ depending on the selected menu or status.
-

4-2. Setting Menu Functions

● Signal

The signal settings are used to configure advanced settings for input signals, such as the screen display size and color format.

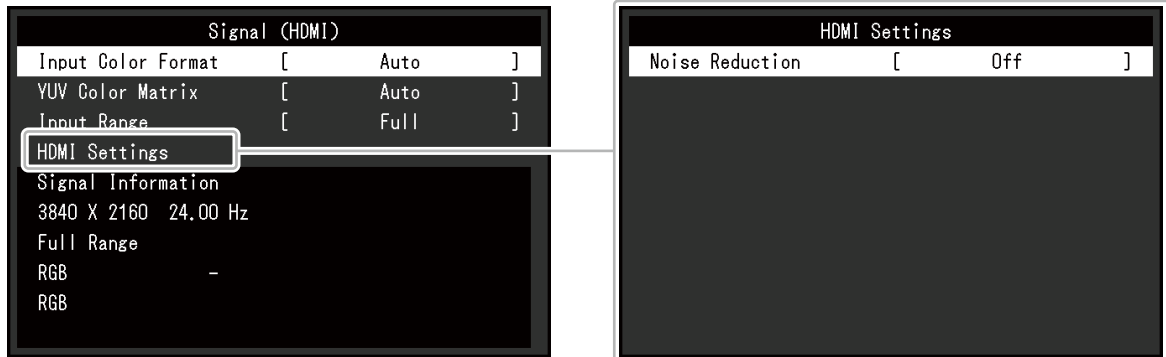

Function	Settings	Description
Input Color Format	Auto YUV*1 YUV 4:2:2*2 YUV 4:4:4*2 RGB	The color space of the input signal can be specified. Try changing this setting if colors are not displayed correctly. Normally, select "Auto".

*1 Only enabled during DisplayPort or USB Type-C input

*2 Only enabled during HDMI input

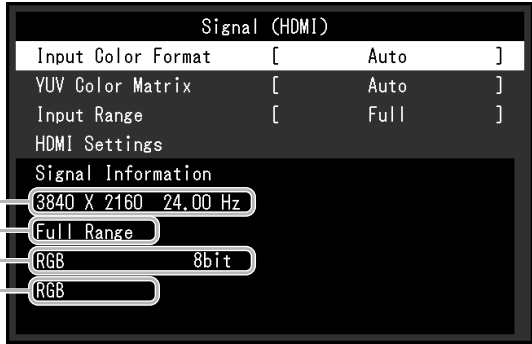
Function		Settings	Description
YUV Color Matrix		Auto BT.601 BT.709 BT.2020	Select the YUV format of the input signal. Use this setting for gradation collapse or other occurrences where the screen is displayed incorrectly because of a problem with the input signal.
Input Range		Auto Full Limited (109% white) Limited	<p>Depending on the external device, the black and white levels in the video signal output to the monitor may be restricted. If the signal is displayed on the monitor in its restricted form, the blacks will be faint, the whites dull, and contrast will be reduced. The brightness range of such signals can be extended to match the actual contrast ratio of the monitor.</p> <ul style="list-style-type: none"> "Auto" The monitor automatically recognizes the brightness range of input signals and displays images appropriately. "Full" The input signal brightness range is not extended. "Limited (109% white)" The brightness range of the input signal is extended from 16 - 254 (10 bits: 64 - 1019) to 0 - 255 (10 bits: 0 - 1023) for display. "Limited" The brightness range of the input signal is extended from 16 - 235 (10 bits: 64 - 940) to 0 - 255 (10 bits: 0 - 1023) for display.
HDMI Settings	Noise Reduction	On Off	<p>The small noises that occur in dark areas of an image are reduced. Use this function to reduce noise and roughness in images.</p> <p>Note</p> <ul style="list-style-type: none"> This can only be set when there is HDMI input. If signals of the following resolutions are input, the function does not work even if set to "On". 1600 x 1200 / 1920 x 1200 / 2048 x 1080 / 2048 x 1152 / 2560 x 1080 / 2560 x 1440 / 2560 x 1600 / 3840 x 2160 For the supported resolutions for HDMI, see "HDMI" (page 10). Using the Noise Reduction function may lead to deterioration of fine images.
Signal Information		-	<p>You can check the information for the input signal. The following information is displayed:</p> <ol style="list-style-type: none"> Resolution / Vertical scan frequency Input range Color format / Color depth Colorimetry  <p>Note</p> <ul style="list-style-type: none"> Some information may not be displayed depending on the input signal.

● Color

When the screen is displayed in User / Adobe®RGB / sRGB, you can adjust the color settings of each color mode according to your preference.



Attention

- The same image may be seen in different colors on multiple monitors due to differences between individual monitors. Make fine color adjustment visually when matching colors on multiple monitors.

Note

- Use the values shown in "cd/m²" and "K" as a guide only.

Function	Settings	Description
Color Mode	User Adobe® RGB sRGB CAL1 CAL2 CAL3 CAL4 CAL5 CAL6 CAL7	Switch to the desired mode according to the monitor application. Note <ul style="list-style-type: none"> • For more information on how to switch modes, see "2-3. Switching the Display Mode (color mode)" (page 17). • CAL2 to CAL7 are disabled in the default settings. Refer to "Mode Skip" (page 31) to enable CAL2 to CAL7.
Brightness	40 cd/m ² to 400 cd/m ²	The screen brightness is adjusted by changing the brightness of the backlight (light source from the LCD back panel). Note <ul style="list-style-type: none"> • If a value that cannot be set is selected, the value will appear in magenta. In such a case, change the value.
Temperature	Native 4000 K to 10000 K D50 D65 User	The color temperature can be adjusted. The color temperature is used to express the chromaticity of "White". The value is expressed in degrees "K" (Kelvin). The screen becomes reddish at a low color temperature, and bluish at a high color temperature, like the temperature of a flame. Specify a color temperature in units of 100 K, or select a standard name. Note <ul style="list-style-type: none"> • When you select "Native", the original color of the LCD panel (Gain: 100 % for each RGB) is displayed. • "Gain" allows you to perform more advanced adjustment. When gain is changed, the color temperature is changed to "User". • The gain preset values are set for each color temperature setting value.

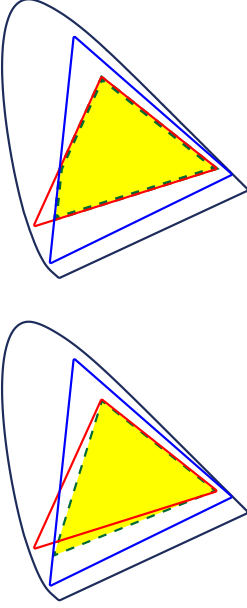

Function	Settings	Description
Gamma	1.6 to 2.7 sRGB	<p>Adjust the gamma.</p> <p>The brightness of the monitor varies depending on the input signal, however, the variation rate is not simply proportional to the input signal. The control performed to keep the balance between the input signal and the brightness of the monitor is called "Gamma correction".</p> <p>Set the gamma, or select a standard name.</p>
Color Gamut	Native Adobe® RGB sRGB	<p>Set the color reproduction area (color gamut).</p> <p>"Color Gamut" is the range of colors that can be represented. Multiple standards are defined.</p> <p>Note</p> <ul style="list-style-type: none"> • When you select "Native", the screen is displayed in the original color gamut of the LCD panel. • The method of displaying colors outside the monitor's displayable range within the defined color gamut can be set. For more information, see "Gamut Clipping" (page 28).

Function		Settings	Description
Advanced Settings	Hue	-100 to 100	<p>The hue can be adjusted.</p> <p>Note</p> <ul style="list-style-type: none"> Using this function may make some color gradations unavailable for display.
	Saturation	-100 to 100	<p>The saturation can be adjusted.</p> <p>Note</p> <ul style="list-style-type: none"> Using this function may make some color gradations unavailable for display. The minimum value (-100) changes the screen to monochrome.
	Gamut Clipping	On Off	<p>The method of displaying colors outside the monitor's displayable range within the color gamut specified in accordance with "Color Gamut" (page 27) can be set.</p> <ul style="list-style-type: none"> "On" <ul style="list-style-type: none"> The range of colors that are displayable on the monitor will be accurately displayed in accordance with the standard. Colors outside the displayable range will be saturated. "Off" <ul style="list-style-type: none"> Displays colors with priority on the color gradation rather than the color accuracy. The vertices of the color gamut defined in the standard move to a range that can be displayed by the monitor. This allows the closest colors displayable by the monitor to be displayed. <div style="text-align: right;">  </div> <hr/> <p> — Color gamut displayable by the monitor — Color gamut defined by standard - - - Color gamut displayed on screen </p> <p>Note</p> <ul style="list-style-type: none"> The diagrams shown above are conceptual diagrams, and they do not display the actual color gamut of the monitor. This setting will be disabled if "Native" is selected at "Color Gamut" (page 27).
	Gain	0 to 2000	<p>The brightness of each color component red, green, and blue is called Gain. The chromaticity of "white" can be changed by adjusting the gain.</p> <p>Note</p> <ul style="list-style-type: none"> Using this function may make some color gradations unavailable for display. The gain value changes according to the color temperature. When gain is changed, the color temperature is changed to "User".
6 Colors	-100 to 100	<p>The hue, saturation and lightness (brightness) can each be adjusted for the colors Magenta, Red, Yellow, Green, Cyan, and Blue.</p>	
Reset	OK Cancel	<p>Resets any color adjustment values for the currently selected color mode back to the default settings.</p>	

● Screen

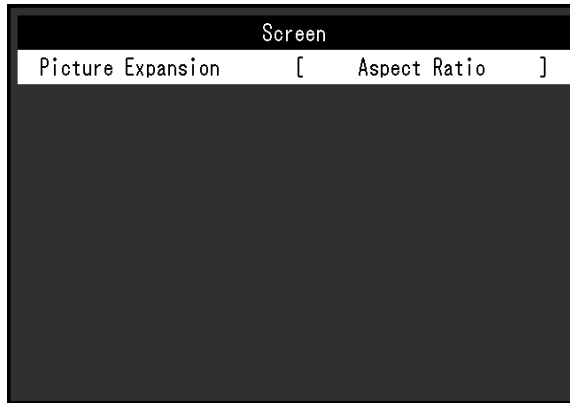
Set the screen display size.

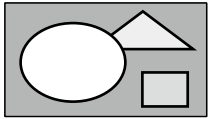
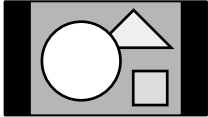

Function	Settings	Description
Picture Expansion	Auto Full Screen Aspect Ratio Dot by Dot	<p>The screen size of the monitor display can be changed.</p> <ul style="list-style-type: none"> "Auto" The monitor automatically changes the screen size according to the resolution information and aspect ratio information from the input signal (only for HDMI input). "Full Screen" Displays an image in full screen. Images are distorted in some cases because the magnification ratio is not necessarily fixed vertically and horizontally. "Aspect Ratio" Displays an image in full screen. However, since aspect ratios are maintained, part of an image may not be visible in horizontal or vertical direction. "Dot by Dot" Displays the image at the set resolution or at the size specified by the input signal. <p>Note</p> <ul style="list-style-type: none"> Example settings <ul style="list-style-type: none"> - Full Screen  - Aspect Ratio  - Dot by Dot (Input Signal) 

● Preferences

The monitor's settings can be configured to suit the usage environment or personal preference.

Preferences		
Menu Rotation	[0°]
Power Save	[On]
Indicator	[4]
Beep	[On]
Input Skip		
Mode Skip		
Custom Key		
USB Selection		
Monitor Reset		

Function	Settings	Description
Menu Rotation	0° 90°	<p>This function allows you to change the orientation of the Setting menu to align with the installation orientation.</p> <p>Note</p> <ul style="list-style-type: none"> • When using the monitor screen in a portrait position, the graphics board supporting portrait display is required. When placing the monitor in a portrait position, settings of your graphics board need to be changed. Refer to the User's Manual of the graphics board for details. • When using the monitor in a portrait position, rotate the monitor after pulling up the screen to the uppermost position of the stand and setting the screen tilted upward. 
Power Save	On Off	<p>This function allows you to set the monitor to the power saving mode, depending on the state of an external device connected to it.</p> <p>The monitor changes to power saving mode about 15 seconds after signal input ceases to be detected. When the monitor has shifted to power saving mode, images are not displayed on the screen.</p> <ul style="list-style-type: none"> • Exiting power saving mode <ul style="list-style-type: none"> - If the monitor receives input, it automatically exits power saving mode and returns to the normal display mode. <p>Note</p> <ul style="list-style-type: none"> • At the time of shifting to power saving mode, a message that indicates the transition is displayed 5 seconds in advance. • When you are not using the monitor, turn off the main power switch to cut down on power consumption. • When the monitor is in power saving mode, devices connected to the USB downstream port will still work. Therefore, power consumption of the monitor varies depending on the connected devices, even in the power saving mode.

Function		Settings	Description						
Indicator		Off 1 to 7	The brightness of the power switch and the operation switches when the screen is displayed can be set. (Default setting: 4)						
Beep		On Off	You can set the beep that sounds each time a switch is operated.						
Input Skip		Skip -	This function allows skipping of input signals that will not be used when the input signals are switched. Note • Not all input signals can be set to "Skip".						
Mode Skip		Skip -	This function allows skipping of modes that will not be used when selecting modes. Please use this function if display modes are limited, or if you want to prevent randomly changing the display status. Note • Not all modes can be set to "Skip".						
Custom Key	[F1] [F2]	Off Brightness Prev. Color Mode Information	You can set the function that is assigned to the [F1] or [F2] switch. Note • By default, the [F1] switch is set to the "Brightness" function and the [F2] switch is set to "Prev. Color Mode". • Regarding the custom keys, see " Chapter 3 Custom Key Settings " (page 19).						
USB Selection	HDMI DisplayPort USB-C	USB-1 (USB-C) USB-2	When two PCs are connected to one monitor, you can link the input signal with the USB upstream port. After linking, the USB ports will automatically switch when the input signals switch. When you calibrate one monitor from two PCs, it is not necessary to switch USB cables. It is also possible to connect USB devices such as a mouse or keyboard to the monitor and use them from two PCs. The default settings may differ depending on the input signal. <table border="1" data-bbox="783 1267 1361 1386"> <thead> <tr> <th>Input signal</th> <th>Default setting</th> </tr> </thead> <tbody> <tr> <td>HDMI, DisplayPort</td> <td>USB-2</td> </tr> <tr> <td>USB Type-C</td> <td>USB-1 (USB-C)</td> </tr> </tbody> </table> Note • When you want to change settings and there is a storage device such as USB memory connected to the monitor, change settings only after you have removed the storage device. In failing to do so, data may be lost or damaged. • You cannot change the keyboard layout. • The USB downstream port works with the PC that is currently being displayed.	Input signal	Default setting	HDMI, DisplayPort	USB-2	USB Type-C	USB-1 (USB-C)
Input signal	Default setting								
HDMI, DisplayPort	USB-2								
USB Type-C	USB-1 (USB-C)								
Monitor Reset		OK Cancel	Restore all settings to their default values except for the following settings. • Settings in the "Administrator Settings" menu • The "USB Selection" item in the "Preferences" menu						

● Languages

The display language for menus and messages can be selected.

Settings

English, German, French, Spanish, Italian, Swedish, Japanese, Simplified Chinese, Traditional Chinese



● Information

You can check the monitor information (model name, serial number (S/N), firmware version, usage time) and the input signal information.

Example:

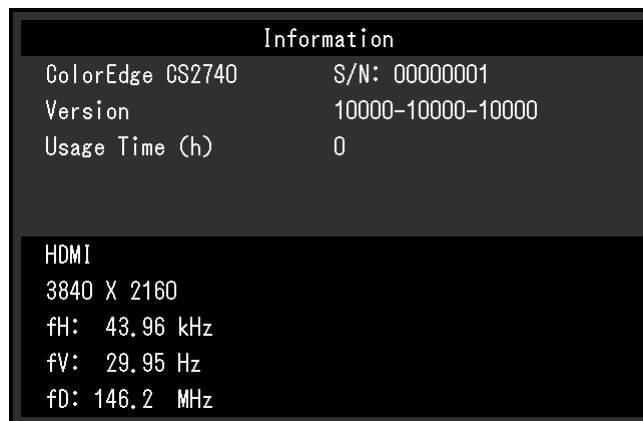

Chapter 5 Administrator Settings

This chapter describes how to configure monitor operation using the "Administrator Settings" menu.

5-1. Basic Operation of the "Administrator Settings" Menu

1. Menu display

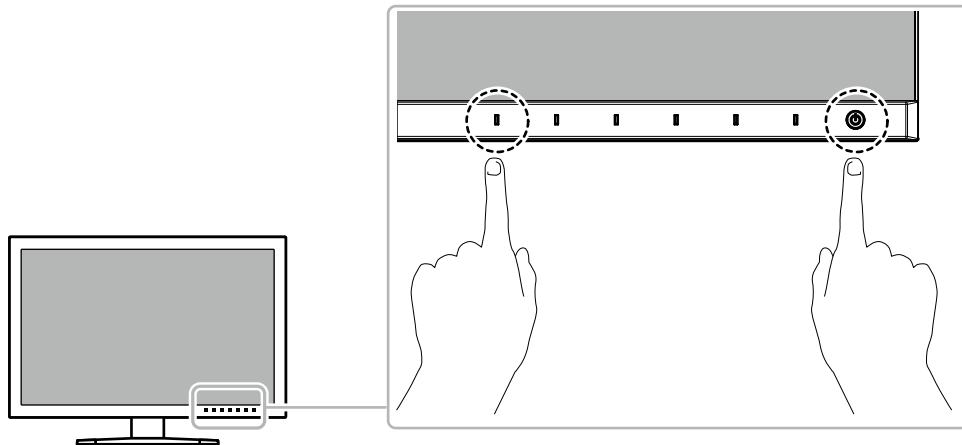

1. Touch  to turn off the monitor.
2. While touching the leftmost switch, touch  for more than 2 seconds to turn on the monitor.



The "Administrator Settings" menu appears.

Administrator Settings		
Auto Input Detection	[Off]
On-Screen Logo	[On]
Information Display	[Off]
Key Lock	[Off]
Compatibility Mode	[On]
DUE Priority	[Uniformity]
Signal Format		
Apply		

2. Setting

1. Choose an item to set with  , and then select .
- The Adjustment/Setting menu appears.

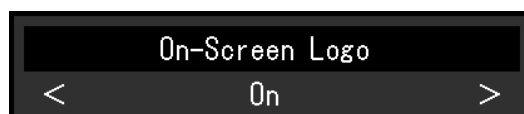

2. Set the item with  , and then select .
- The "Administrator Settings" menu appears.



3. Applying and exiting

1. Select "Apply", and then select .

The settings are confirmed and the "Administrator Settings" menu quits.

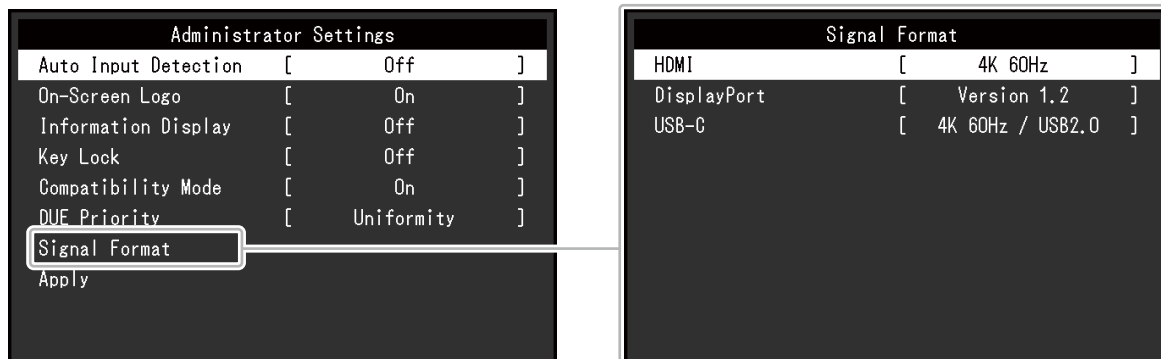
5-2. "Administrator Settings" Menu Functions







Function	Settings	Description
Auto Input Detection	Off On	When this function is set to "On", the monitor automatically recognizes the connector through which signals are input, so that the screen can be displayed. If the input signal for the selected connector is lost, the monitor automatically switches to a different signal. When set to "Off", the monitor displays the signal from the selected connector regardless of whether a signal is input or not. In this case, select the input signal to display using the operation switch () on the front of the monitor.
On-Screen Logo	Off On	When this function is set to "Off", the EIZO logo that is displayed when the monitor is turned on does not appear.
Information Display	Off On	When this function is set to "On", detailed information about the input signal is displayed when the signal or color mode is switched. The following information is displayed: <ul style="list-style-type: none"> • Resolution • Vertical scan frequency • Input range • Color format • Color depth When set to "Off", detailed information is not displayed when the signal or color mode is switched.
Key Lock	Off Menu All	In order to prevent changes to settings, the operation switches on the front of the monitor can be locked. <ul style="list-style-type: none"> • "Off" (Default setting) Enable all switches. • "Menu" Lock the  switch. • "All" Lock all switches except the power switch.
Compatibility Mode	Off On	To avoid the following effects, set this function to "On". <ul style="list-style-type: none"> • When you switch the monitor's power back on or return from power saving mode, windows or icons may have shifted position. • The PC's power save function does not operate correctly.

Function		Settings	Description
DUE Priority		Uniformity Brightness	<p>This product is equipped with a Digital Uniformity Equalizer (DUE) function that reduces display unevenness. This DUE setting can be changed.</p> <ul style="list-style-type: none"> • "Uniformity" Prioritizes reduction of display unevenness. • "Brightness" Prioritizes high brightness and high contrast. <p>Note</p> <ul style="list-style-type: none"> • When changing the DUE setting, the monitor whose display is adjusted must be re-calibrated. Perform the calibration again.
Signal Format	HDMI	4K 30Hz 4K 60Hz 4K 60Hz / YUV	<p>You can switch the signal type that the monitor can display. Try changing this setting if the input signal is not displayed, or if the displayed image does not appear correctly.</p> <p>Note</p> <ul style="list-style-type: none"> • When "USB-C" is set, the types of signals that can be displayed by the monitor and the USB settings can be switched.
	DisplayPort	Version 1.1 Version 1.2 Version 1.2 / YUV	
	USB-C	4K 30Hz / USB3.1 4K 60Hz / USB2.0 4K 60Hz / USB2.0 / YUV	

Chapter 6 Troubleshooting

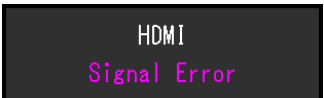
6-1. No Picture

Problem	Possible cause and remedy
<p>1. No picture</p> <ul style="list-style-type: none"> Power indicator does not light up. <hr/> <ul style="list-style-type: none"> Power indicator is lighting white. <hr/> <ul style="list-style-type: none"> Power indicator is lighting orange. <hr/> <ul style="list-style-type: none"> Power indicator is flashing orange and white. 	<ul style="list-style-type: none"> Check whether the power cord is connected properly. Turn on the main power switch on the rear side of the monitor. Touch . Turn off the main power switch on the rear side of the monitor, and then turn it on again a few minutes later. <hr/> <ul style="list-style-type: none"> Increase "Brightness" and/or "Gain" in the Setting menu (see "Color" (page 26)). <hr/> <ul style="list-style-type: none"> Switch the input signal. Move the mouse or press any key on the keyboard. Check whether the external device is turned on. Turn off the main power switch on the rear side of the monitor, and then turn it on again. <hr/> <ul style="list-style-type: none"> This problem may occur when an external device is connected via the DisplayPort connector or the USB Type-C connector. Connect via the signal cable specified by EIZO, turn off the monitor, and then turn it on again.
<p>2. The message below appears.</p> <ul style="list-style-type: none"> This message appears when no signal is input. <p>Example: </p> <hr/> <ul style="list-style-type: none"> The message shows that the input signal is out of the frequency specification range. <p>Example: </p> <hr/> <ul style="list-style-type: none"> This message appears when an external device connected to the USB Type-C connector does not support video signal output. <p>Example: </p>	<p>This message appears when the signal is not input correctly even though the monitor is functioning properly.</p> <hr/> <ul style="list-style-type: none"> The message shown left may appear, because some external devices do not output the signal immediately after power-on. Check whether the external device is turned on. Check whether the signal cable is connected properly. Switch the input signal. Turn off the main power switch on the rear side of the monitor, and then turn it on again. Try changing "Signal Format" in the "Administrator Settings" menu (see "Signal Format" (page 35)). <hr/> <ul style="list-style-type: none"> Check whether the external device is configured to meet the resolution and vertical scan frequency requirements of the monitor (see "1-3. Supported Resolutions" (page 9)). Reboot the external device. Change to the appropriate setting using the graphics board's utility. Refer to the User's Manual of the graphics board for details. <hr/> <ul style="list-style-type: none"> Check whether the signal cable specified by EIZO is connected. Check whether the USB Type-C port of the connected device supports video signal output. For details, contact the manufacturer of the device. Connect a DisplayPort cable or an HDMI cable.

6-2. Imaging Problems

Problem	Possible cause and remedy
1. The screen is too bright or too dark.	<ul style="list-style-type: none"> Use "Brightness" in the Setting menu to adjust it (see "Color" (page 26)). The LCD monitor backlight has a limited life span. If the screen becomes dark or begins to flicker, contact your local EIZO representative.
2. Afterimages appear	<ul style="list-style-type: none"> Afterimages are particular to LCD monitors. Avoid displaying the same image for a long time. Use the screen saver or power saving function to avoid displaying the same image for extended periods of time.
3. Green/red/blue/white dots remain on the screen / Defective dots remain on the screen	<ul style="list-style-type: none"> This is due to LCD panel characteristics and not a malfunction.
4. Interference patterns or pressure marks remain on the screen.	<ul style="list-style-type: none"> Display a white or black image over the entire screen. The symptom may disappear.
5. Noise appears on the screen.	<ul style="list-style-type: none"> When inputting HDCP system signals, normal images may not be displayed immediately.
6. When you switch the power back on or return from power saving mode, windows or icons may have shifted position.	<ul style="list-style-type: none"> In the "Administrator Settings" menu, set "Compatibility Mode" to "On" (see "Compatibility Mode" (page 34)).
7. The screen colors look strange.	<ul style="list-style-type: none"> Try changing "Input Color Format" in the Setting menu (see "Input Color Format" (page 24)). For HDMI signal input, try changing "Signal Format" in the "Administrator Settings" menu (see "Signal Format" (page 35)).
8. The image does not display on the entire screen.	<ul style="list-style-type: none"> Try changing "Picture Expansion" in the Setting menu (see "Picture Expansion" (page 29)). Try changing "Signal Format" in the "Administrator Settings" menu (see "Signal Format" (page 35)). Is the resolution set to the recommended resolution (3840 x 2160)? For details on the settings, refer to the User's Manual of the graphics board.

6-3. Other Problems

Problem	Possible cause and remedy
1. The Setting menu/Mode menu cannot be displayed	<ul style="list-style-type: none"> • Check whether the operation switch lock function works (see “Key Lock” (page 34)). • Control switches are locked when the main window of ColorNavigator 7 is displayed. Exit the software.
2. The monitor connected with the USB cable is not detected. / The peripheral USB device connected to the monitor does not work.	<ul style="list-style-type: none"> • Check whether the USB cable is connected correctly (see “8-3. Making Use of the USB Hub Function” (page 44)). • Check whether the correct USB upstream port is selected (see “USB Selection” (page 31)). • Try changing to a different USB port on the external device. • Try changing to a different USB port on the monitor. • Reboot the external device. • If the peripheral devices work correctly when the external device and peripheral devices are connected directly, contact your local EIZO representative. • Check whether the external device and OS are USB compliant. (For USB compliance of the respective devices, consult their manufacturers.) • Depending on the USB 3.1 host controller that you are using, connected USB devices may not be recognized correctly. Update to the latest USB 3.1 driver provided by each manufacturer, or connect the monitor to the USB 2.0 port. • Check the external device's BIOS setting for USB when using Windows. (Refer to the User's Manual of the external device for details.)
3. Audio is not output.	<ul style="list-style-type: none"> • This product is not equipped with a speaker.

Chapter 7 Attaching/Detaching the Stand

7-1. Removing the Stand

The stand section of this product can be removed.

Attention

- Do not move the removed stand up and down. Doing so may result in injury or equipment damage.
- Since the monitor and stand are heavy, dropping them may result in injury or equipment damage.

1. To prevent damaging the LCD panel surface, lay the monitor with its LCD panel surface facing down on a soft cloth spread on a stable surface.

2. Remove the stand.

Press and hold the lock button (1), firmly grip the stand support, and then slide the stand in the direction of the base of the stand (2).

When the tab that holds the stand in place loosens, remove the stand (3).

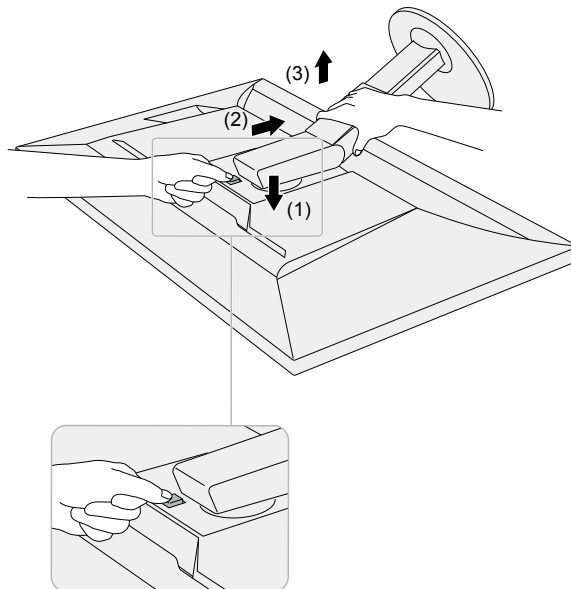

7-2. Attaching the Optional Arm

An optional arm (or an optional stand) can be attached by removing the stand section. Please refer to our web site for the corresponding optional arm (or optional stand). www.eizoglobal.com

Attention

- When attaching an arm or stand, follow the instructions of their User's Manual.
- When using another manufacturer's arm or stand, confirm the following in advance and select one conforming to the VESA standard. Use the VESA mounting screws supplied with this product when attaching the arm or stand.
 - Clearance between screw holes: 100 mm x 100 mm
 - External dimensions of the VESA mount section of the arm or stand: 122 mm x 122 mm or less
 - Plate thickness: 2.6 mm
 - Must be strong enough to support weight of the monitor unit (excluding the stand) and attachments such as cables.
- When using an arm or stand, attach it to meet the following tilt angles of the monitor.
 - Up 45°, down 45°
- Connect the cables after attaching an arm or stand.
- Since the monitor and arm or stand are heavy, dropping them may result in injury or equipment damage.
- When installing the monitor in portrait mode, turn the monitor screen 90° in clockwise direction.

1. Attach the arm or stand to the monitor.

Use the VESA mounting screws supplied with this product when attaching the arm or stand.

7-3. Attaching the Original Stand

1. To prevent damaging the LCD panel surface, lay the monitor with its LCD panel surface facing down on a soft cloth spread on a stable surface.

2. Remove the fixing screws on the optional arm (or optional stand), and detach the optional arm (or optional stand).

3. Attach the original stand.

Insert the four tabs on the stand into the square holes on the back panel (1) and slide the stand towards the upper portion of the monitor until it makes a clicking sound (2).

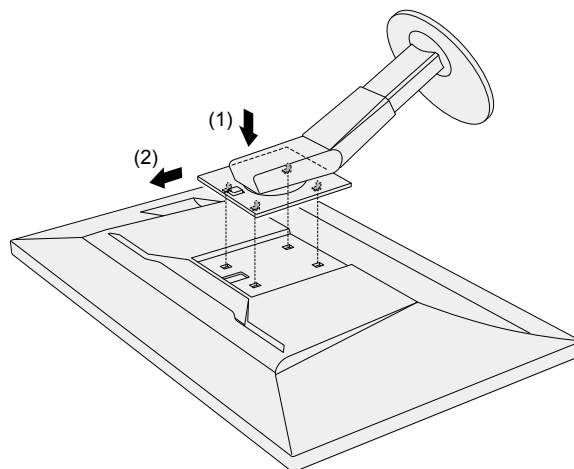

Chapter 8 Reference

8-1. Attaching/Detaching the Cable Holder

A cable holder is supplied with this product. Use the cable holder to organize the cables connected to the monitor.

Attachment procedure

1. Pass the cables through the cable holder.
2. Close the cable holder.

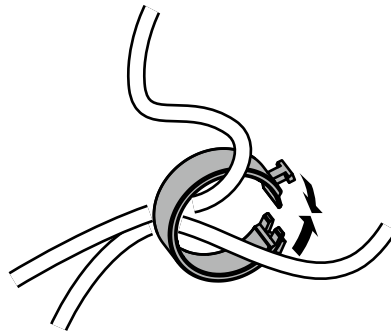

3. In this state, insert the cable holder into the stand.

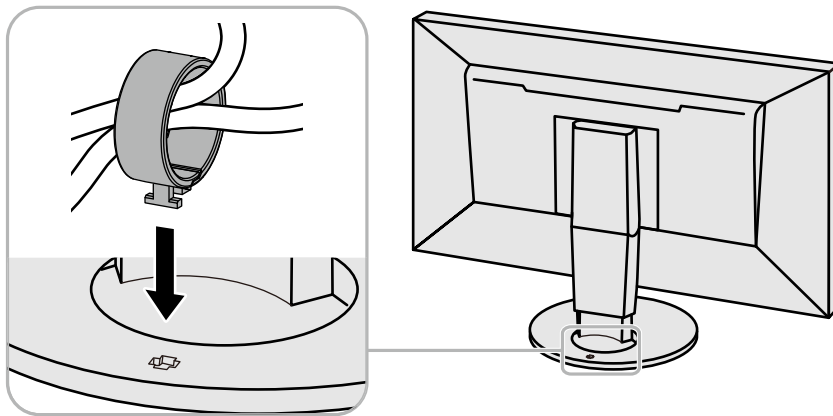

Note

- The cable holder can be inserted either perpendicular or parallel to the stand. Change the orientation of the cable holder in line with the direction of the cables.

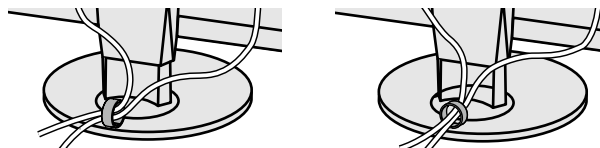

Detachment procedure

- 1.** Close the cable holder.
- 2.** In this state, pull the cable holder from the stand.

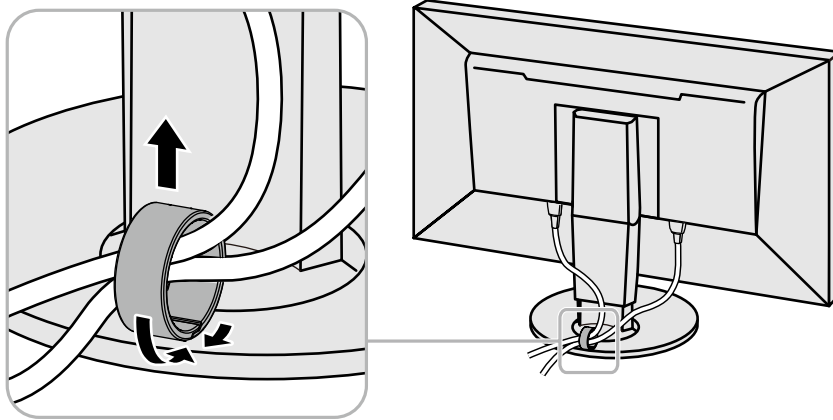

8-2. Connecting Multiple External Devices

The product allows you to connect multiple external devices and switch between them for display.

Connection examples

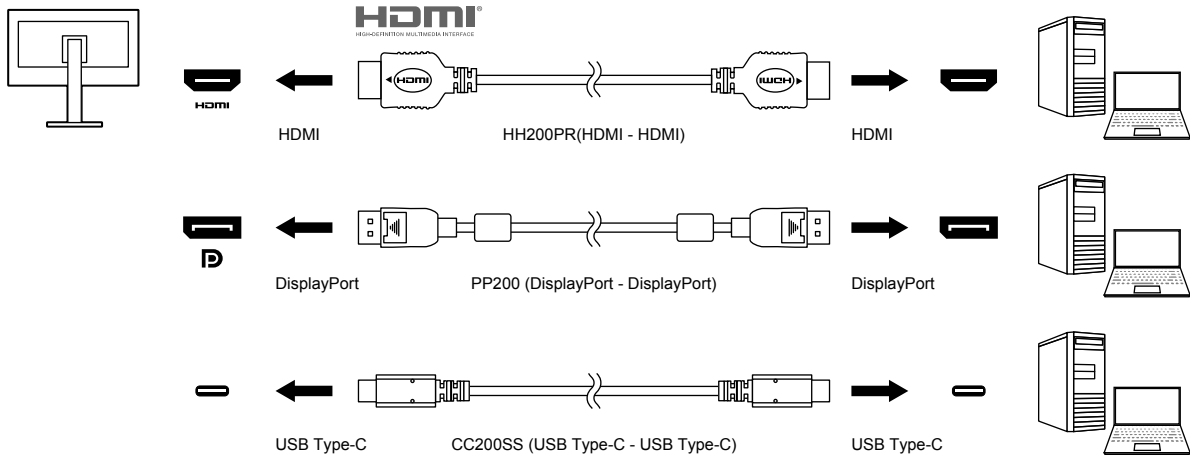

Note

- The input signal changes each time the operation switch () on the front of the monitor is touched. For more information, see ["2-2. Switching Input Signals" \(page 17\)](#).
- The connector through which signals are input is recognized automatically, and images are displayed on the screen accordingly. For more information, see ["Auto Input Detection" \(page 34\)](#).

8-3. Making Use of the USB Hub Function

This monitor is equipped with a USB hub. It works as a USB hub when connected to a USB-compatible external device, allowing the connection of peripheral USB devices.

The USB hub function supports both USB cables (UU200SS) and USB Type-C cables (CC200SS).

● Connection Procedure

1. Connect the USB cable between the USB downstream port of the external device and the USB upstream port (USB Type-B connector or USB Type-C connector) of the monitor.

When connecting to the USB Type-B connector, use a USB cable.

When connecting to the USB Type-C connector, use a USB Type-C cable.

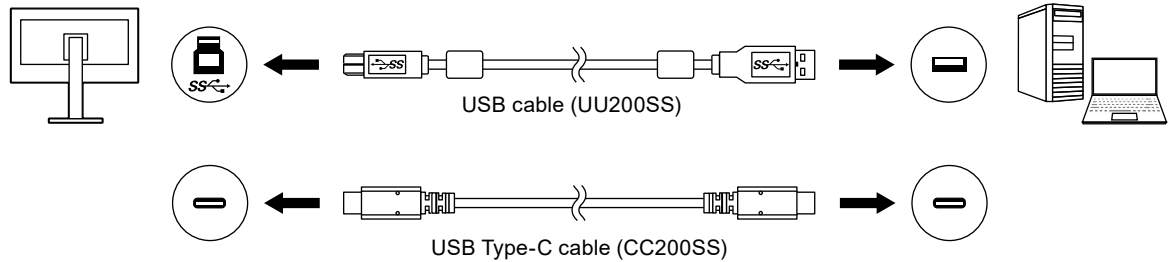

For the locations of the monitor's USB Type-B connector and USB Type-C connector, see "[Rear](#)" ([page 8](#)).

Note

- The enabled USB upstream port (USB Type-B connector or USB Type-C connector) varies depending on the input signal. If the connected USB upstream port is disabled, see "[USB Selection](#)" ([page 31](#)) and change the settings.

2. Connect the peripheral USB device to the USB downstream port of the monitor.

Attention

- This monitor may not work depending on the used external device, OS or peripheral devices. For USB compatibility of peripheral devices, contact their manufactures.
- The monitor's USB Type-C connector cannot function as a USB downstream port.
- When the monitor is in power saving mode, devices connected to the USB downstream port will still work. Therefore, power consumption of the monitor varies depending on the connected devices, even in the power saving mode.
- When the main power switch of the monitor is off, a device connected to the USB downstream port will not operate.

Note

- This product supports USB 3.1 Gen 1. High-speed data communication is possible by connecting the peripheral device and the USB Type-A connector on the side of the rear of the monitor (blue connector) with a USB cable that supports USB 3.1 Gen 1.
- If the peripheral device supports USB 2.0, connect to the USB Type-A connector on the bottom of the rear side of the monitor (black connector) to use USB 2.0.

8-4. Specifications

LCD Panel	Type		IPS (Anti-Glare)
	Backlight		Wide color gamut LED
	Size		68.4 cm (26.9 inch)
	Resolution		3840 dots x 2160 lines
	Display Size (H x V)		596.2 mm x 335.3 mm
	Pixel Pitch		0.155 mm x 0.155 mm
	Pixel Density		164 ppi
	Display Colors		Approx. 1073.74 million colors (10 bit colors)
	Viewing Angle (H x V, typical)		178° / 178°
	Contrast Ratio (typical)		1000:1 (When "DUE priority" setting is "Brightness")
	Response Time (typical)		Black → White → Black: 16 ms Gray-to-gray: 10 ms
	Color Gamut Display (typical)		NTSC ratio 103 % Adobe® RGB coverage: 99 %
Video Signals	Input Terminals		USB Type-C (DisplayPort Alt Mode, HDCP 1.3 compatible) x 1 DisplayPort (HDCP 1.3 compatible) x 1 HDMI (HDCP 1.4, HDCP 2.2, Deep Color compatible) *1 x 1 *1 Not compatible with HDMI CEC function (mutual control function).
	Horizontal scan frequency		USB Type-C (DisplayPort Alt Mode): 25 kHz to 137 kHz DisplayPort: 25 kHz to 137 kHz HDMI: 15 kHz to 135 kHz
	Vertical scan frequency		USB Type-C (DisplayPort Alt Mode): 23 Hz to 61 Hz (For 720 x 400: 69 Hz to 71 Hz) DisplayPort: 23 Hz to 61 Hz (For 720 x 400: 69 Hz to 71 Hz) HDMI: 23 Hz to 61 Hz (For 720 x 400: 69 Hz to 71 Hz)
	Frame Synchronization mode		23.75 Hz to 30.5 Hz, 47.5 Hz to 61.0 Hz
	Dot clock (Max.)		USB Type-C (DisplayPort Alt Mode): 598.3 MHz DisplayPort: 598.3 MHz HDMI: 600 MHz
USB	Port	Upstream	USB Type-C (USB 3.1 Gen 1) x 1 USB Type-B (USB 3.1 Gen 1) x 1
		Downstream	USB Type-A (USB 3.1 Gen 1) x 2 USB Type-A (USB 2.0) x 2
	Standard		USB Specification Revision 3.1 Gen 1 USB Specification Revision 2.0
	Communication Speed		5 Gbps (super) ^{*2} , 480 Mbps (high), 12 Mbps (full), 1.5 Mbps (low) *2 The downstream port (USB 2.0) does not support 5 Gbps.
	Supply Current	Upstream	USB Type-C (USB 3.1 Gen 1): Maximum 60 W
		Downstream	USB Type-A (USB 3.1 Gen 1): Maximum 900 mA per port USB Type-A (USB 2.0): Maximum 500 mA per port
Power	Input		100-240 VAC ±10 %, 50/60 Hz 1.70 A - 0.75 A
	Maximum Power Consumption		168 W or less
	Power Save Mode		1.0 W or less (Only for DisplayPort input, when "Compatibility Mode" is set to "Off" and no USB device is connected)
	Standby Mode		1.0 W or less (When there is no input signal, "Compatibility Mode" is set to "Off", and no USB device is connected)

Physical Specifications	Outside Dimensions	Minimum Height	638 mm x 404.1 mm x 265 mm (W x H x D) (Tilt: 0°)
		Maximum Height	638 mm x 570 mm x 269.1 mm (W x H x D) (Tilt: 35°)
	Outside Dimensions (Without Stand)		638 mm x 378.2 mm x 75 mm (W x H x D)
	Net Weight		Approx. 10.3 kg
	Net Weight (Without Stand)		Approx. 6.7 kg
	Height adjustment		155 mm (at tilt of 0°) / 145 mm (at tilt of 35°)
	Tilt		Up 35°, down 5°
	Swivel		344°
	Vertical rotation		90° clockwise
Operating Environment Requirements	Temperature		0°C to 35°C
	Humidity		20 % to 80 % R.H. (no condensation)
	Air Pressure		540 hPa to 1060 hPa
Transportation/ Storage Environment Requirements	Temperature		-20°C to 60°C
	Humidity		10 % to 90 % R.H. (no condensation)
	Air Pressure		200 hPa to 1060 hPa

● Accessories

For the latest information about the accessories, refer to our website (www.eizoglobal.com).

Appendix

Trademark

The terms HDMI and HDMI High-Definition Multimedia Interface, and the HDMI Logo are trademarks or registered trademarks of HDMI Licensing, LLC in the United States and other countries.

The DisplayPort Compliance Logo and VESA are registered trademarks of the Video Electronics Standards Association.

The SuperSpeed USB Trident Logo is a registered trademark of USB Implementers Forum, Inc.



The USB Power Delivery Trident Logos are trademarks of USB Implementers Forum, Inc.



DICOM is the registered trademark of the National Electrical Manufacturers Association for its standards publications relating to digital communications of medical information.

Kensington and Microsaver are registered trademarks of ACCO Brands Corporation.

Thunderbolt is a trademark of Intel Corporation in the United States and/or other countries.

Microsoft and Windows are registered trademarks of Microsoft Corporation in the United States and other countries.

Adobe is a registered trademark of Adobe Systems Incorporated in the United States and other countries.

Apple, macOS, Mac OS, OS X, Macintosh and ColorSync are registered trademarks of Apple Inc.

ENERGY STAR is a registered trademark of the United States Environmental Protection Agency in the United States and other countries.

EIZO, the EIZO Logo, ColorEdge, CuratOR, DuraVision, FlexScan, FORIS, RadiCS, RadiForce, RadiNET, Raptor and ScreenManager are registered trademarks of EIZO Corporation in Japan and other countries.

ColorEdge Tablet Controller, ColorNavigator, EcoView NET, EIZO EasyPIX, EIZO Monitor Configurator, EIZO ScreenSlicer, G-Ignition, i•Sound, Quick Color Match, RadiLight, Re/Vue, SafeGuard, Screen Administrator, Screen InStyle, ScreenCleaner and UniColor Pro are trademarks of EIZO Corporation.

All other company names, product names, and logos are trademarks or registered trademarks of their respective companies.

License

The bitmap font used for this product is designed by Ricoh Industrial Solutions Inc.

Information for Radio Interference

For U.S.A., Canada Only

FCC Supplier's Declaration of Conformity

We, the Responsible Party

EIZO Inc.

5710 Warland Drive, Cypress, CA 90630

Phone: (562) 431-5011

declare that the product

Trade name: EIZO

Model: ColorEdge CS2740

is in conformity with Part 15 of the FCC Rules. Operation of this product is subject to the following two conditions: (1) this device may not cause harmful interference, and (2) this device must accept any interference received, including interference that may cause undesired operation.

This equipment has been tested and found to comply with the limits for a Class B digital device, pursuant to Part 15 of the FCC Rules. These limits are designed to provide reasonable protection against harmful interference in a residential installation. This equipment generates, uses, and can radiate radio frequency energy and, if not installed and used in accordance with the instructions, may cause harmful interference to radio communications. However, there is no guarantee that interference will not occur in a particular installation. If this equipment does cause harmful interference to radio or television reception, which can be determined by turning the equipment off and on, the user is encouraged to try to correct the interference by one or more of the following measures.

- * Reorient or relocate the receiving antenna.
- * Increase the separation between the equipment and receiver.
- * Connect the equipment into an outlet on a circuit different from that to which the receiver is connected.
- * Consult the dealer or an experienced radio/TV technician for help.

Changes or modifications not expressly approved by the party responsible for compliance could void the user's authority to operate the equipment.

Note

Use the attached specified cable below or EIZO signal cable with this monitor so as to keep interference within the limits of a Class B digital device.

- AC Cord
- Shielded Signal Cable (enclosed)

Canadian Notice

This Class B information technology equipment complies with Canadian ICES-003.

Cet équipement informatique de classe B est conforme à la norme NMB-003 du Canada.

