

DesignMax DM8C-SUB

in-ceiling subwoofer

Product Overview

DesignMax loudspeakers bring outstanding audio and aesthetics to any commercial space. The 150-watt DesignMax DM8C-SUB subwoofer features an 8-inch woofer and delivers a 38 Hz - 155 Hz frequency range. The DM8C-SUB is ceiling-mounted, installed easily via QuickHold mounting arms. And with both black and white versions available, the DM8C-SUB is easy to integrate with any décor.



Key Features

Deliver instantly impressive sound with custom Bose drivers — no DSP or EQ required. For even better sound, use select Bose DSPs and amplifiers to enable Bose loudspeaker EQ

Blend into any room design with elegant form factors, minimum-bezel grilles available in black or white, and removable logos

Reduce installation time with the patented QuickHold mounting system, which also reduces strain, hassle, and the chance of product damage

Install easily — includes Euroblock connectors; plenum-rated backcan, tile-bridge, and front-access audio wiring that makes installation and troubleshooting easier

Deliver high SPL for demanding applications

Technical Specifications

SINGLE LOUDSPEAKER PERFORMANCE		
Frequency Response (-3 dB) ⁽¹⁾	45 - 117 Hz	
Frequency Range (-10 dB)	38 - 155 Hz	
Nominal Coverage Angle ⁽²⁾	Omnidirectional below 200 Hz	
Nominal Coverage Angle (1 - 10 kHz)	Omnidirectional below 200 Hz	
	Bose extended-lifecycle test ⁽⁵⁾	AES component test ⁽⁶⁾
Power Handling, long-term continuous	150 W	180 W
Power Handling, peak	600 W	720 W
Sensitivity (SPL/ 1W @ 1 m) ⁽³⁾	89 dB	89 dB
Calculated Maximum SPL @ 1 m ⁽⁴⁾	111 dB	112 dB
Calculated Maximum SPL @ 1 m, peak	117 dB	118 dB
Recommended High-Pass Protection	40 Hz with recommended 18 dB / octave filter	
Recommended Crossover	80 - 200 Hz (via active crossover in DSP)	
Transformer taps	70V: 20, 40, 80, 150 W, bypass 100V: 40, 80, 150 W, bypass	
TRANSDUCERS		
Low Frequency	1 x 8-inch woofer (203 mm)	
Nominal Impedance	8 ohms (transformer bypass)	

DesignMax DM8C-SUB

in-ceiling subwoofer

PHYSICAL	
Enclosure Material	Engineered-plastics front baffle with integrated steel formed back can
Grille	Magnetically attached perforated steel, powder-coated finish, paintable, with safety-tether
Logo	Rotatable, removable
Color	Black: Ral 9005, White: Bose Arctic White, Paintable
Environmental / Ingress-Protection	Indoor only
Safety Agency	UL-1480A, S5591/ UL Listed, in compliance with UL2043 for plenum-space installation, NFPA70 & NFPA90-A, in accordance with IEC60268-5, ROHS, CE compliant
Operating Temperature Range	0 to 50 °C (32 °F to 122 °F)
Connectors	Euroblock 6-pin connector with loop-through, front-baffle mounted. Accepts 18 AWG (0.8 mm ²) to 14 AWG (2.5 mm ²) size wire.
Wire / Conduit Entry	Single top wire entry point, allows for 9.5 mm (3/8 in) conduit
Suspension / Mounting	Three (3) QuickHold, spring-loaded mounting arms plus three (3) safety cable locations
Maximum Ceiling Thickness	76 mm (3.0 in)
Product Dimensions (Grille Diameter x Depth)	409 × 255 mm (16.1 × 10.0 in)
Backcan Dimensions (Diameter x Depth)	342 × 241 mm (13.5 × 9.5 in)
Ceiling Cutout	349 mm (13.8 in)
Net Weight, Loudspeaker with grille (single)	9.8 kg (21.6 lb)
Net Weight, Tile Bridge	1.0 kg (2.2 lb)
Shipping Weight	12.9 kg (28.5 lb)
Included Accessories	Adjustable Tile-Bridge, Template
Optional Accessories	Rough-in 6-pack for new construction
PRODUCT CODES	
829380-0110	DESIGNMAX DM8C-SUB SINGLE BLK
829380-0210	DESIGNMAX DM8C-SUB SINGLE WHT

Footnotes

- (1) Frequency response and range measured on-axis in quarter-space (wall/ceiling boundary) environment with recommended EQ
- (2) 1 kHz to 4 kHz average
- (3) Sensitivity measured on-axis in quarter-space (wall/ceiling boundary) environment with recommended EQ
- (4) Maximum SPL calculated from sensitivity and power handling specifications, exclusive of power compression.
- (5) Bose extended-lifecycle test using pink noise filtered to meet IEC268-5, 6-dB crest factor, 500-hour duration.
- (6) AES standard 2-hour duration with IEC system noise

For additional specifications and application information, please visit PRO.BOSE.COM. Specifications subject to change without notice. 10/2019

DesignMax DM8C-SUB

in-ceiling subwoofer

On-Axis Frequency Response (half-space (2) with Bose EQ voicing)

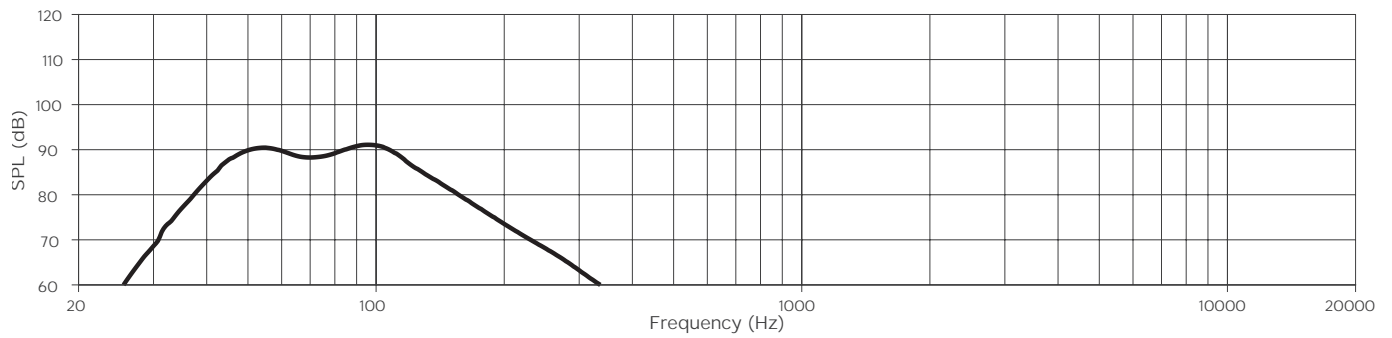

Impedance

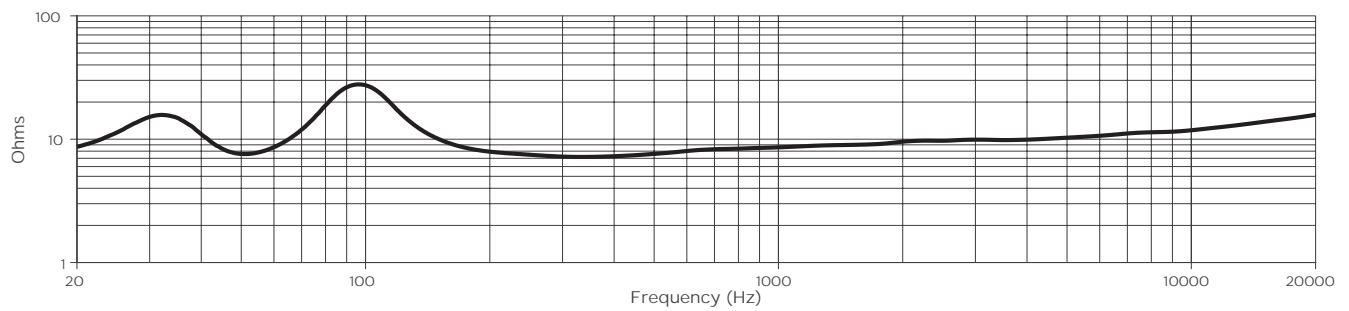

DesignMax DM8C-SUB

in-ceiling subwoofer

Dimensions

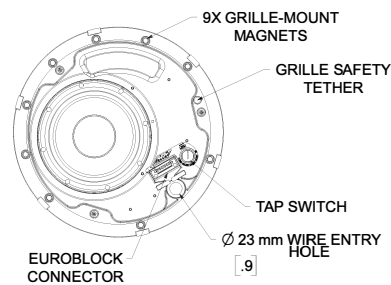
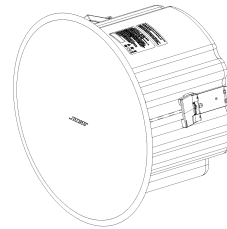
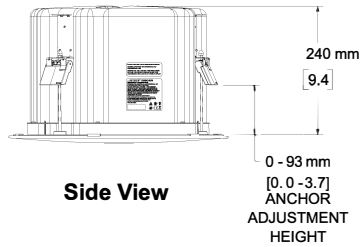

Front View
GRILLE REMOVED FOR CLARITY

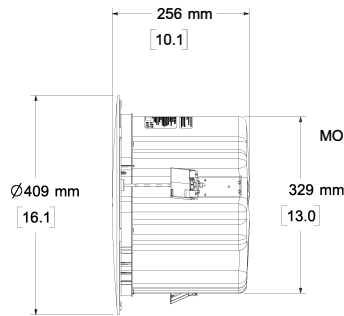

Right View
DIMENSIONS APPLY TO BOTH SIDES

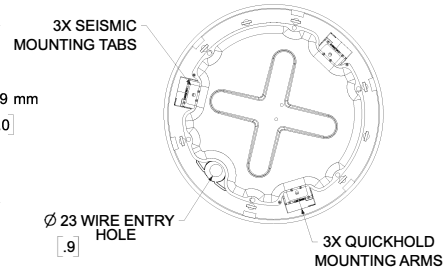

Rear View

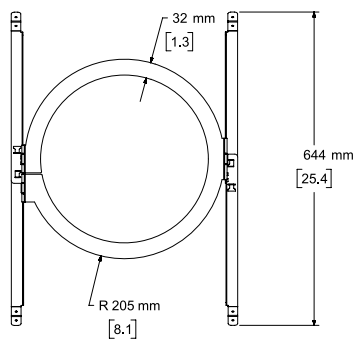

Top View

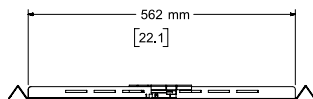

Right View
DIMENSIONS APPLY TO BOTH SIDES

- NOTES:
1. DIMENSIONS ARE IN MILLIMETERS OVER INCHES
2. WEIGHT APPROX 9.91kg [21.9lbs]

For additional specifications and application information, please visit PRO.BOSE.COM.
Specifications subject to change without notice. 10/2019