

## Counter

### Assembly Instructions

Follow these instructions for the successful assembly of your Bouncepad Counter.

Sheet Code: BP-OR-IM-016\_REV4  
Release Date: 31/07/2018

Copyright 2017 Spotspot Ltd. (T/A Bouncepad) all rights reserved. Confidential, no part of this publication may be reproduced or transmitted in any form without the written permission of the copyright holder.



**A** Counter - In the Box



**B** Counter 60 - In the Box

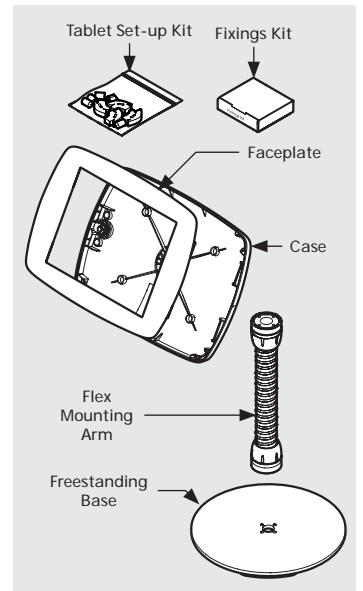

**C** Counter Flex - In the Box



**0** Tools Required



**1** Attach your chosen Mounting Arm to the Freestanding Base. Ensure the correct fixings are used for your assembly.

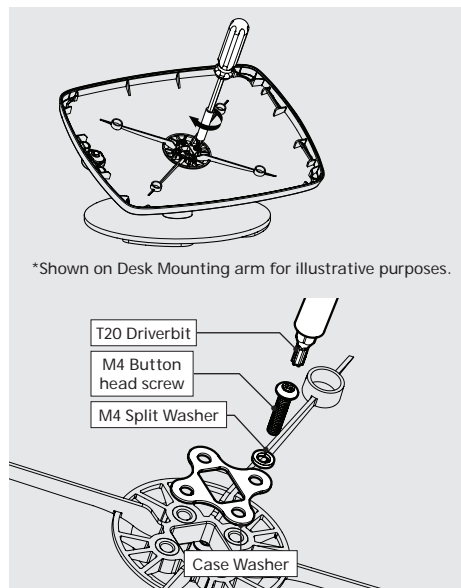

**2** Attach the Bouncepad Case to its Mounting Arm. Take care to ensure correct & full thread engagement.

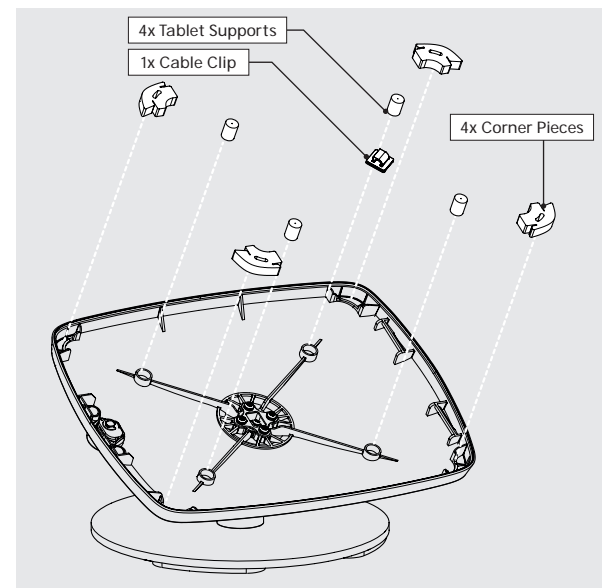

**3** Install the Tablet Setup Kit. Each kit is specific per tablet device and Bouncepad Case.

**!** If installing the optional (purchased at additional cost) Reinforced Cable, go to Step A. Install only three of the four Buttonhead screws & Split Washers in Step 2 if installing the Reinforced Cable.

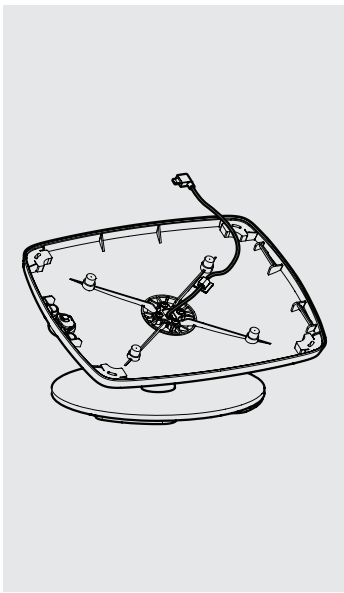

**4** Feed the cable through the Case. Connect to its power supply.

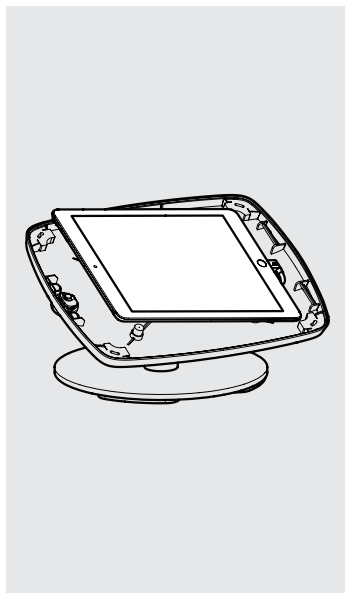

**5** Install your Tablet into the Case - connecting its power supply cable.



**6** Locate the Faceplate onto the Bouncepad Case.

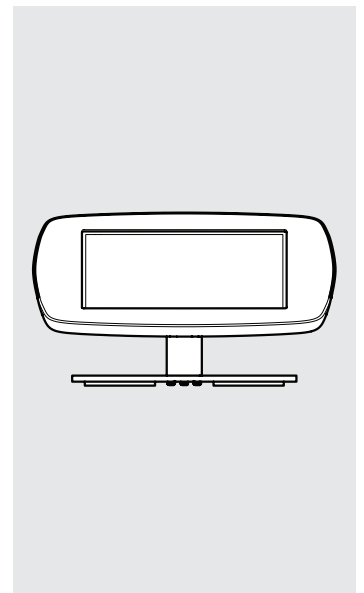

**7** Lock the Faceplate to the Case. Installation complete.

## bouncepad

### Reinforced Cable

#### Assembly Instructions

Follow these instructions for the successful assembly of your Reinforced Cable.

\*Reinforced Cable is sold (at additional cost) as an optional extra. Purchase of the Reinforced Cable negates the need for purchasing the Bouncepad Right Angle Cable.

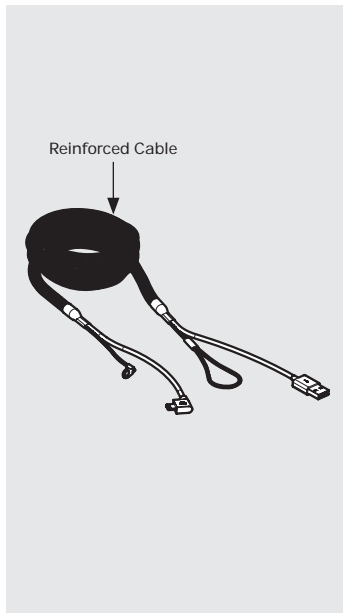

**A** Reinforced Cable - In the Box

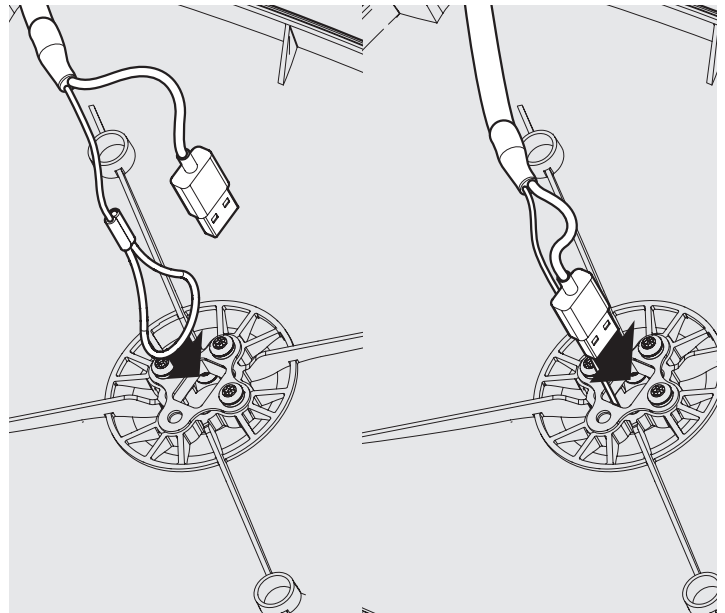

**B** Feed the looped end of the Reinforced Cable through the Case, Mounting Arm & Freestanding Base.



**C** Secure the Reinforced Cable to the Bouncepad Case with the remaining Spring Washer & Buttonhead screw.



**D** Secure the looped end of the Reinforced Cable. Must be secured next to the power socket used.

**!** Return to Step 3 to complete the installation of your Bouncepad.