

5

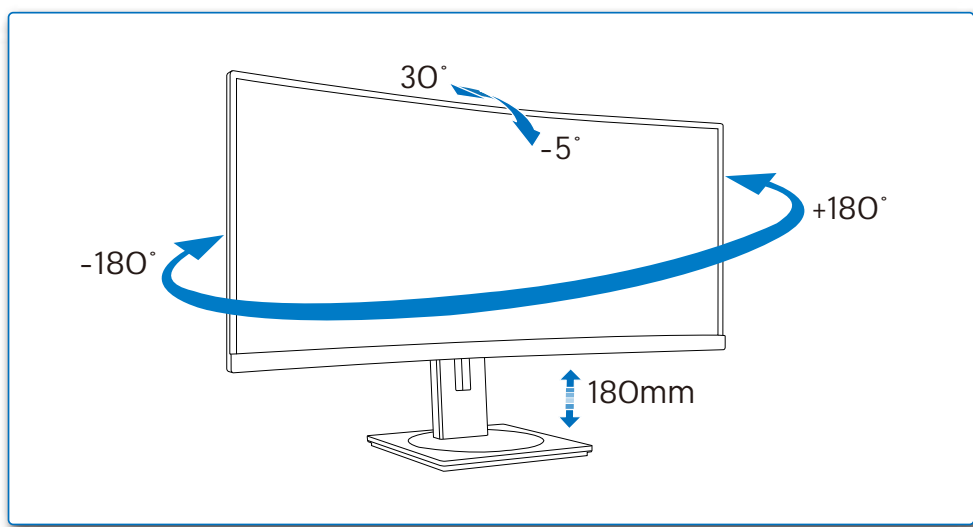

Register your product and get support at [www.philips.com/support](http://www.philips.com/support)

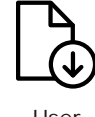

FAQ

Software SmartControl

User Manual

Version: M10346B1Q1T  
2019 © TOP Victory Investments Ltd. All rights reserved.

This product has been manufactured by and is sold under the responsibility of Top Victory Investments Ltd., and Top Victory Investments Ltd. is the warrantor in relation to this product. Philips and the Philips Shield Emblem are registered trademarks of Koninklijke Philips N.V. and are used under license.

Specifications are subject to change without notice.

**HDMI**

The terms HDMI, HDMI High-Definition Multimedia Interface, and the HDMI Logo are trademarks or registered trademarks of HDMI Licensing Administrator, Inc.

[www.philips.com](http://www.philips.com)

Energy Labelling

346B1C



Printed in China



Q41G34M181303F

PHILIPS

B Line

346B1



# Quick Start

Register your product and get support at [www.philips.com/welcome](http://www.philips.com/welcome)

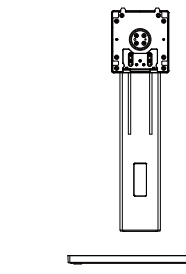
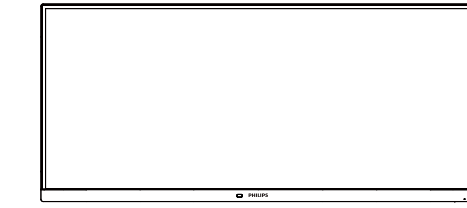

Stand/Base



\* I/O Cover



Power

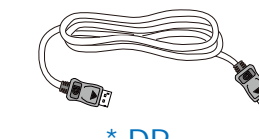

\* DP

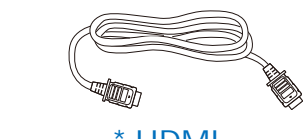

\* HDMI

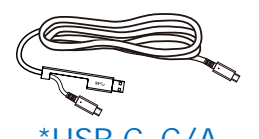

\*USB C-C/A

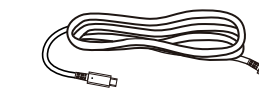

\*USB C-C

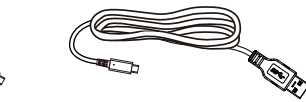

\*USB C-A

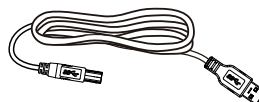

\*USB A-B

\* Different according to region.  
Display design may differ from those illustrated.

1

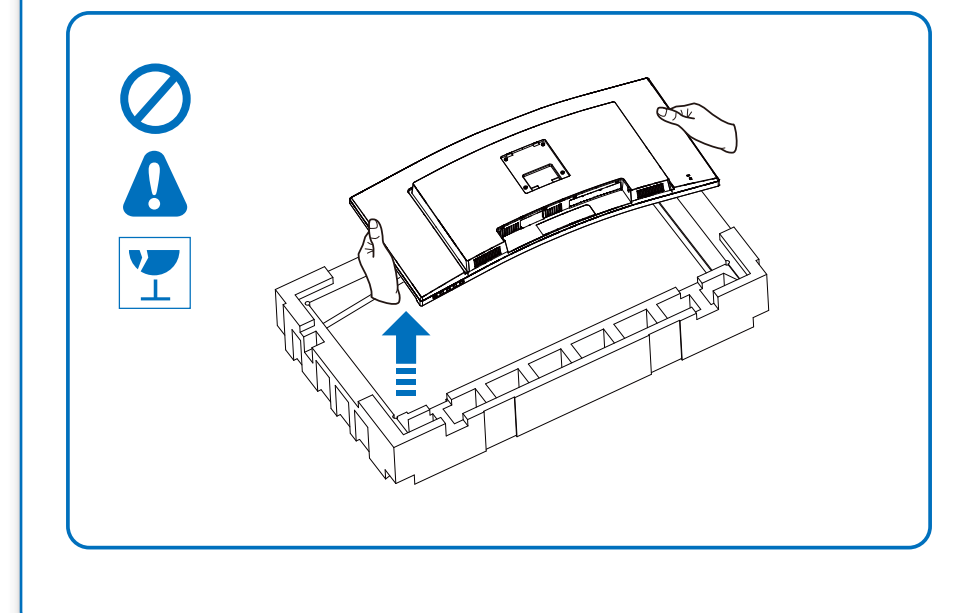
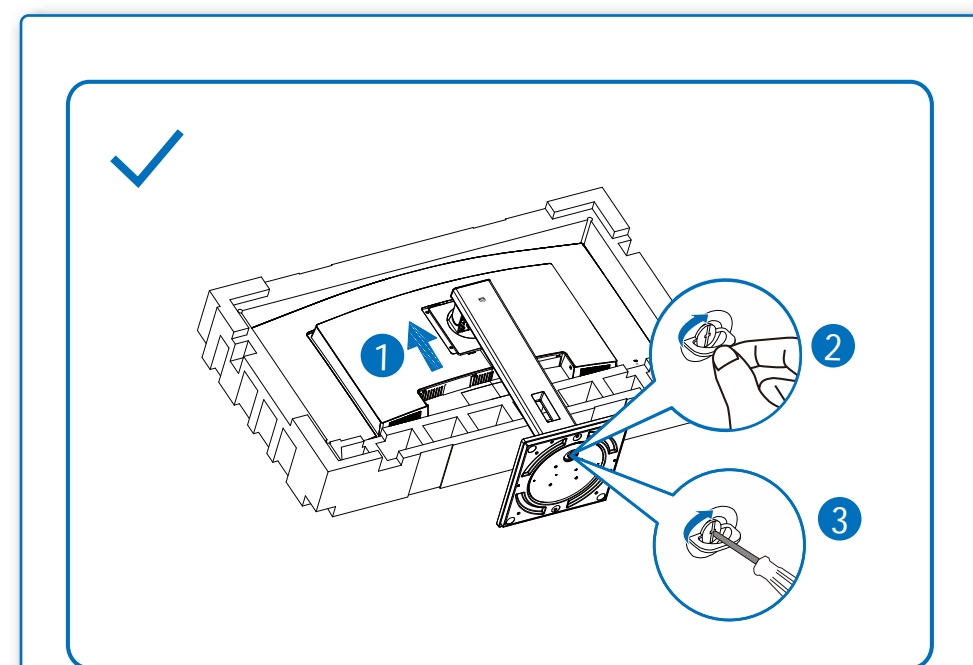

2

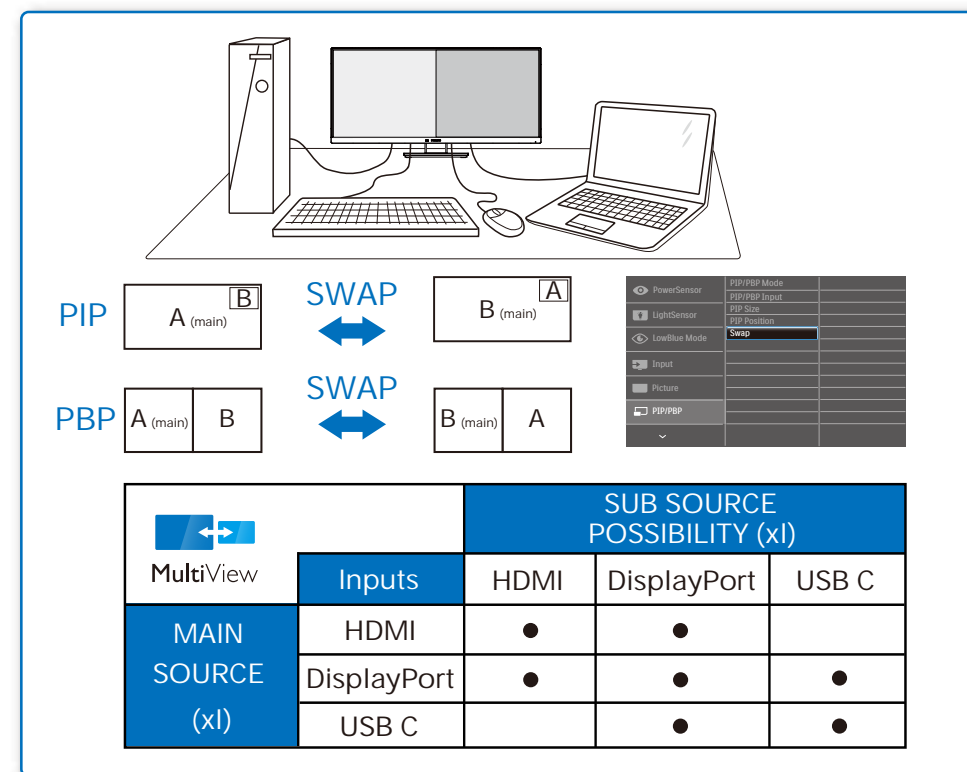
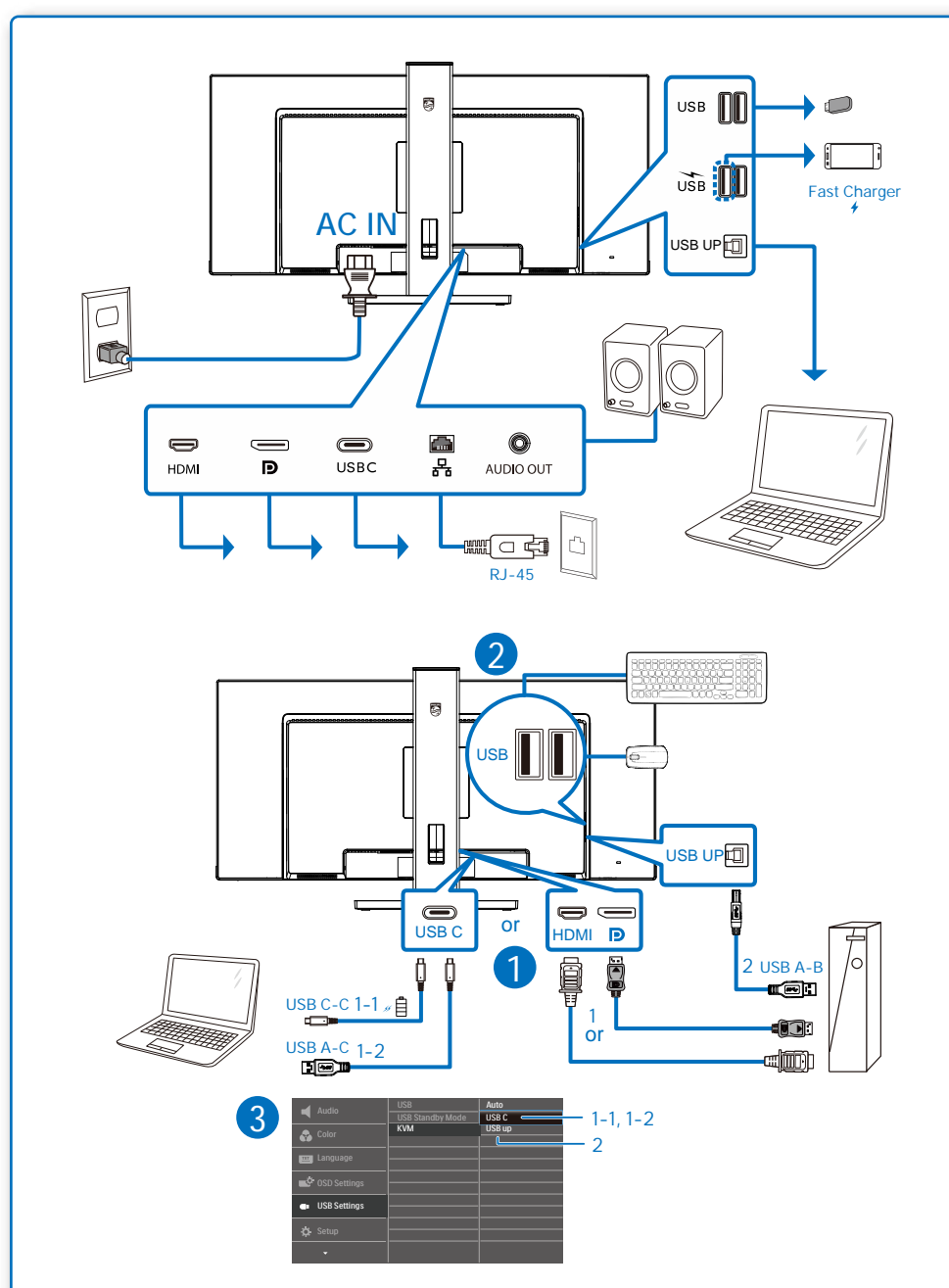

3

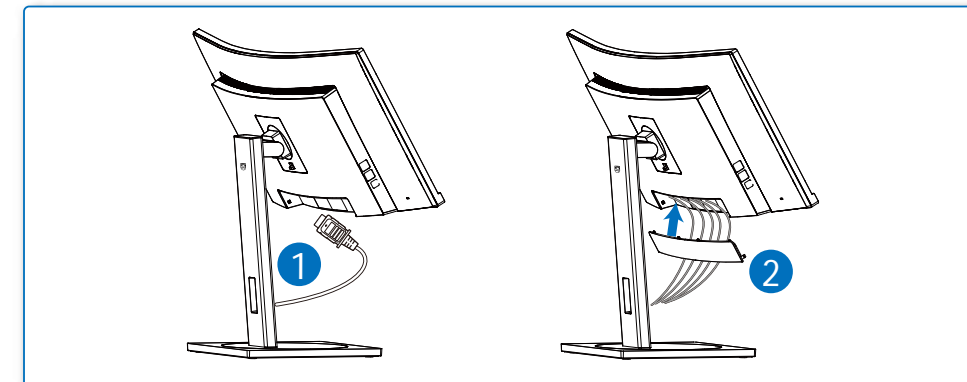

4

