

# ArenaMatch Utility AMU105

## small-format foreground/fill loudspeaker

### Product Overview

Built for zone-fill coverage or high-SPL foreground music, Bose ArenaMatch Utility loudspeakers feature similar tonal balance to ArenaMatch array modules but in compact designs. They have the same EMB2S compression driver as ArenaMatch arrays, ensuring consistent sound, and the same IP55 weather rating. Deploy them for zone-fill coverage in sports stadiums, arenas, outdoor entertainment centers, and more. Or use them to provide intelligible, high-level sound in any outdoor area — from niche venues such as breweries and fairgrounds to larger settings like resorts and outdoor shopping centers.

The AMU105 is an ultra-compact ArenaMatch Utility model for outdoor applications that require excellent audio from an unobtrusive loudspeaker. It provides wide, even coverage with a 100° x 100° constant-directivity high-frequency horn, 100 Hz – 18 kHz frequency response, 118 dB peak SPL, and supports the lowest vocal ranges with a Bose LF5 5.25-inch woofer.



### Key Features

**Deploy as zone-fill to support ArenaMatch arrays systems**, delivering powerful, intelligible sound and ensuring consistent tonal balance with EMB2S compression drivers in every speaker

**Deploy for high-level foreground music** in any outdoor venue

**Install outdoors** with an IP55 weather rating, three-layer stainless steel grille, water-resistant coating on woofer cone, industrial polyurethane exterior coating, and molded cover to protect inputs

**Adapt to a variety of configurations** — all models ship standard with 70/100V transformer inputs and passive crossover with optimized filters for more consistent frequency and polar response

**Streamline the design process** by combining with complementary Bose Professional products, such as PowerMatch amplifiers and ControlSpace DSPs

**Mount easily with included stainless-steel U-bracket**; rear enclosure panel also includes M8 threaded inserts to accept third-party accessory mounting bracket

**Provide wide, even coverage** with 100° x 100° constant-directivity high-frequency horn that provides the same coverage in either horizontal or vertical installation

**Perform in the most demanding applications** with 100 Hz – 18 kHz frequency response and 118 dB maximum peak SPL

**Support lowest vocal range** with 1x Bose LF5 5.25-inch woofer featuring a 1.5-inch long-excursion voice coil, which extends response to 90 Hz

# ArenaMatch Utility AMU105

## small-format foreground/fill loudspeaker

### Technical Specifications

Single Module Performance				
Frequency Response (-3 dB) <sup>1</sup>	100 Hz to 16 kHz			
Frequency Range (-10 dB)	90 Hz to 18 kHz			
Nominal Coverage Pattern (H x V)	100° x 100°			
Recommended High-pass Filter	90 Hz with minimum 12-dB / octave filter			
Crossover	Passive (2.0 kHz crossover frequency)			
70/100V transformer tap settings	70V: 5, 10, 20, 40, 80 W; 100V: 10, 20, 40, 80 W			
	Bose Extended Lifecycle Test <sup>2</sup>		AES Transducer Test <sup>3</sup>	
Power Handling, long-term continuous	100 W		150 W	
Power Handling, peak	400 W		600 W	
	Free field	Wall/Ceiling	Free field	Wall/Ceiling
Sensitivity (SPL / 1W @ 1 m) <sup>4</sup>	90 dB	92 dB	90 dB	92 dB
Calculated Maximum SPL @ 1 m <sup>5</sup>	110 dB	112 dB	111 dB	113 dB
Calculated Maximum SPL @ 1 m, peak	116 dB	118 dB	117 dB	119 dB
Transducers				
Low Frequency	1x Bose LF5 high-excursion 5.25-inch woofer (1.5-inch voice coil)			
High Frequency	1x Bose EMB2S extended high-frequency compression driver (2-inch voice coil)			
Nominal Impedance	8			
Physical				
Enclosure Material	Exterior-grade plywood			
Finish	Two-part spray polyurea coating, black or white			
Grille	3-layer: perforated stainless steel, acoustic foam, stainless steel mesh, powder-coat finish			
Environmental	IEC 60529 IP55 for outdoor, direct-exposure installations			
Connectors	1x barrier strip, (accepts 10 to 18 wire gauge)			
Suspension/Mounting	2x M8 threaded inserts for U-bracket; 2x M8 threaded inserts on rear (75 mm, 2-bolt pattern)			
Dimensions (H x W x D)	152 x 304 x 229 mm (6.0 x 12.0 x 9.0 in) with input cover			
Net Weight	6.5 kg (14.4 lb) / 7.5 kg (16.5 lb) with u-bracket			
Shipping Weight	9.5 kg (21.0 lb)			
Accessories	Optional pan-and-tilt bracket			
Product Code				
Black	811433-0110			
White	811433-0210			

#### Footnotes

- (1) Frequency response and range measured on-axis in anechoic environment with recommended bandpass and EQ.
- (2) Bose extended-lifecycle test using pink noise filtered to meet IEC268-5, 6-dB crest factor, 500-hour duration.
- (3) AES standard 2-hour duration with IEC system noise.
- (4) Sensitivity measured in anechoic environment with recommended bandpass and EQ.
- (5) Maximum SPL calculated using sensitivity and power ratings, exclusive of power compression.

# ArenaMatch Utility AMU105

small-format foreground/fill loudspeaker

## Frequency Response

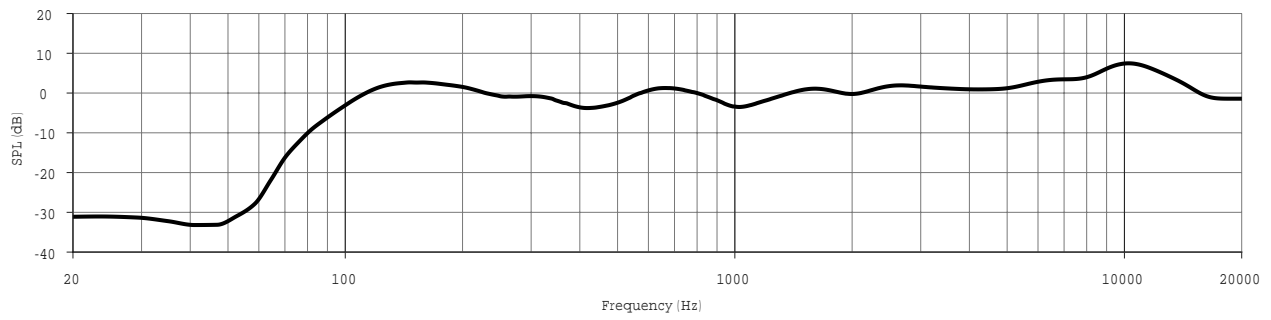

## Beamwidth

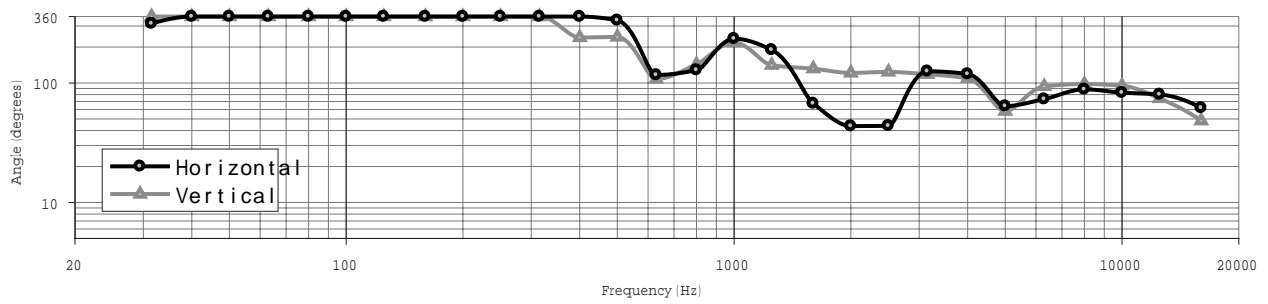

# ArenaMatch Utility AMU105

small-format foreground/fill loudspeaker

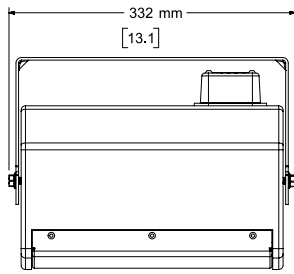

**Top View**

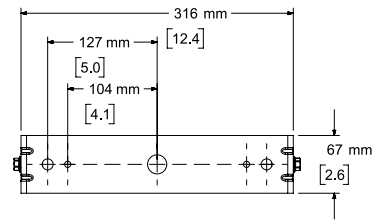
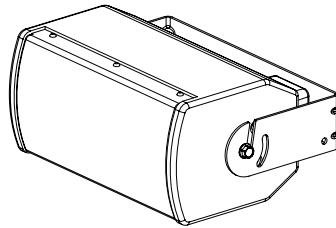

**Rear View**  
BRACKET ONLY



**Front View**

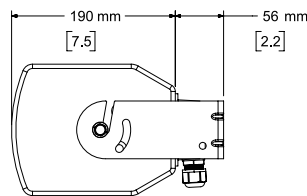

**Right View**  
DIMENSIONS APPLY TO BOTH SIDES

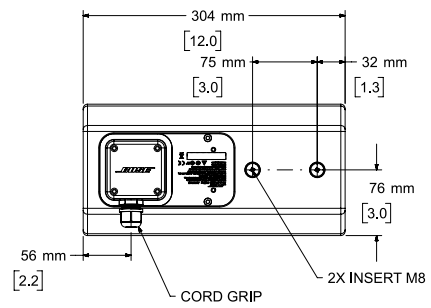

**Rear View**  
BRACKET REMOVED FOR CLARITY

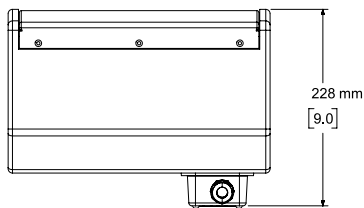

**Bottom View**  
BRACKET REMOVED FOR CLARITY

- NOTES:
1. DIMENSIONS ARE IN MILLIMETERS OVER INCHES
  2. WEIGHT APPROX. 6.5kg [14.4lbs] (SPEAKER ONLY)  
WEIGHT W/BRACKET 7.4kg [16.4lbs]