

BGR Series

19" gangable enclosures

next generation rack, designed with significant installation and performance benefits

features:

- Provides more rackspace in a smaller overall height than similar racks
- Accepts patent-pending Lever Lock™ tool free and hardware free internal device and cable management system accessories
- Fully welded construction provides the following weight capacities:
UL Listed load capacity: 3,000 lbs., Seismic certified capacity: 1,175 lbs.
- Pre-threaded ganging holes allow for rack joining after loading
- Rackrail depth indicators
- 1/2", 3/4", 1" & 1-1/2" electrical knockouts and 5/8" and 1/2" D UHF/VHF antennae knockouts on rear top & bottom, easily removable for cable pass-through. Top cable management plate (38 space and up) includes 1/2", 3/4", 1" 1-1/2" & 3" electrical knockouts and 5/8" and 1/2" D UHF/VHF antennae knockouts
- 23" OD width, multiple depths
- Two pairs of 11-gauge, 10-32 threaded rackrail with numbered rackspace increments
- Optional stackable 3" extender bay available for front and rear
- Optional curved and beveled front doors in solid, vented and plexiglass styles
- Attractive interior bevels
- Configurable open top with vertical cable management entry points
- Durable black textured powder coat finish
- Seismic certified (when used with BGR-Z4 or BGR-ISO-Z4 option) with an Ip value of 1.5
- UL Listed in the US and Canada



PRODUCT CERTIFIED FOR
LOW CHEMICAL EMISSIONS
UL.COM/GG
UL 2818



PEP
ECO
PASS
PORT®

what great systems are built on.™

A brand of **legrand**

Middle Atlantic Products

middleatlantic.com | middleatlantic.ca

96-01149 / rev d / 12-5-16

BGR Series

19" gangable enclosures

specifications:

EIA compliant 19" gangable equipment rack shall be Middle Atlantic Products model #BGR-___-___ (see chart for available models). Overall dimensions of BGR shall be ___"H x 23"W x ___"D (refer to chart). Useable height of BGR shall be ___ rackspaces, useable depth shall be ___" (refer to chart). BGR shall come equipped with two pairs of fully adjustable steel rackrail with tapped 10-32 mounting holes in universal EIA spacing, black e-coat finish and numbered rackspaces. BGR shall have .100" thick steel along rackrail brackets, .310" thick steel at corners. BGR shall include vented locking and latching rear door, which shall be capable of accepting up to six 4-1/2" fans. Top and bottom of BGR shall feature vertical slotted vent pattern for ventilation. BGR shall have two 1" x 7" rear obround knockouts with 1/2", 1", 1-1/4" and 1-1/2" electrical knockouts and 5/8" and 1/2" D UHF/ VHF antennae knockouts in base and top. BGR shall have a configurable open top with vertical cable management entry points. BGR shall accept patent-pending LeverLock™ tool free and hardware free internal cable and device management system accessories. BGR shall have pre-threaded 5/16"-18 ganging holes. BGR shall be capable of ganging while fully loaded, using bolts only. BGR shall have marked rackrail depth indicators. BGR shall be of fully welded construction. BGR shall be finished in an environmentally friendly, durable black powdercoat. Grounding and bonding studs shall be 1/4-20 threaded, installed in top and base of enclosure (19 and 25 space have stud in bottom only). Fully welded construction shall provide a static capacity of 12,000 lbs. and a UL Listed load capacity of 3,000 lbs. BGR Series enclosures shall satisfy the 1997 UBC; 2001, 2007 & 2010 CBC; 2000, 2003, 2006 & 2009 IBC; ASCE 7-02, ASCE 7-05, ASCE 7-10 and the 2003, 2006 & 2009 editions of NFPA 5000 for use in areas of high seismicity, Seismic Use Group III, Zone 4 or Seismic Design Category (SDC) "D" with lateral force requirements for protecting 1,175 lbs. of essential equipment in locations with the highest level of seismicity and top floor or rooftop installations with an Importance factor (Ip) of 1.5 when used with BGR-Z4 or BGR-ISO-Z4 (isolated) seismic floor anchor bracket. BGR shall be OSHPD approved for fixed equipment anchorage in California healthcare facilities. BGR shall be UL Listed in the US and Canada. BGR shall be GREENGUARD Gold Certified. BGR enclosure shall meet the RoHS EU Directive 2011/65/EU. BGR shall be manufactured by an ISO 9001 and ISO 14001 registered company. BGR enclosure shall be warrantied to be free from defects in material or workmanship under normal use and conditions for the lifetime of the rack.

Customizable specification clips available at middleatlantic.com

Part #	Rackspaces	"A" Overall Height	"B" Racking Height	"C" Depth	"D" Useable Depth
BGR-1927	19	37.375 [949]	33.375 [848]	27 [686]	24.4 [620]
BGR-2527	25	47.875 [1216]	43.875 [1114]	27 [686]	24.4 [620]
BGR-3827	38	70.625 [1794]	66.625 [1692]	27 [686]	24.4 [620]
BGR-4127	41	75.875 [1927]	71.875 [1826]	27 [686]	24.4 [620]
BGR-4527	45	82.875 [2105]	78.875 [2003]	27 [686]	24.4 [620]
BGR-2532	25	47.875 [1216]	43.875 [1114]	32 [812]	29.4 [747]
BGR-3832	38	70.625 [1794]	66.625 [1692]	32 [812]	29.4 [747]
BGR-4132	41	75.875 [1927]	71.875 [1826]	32 [812]	29.4 [747]
BGR-4532	45	82.875 [2105]	78.875 [2003]	32 [812]	29.4 [747]
BGR-4138	41	75.875 [1927]	71.875 [1826]	38 [965]	35.4 [899]
BGR-4538	45	82.875 [2105]	78.875 [2003]	38 [965]	35.4 [899]

options:

- Lever Lock™ tool free and hardware free internal device and cable management system accessories shall be model # LL-XXYY (XX = type, YY = size, refer to middleatlantic.com for additional details)
- Curved front doors shall be model # VFD-XXA (vented, 64% open area), PFD-XXA (plexi), (XX = # of rackspaces)
- Beveled front doors shall be model # BFD-XX (solid), BVFD-XX (vented, 64% open area), BPF-XX (plexi), (XX = # of rackspaces)
- Front or Rear Extender, adds 3" of usable depth, model # BGR-___-EXT3 (41,45)
- Cable entry rear door, shall be model # BGR-RDC___ (19, 25, 38, 41, 45)
- Inner platform base shall be BS-BGR
- Caster kit shall add 1" to overall height, include four casters with a 1,100 lb. weight capacity, and shall be model # CBS-BGR
- Rear rail kit shall be model # BGR-RRXX (XX=# of rackspaces)
- Removable keylocked side panels shall be model # BSPN-XX-YY (XX=rackspaces, YY=depth)
- Seismic Zone 4, Seismic Use Group III and Seismic Design Category "D" compliancy kit shall be model # BGR-Z4
- Seismic Zone 4, Seismic Use Group III and Seismic Design Category "D" compliancy and isolation kit shall be model # BGR-ISO-Z4
- Seismic Zone 4, Seismic Use Group III and Seismic Design Category "D" riser bases shall be SRB-(1,2,3)-BGR-(32, 38)24
- Isolation kit shall be model # BGR-ISO
- Front decorative trim shall be BGR-TRIM__(45,41,38, 25, 19) and shall include the following colors: Green (pre-installed), Red, Black, Blue & White

BGR Series

basic dimensions

all dimensions in inches unless otherwise noted [all dimensions in brackets are in millimeters]

top view

38sp & over

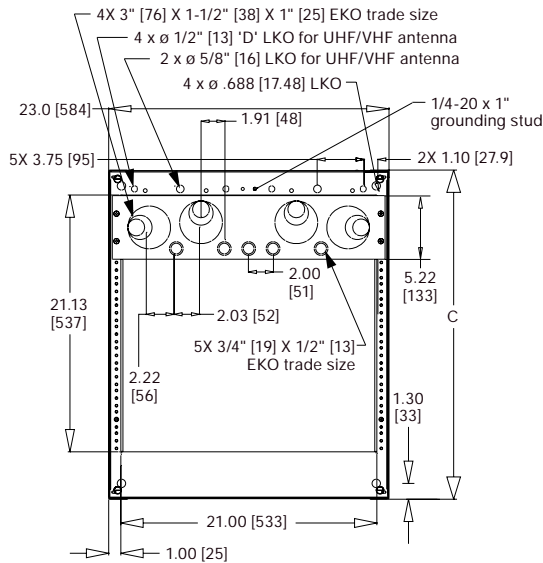

top view

25sp & under

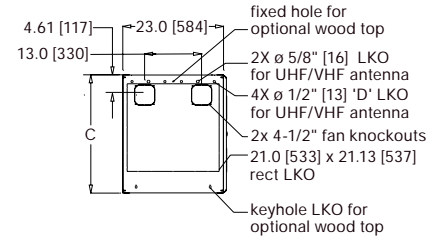

bottom view

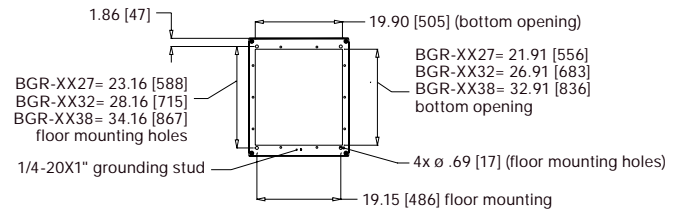

front view

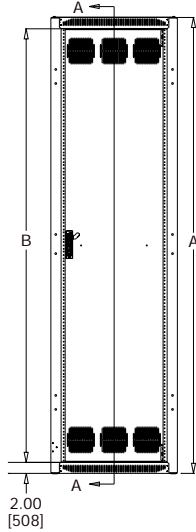

side view

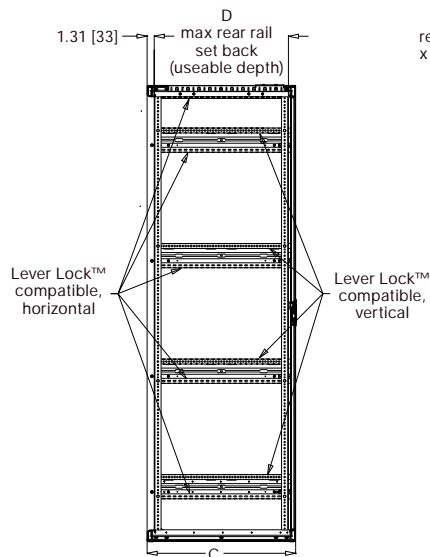

rear view

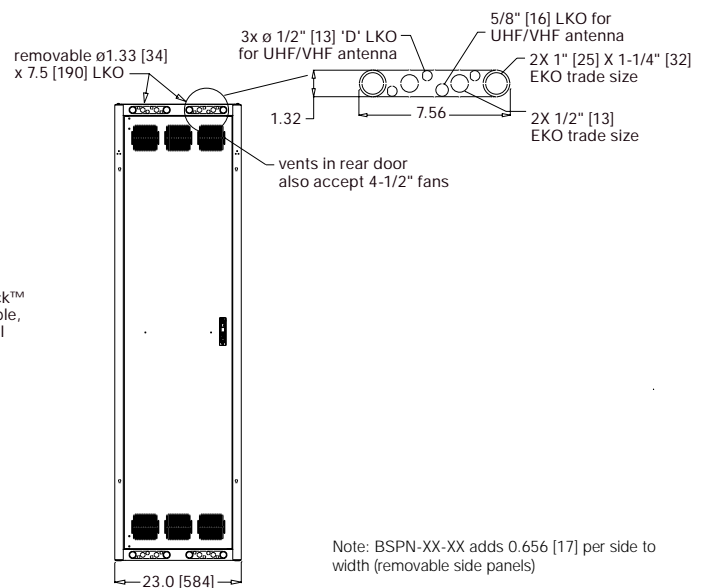

Note: BSPN-XX-XX adds 0.656 [17] per side to width (removable side panels)

what great systems are built on.™

A brand of **legrand**

Middle Atlantic Products

middleatlantic.com | middleatlantic.ca

BGR Series

curved & beveled doors basic dimensions

all dimensions in inches unless otherwise noted [all dimensions in brackets are in millimeters]

curved doors

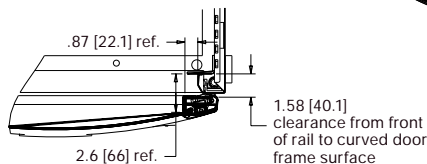
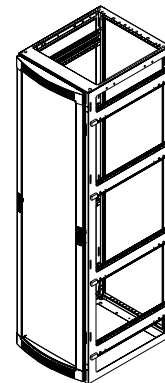
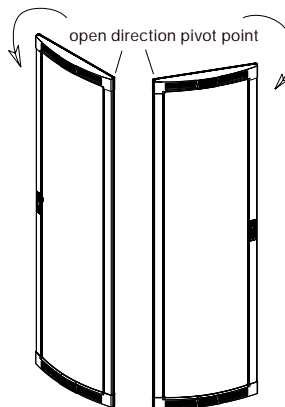
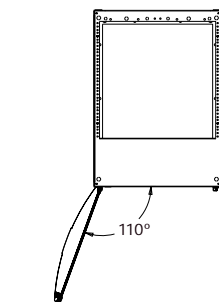
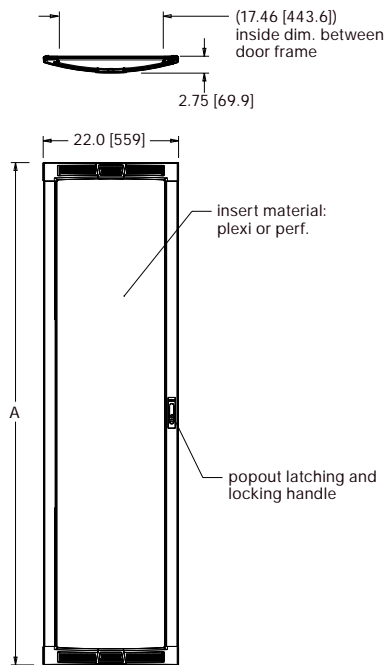

Vented Door	Plexi Door	Rackspaces	A Height
VFD-19A	PFD-19A	19	35.97 [913]
VFD-25A	PFD-25A	25	46.47 [1180]
VFD-38A	PFD-38A	38	69.22 [1758]
VFD-41A	PFD-41A	41	74.47 [1891]
VFD-45A	PFD-45A	45	81.47 [2069]

beveled doors

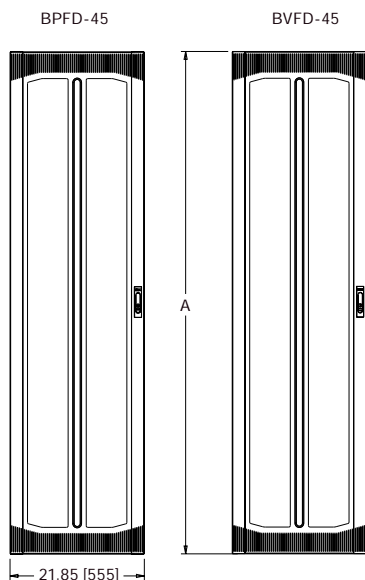

clearance from front of rail to inside of door

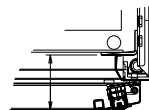

BFD-XX 2.79 [71]
BVFD-XX 2.74 [70]
BPFD-XX 2.60 [66]

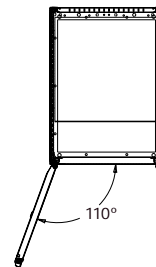

Solid Door	Vented Door	Plexi Door	Rackspaces	A Height
BFD-19	BVFD-19	BPFD-19	19	36.22 [920]
BFD-25	BVFD-25	BPFD-25	25	46.72 [1187]
BFD-38	BVFD-38	BPFD-38	38	69.47 [1765]
BFD-41	BVFD-41	BPFD-41	41	74.72 [1898]
BFD-45	BVFD-45	BPFD-45	45	81.72 [2076]

what great systems are built on.™

A brand of **legrand**

MA

Middle Atlantic Products

middleatlantic.com | middleatlantic.ca

BGR Series

front/rear extender & cable chase basic dimensions

all dimensions in inches unless otherwise noted [all dimensions in brackets are in millimeters]

front/rear extender

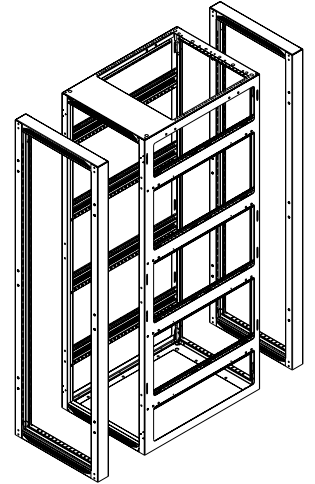
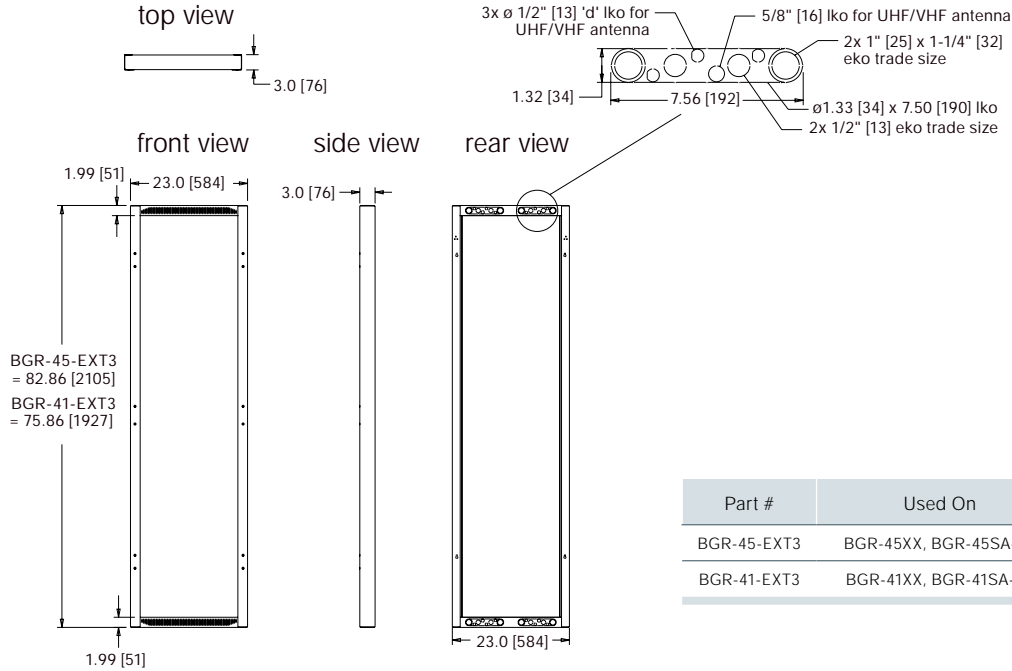

Part #	Used On
BGR-45-EXT3	BGR-45XX, BGR-45SA-XX
BGR-41-EXT3	BGR-41XX, BGR-41SA-XX

cable chase

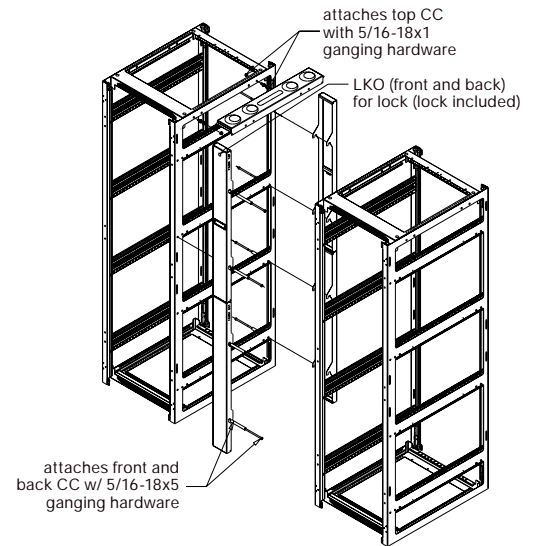
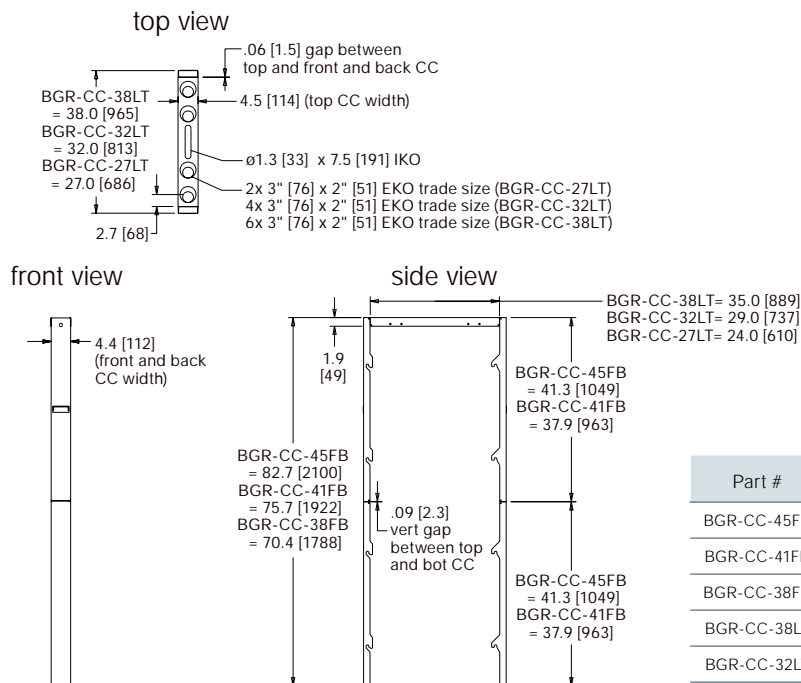

Part #	Used On
BGR-CC-45FB	BGR-45XX, BGR-45SA-XX
BGR-CC-41FB	BGR-41XX, BGR-41SA-XX
BGR-CC-38FB	BGR-38XX, BGR-38SA-XX
BGR-CC-38LT	BGR-XX38
BGR-CC-32LT	BGR-XX32, BGR-XXSA-32
BGR-CC-27LT	BGR-XX27, BGR-XXSA-27

what great systems are built on.™

A brand of **legrand**

Middle Atlantic Products

middleatlantic.com | middleatlantic.ca

BGR Series

fan top & top panel/rail basic dimensions

all dimensions in inches unless otherwise noted [all dimensions in brackets are in millimeters]

BGR-552FT-FC shown

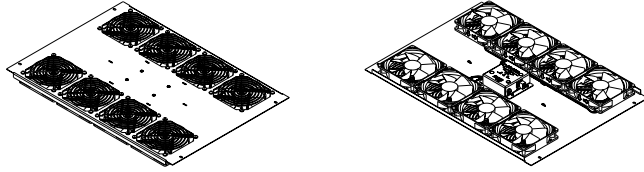

BGR-276FT shown

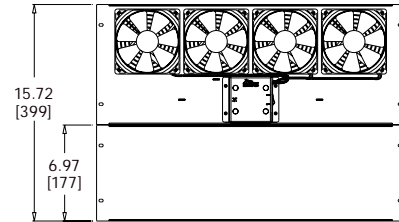
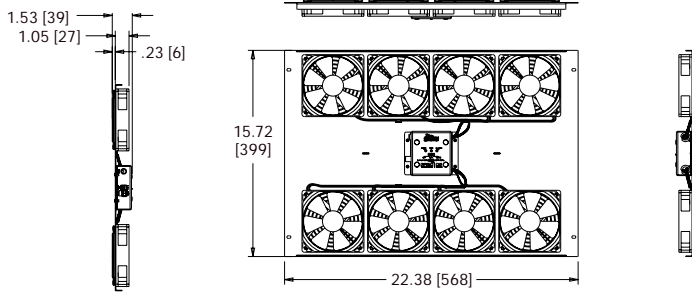
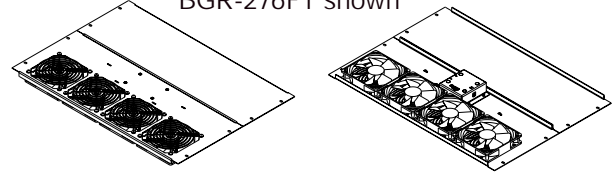

Part #	Fan Control	Fan Quantity	Airflow CFM [M3/MIN]	Noise @ Full Speed	Current Draw
(I) BGR-276FT		4	276 [7.8]	35dBa	620 mA @ 12VDC
(I) BGR-276FT-FC	X	4	276 [7.8]	35dBa	620 mA @ 12VDC
(I) BGR-552FT		8	552 [15.6]	38dBa	1.24A @ 12 VDC
(I) BGR-552FT-FC	X	8	552 [15.6]	38dBa	1.24A @ 12 VDC

- Note:
1. Turn on temperature for fan controlled models can be set at 75°F (24°C), 80°F (27°C), 85°F (29°C), or 90°F (32°C). Alarm can be set at 95°F (35°C) or 100°F (38°C).
 2. "I" prefix indicates international fan top models. International models come with a universal voltage plug-in power supply and adapters.

Top Panel/Rail

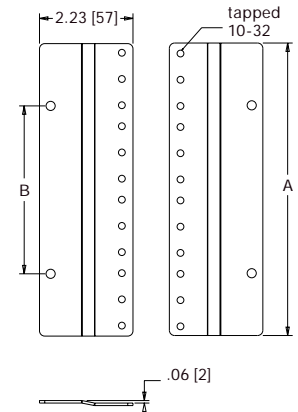
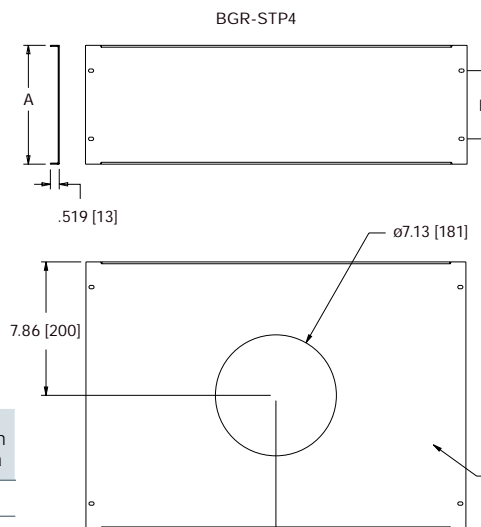
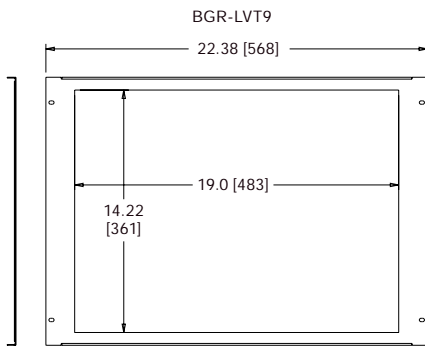

BGR-DT9, for use with DUCT-COOL-1PT and DUCT-COOL-2PT

Part #	A	B	Type	Material	Open Area
BGR-STP3	5.22 [133]	2.25 [57]	solid	aluminum	-
BGR-STP4	6.97 [177]	4.00 [102]	solid	aluminum	-
BGR-STP9	15.72 [399]	12.75 [324]	solid	steel	-
BGR-LVT9	15.72 [399]	12.75 [324]	vented	steel	64%
BGR-DT9	15.72 [399]	12.75 [324]	duct top	steel	-

Part #	A	B	Rackspaces
BGR-TRR4	6.97 [177]	4.00 [102]	4
BGR-TRR9	15.72 [399]	12.75 [324]	9

BGR Series

caster base / inner platform base basic dimensions

all dimensions in inches unless otherwise noted [all dimensions in brackets are in millimeters]

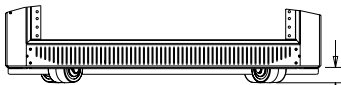
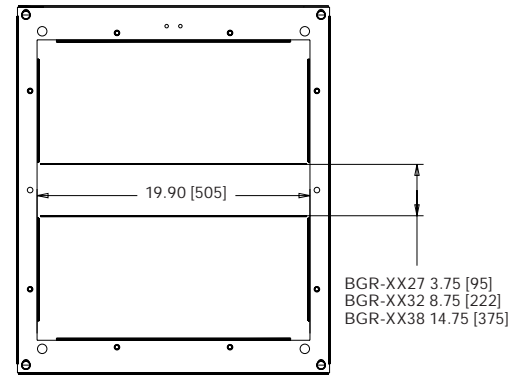
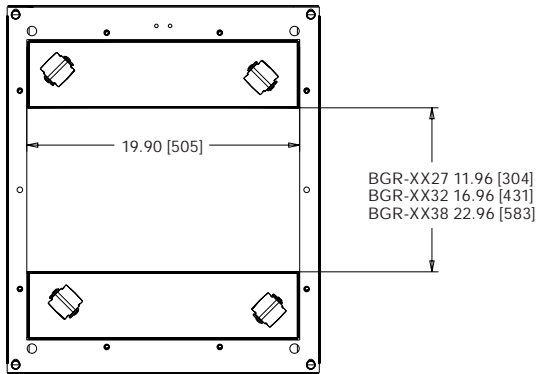
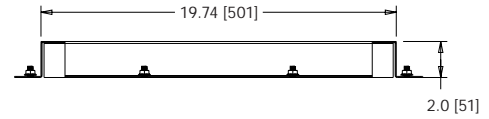
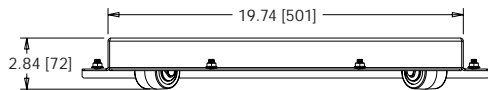
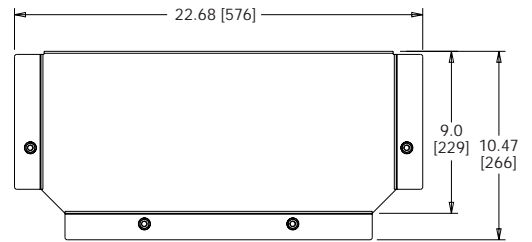
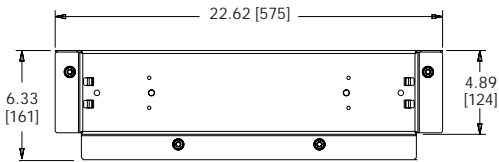
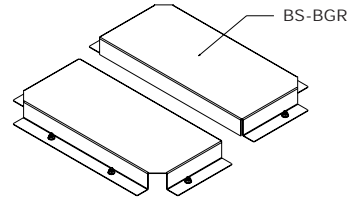
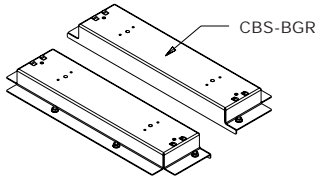

installing casterbase to rack will increase overall height by 1.12 [28]

what great systems are built on.™

A brand of **legrand**



Middle Atlantic Products
middleatlantic.com | middleatlantic.ca

BGR Series

cable entry rear door basic dimensions

all dimensions in inches unless otherwise noted [all dimensions in brackets are in millimeters]

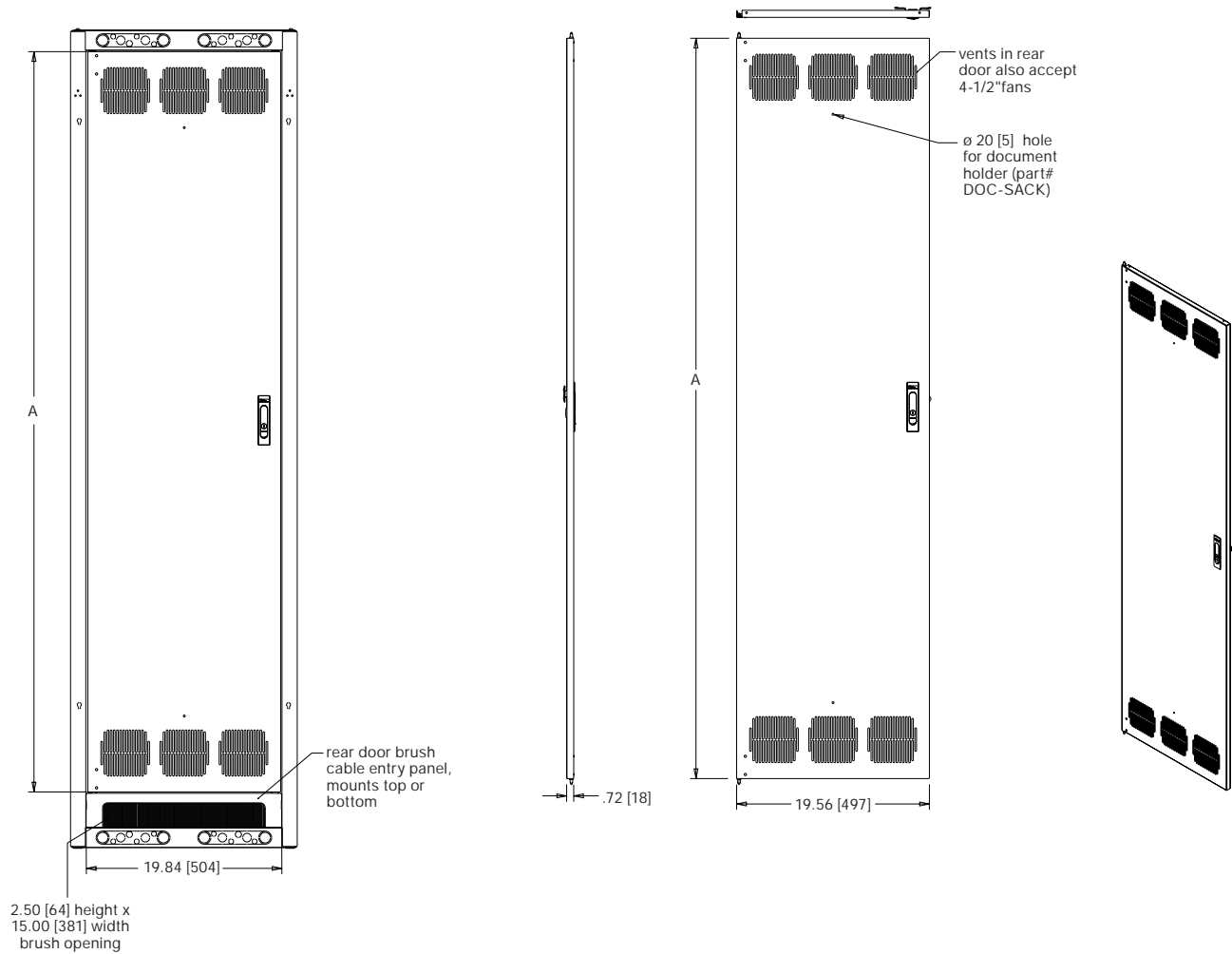

Part #	Used On	"A" Height
BGR-RDC19	BGR-19XX, BGR-19SA-XX	29.59 [752]
BGR-RDC25	BGR-25XX, BGR-25SA-XX	40.09 [1018]
BGR-RDC38	BGR-38XX, BGR-38SA-XX	62.84 [1596]
BGR-RDC41	BGR-41XX, BGR-41SA-XX	68.09 [1730]
BGR-RDC45	BGR-45XX, BGR-45SA-XX	75.09 [1907]

what great systems are built on.™

A brand of **legrand**

Middle Atlantic Products

middleatlantic.com | middleatlantic.ca