

Kensington®

Desktop & Peripherals Locking Kit 2.0

INSTRUCTION GUIDE
GUIDE D'INSTRUCTIONS
BEDIENUNGSANLEITUNG
HANDLEIDING
MANUALE DI ISTRUZIONI
MANUAL DE INSTRUCCIONES

HASZNÁLATI ÚTMUTATÓ
P ÍRU KAS POKYNY
INSTRUKCJA OBSŁUGI

MANUAL DE INSTRUÇÕES

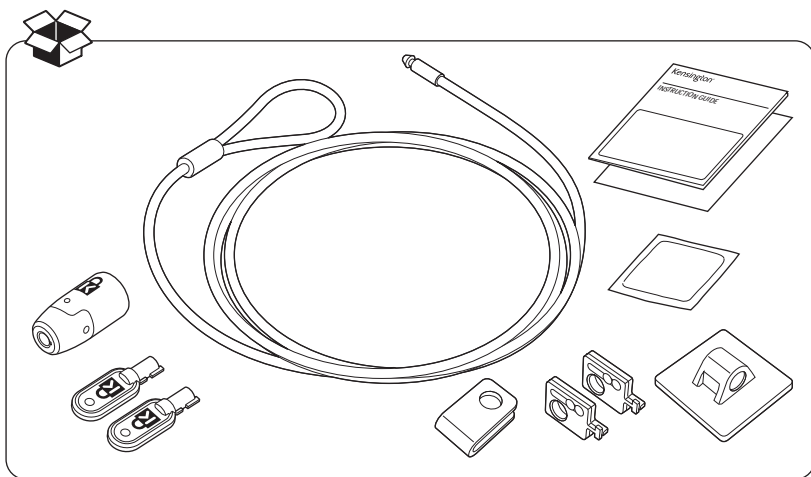

Register Now!
Enregistrer maintenant !
Jetzt registrieren!
Nu registreren
Registrar ahora
Registra adesso

Regisztráljon most!
Zaregistrujte se nyní!
Zarejestruj si !

Registe-se agora!
!

www.kensington.com/register



IMPORTANT! REGISTER YOUR KEY CODE! /
IMPORTANT! ENREGISTREZ VOTRE CODE CLÉ! /
WICHTIG! REGISTRIEREN SIE IHREN KEYCODE! /
BELANGRIJK! REGISTREER UW SLEUTELCODE! /
IMPORTANTE! EFFETTUARE LA REGISTRAZIONE DEL
CODICE DELLA CHIAVE /
IMPORTANTE: REGISTRE EL CÓDIGO DE LA LLAVE /
FONTOS! REGISZTRÁLJA A KULCSKÓDJÁT! /
D LEŽITÉ! REGISTRUJTE KÓD SVÉHO KLÍ E! /
WA NE! ZAREJESTRUJ KOD KLUCZYKA! /
! /
IMPORTANTE! FAÇA O REGISTO DO SEU CÓDIGO CHAVE! /
! /

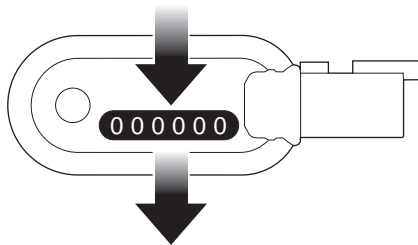

www.kensington.com/register

#

--	--	--	--	--	--

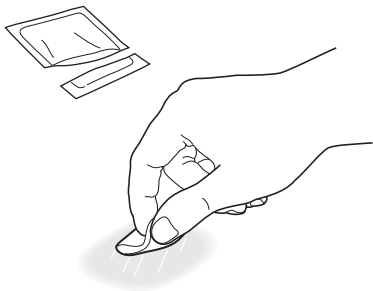
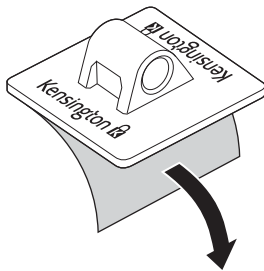
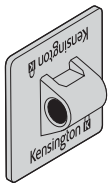
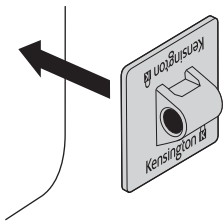
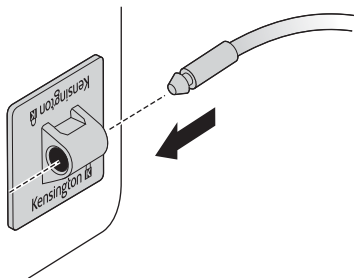
B**1****2****3****4**

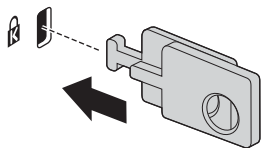
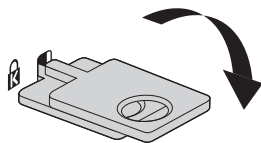
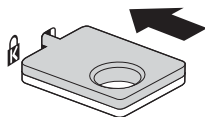
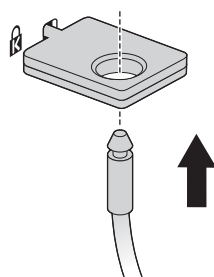
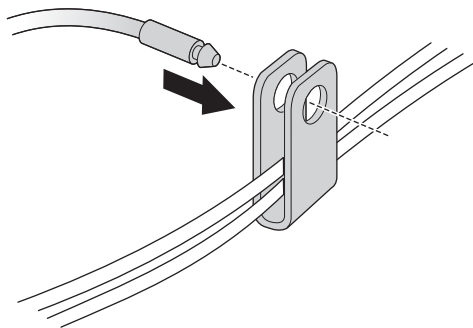
C**1****2****3****4****D**

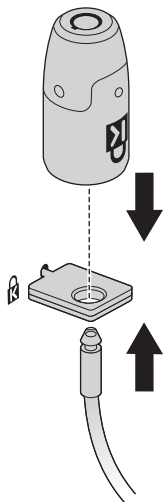
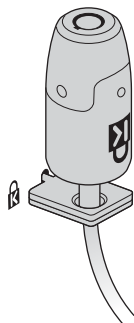
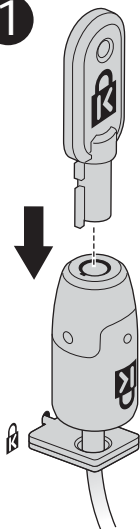
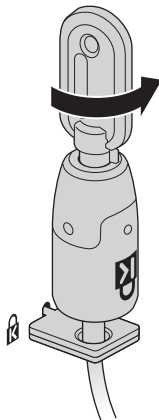
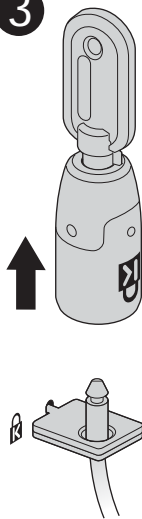
E**1****2****1****2****3**

Sold separately. Visit www.kensington.com /
Vendu séparément. Visitez le site www.kensington.com /
Wird separat verkauft. Weitere Informationen finden Sie unter www.kensington.com /
Afzonderlijk verkrijgbaar. Ga naar www.kensington.com /
Disponibile separatamente. Visitare il sito www.kensington.com /
Se venden por separado. Visite www.kensington.com /
Külön értékesítve. Keresse fel a www.kensington.com /
Lze zakoupit zvlášť. Navštivte www.kensington.com /
Sprzedawane osobno. Odwied www.kensington.com /
www.kensington.com /
Vendido em separado. Visite www.kensington.com /
www.kensington.com

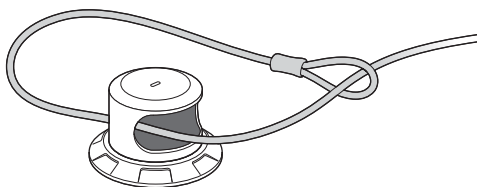

K64162

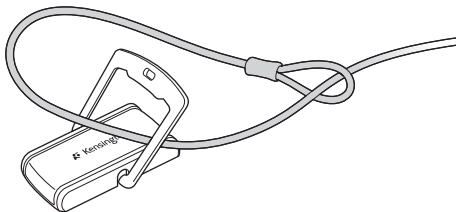

K64163

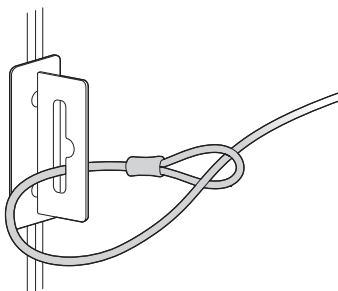

K67700

Kensington and the ACCO name and design are registered trademarks of ACCO Brands. All other registered and unregistered trademarks are the property of their respective owners.

©2017 Kensington Computer Products Group, a division of ACCO Brands. Any unauthorized copying, duplicating, or other reproduction of the contents hereof is prohibited without written consent from Kensington Computer Products Group. All rights reserved. 02/17



Kensington Computer Products Group
A Division of ACCO Brands
1500 Fashion Island Blvd, 3rd Floor
San Mateo, CA 94404



ACCO Brands Europe
A Division of ACCO Brands Europe
Oxford House, Oxford Road
Aylesbury, Buckinghamshire,
HP21 8SZ
United Kingdom

**Importado por ACCO Mexicana
S.A. de C.V.**
Circuito de la Industria Norte # 6,
Corredor Industrial Toluca Lerma,
Lerma México Cp. 52004
R.F.C. AME640229-1W3

ACCO Brands Canada Inc
7381 Bramalea Rd
Mississauga,
ON L5S 1C4
Canada

Acco Brands Chile S.A.,
Avda. San Josemaria
Escrivá de Balaguer N°5773
Vitacura, C.P. 7640970
Santiago, Chile

ACCO Brands Australia - Kensington
2 Coronation Avenue
Kings Park NSW 2148
Australia

Importado e Distribuído por:
TILIBRA PRODUTOS DE PAPELARIA LTDA.
CNPJ: 44.990.901/0001-43
Rua Aymorés, 6-9 – Bauru/SP – Brasil
CEP 17013-900

www.kensington.com

K64424/K64425/K67990

901-9318-00