



by Schneider Electric

Installation Guide Smart-UPS™ X 750/1000/1500 VA Rack-Mount 2U

Important Safety Messages

Read the instructions carefully to become familiar with the equipment before trying to install, operate, service or maintain it. The following special messages may appear throughout this manual or on the equipment to warn of potential hazards or to call attention to information that clarifies or simplifies a procedure.



The addition of this symbol to a Caution product safety label indicates that a hazard exists that can result in injury and product damage if the instructions are not followed.

The following safety messages may appear throughout this manual to warn of potential hazards.

CAUTION

CAUTION indicates a potentially hazardous situation which, if not avoided, **can result in** equipment damage and minor or moderate injury.

CAUTION

CAUTION indicates a potentially hazardous situation which, if not avoided, **can result in** equipment damage.

Safety and General Information

Inspect the package contents upon receipt. Notify the carrier and dealer if there is any damage.

Read the Safety Guide supplied with this unit before installing the UPS.

- Adhere to all local and national electrical codes.
- This UPS is intended for indoor use only.
- Do not operate this UPS in direct sunlight, in contact with fluids, or where there is excessive dust or humidity.
- Be sure the air vents on the UPS are not blocked. Allow adequate space for proper ventilation.
- The battery typically lasts for two to five years. Environmental factors impact battery life. Elevated ambient temperatures, poor quality utility power, and frequent short duration discharges will shorten battery life.
- Connect the UPS power cable directly to a wall outlet. Do not use surge protectors or extension cords.

Inventory

All models

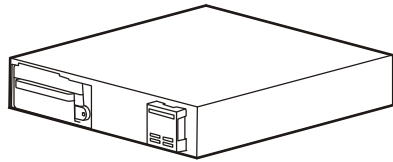

(1)

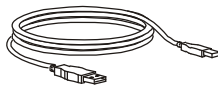

(1)



(4)

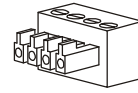

(1)

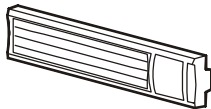

(1)

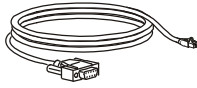

(1)



(4)



(2)



(2)

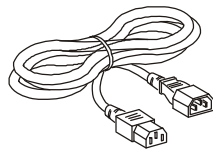

(2)

230 Vac models



(1 pair)

Rack-Mount brackets



(4)

750/1000 VA models



(2)

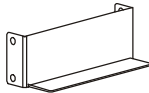

(2)



(4)



(2)

1500 VA models

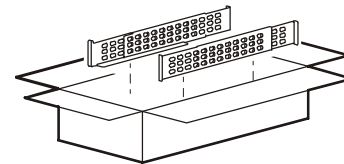

(1 pair)

Models with preinstalled network cards

Installation

Connect the battery

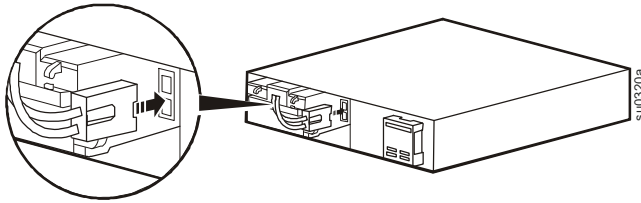

Tower to rack-mount conversion 750/1000 VA

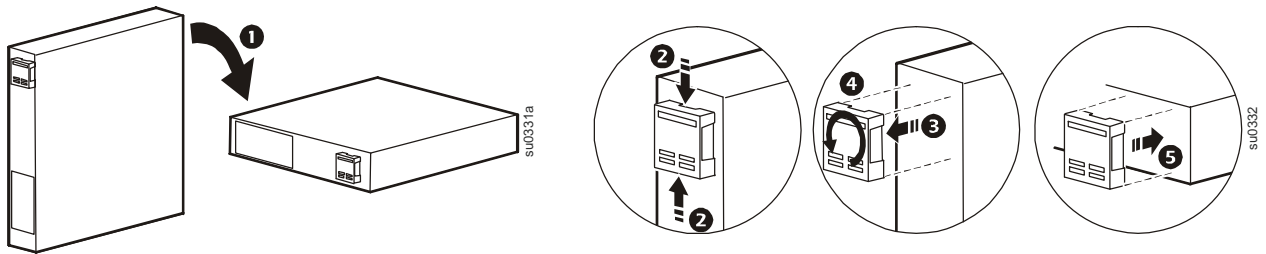

Rack-mount to tower conversion 1500 VA

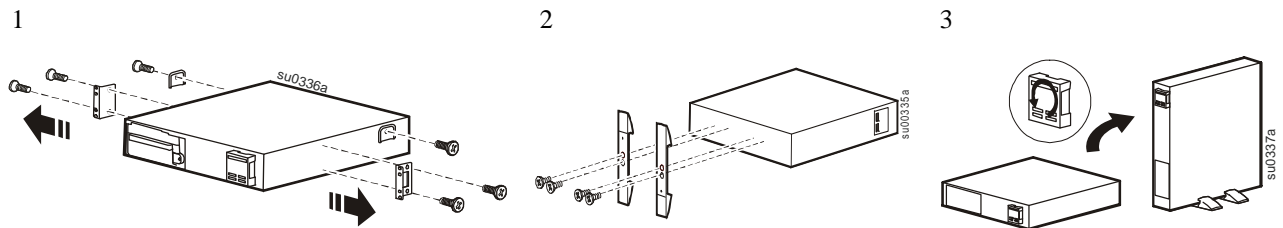

Two post rack

Front mount installation 750/1000 VA

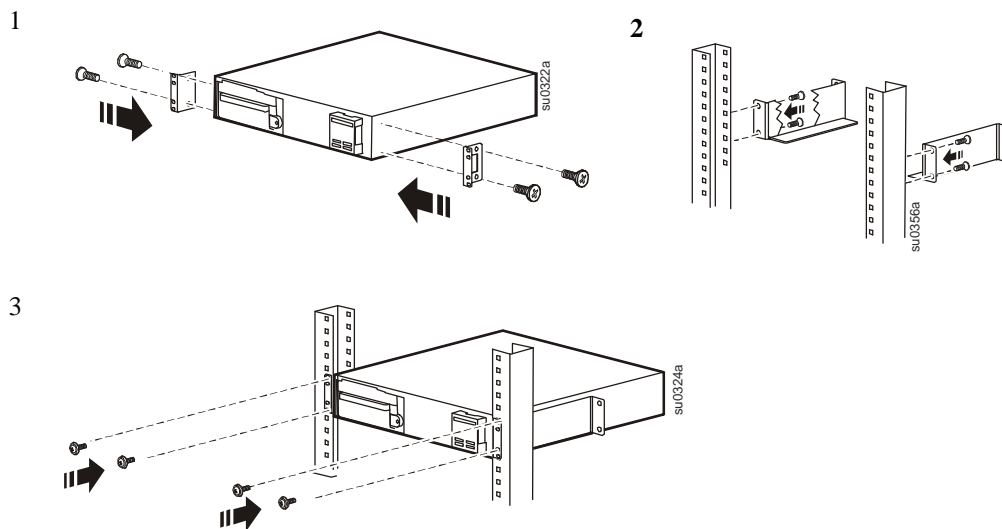

Center mount 750/1000/1500 VA

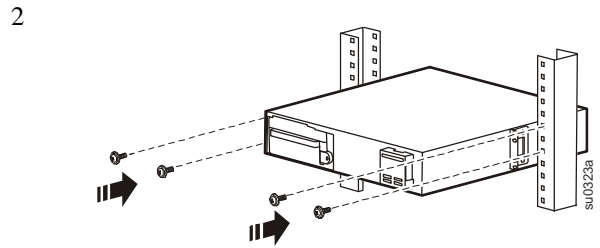
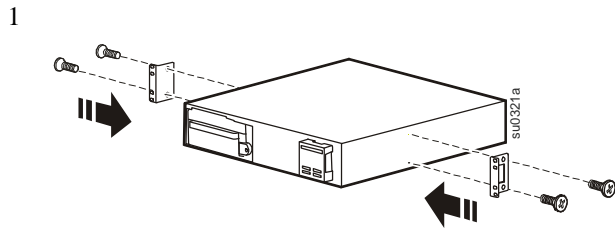

Four post rack installation 1500 VA

Use the APC Four Post Rail Kit (included with 1500 VA models only.)

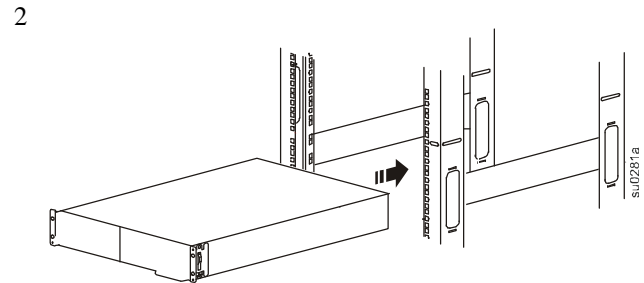
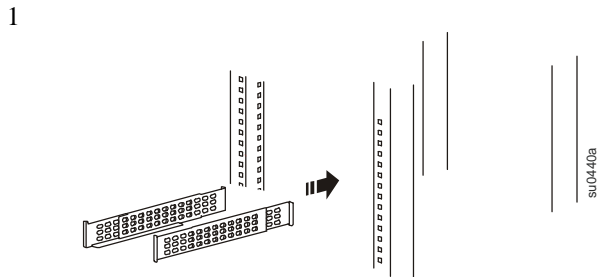

Install the bezel and rotate the logo

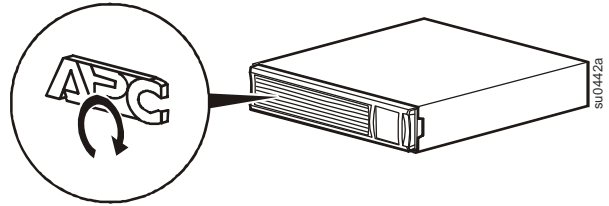
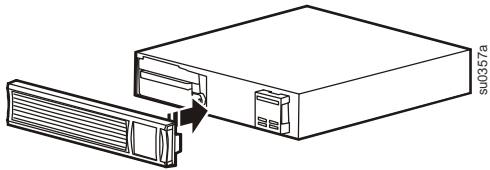

Start Up and Configuration

Overview

120 Vac

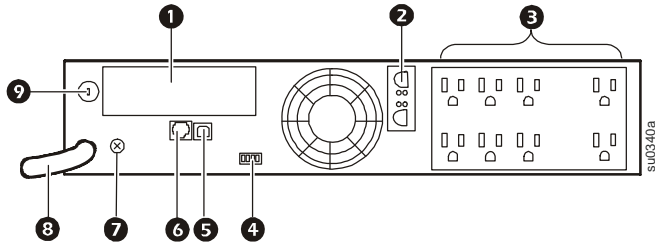

- 1 SmartSlot
- 2 External battery pack connector
- 3 Outlets
- 4 EPO connector
- 5 USB port
- 6 Serial port
- 7 Chassis ground screw
- 8 UPS input

230 Vac

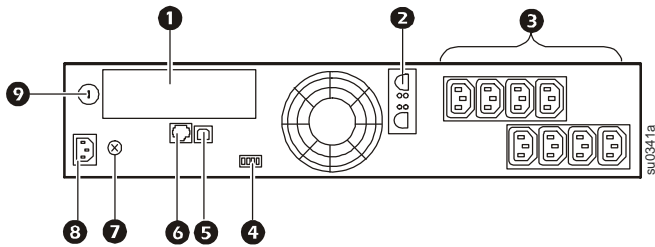

- 9 Circuit breaker

Controllable outlet groups

The outlets on the UPS are configured into groups. To configure the controlled outlet features, navigate to: **Main Menu > Control > Outlet1 Control**.

SKU	Controllable Outlet Group
750 VA	1
1000 VA	1 & 2
1500 VA	1, 2, & 3

Examples of switched outlet groups

230 V 1500 VA

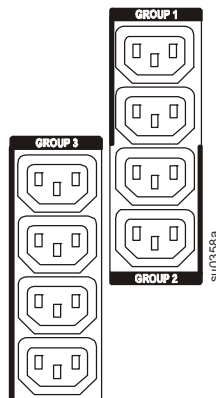

120 V 1500 VA

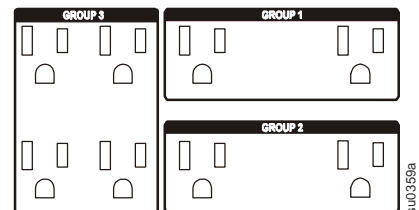

Electrical connections

CAUTION

RISK OF EQUIPMENT DAMAGE

- Adhere to all local and national electrical codes.
- Wiring should be performed by qualified electrician.
- Always connect the UPS to a grounded outlet.

Failure to follow these instructions can result in equipment damage

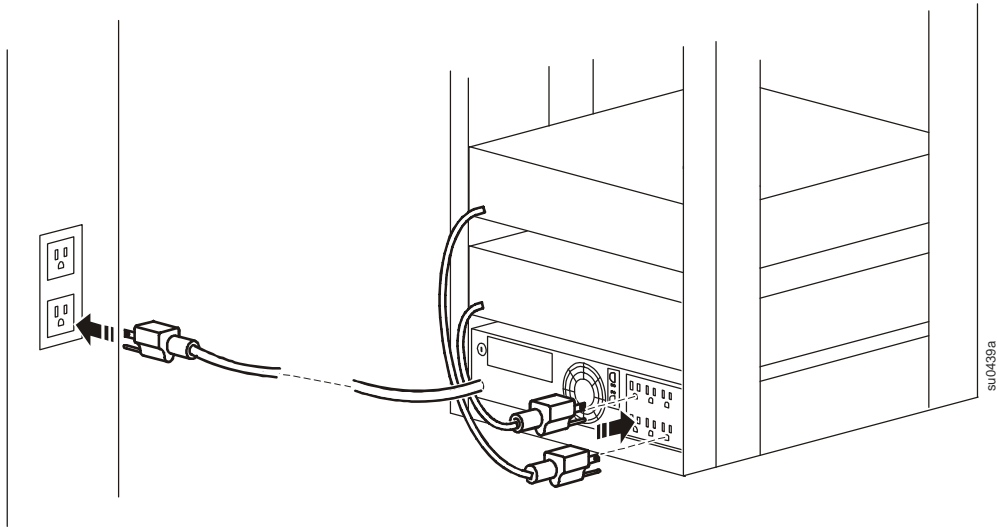

Display Interface

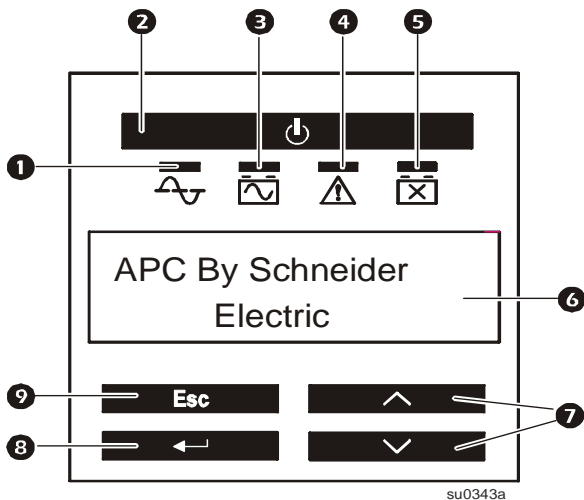

- 1 **Online LED**
- 2 **UPS ON/OFF key**
- 3 **On Battery LED**
- 4 **Site Wiring Fault LED**
- 5 **Replace Battery LED**
- 6 **Display interface**
- 7 **UP/DOWN arrow keys**
- 8 **ENTER key**
- 9 **ESC key**



Select models are ENERGY STAR[®] qualified.

For more information go to www.apc.com/site/recycle/index.cfm/energy-efficiency/energy-star/