

PA762

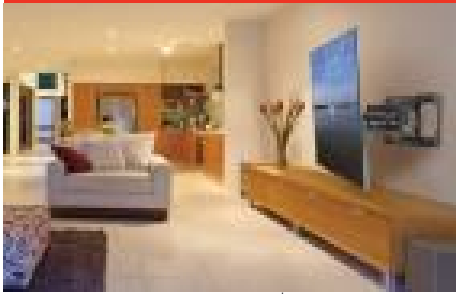

Mounting Pattern
600 x 400mm
(23.62" x 15.75")



Max Load
150lb
(68kg)

PARAMOUNT™ Articulating Wall Mount

FOR 39" TO 90" DISPLAYS*

The Paramount™ series wall mounts provide versatile and multi-functional features. With PA762, extend the display up to 21.32" (542mm) or fully-retract it to just 3.00" (76mm) from the wall for the perfect viewing angle. The Hook-and-Hang™ system offers easy, one-person installation of the display. A ratcheting handle provides locking tilt capability for quick adjustments to the amount of tilt, reducing glare and optimizing the viewing angle. Integrated cable management protects, contains and conceals cables for a clean installation.

- Universal mount accommodates 200 x 100 to 600 x 400mm VESA® mounting patterns
- Extends 21.32" (542mm) from the wall
- Retracts to 3.00" (76mm) to save space
- +15/-5° of tilt for optimal viewing angles
- Up to ±90° of pivot allows for perfect display positioning
- ±5° of roll for post installation display leveling
- Includes all necessary wall and display attachment hardware
- Design is UL listed and tested to four times stated load capacity

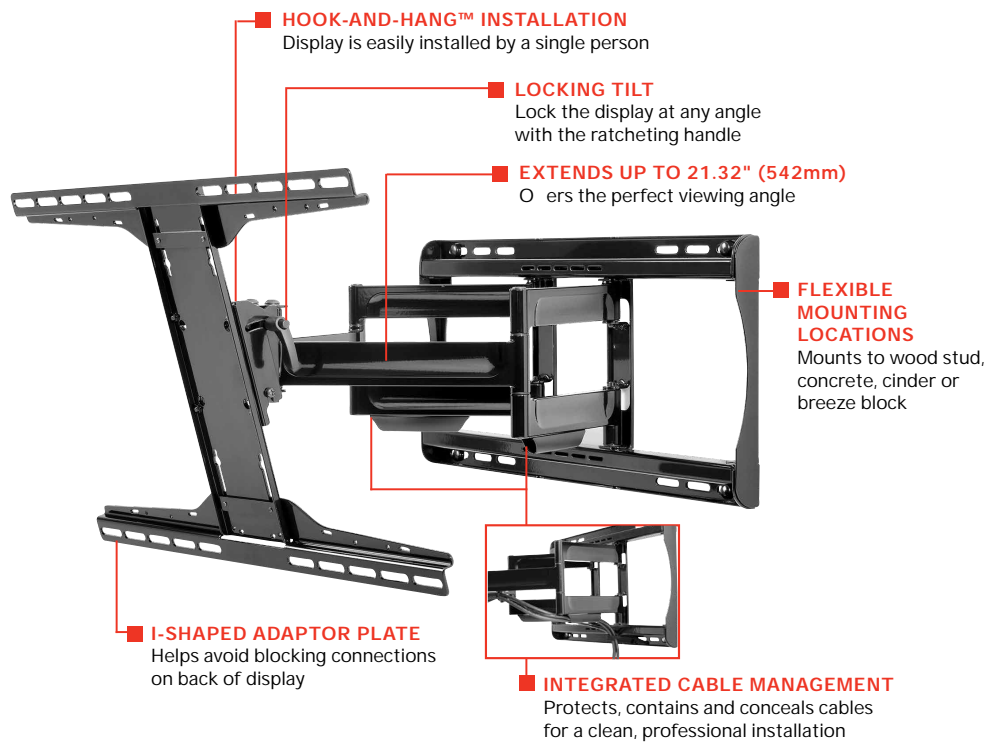

Please visit peerless-av.com/en-us/patents for patent information.



Swivel, tilt, extend or retract the display for the perfect viewing angle.



Comes in color packaging with included installation hardware and easy to follow instructions.

*This display size range is simply a guideline for product selection. Displays larger than the screen size range may still be compatible as long as they fall within the VESA® pattern and max weight of the Peerless-AV® product.

PA762 Paramount™ Articulating Wall Mount for 39" to 90" Displays

Product Specifications

| | DIMENSIONS (W x H x D) | PRODUCT WEIGHT | LOAD CAPACITY | FINISH | AVAILABLE COLORS |
|-------|--|------------------|---------------|-------------------------------|------------------|
| PA762 | 24.38" x 16.75" x 3.00"-21.32" (619 x 425 x 76-542mm) | 21.08lb (9.56kg) | 150lb (68kg) | Scratch Resistant Fused Epoxy | Gloss Black |

Package Specifications

| | PACKAGE SIZE (W x H x D) | PACKAGE SHIP WEIGHT | PACKAGE UPC CODE | PACKAGE CONTENTS | UNITS IN PACKAGE |
|-------|---|---------------------|------------------|---|------------------|
| PA762 | 27.31" x 3.50" x 16.50" (694 x 89 x 419mm) | 24.40lb (11.07kg) | 735029304890 | Wall Mount, Wall and Display Installation Hardware, Installation Instructions | 1 |

Accessories

- ACC-UCM: Universal AV Component Mount
- ESHV models: AV Wall Shelves
- WSP756: Metal Stud Wall Plate

All dimensions = inch (mm)

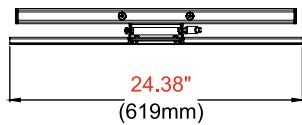

TOP VIEW

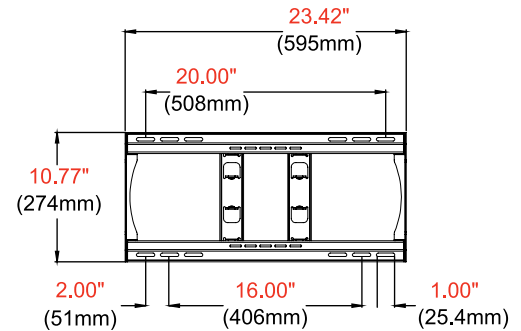

WALL PLATE DETAIL

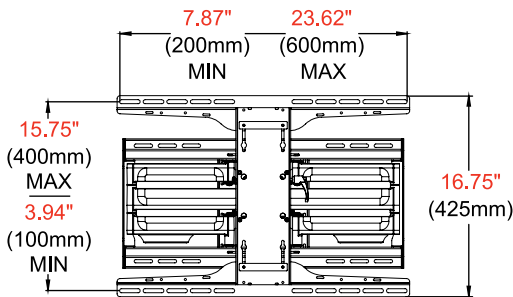

FRONT VIEW

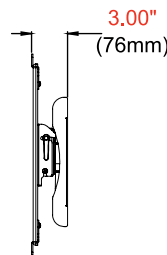

SIDE VIEW COLLAPSED

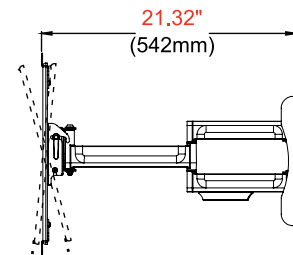

SIDE VIEW EXTENDED +15°/-5 TILT

Architect Specifications

The Paramount™ Articulating Wall Mount shall be a Peerless-AV model PA762 and shall be located where indicated on the plans. Assembly and installation shall be done according to instructions provided by the manufacturer.

Visit peerless-av.com to see the complete line of AV solutions from Peerless-AV, including outdoor displays, kiosks, digital audio, display mounts, projector mounts, carts/stands, and a full assortment of accessories.

Peerless-AV
2300 White Oak Circle
Aurora, IL 60502 USA
(800) 865-2112
(630) 375-5100
Fax: (800) 359-6500

Peerless-AV EMEA
Unit 3 Watford Interchange
Colonial Way, Watford
Herts, WD24 4WP
United Kingdom
+44 (0) 1923 200100
Fax: +44 (0) 1923 200101

Peerless-AV Latin America
Av. de las Industrias 413
Parque Industrial Escobedo
General Escobedo, N.L.,
México, 66062
+52 (81) 8384-8300
Fax: +52 (81) 8384-8360

