



# BT7824

## EXTERNAL POLE JOINER FOR Ø50mm POLES INSTALLATION GUIDE & PARTS LIST

This Pack Contains 1 Pole Joiner

PLEASE KEEP THIS FOR FUTURE REFERENCE

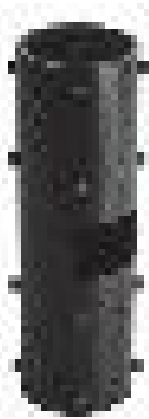

### FEATURES

- Allows a rigid join of 2 x 50mm poles
- Heavy duty steel supports substantial loads
- Allows cables to pass through poles and joiner
- Allows cable access mid-pole
- Supplied with safety bolts for secure install
- The angle of the joined pole can be micro-adjusted using the grub screws provided

*Poles sold separately*

### CONTENTS

Installation Safety Notes.....	2
Parts List.....	4
Installation Instructions.....	5
Typical Installations.....	7
Product Dimensions.....	7
B-Tech Contact Details.....	8

### INSTALLATION TOOLS REQUIRED

4mm and 5mm Hex Key  
(supplied)

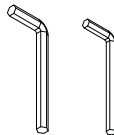

**B-TECH AUDIO VIDEO MOUNTS**

[www.btechavmounts.com](http://www.btechavmounts.com)

# INSTALLATION SAFETY INSTRUCTIONS



**CAUTION:** This pole joiner is intended for use only with the maximum weights indicated.

**Use with AV equipment heavier than the maximum indicated may result in instability causing possible injury.**

Do not attempt to install this product until all instructions and warnings have been read and properly understood. Please keep these instructions for future reference.

B-Tech International Limited, its distributors and dealers are not liable or responsible for damage or injury caused by improper installation, improper use or failure to observe these safety instructions. In such cases, all guarantees will expire.

## **General**

Great care must always be taken during installation as most AV equipment is of a fragile nature, possibly heavy and easily damaged if dropped.

If you do not fully understand the instructions or are not sure how to install this product safely, then please consult a professional for advice and/or to install this product for you. Failure to mount this product correctly may cause serious injury or death both during installation and at any time thereafter.

Do not mount any AV equipment that exceeds the specific weight limit of the product you are installing. This weight limit will be clearly stated on each product and its packaging and will vary from product to product.

## **Product location**

Please pay careful attention to where this product is located. Some locations are not suitable for installation.

If located in a public or frequently populated area ensure that the product is out of the immediate reach of people.

## **Fixing hardware**

It is highly recommended that all fixing screws be used where supplied and that the purpose of all other fixing hardware is fully understood. In some cases more AV equipment fixing hardware will be supplied to accommodate different models of equipment and set up configurations.

The installer must be satisfied that any supplied fixing hardware is suitable for each specific installation. If any fixing screws or included hardware are deemed not sufficient for a safe installation then please consult a professional or your local hardware store.

## **Hazard limitation**

When routing cables take advantage of any built in cable management features that the product might provide and ensure that all cables are tidy and secure. Check to see that any moving aspect of the product can do so unhindered by any cabling.

Some products have moving parts and the potential to cause injury through the crushing or trapping of fingers or other body parts.

Particular attention to the nature of moving parts is required especially when assembling installing and adjusting during set up.

Immediately after installations double-check that the work done is safe and secure. Double-check all necessary fixings are present and are of ample tightness.

It is recommended that periodic inspections of the product and its fixing points are made as frequently as possible to ensure that safety is maintained. If in doubt consult a professional AV installer or other suitably qualified person.

CS

Společnost B-Tech International Ltd. doporučuje provést instalaci tohoto produktu prostřednictvím odborného instalátora AV či jinak způsobilé osoby. Společnost B-Tech International Ltd, její distributoři a prodejci nenesou odpovědnost za škody nebo zranění způsobená nevhodnou instalací. Tento výrobek je nutno umístit do vhodné konstrukce a používat jen po uvedené maximální výšce.

DE

B-Tech International Ltd. empfiehlt, dass dieses Produkt durch einen qualifizierten AV-Techniker oder eine andere Person mit geeigneter Qualifikation installiert wird. B-Tech International Ltd, ihre Distributoren und Händler können nicht für durch fehlerhafte Montage verursachte Beschädigung oder Verletzung haftbar bzw. verantwortlich gemacht werden. Dieses Produkt muss auf eine geeignetem Untergrund montiert werden und darf nur bis zum angegebenen Höchstgewicht verwendet werden.

ES

B-Tech International Ltd. recomienda que un instalador de audio y video profesional u otra persona debidamente cualificada instalen este producto. B-Tech International Ltd, sus distribuidores y concesionarios no se hacen cargo ni se responsabilizan de ningún daño o lesión provocados por una instalación inapropiada. Este producto se debe montar en una estructura adecuada y se debe utilizar soportando solamente hasta el peso máximo indicado.

FR

B-Tech International Ltd. recommande de confier l'installation de ce produit à un installateur AV professionnel ou à une autre personne dûment qualifiée. B-Tech International Ltd, ses distributeurs et ses revendeurs ne sauraient être tenus responsables de tout dégât ou de toute blessure résultant d'une installation incorrecte. Ce produit doit être monté sur un support approprié et utilisé dans la limite du poids maximum indiqué.

IT

B-Tech International Ltd. consiglia di affidare l'installazione di questo prodotto a un installatore specializzato o ad altra persona adeguatamente qualificata. B-Tech International Ltd, i suoi distributori e rivenditori non accettano alcuna responsabilità nei riguardi di eventuali danni o infortuni causati da un'errata installazione. Questo prodotto deve essere fissato a una struttura idonea e utilizzato unicamente sino al peso massimo indicato.

NL

B-Tech International Ltd. adviseert om dit product te laten installeren door een professionele AV-instalateur of andere hiervoor gekwalificeerde persoon. B-Tech International Ltd, haar distributeurs en dealers zijn niet aansprakelijk of verantwoordelijk voor schade of letsel die is veroorzaakt door onoordeelkundige installatie. Dit product moet worden gemonteerd aan een geschikte constructie, waarbij het aangegeven maximum gewicht niet mag worden overschreden.

PL

Firma B-Tech International Ltd. zaleca, aby ten produkt był instalowany przez profesjonalnych instalatorów AV lub inny odpowiednio przeszkolony personel. Firma B-Tech International Ltd, jej dystrybutorzy i dealerzy nie ponoszą odpowiedzialności za uszkodzenia lub obrażenia ciała powstałe w wyniku nieprawidłowej instalacji. Niniejszy produkt musi być zamontowany na odpowiedniej powierzchni, a podczas użytkowania nie wolno przekraczać podanego maksymalnego obciążenia.

PT

A B-Tech International Ltd. recomenda que a instalação deste produto seja efectuada por um instalador de AV profissional ou outra pessoa devidamente habilitada. A B-Tech International Ltd. e os seus distribuidores e concessionários não são responsáveis por danos ou lesões causados por uma instalação incorrecta. Este produto tem de ser montado numa estrutura adequada e utilizado somente até ao peso máximo indicado.

RU

Компания B-Tech International Ltd. рекомендует, чтобы установка данного изделия производилась инженером по установке аудио-видеотехники или другим специалистом с соответствующей квалификацией. Компания B-Tech International Ltd., ее дистрибьюторы и дилеры не несут ответственности за повреждения или травмы, полученные в результате неправильной установки. Данное изделие должно

توصي بي-تيك للتجارة الدولية المحدودة بأن شخص محترف في تركيب ال AV او شخص مؤهل تأهيلا مناسباً لتركيب هذا المنتج. بي-تيك للتجارة الدولية، موزعيها والتجار ليست عرضة أو مسؤولة عن الأضرار أو الإصابات الناجمة عن تركيب غير سليم، والاستخدام غير السليم أو عدم مراعاة هذه التعليمات للسلامة. يجب أن يتم تركيب هذا المنتج في بنية مناسبة ويجب استخدام فقط لدعم الحد الأقصى للوزن المشار إليه.

# BT7824 PARTS LIST

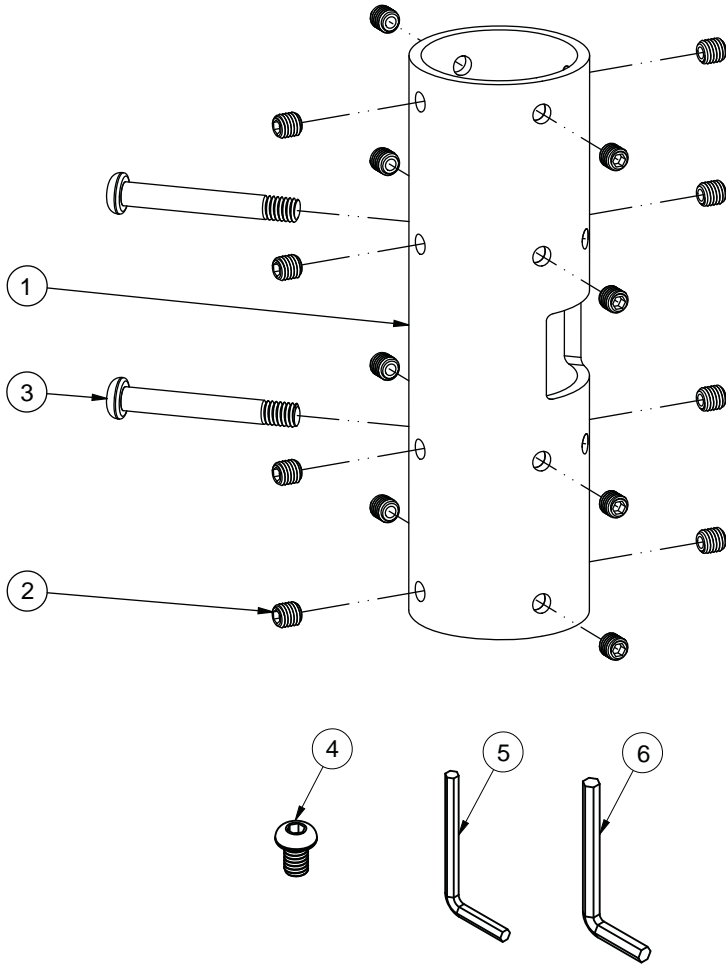

REF	PART NAME	QTY
1	Ø50mm POLE JOINER	1
2	M8 x 8mm GRUB SCREW	16
3	M8 x 60mm SCREW	2
4	M8 x 12mm SCREW	2
5	4mm HEX KEY	1
6	5mm HEX KEY	1

PLEASE KEEP THIS FOR FUTURE REFERENCE

# INSTALLATION INSTRUCTIONS

1

## Attach Pole Joiner to Pole

Insert the BT7850 Ø50mm pole (sold separately) into the external pole joiner (part 1) and line up the screw hole with the hole in the pole.

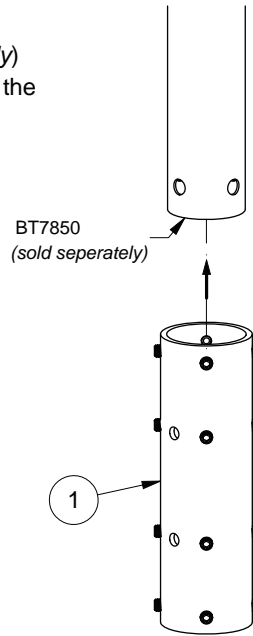

2

## Secure Pole Joiner

Insert the M8 x 60mm (part 3) screw or the M8 x 12mm screw (part 4) and tighten using the 5mm hex key (part 6).

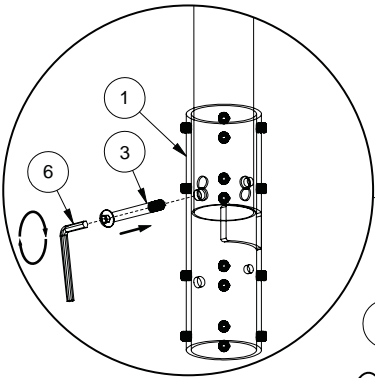

### WARNING

Ensure the M8 x 60mm screws (part 3) are in place before any AV equipment is fitted

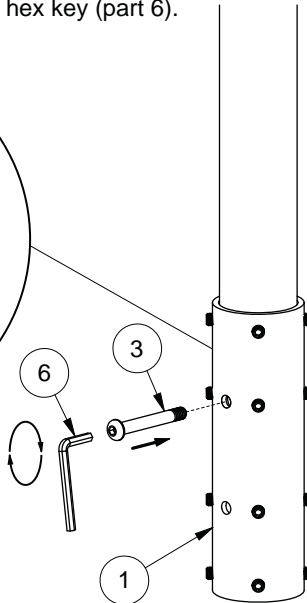

### OPTIONAL

M8 x 60mm screw (part 3) can be replaced with the M8 x 12mm screw (part 4) to prevent cables being obstructed.

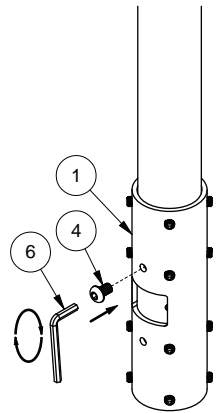

### WARNING

Ensure the M8 x 12mm screws (part 4) are in place before any AV equipment is fitted

### 3

#### Connect Poles

Insert another BT7850 Ø50mm pole (*sold separately*) into the external pole joiner (part 1) and line up the screw hole with the hole in the pole.

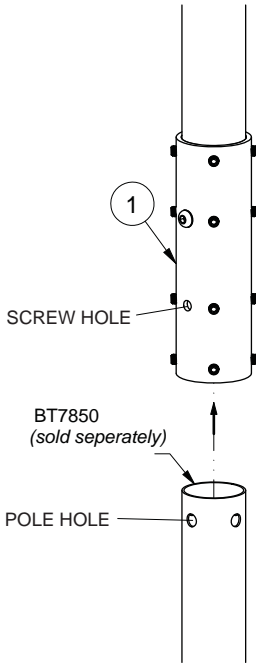

### 4

#### Insert Safety Bolt

Insert the M8 x 60mm screw (part 3) or the M8 x 12mm screw (part 4) and tighten using the 5mm hex key (part 6).

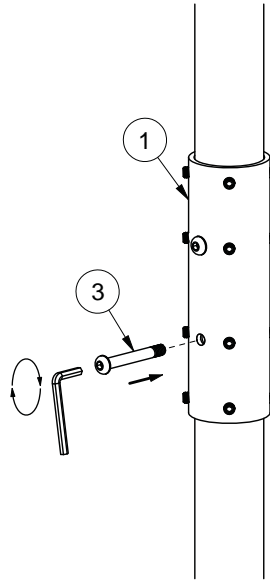

**WARNING**  
Ensure the M8 x 60mm screws (part 3) are in place before any AV equipment is fitted

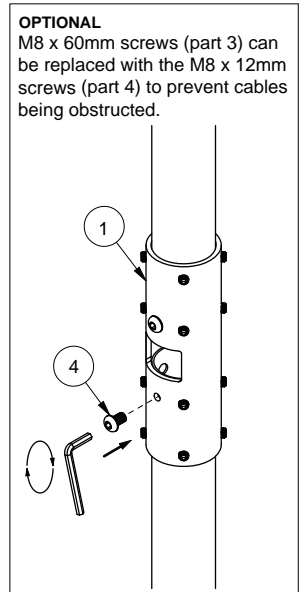

**OPTIONAL**  
M8 x 60mm screws (part 3) can be replaced with the M8 x 12mm screws (part 4) to prevent cables being obstructed.

**WARNING**  
Ensure the M8 x 12mm screws (part 4) are in place before any AV equipment is fitted

### 5

#### Secure Pole Joiner

Tighten the M8 x 8mm grub screws (part 2) onto both poles using the 4mm hex key (part 5).

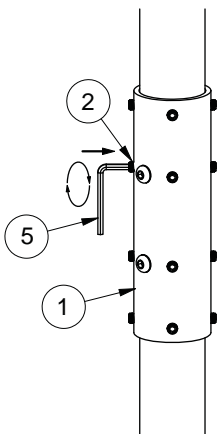

**NOTE:** The angle of the poles can be adjusted using the grub screws (part 2) provided and the 4mm hex key (part 5).

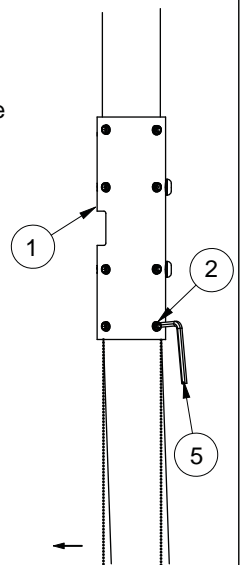

# TYPICAL INSTALLATIONS

## Ceiling mounted

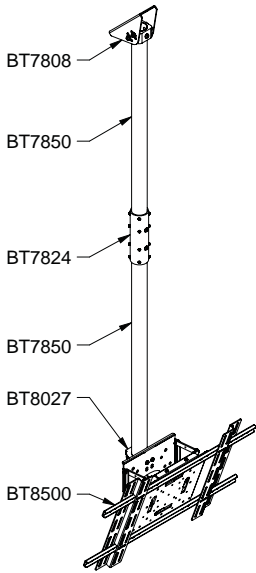

## Floor to ceiling mounted

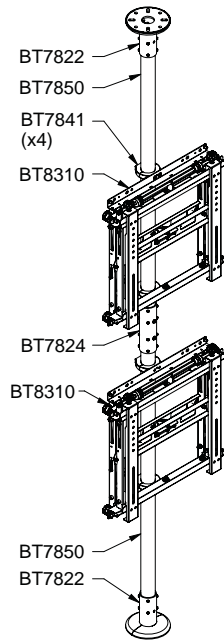

# BT7824 PRODUCT DIMENSIONS

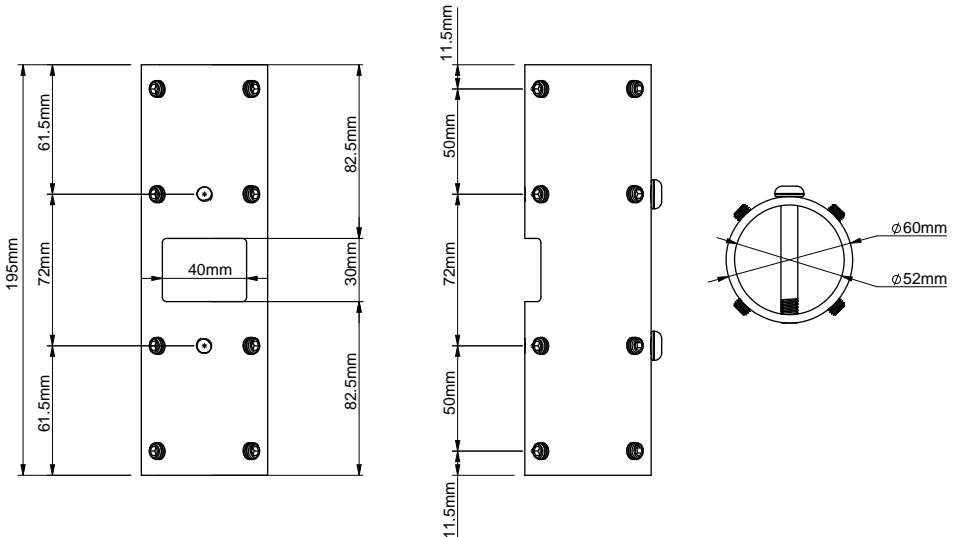

THESE INSTRUCTIONS ARE INTENDED AS A GUIDE ONLY AND B-TECH ACCEPTS NO LIABILITY FOR THE ACCURACY OF THE INFORMATION CONTAINED IN THIS DOCUMENT.

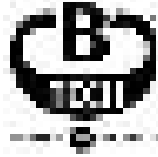

[www.btechavmounts.com](http://www.btechavmounts.com)

## **B-TECH AUDIO VIDEO MOUNTS**

### **HEAD OFFICE**

#### **B-Tech International Limited**

Bennett House, Long March, Daventry, Northants., NN11 4NR, UK

Email: [info@btechavmounts.com](mailto:info@btechavmounts.com)

©2015 B-Tech International Limited. All rights reserved.

B-Tech Audio Video Mounts is a division of B-Tech International Limited.

B-Tech, Better By Design, System 2 and Pro Install are registered trademarks of B-Tech International Limited.

All other brands and product names are trademarks of their respective owners.

Photographs are for illustrative purposes only. E&OE.