



TC-20M TC-20
Online Manual

Contents

Symbols Used in This Document.	20
Touch-enabled Device Users (Windows).	21
Printing Online Manual.	22
Trademarks and Licenses.	23
Trademarks.	24
Licenses.	25
Overview.	45
Printer Parts.	46
Front.	47
Back / Side.	50
Top View.	51
Inside.	53
Operation Panel.	55
Desktop Basket.	57
Printer Stand.	59
Using the Printer.	61
Turning the Printer On and Off.	62
Using the Desktop Basket.	64
Using the Basket on the Printer Stand.	66
Stopping Printing.	68
Loading Originals on Document Platen.	69
Loading Originals Correctly for each Function.	71
Printing.	74
Printing from Your Computer (Windows).	76
Printing with Easy Setup.	77
Setting the Number of Copies and Printing Order.	82
Printing Photos and Business Documents.	83
Printing By Setting Print Purpose.	84
Edit in PosterArtist and Print.	87
Printing CAD Drawings.	89
Changing the Print Quality and Correcting Image Data.	90
Adjusting Color Balance.	91

Setting the Print Quality Level (Custom)	93
Printing a Color Document in Monochrome	95
Specifying Color Correction	97
Optimal Photo Printing of Image Data	100
Adjusting Colors with the Printer Driver	101
Printing with ICC Profiles	104
Adjusting Brightness	109
Adjusting Contrast	111
Printing Using Detailed Setting Mode	113
Scaled Printing	116
Printing to Oversized Paper Sizes	119
Setting Paper Dimensions (Custom Size)	121
Printing Hanging and Horizontal Banners (Large-Format Printing)	124
Printing by Dividing/Joining Documents	126
Printing by Connecting Multiple Pages	127
Printing Multiple Pages All on One Page	128
Dividing and Printing Posters	130
Printing by Saving Roll Paper	133
Saving Roll Paper by Rotating Document 90 Degrees	134
Switching the Paper Source to Match the Purpose	137
Displaying the Print Results before Printing	139
Other Convenient Settings	140
Stamp Printing	141
Registering a Stamp	142
Setting a Page Size and Orientation	145
Registering a Frequently Used Printing Profile	146
Printing from Printer	148
Printing Photographs Saved on USB Flash Drive	149
Using Useful Display Functions	154
Printing Documents (PDF) Saved on USB Flash Drive	157
Printing from Smartphone/Tablet	161
Copying	162
Copying to Roll Paper	163

Copying to the Roll Width.	164
Making Enlarged Copies with Basic Settings.	166
Print a Single Original to Roll Paper Multiple Times Using a Layout.	168
Reducing/Enlarging Copies.	171
Copying Thick Originals Such as Books.	175
Copying to Cut Sheet.	177
Making Copies.	178
Setting Items for Copying.	181
Reducing/Enlarging Copies.	184
Copying Two Pages onto Single Page.	187
Copying Four Pages onto Single Page.	191
Making Image Stitch Copies.	195
Copying ID Card to Fit onto Single Page.	198
Copying Thick Originals Such as Books.	201
Scanning.	203
Saving Scanned Data to Your Computer.	204
Setting Items for Scanning Using Operation Panel.	207
Sending Scanned Data as E-Mail from Printer.	209
Sending Scanned Data as E-Mail from Printer.	210
Registering Recipients' E-Mail Address.	214
Registering Recipients in Group E-Mail.	217
Changing Registered Information.	222
Deleting Registered Information.	224
Importing/Exporting E-Mail Address Book.	225
Sending Scanned Data as E-Mail from Computer.	227
Saving Scanned Data on USB Flash Drive.	230
Forwarding Scanned Data to Shared Folder on Computer.	233
Scanning with a Computer Application.	236
Scanning in Windows.	237
Scanning According to Item Type or Purpose (IJ Scan Utility).	239
IJ Scan Utility Features.	240
Scanning Documents and Photos.	242
Creating/Editing PDF Files.	243
Setting Passwords for PDF Files.	247

Editing Password-Protected PDF Files.	249
Scanning with Favorite Settings.	250
Scanning Originals Larger than the Platen (Image Stitch).	251
Adjusting Cropping Frames in the Image Stitch Window.	254
Scanning Multiple Originals at One Time.	255
Sending Scanned Images via E-mail.	257
Extracting Text from Scanned Images (OCR).	259
Saving after Checking Scan Results.	261
Starting IJ Scan Utility.	264
IJ Scan Utility Screens.	265
IJ Scan Utility Main Screen.	266
Settings Dialog Box.	268
Settings (General Settings) Dialog Box.	269
Settings (Scanning from a Computer) Dialog Box.	270
Settings (Scanning from the Operation Panel) Dialog Box.	277
PDF Edit Screen.	282
Scanning Using Application Software (ScanGear).	286
What Is ScanGear (Scanner Driver)?	287
Starting ScanGear (Scanner Driver).	289
Scanning in Basic Mode.	290
ScanGear (Scanner Driver) Screens.	293
Basic Mode Tab.	294
Advanced Mode Tab.	302
Input Settings.	308
Output Settings.	311
Image Settings.	314
Color Adjustment Buttons.	319
Preferences Dialog Box.	322
List of Unsupported Models (Auto Power Off).	328
General Notes (Scanner Driver).	329
Scanning in Advanced Mode.	331
Scanning Multiple Documents at One Time with ScanGear (Scanner Driver).	334
Correcting Images and Adjusting Colors with ScanGear (Scanner Driver).	338
Correcting Images (Unsharp Mask, Reduce Dust and Scratches, Fading Correction, etc.)	339

Adjusting Colors Using a Color Pattern.	343
Adjusting Saturation and Color Balance.	345
Adjusting Brightness and Contrast.	347
Adjusting Histogram.	349
Adjusting Tone Curve.	353
Setting Threshold.	356
Positioning Originals (Scanning from Computer).	357
Adjusting Cropping Frames (ScanGear).	362
Scanning Tips.	366
Positioning Originals (Scanning from Computer).	367
Network Scan Settings.	371
IJ Network Scanner Selector EX2 Menu and Setting Screen.	375
Uninstalling IJ Network Scanner Selector EX2.	378
Updating the ScanGear (Scanner Driver).	379
Obtaining the Latest ScanGear (Scanner Driver).	380
Deleting the Unnecessary ScanGear (Scanner Driver).	381
Before Installing the ScanGear (Scanner Driver).	382
Installing the ScanGear (Scanner Driver).	383
Scanning with WIA Driver.	384
Resolution.	388
Data Formats.	390
Color Matching.	391
Setting Up Operation Panel with IJ Scan Utility (Windows).	392
Printer Driver.	393
Windows Printer Driver.	394
Overview of the Printer Driver.	395
Canon IJ Printer Driver.	396
Changing the Print Options.	397
Canon imagePROGRAF Preview.	398
How to Open the Printer Driver Setup Window.	399
Updating Media Information in Printer Driver.	400
Deleting the Undesired Print Job.	401
Canon IJ Status Monitor.	402
Checking the Ink Status from Your Computer.	404

Instructions for Use (Printer Driver)	405
Printer Driver Description	408
Main Tab Description	409
Page Setup Tab Description	417
Layout Tab Description	421
Favorites Tab Description	427
Utility Tab Description	429
Device Settings Tab Description	431
Canon IJ Status Monitor Description	432
Updating the Printer Driver	435
Obtaining the Latest Printer Driver	436
Deleting the Unnecessary Printer Driver	437
Before Installing the Printer Driver	438
Installing the Printer Driver	439
Application Software	440
Handling Paper	441
Loading Rolls in the Printer	442
Moving the Roll Holder Support	451
Removing the Roll from the Printer	453
Loading Sheets in the Printer	458
Paper Settings	462
Changing the Type of Paper	463
Specifying the Ink Drying Time	465
Specifying the Cutting Method for Rolls	467
Making Margin Settings for Rolls	470
Cutting the Leading Edge of Roll Paper Automatically	473
Reducing Dust from Cutting Rolls	475
Information about Paper	477
Paper Sizes	478
Updating paper information	479
Using Paper Other Than Genuine Paper and feed confirmed Paper	480
Printing on Paper Other Than Genuine Paper and feed confirmed Paper Using Existing Settings	481

Printing on Paper Other Than Genuine Paper and feed confirmed Paper by Adding a Media Type.	482
Changing Printer's Setting.	483
Changing Settings from Operation Panel.	484
Home Screen Menu Composition.	485
Menu Structure.	489
Advanced (Paper settings).	502
Advanced (LAN settings).	504
Setting Items on Operation Panel.	506
Print settings.	508
Paper-related settings.	509
LAN settings.	510
Other printer settings.	516
Language selection.	519
Firmware update.	520
Reset settings.	521
Maintenance.	522
Web service setup.	524
ECO.	525
System information.	526
Job management.	527
Setting Administrator Password on Operation Panel.	528
Checking the Total Number of Uses of Printer.	530
Changing Printer's Setting Using Web Browser.	532
Start up Remote UI.	533
Changeable Setting Items Using Remote UI.	536
Security.	538
LAN settings.	539
Setting Passwords Using Remote UI.	541
Registering Printer's Root Certificate to Web Browser for SSL Communication.	543
Registering Printer's Root Certificate to Local Computer for SSL Communication.	547
Generating Server Certificate.	553
Setting Mail Server.	556
Specifying Mail Setting for Sending Scanned Data.	558
Receiving Printer Status by E-mail.	559

Network Setting.	561
Printer Connection Methods.	562
Wi-Fi Connection.	564
WPS Connection.	567
WPS (PIN Code) Connection.	569
Manual connect.	571
Easy wireless connect.	575
Wireless Direct Connection.	577
Wired Connection.	580
USB Connection.	584
Default Network Settings.	585
Another Printer Found with Same Name.	587
Printing Network Settings.	588
Network Status and Troubleshooting.	594
Sharing the Printer on a Network (Windows).	596
Setting Up a Shared Printer.	597
Restrictions on Printer Sharing.	599
Adjustments for Better Print Quality.	600
Checking for Nozzle Clogging.	601
Cleaning the Print Head.	604
Deep Print Head Cleaning.	607
Automatic Adjustment to Straighten Lines and Colors.	609
Manual Adjustment to Straighten Lines and Colors.	611
Automatically Adjusting Different Colored Horizontal Streaks.	615
Manually Adjusting Different Colored Horizontal Streaks.	617
Adjusting Line Length.	619
Maintenance and Consumables.	621
Replacing Consumables.	622
Refilling Ink Tanks.	623
Checking Ink Level.	628
Replacing the Print Head.	630
Checking the Remaining Maintenance Cartridge Capacity.	637

Replacing the Maintenance Cartridge.	638
Cleaning the Printer.	643
Cleaning the Printer Exterior.	644
Cleaning Inside the Printer.	645
Cleaning Document Platen and Document Cover.	649
Cleaning Paper Feed Rollers.	650
Performing Bottom Plate Cleaning.	652
Performing Maintenance Functions from Your Computer (Windows).	654
Cleaning the Print Heads.	655
Printing a Nozzle Check Pattern.	656
Other Maintenance.	658
Preparing to Transfer the Printer.	659
Reinstalling the Printer.	667
Firmware update.	671
Frequently Asked Questions.	673
Printer Does Not Print.	677
Cannot Print or Connect.	679
The printer does not respond even if print jobs are sent.	680
Printing stops and an error message is displayed.	681
Failed to Printer Driver Installation (Windows).	682
Removing Printer Software.	683
Repairing Your Printer.	685
Problems with the Printing Quality.	688
Printing is faint.	689
Banding in different colors occurs.	691
Colors in printed images are uneven.	693
Image edges are blurred or white banding occurs.	696
Paper rubs against the Print Head.	698
The edges of the paper are dirty.	700
The surface of the paper is dirty.	703
The back side of the paper is dirty.	706
Printed colors are inaccurate.	708
Documents are printed in monochrome.	710
Line thickness is not uniform.	711

Lines or colors are misaligned.	713
The length of the printed image in the paper ejection direction is not accurate.	715
Images are printed crooked.	717
Margins are wide.	718
Cannot Configure Network Settings.	719
Message Appears on Computer During Setup.	720
Cannot Proceed beyond Printer Connection Screen/Connect Cable Screen.	721
"Failed to connect to the wireless router." Appears.	723
Printer Cannot Be Used After Replacing Wireless Router or Changed Router Settings.	725
Error Occurs During Wi-Fi Setup.	727
Taking Time to Setup Process (Windows).	729
Cannot Find Printer on Network.	730
Cannot Connect Printer to Network.	731
Cannot Find Printer During Setup.	732
Cannot Find Printer while Using Wi-Fi.	736
Cannot Find Printer while Using Wired LAN.	739
Searching Printer by IP Address or Host Name During Setup.	740
Cannot Print over Network.	744
Cannot Print over TCP/IP Network.	745
Cannot Print over Bonjour networks.	746
Cannot Print Using AirPrint.	747
Network Connection Problems.	748
Network Settings and Common Problems.	749
Cannot Connect to the Printer.	750
Network Key (Password) Unknown.	755
Forgot Administrator Password of Printer.	757
Checking Network Information.	758
Restoring to Factory Defaults.	761
Cannot Access to Internet on Wi-Fi from Communication Device.	762
Printer Problems.	763
Printer Does Not Turn On.	764
USB Connection Problems.	765
Cannot Communicate with Printer via USB.	766
Touch Screen Is Off.	767
Messages advising to check the maintenance cartridge are not cleared.	768

If the Printer Makes a Strange Sound.	769
Printing Problems.	770
Copying/Printing Stops.	771
Printer Prints Slowly.	772
Paper is not Fed or Ejected Properly.	773
Remove Jammed Roll Paper.	774
Remove a Jammed Sheet.	778
Remove Jammed Paper (Paper Feed Slot).	781
Roll paper cannot be inserted into the Paper Feed Slot.	783
Printer Does Not Pick up or Feed the Paper/"No Paper" Error.	785
Roll Paper Remains/Lacks under Quantity Management.	787
The printer ejects blank, unprinted paper.	788
When printing on roll paper, the printed surface becomes scratched.	789
Paper Cutting Problems.	790
Paper is not cut straight.	791
Cutter Blade Does Not Work While Cutting Is in Progress.	792
I want to know how to configure roll cutting.	793
I want to configure so that the roll is cut automatically after waiting for the ink to dry.	794
Paper Setting Problems.	795
Cannot detect tracing paper size.	796
I want to know the paper types that can be used in this printer.	797
Media Type Selection does not Match Loaded Media Type.	798
The paper type that I want to print is not displayed on the Touch Screen.	799
Ink-related Problems.	800
Ink Does Not Come Out.	801
Printer consumes a lot of ink.	802
Ink Level Detection.	803
About Print Settings.	804
How do I print without borders.	805
I want to easily create vertical or horizontal banners.	806
Can I perform duplex printing.	807
I want to perform enlargement printing.	808
Scanning Problems (Windows).	809
Scanning Problems.	810

Scanner Does Not Work.	811
ScanGear (Scanner Driver) Does Not Start.	812
Error Message Appears and the ScanGear (Scanner Driver) Screen Does Not Appear.	813
Cannot Scan Multiple Originals at One Time.	814
Cannot Scan Properly with Auto Scan.	815
Slow Scanning Speed.	816
"There is not enough memory." Message Is Displayed.	817
Computer Stops Operating during Scanning.	818
Scanner Does Not Work after Upgrading Windows.	819
Scanned Image Does Not Open.	820
Scan Results Are Unsatisfactory.	821
Moire Appears in Scan Results.	822
Scan Quality (Image Displayed on the Monitor) Is Poor.	823
Scanned Image Is Surrounded by Extra White Areas.	825
Cannot Scan at the Correct Size.	826
Position or Size of the Image Cannot be Detected Correctly When Scanning from the Operation Panel.	827
Original Is Placed Correctly, but the Scanned Image Is Slanted.	828
Scanned Image Is Enlarged (Reduced) on the Computer Monitor.	829
Unwanted Streaks Appear in Scan Results after Scanning from ADF (Auto Document Feeder).	830
Software Problems.	831
The E-mail Client You Want to Use Does Not Appear in IJ Scan Utility's Selection Screen.	832
IJ Scan Utility Error Messages.	833
ScanGear (Scanner Driver) Error Messages.	835

List of Support Code for Error. 838

1000.	840
100A.	841
1021.	842
1024.	843
1026.	844
1058.	845
1070.	846
1200.	847
1201.	848
120A.	849

120B.....	850
1215.....	851
1220.....	852
1221.....	853
1300.....	854
1313.....	856
1317.....	857
1369.....	858
136A.....	859
136B.....	860
1401.....	861
1403.....	862
1405.....	863
140B.....	864
1434.....	865
147D.....	866
1496.....	867
1563.....	868
15A1.....	869
15A2.....	870
15A3.....	871
15B0.....	872
1643.....	873
1723.....	874
1724.....	875
1725.....	876
1726.....	877
1727.....	878
2001.....	879
2002.....	880
2114.....	881
2117.....	883
2123.....	885

2200.....	886
2500.....	887
2700.....	888
3000.....	889
3252.....	890
3306.....	891
3310.....	892
3311.....	893
3312.....	894
3313.....	895
3314.....	896
3315.....	897
3316.....	898
3317.....	899
3318.....	900
3319.....	901
3401.....	902
3405.....	903
3407.....	904
3408.....	905
3412.....	906
3413.....	907
3414.....	908
3415.....	909
3416.....	910
3417.....	911
3418.....	912
3419.....	913
3420.....	914
3421.....	915
3422.....	916
3423.....	917
3424.....	918

3425.....	919
3438.....	920
3440.....	921
3441.....	922
3442.....	923
3443.....	924
3444.....	925
3445.....	926
3446.....	927
3447.....	928
4103.....	929
4104.....	930
4111.....	931
4920.....	932
4931.....	933
495A.....	934
5011.....	935
5012.....	936
5050.....	937
5100.....	938
5108.....	939
5200.....	940
5207.....	941
5700.....	942
5C02.....	943
5C30.....	944
6000.....	945
6001.....	946
6004.....	947
6011.....	948
6012.....	949
6013.....	950
6014.....	951

6015.....	952
6016.....	953
6017.....	954
6018.....	955
6019.....	956
6030.....	957
6500.....	958
6503.....	959
6700.....	960
6701.....	961
6800.....	962
6801.....	963
6830.....	964
6831.....	965
6832.....	966
6833.....	967
6900.....	968
6901.....	969
6902.....	970
6910.....	971
6920.....	972
6921.....	973
6930.....	974
6931.....	975
6932.....	976
6933.....	977
6936.....	978
6937.....	979
6938.....	980
6940.....	981
6941.....	982
6942.....	983
6943.....	984

6944.....	985
6945.....	986
6946.....	987
6A80.....	988
6A81.....	989
6D01.....	990
7500.....	991
7600.....	992
7700.....	993
7800.....	994
8200.....	995
9000.....	996
B506.....	997
B508.....	998
B509.....	999
B50A.....	1000
C000.....	1001
D103.....	1002
D107.....	1003
D108.....	1004
D109.....	1005
Specifications.....	1006
Specifications.....	1007
Print Area.....	1012
Appendix.....	1014
Safety.....	1015
Safety Precautions.....	1016
Regulatory Information.....	1020
WEEE.....	1022
Handling Precautions.....	1036
When Repairing, Lending, or Disposing of the Printer.....	1037
Legal Restrictions on Scanning/Copying.....	1038

Ink Tips.	1039
Online Manual.	1040

Symbols Used in This Document

Warning

Instructions that, if ignored, could result in death, serious personal injury, or property damage caused by incorrect operation of the equipment. These must be observed for safe operation.

Caution

Instructions that, if ignored, could result in personal injury or property damage caused by incorrect operation of the equipment. These must be observed for safe operation.

Important

Instructions including important information that must be observed to avoid damage and injury or improper use of the product. Be sure to read these instructions.

Note

Instructions including notes for operation and additional explanations.

Basics

Instructions explaining basic operations of your product.

Note

- Icons may vary depending on your product.

Touch-enabled Device Users (Windows)

For touch actions, you need to replace "right-click" in this document with the action set on the operating system. For example, if the action is set to "press and hold" on your operating system, replace "right-click" with "press and hold."

Printing Online Manual

To print the Online Manual, use the print function of your Web browser.

For Windows:

To set to print background colors and images, follow the steps below.

▶▶▶ Note

- If you are using Windows 8.1, print in the desktop version.
- Background colors and background images cannot be printed in Microsoft Edge. To print background colors and background images, use Internet Explorer 11, Mozilla Firefox, or Google Chrome.

• In Internet Explorer 11

1. Select  (Tools) > **Print** > **Page setup....**
2. Select the **Print Background Colors and Images** checkbox.

• In Mozilla Firefox

1. Select  (Menu) > **Print... > Page Setup....**
2. Select the **Print Background (colors & images)** checkbox in **Format & Options**.

• In Google Chrome

1. Select  (Customize and control Google Chrome) > **Print....**
2. Click **More settings**, and then select the **Background graphics** checkbox in **Options**.

For macOS:

To print background colors and images, follow the steps below to display the Print dialog options, then select the **Print backgrounds** checkbox.

1. Click **Print...** from the **File** menu.
2. Click **Show Details**.
3. Select **Safari** from the pop-up menu.

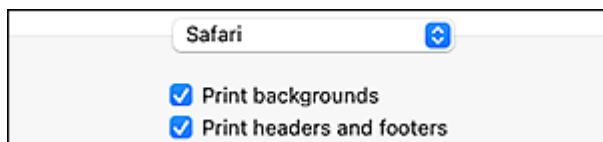

Trademarks and Licenses

- ▶ Trademarks
- ▶ Licenses

Trademarks

- Microsoft is a registered trademark of Microsoft Corporation.
- Windows is a trademark or registered trademark of Microsoft Corporation in the U.S. and/or other countries.
- Windows Vista is a trademark or registered trademark of Microsoft Corporation in the U.S. and/or other countries.
- Microsoft Edge and Microsoft Excel are either trademarks or registered trademarks of Microsoft Corporation in the U.S. and/or other countries.
- Internet Explorer is a trademark or registered trademark of Microsoft Corporation in the U.S. and/or other countries.
- Mac, Mac OS, macOS, OS X, AirPort, App Store, AirPrint, the AirPrint logo, Safari, Bonjour, iPad, iPad Air, iPad mini, iPadOS, iPhone and iPod touch are trademarks of Apple Inc., registered in the U.S. and other countries.
- IOS is a trademark or registered trademark of Cisco in the U.S. and other countries and is used under license.
- Google Cloud Print, Google Chrome, Chrome OS, Chromebook, Android, Google Drive, Google Apps and Google Analytics are either registered trademarks or trademarks of Google Inc. Google Play and Google Play Logo are trademarks of Google LLC.
- Adobe, Acrobat, Flash, Photoshop, Illustrator, Adobe RGB and Adobe RGB (1998) are either registered trademarks or trademarks of Adobe Systems Incorporated in the United States and/or other countries.
- Adobe, Acrobat, Flash, Photoshop, Photoshop Elements, Lightroom, Adobe RGB and Adobe RGB (1998) are either registered trademarks or trademarks of Adobe Systems Incorporated in the United States and/or other countries.
- Google, Google Home, and Android are trademarks of Google LLC.
- LINE Clova is a registered trademark of LINE Corporation.
- App Store is a trademark of Apple Inc., registered in the U.S. and other countries.
- Bluetooth is a trademark of Bluetooth SIG, Inc., U.S.A. and licensed to Canon Inc.
- Autodesk and AutoCAD are registered trademarks or trademarks of Autodesk, Inc., and/or its subsidiaries and/or affiliates in the USA and/or other countries.
- QR Code is a registered trademark of DENSO WAVE INCORPORATED in Japan and in other countries.
- The Mopria® word mark and the Mopria® Logo are registered and/or unregistered trademarks of Mopria Alliance, Inc. in the United States and other countries. Unauthorized use is strictly prohibited.
- HP-GL and HP-GL/2 are either registered trademarks or trademarks of HP Inc. in the United States and/or other countries.
- All other company names and products mentioned in this guide may be registered trademarks or trademarks of their respective companies.

▶▶▶ Note

- The formal name of Windows Vista is Microsoft Windows Vista operating system.

Licenses

Copyright (c) 2003-2015 Apple Inc. All rights reserved.

Redistribution and use in source and binary forms, with or without modification, are permitted provided that the following conditions are met:

1. Redistributions of source code must retain the above copyright notice, this list of conditions and the following disclaimer.
2. Redistributions in binary form must reproduce the above copyright notice, this list of conditions and the following disclaimer in the documentation and/or other materials provided with the distribution.
3. Neither the name of Apple Inc. ("Apple") nor the names of its contributors may be used to endorse or promote products derived from this software without specific prior written permission.

THIS SOFTWARE IS PROVIDED BY APPLE AND ITS CONTRIBUTORS "AS IS" AND ANY EXPRESS OR IMPLIED WARRANTIES, INCLUDING, BUT NOT LIMITED TO, THE IMPLIED WARRANTIES OF MERCHANTABILITY AND FITNESS FOR A PARTICULAR PURPOSE ARE DISCLAIMED. IN NO EVENT SHALL APPLE OR ITS CONTRIBUTORS BE LIABLE FOR ANY DIRECT, INDIRECT, INCIDENTAL, SPECIAL, EXEMPLARY, OR CONSEQUENTIAL DAMAGES (INCLUDING, BUT NOT LIMITED TO, PROCUREMENT OF SUBSTITUTE GOODS OR SERVICES; LOSS OF USE, DATA, OR PROFITS; OR BUSINESS INTERRUPTION) HOWEVER CAUSED AND ON ANY THEORY OF LIABILITY, WHETHER IN CONTRACT, STRICT LIABILITY, OR TORT (INCLUDING NEGLIGENCE OR OTHERWISE) ARISING IN ANY WAY OUT OF THE USE OF THIS SOFTWARE, EVEN IF ADVISED OF THE POSSIBILITY OF SUCH DAMAGE.

Apache License

Version 2.0, January 2004

<http://www.apache.org/licenses/>

TERMS AND CONDITIONS FOR USE, REPRODUCTION, AND DISTRIBUTION

1. Definitions.

"License" shall mean the terms and conditions for use, reproduction, and distribution as defined by Sections 1 through 9 of this document.

"Licensor" shall mean the copyright owner or entity authorized by the copyright owner that is granting the License.

"Legal Entity" shall mean the union of the acting entity and all other entities that control, are controlled by, or are under common control with that entity. For the purposes of this definition, "control" means (i) the power, direct or indirect, to cause the direction or management of such entity, whether by contract or otherwise, or (ii) ownership of fifty percent (50%) or more of the outstanding shares, or (iii) beneficial ownership of such entity.

"You" (or "Your") shall mean an individual or Legal Entity exercising permissions granted by this License.

"Source" form shall mean the preferred form for making modifications, including but not limited to software source code, documentation source, and configuration files.

"Object" form shall mean any form resulting from mechanical transformation or translation of a Source form, including but not limited to compiled object code, generated documentation, and conversions to other media types.

"Work" shall mean the work of authorship, whether in Source or Object form, made available under the License, as indicated by a copyright notice that is included in or attached to the work (an example is provided in the Appendix below).

"Derivative Works" shall mean any work, whether in Source or Object form, that is based on (or derived from) the Work and for which the editorial revisions, annotations, elaborations, or other modifications represent, as a whole, an original work of authorship. For the purposes of this License, Derivative Works shall not include works that remain separable from, or merely link (or bind by name) to the interfaces of, the Work and Derivative Works thereof.

"Contribution" shall mean any work of authorship, including the original version of the Work and any modifications or additions to that Work or Derivative Works thereof, that is intentionally submitted to Licensor for inclusion in the Work by the copyright owner or by an individual or Legal Entity authorized to submit on behalf of the copyright owner. For the purposes of this definition, "submitted" means any form of electronic, verbal, or written communication sent to the Licensor or its representatives, including but not limited to communication on electronic mailing lists, source code control systems, and issue tracking systems that are managed by, or on behalf of, the Licensor for the purpose of discussing and improving the Work, but excluding communication that is conspicuously marked or otherwise designated in writing by the copyright owner as "Not a Contribution."

"Contributor" shall mean Licensor and any individual or Legal Entity on behalf of whom a Contribution has been received by Licensor and subsequently incorporated within the Work.

2. Grant of Copyright License. Subject to the terms and conditions of this License, each Contributor hereby grants to You a perpetual, worldwide, non-exclusive, no-charge, royalty-free, irrevocable copyright license to reproduce, prepare Derivative Works of, publicly display, publicly perform, sublicense, and distribute the Work and such Derivative Works in Source or Object form.
3. Grant of Patent License. Subject to the terms and conditions of this License, each Contributor hereby grants to You a perpetual, worldwide, non-exclusive, no-charge, royalty-free, irrevocable (except as stated in this section) patent license to make, have made, use, offer to sell, sell, import, and otherwise transfer the Work, where such license applies only to those patent claims licensable by such Contributor that are necessarily infringed by their Contribution(s) alone or by combination of their Contribution(s) with the Work to which such Contribution(s) was submitted. If You institute patent litigation against any entity (including a cross-claim or counterclaim in a lawsuit) alleging that the Work or a Contribution incorporated within the Work constitutes direct or contributory patent infringement, then any patent licenses granted to You under this License for that Work shall terminate as of the date such litigation is filed.
4. Redistribution. You may reproduce and distribute copies of the Work or Derivative Works thereof in any medium, with or without modifications, and in Source or Object form, provided that You meet the following conditions:
 1. You must give any other recipients of the Work or Derivative Works a copy of this License; and
 2. You must cause any modified files to carry prominent notices stating that You changed the files; and

3. You must retain, in the Source form of any Derivative Works that You distribute, all copyright, patent, trademark, and attribution notices from the Source form of the Work, excluding those notices that do not pertain to any part of the Derivative Works; and
4. If the Work includes a "NOTICE" text file as part of its distribution, then any Derivative Works that You distribute must include a readable copy of the attribution notices contained within such NOTICE file, excluding those notices that do not pertain to any part of the Derivative Works, in at least one of the following places: within a NOTICE text file distributed as part of the Derivative Works; within the Source form or documentation, if provided along with the Derivative Works; or, within a display generated by the Derivative Works, if and wherever such third-party notices normally appear. The contents of the NOTICE file are for informational purposes only and do not modify the License. You may add Your own attribution notices within Derivative Works that You distribute, alongside or as an addendum to the NOTICE text from the Work, provided that such additional attribution notices cannot be construed as modifying the License.

You may add Your own copyright statement to Your modifications and may provide additional or different license terms and conditions for use, reproduction, or distribution of Your modifications, or for any such Derivative Works as a whole, provided Your use, reproduction, and distribution of the Work otherwise complies with the conditions stated in this License.

5. Submission of Contributions. Unless You explicitly state otherwise, any Contribution intentionally submitted for inclusion in the Work by You to the Licensor shall be under the terms and conditions of this License, without any additional terms or conditions. Notwithstanding the above, nothing herein shall supersede or modify the terms of any separate license agreement you may have executed with Licensor regarding such Contributions.
6. Trademarks. This License does not grant permission to use the trade names, trademarks, service marks, or product names of the Licensor, except as required for reasonable and customary use in describing the origin of the Work and reproducing the content of the NOTICE file.
7. Disclaimer of Warranty. Unless required by applicable law or agreed to in writing, Licensor provides the Work (and each Contributor provides its Contributions) on an "AS IS" BASIS, WITHOUT WARRANTIES OR CONDITIONS OF ANY KIND, either express or implied, including, without limitation, any warranties or conditions of TITLE, NON-INFRINGEMENT, MERCHANTABILITY, or FITNESS FOR A PARTICULAR PURPOSE. You are solely responsible for determining the appropriateness of using or redistributing the Work and assume any risks associated with Your exercise of permissions under this License.
8. Limitation of Liability. In no event and under no legal theory, whether in tort (including negligence), contract, or otherwise, unless required by applicable law (such as deliberate and grossly negligent acts) or agreed to in writing, shall any Contributor be liable to You for damages, including any direct, indirect, special, incidental, or consequential damages of any character arising as a result of this License or out of the use or inability to use the Work (including but not limited to damages for loss of goodwill, work stoppage, computer failure or malfunction, or any and all other commercial damages or losses), even if such Contributor has been advised of the possibility of such damages.
9. Accepting Warranty or Additional Liability. While redistributing the Work or Derivative Works thereof, You may choose to offer, and charge a fee for, acceptance of support, warranty, indemnity, or other liability obligations and/or rights consistent with this License. However, in accepting such obligations, You may act only on Your own behalf and on Your sole responsibility, not on behalf of any other Contributor, and only if You agree to indemnify, defend, and hold each Contributor harmless for any liability incurred by, or claims asserted against, such Contributor by reason of your accepting any

such warranty or additional liability.
END OF TERMS AND CONDITIONS

---- Part 1: CMU/UCD copyright notice: (BSD like) ----

Copyright 1989, 1991, 1992 by Carnegie Mellon University

Derivative Work - 1996, 1998-2000

Copyright 1996, 1998-2000 The Regents of the University of California

All Rights Reserved

Permission to use, copy, modify and distribute this software and its documentation for any purpose and without fee is hereby granted, provided that the above copyright notice appears in all copies and that both that copyright notice and this permission notice appear in supporting documentation, and that the name of CMU and The Regents of the University of California not be used in advertising or publicity pertaining to distribution of the software without specific written permission.

CMU AND THE REGENTS OF THE UNIVERSITY OF CALIFORNIA DISCLAIM ALL WARRANTIES WITH REGARD TO THIS SOFTWARE, INCLUDING ALL IMPLIED WARRANTIES OF MERCHANTABILITY AND FITNESS. IN NO EVENT SHALL CMU OR THE REGENTS OF THE UNIVERSITY OF CALIFORNIA BE LIABLE FOR ANY SPECIAL, INDIRECT OR CONSEQUENTIAL DAMAGES OR ANY DAMAGES WHATSOEVER RESULTING FROM THE LOSS OF USE, DATA OR PROFITS, WHETHER IN AN ACTION OF CONTRACT, NEGLIGENCE OR OTHER TORTIOUS ACTION, ARISING OUT OF OR IN CONNECTION WITH THE USE OR PERFORMANCE OF THIS SOFTWARE.

---- Part 2: Networks Associates Technology, Inc copyright notice (BSD) ----

Copyright (c) 2001-2003, Networks Associates Technology, Inc

All rights reserved.

Redistribution and use in source and binary forms, with or without modification, are permitted provided that the following conditions are met:

- * Redistributions of source code must retain the above copyright notice, this list of conditions and the following disclaimer.
- * Redistributions in binary form must reproduce the above copyright notice, this list of conditions and the following disclaimer in the documentation and/or other materials provided with the distribution.
- * Neither the name of the Networks Associates Technology, Inc nor the names of its contributors may be used to endorse or promote products derived from this software without specific prior written permission.

THIS SOFTWARE IS PROVIDED BY THE COPYRIGHT HOLDERS AND CONTRIBUTORS "AS IS" AND ANY EXPRESS OR IMPLIED WARRANTIES, INCLUDING, BUT NOT LIMITED TO, THE IMPLIED WARRANTIES OF MERCHANTABILITY AND FITNESS FOR A PARTICULAR PURPOSE ARE DISCLAIMED. IN NO EVENT SHALL THE COPYRIGHT HOLDERS OR CONTRIBUTORS BE LIABLE FOR ANY DIRECT, INDIRECT, INCIDENTAL, SPECIAL, EXEMPLARY, OR CONSEQUENTIAL DAMAGES (INCLUDING, BUT NOT LIMITED TO, PROCUREMENT OF SUBSTITUTE GOODS OR SERVICES; LOSS OF USE, DATA, OR PROFITS; OR BUSINESS INTERRUPTION) HOWEVER CAUSED AND ON ANY THEORY OF LIABILITY, WHETHER IN CONTRACT, STRICT LIABILITY, OR TORT (INCLUDING NEGLIGENCE OR OTHERWISE) ARISING IN ANY WAY OUT OF THE USE OF THIS SOFTWARE, EVEN IF ADVISED OF THE POSSIBILITY OF SUCH DAMAGE.

---- Part 3: Cambridge Broadband Ltd. copyright notice (BSD) -----

Portions of this code are copyright (c) 2001-2003, Cambridge Broadband Ltd.

All rights reserved.

Redistribution and use in source and binary forms, with or without modification, are permitted provided that the following conditions are met:

- * Redistributions of source code must retain the above copyright notice, this list of conditions and the following disclaimer.
- * Redistributions in binary form must reproduce the above copyright notice, this list of conditions and the following disclaimer in the documentation and/or other materials provided with the distribution.
- * The name of Cambridge Broadband Ltd. may not be used to endorse or promote products derived from this software without specific prior written permission.

THIS SOFTWARE IS PROVIDED BY THE COPYRIGHT HOLDER ``AS IS" AND ANY EXPRESS OR IMPLIED WARRANTIES, INCLUDING, BUT NOT LIMITED TO, THE IMPLIED WARRANTIES OF MERCHANTABILITY AND FITNESS FOR A PARTICULAR PURPOSE ARE DISCLAIMED. IN NO EVENT SHALL THE COPYRIGHT HOLDER BE LIABLE FOR ANY DIRECT, INDIRECT, INCIDENTAL, SPECIAL, EXEMPLARY, OR CONSEQUENTIAL DAMAGES (INCLUDING, BUT NOT LIMITED TO, PROCUREMENT OF SUBSTITUTE GOODS OR SERVICES; LOSS OF USE, DATA, OR PROFITS; OR BUSINESS INTERRUPTION) HOWEVER CAUSED AND ON ANY THEORY OF LIABILITY, WHETHER IN CONTRACT, STRICT LIABILITY, OR TORT (INCLUDING NEGLIGENCE OR OTHERWISE) ARISING IN ANY WAY OUT OF THE USE OF THIS SOFTWARE, EVEN IF ADVISED OF THE POSSIBILITY OF SUCH DAMAGE.

---- Part 4: Sun Microsystems, Inc. copyright notice (BSD) -----

Copyright c 2003 Sun Microsystems, Inc., 4150 Network Circle, Santa Clara, California 95054, U.S.A. All rights reserved.

Use is subject to license terms below.

This distribution may include materials developed by third parties.

Sun, Sun Microsystems, the Sun logo and Solaris are trademarks or registered trademarks of Sun Microsystems, Inc. in the U.S. and other countries.

Redistribution and use in source and binary forms, with or without modification, are permitted provided that the following conditions are met:

- * Redistributions of source code must retain the above copyright notice, this list of conditions and the following disclaimer.
- * Redistributions in binary form must reproduce the above copyright notice, this list of conditions and the following disclaimer in the documentation and/or other materials provided with the distribution.
- * Neither the name of the Sun Microsystems, Inc. nor the names of its contributors may be used to endorse or promote products derived from this software without specific prior written permission.

THIS SOFTWARE IS PROVIDED BY THE COPYRIGHT HOLDERS AND CONTRIBUTORS ``AS IS" AND ANY EXPRESS OR IMPLIED WARRANTIES, INCLUDING, BUT NOT LIMITED TO, THE IMPLIED WARRANTIES OF MERCHANTABILITY AND FITNESS FOR A PARTICULAR PURPOSE ARE DISCLAIMED. IN NO EVENT SHALL THE COPYRIGHT HOLDERS OR CONTRIBUTORS BE LIABLE FOR ANY DIRECT, INDIRECT, INCIDENTAL, SPECIAL, EXEMPLARY, OR CONSEQUENTIAL DAMAGES (INCLUDING, BUT NOT LIMITED TO, PROCUREMENT OF SUBSTITUTE GOODS OR

SERVICES; LOSS OF USE, DATA, OR PROFITS; OR BUSINESS INTERRUPTION) HOWEVER CAUSED AND ON ANY THEORY OF LIABILITY, WHETHER IN CONTRACT, STRICT LIABILITY, OR TORT (INCLUDING NEGLIGENCE OR OTHERWISE) ARISING IN ANY WAY OUT OF THE USE OF THIS SOFTWARE, EVEN IF ADVISED OF THE POSSIBILITY OF SUCH DAMAGE.

---- Part 5: Sparta, Inc copyright notice (BSD) ----

Copyright (c) 2003-2012, Sparta, Inc

All rights reserved.

Redistribution and use in source and binary forms, with or without modification, are permitted provided that the following conditions are met:

- * Redistributions of source code must retain the above copyright notice, this list of conditions and the following disclaimer.
- * Redistributions in binary form must reproduce the above copyright notice, this list of conditions and the following disclaimer in the documentation and/or other materials provided with the distribution.
- * Neither the name of Sparta, Inc nor the names of its contributors may be used to endorse or promote products derived from this software without specific prior written permission.

THIS SOFTWARE IS PROVIDED BY THE COPYRIGHT HOLDERS AND CONTRIBUTORS ``AS IS" AND ANY EXPRESS OR IMPLIED WARRANTIES, INCLUDING, BUT NOT LIMITED TO, THE IMPLIED WARRANTIES OF MERCHANTABILITY AND FITNESS FOR A PARTICULAR PURPOSE ARE DISCLAIMED. IN NO EVENT SHALL THE COPYRIGHT HOLDERS OR CONTRIBUTORS BE LIABLE FOR ANY DIRECT, INDIRECT, INCIDENTAL, SPECIAL, EXEMPLARY, OR CONSEQUENTIAL DAMAGES (INCLUDING, BUT NOT LIMITED TO, PROCUREMENT OF SUBSTITUTE GOODS OR SERVICES; LOSS OF USE, DATA, OR PROFITS; OR BUSINESS INTERRUPTION) HOWEVER CAUSED AND ON ANY THEORY OF LIABILITY, WHETHER IN CONTRACT, STRICT LIABILITY, OR TORT (INCLUDING NEGLIGENCE OR OTHERWISE) ARISING IN ANY WAY OUT OF THE USE OF THIS SOFTWARE, EVEN IF ADVISED OF THE POSSIBILITY OF SUCH DAMAGE.

---- Part 6: Cisco/BUPTNIC copyright notice (BSD) ----

Copyright (c) 2004, Cisco, Inc and Information Network Center of Beijing University of Posts and Telecommunications.

All rights reserved.

Redistribution and use in source and binary forms, with or without modification, are permitted provided that the following conditions are met:

- * Redistributions of source code must retain the above copyright notice, this list of conditions and the following disclaimer.
- * Redistributions in binary form must reproduce the above copyright notice, this list of conditions and the following disclaimer in the documentation and/or other materials provided with the distribution.
- * Neither the name of Cisco, Inc, Beijing University of Posts and Telecommunications, nor the names of their contributors may be used to endorse or promote products derived from this software without specific prior written permission.

THIS SOFTWARE IS PROVIDED BY THE COPYRIGHT HOLDERS AND CONTRIBUTORS ``AS IS" AND ANY EXPRESS OR IMPLIED WARRANTIES, INCLUDING, BUT NOT LIMITED TO, THE IMPLIED WARRANTIES OF MERCHANTABILITY AND FITNESS FOR A PARTICULAR PURPOSE

ARE DISCLAIMED. IN NO EVENT SHALL THE COPYRIGHT HOLDERS OR CONTRIBUTORS BE LIABLE FOR ANY DIRECT, INDIRECT, INCIDENTAL, SPECIAL, EXEMPLARY, OR CONSEQUENTIAL DAMAGES (INCLUDING, BUT NOT LIMITED TO, PROCUREMENT OF SUBSTITUTE GOODS OR SERVICES; LOSS OF USE, DATA, OR PROFITS; OR BUSINESS INTERRUPTION) HOWEVER CAUSED AND ON ANY THEORY OF LIABILITY, WHETHER IN CONTRACT, STRICT LIABILITY, OR TORT (INCLUDING NEGLIGENCE OR OTHERWISE) ARISING IN ANY WAY OUT OF THE USE OF THIS SOFTWARE, EVEN IF ADVISED OF THE POSSIBILITY OF SUCH DAMAGE.

---- Part 7: Fabasoft R&D Software GmbH & Co KG copyright notice (BSD) ----

Copyright (c) Fabasoft R&D Software GmbH & Co KG, 2003 oss@fabasoft.com

Author: Bernhard Penz <bernhard.penz@fabasoft.com>

Redistribution and use in source and binary forms, with or without modification, are permitted provided that the following conditions are met:

- * Redistributions of source code must retain the above copyright notice, this list of conditions and the following disclaimer.
- * Redistributions in binary form must reproduce the above copyright notice, this list of conditions and the following disclaimer in the documentation and/or other materials provided with the distribution.
- * The name of Fabasoft R&D Software GmbH & Co KG or any of its subsidiaries, brand or product names may not be used to endorse or promote products derived from this software without specific prior written permission.

THIS SOFTWARE IS PROVIDED BY THE COPYRIGHT HOLDER "AS IS" AND ANY EXPRESS OR IMPLIED WARRANTIES, INCLUDING, BUT NOT LIMITED TO, THE IMPLIED WARRANTIES OF MERCHANTABILITY AND FITNESS FOR A PARTICULAR PURPOSE ARE DISCLAIMED. IN NO EVENT SHALL THE COPYRIGHT HOLDER BE LIABLE FOR ANY DIRECT, INDIRECT, INCIDENTAL, SPECIAL, EXEMPLARY, OR CONSEQUENTIAL DAMAGES (INCLUDING, BUT NOT LIMITED TO, PROCUREMENT OF SUBSTITUTE GOODS OR SERVICES; LOSS OF USE, DATA, OR PROFITS; OR BUSINESS INTERRUPTION) HOWEVER CAUSED AND ON ANY THEORY OF LIABILITY, WHETHER IN CONTRACT, STRICT LIABILITY, OR TORT (INCLUDING NEGLIGENCE OR OTHERWISE) ARISING IN ANY WAY OUT OF THE USE OF THIS SOFTWARE, EVEN IF ADVISED OF THE POSSIBILITY OF SUCH DAMAGE.

---- Part 8: Apple Inc. copyright notice (BSD) ----

Copyright (c) 2007 Apple Inc. All rights reserved.

Redistribution and use in source and binary forms, with or without modification, are permitted provided that the following conditions are met:

1. Redistributions of source code must retain the above copyright notice, this list of conditions and the following disclaimer.
2. Redistributions in binary form must reproduce the above copyright notice, this list of conditions and the following disclaimer in the documentation and/or other materials provided with the distribution.
3. Neither the name of Apple Inc. ("Apple") nor the names of its contributors may be used to endorse or promote products derived from this software without specific prior written permission.

THIS SOFTWARE IS PROVIDED BY APPLE AND ITS CONTRIBUTORS "AS IS" AND ANY EXPRESS OR IMPLIED WARRANTIES, INCLUDING, BUT NOT LIMITED TO, THE IMPLIED WARRANTIES

OF MERCHANTABILITY AND FITNESS FOR A PARTICULAR PURPOSE ARE DISCLAIMED. IN NO EVENT SHALL APPLE OR ITS CONTRIBUTORS BE LIABLE FOR ANY DIRECT, INDIRECT, INCIDENTAL, SPECIAL, EXEMPLARY, OR CONSEQUENTIAL DAMAGES (INCLUDING, BUT NOT LIMITED TO, PROCUREMENT OF SUBSTITUTE GOODS OR SERVICES; LOSS OF USE, DATA, OR PROFITS; OR BUSINESS INTERRUPTION) HOWEVER CAUSED AND ON ANY THEORY OF LIABILITY, WHETHER IN CONTRACT, STRICT LIABILITY, OR TORT (INCLUDING NEGLIGENCE OR OTHERWISE) ARISING IN ANY WAY OUT OF THE USE OF THIS SOFTWARE, EVEN IF ADVISED OF THE POSSIBILITY OF SUCH DAMAGE.

---- Part 9: ScienceLogic, LLC copyright notice (BSD) ----

Copyright (c) 2009, ScienceLogic, LLC

All rights reserved.

Redistribution and use in source and binary forms, with or without modification, are permitted provided that the following conditions are met:

- * Redistributions of source code must retain the above copyright notice, this list of conditions and the following disclaimer.
- * Redistributions in binary form must reproduce the above copyright notice, this list of conditions and the following disclaimer in the documentation and/or other materials provided with the distribution.
- * Neither the name of ScienceLogic, LLC nor the names of its contributors may be used to endorse or promote products derived from this software without specific prior written permission.

THIS SOFTWARE IS PROVIDED BY THE COPYRIGHT HOLDERS AND CONTRIBUTORS "AS IS" AND ANY EXPRESS OR IMPLIED WARRANTIES, INCLUDING, BUT NOT LIMITED TO, THE IMPLIED WARRANTIES OF MERCHANTABILITY AND FITNESS FOR A PARTICULAR PURPOSE ARE DISCLAIMED. IN NO EVENT SHALL THE COPYRIGHT HOLDERS OR CONTRIBUTORS BE LIABLE FOR ANY DIRECT, INDIRECT, INCIDENTAL, SPECIAL, EXEMPLARY, OR CONSEQUENTIAL DAMAGES (INCLUDING, BUT NOT LIMITED TO, PROCUREMENT OF SUBSTITUTE GOODS OR SERVICES; LOSS OF USE, DATA, OR PROFITS; OR BUSINESS INTERRUPTION) HOWEVER CAUSED AND ON ANY THEORY OF LIABILITY, WHETHER IN CONTRACT, STRICT LIABILITY, OR TORT (INCLUDING NEGLIGENCE OR OTHERWISE) ARISING IN ANY WAY OUT OF THE USE OF THIS SOFTWARE, EVEN IF ADVISED OF THE POSSIBILITY OF SUCH DAMAGE.

MIT License

Copyright (c) 1998, 1999, 2000 Thai Open Source Software Center Ltd

Permission is hereby granted, free of charge, to any person obtaining a copy of this software and associated documentation files (the "Software"), to deal in the Software without restriction, including without limitation the rights to use, copy, modify, merge, publish, distribute, sublicense, and/or sell copies of the Software, and to permit persons to whom the Software is furnished to do so, subject to the following conditions:

The above copyright notice and this permission notice shall be included in all copies or substantial portions of the Software.

THE SOFTWARE IS PROVIDED "AS IS", WITHOUT WARRANTY OF ANY KIND, EXPRESS OR IMPLIED, INCLUDING BUT NOT LIMITED TO THE WARRANTIES OF MERCHANTABILITY, FITNESS FOR A PARTICULAR PURPOSE AND NONINFRINGEMENT. IN NO EVENT SHALL THE AUTHORS

OR COPYRIGHT HOLDERS BE LIABLE FOR ANY CLAIM, DAMAGES OR OTHER LIABILITY, WHETHER IN AN ACTION OF CONTRACT, TORT OR OTHERWISE, ARISING FROM, OUT OF OR IN CONNECTION WITH THE SOFTWARE OR THE USE OR OTHER DEALINGS IN THE SOFTWARE.

Copyright 2000 Computing Research Labs, New Mexico State University

Copyright 2001-2015 Francesco Zappa Nardelli

Permission is hereby granted, free of charge, to any person obtaining a copy of this software and associated documentation files (the "Software"), to deal in the Software without restriction, including without limitation the rights to use, copy, modify, merge, publish, distribute, sublicense, and/or sell copies of the Software, and to permit persons to whom the Software is furnished to do so, subject to the following conditions:

The above copyright notice and this permission notice shall be included in all copies or substantial portions of the Software.

THE SOFTWARE IS PROVIDED "AS IS", WITHOUT WARRANTY OF ANY KIND, EXPRESS OR IMPLIED, INCLUDING BUT NOT LIMITED TO THE WARRANTIES OF MERCHANTABILITY, FITNESS FOR A PARTICULAR PURPOSE AND NONINFRINGEMENT. IN NO EVENT SHALL THE COMPUTING RESEARCH LAB OR NEW MEXICO STATE UNIVERSITY BE LIABLE FOR ANY CLAIM, DAMAGES OR OTHER LIABILITY, WHETHER IN AN ACTION OF CONTRACT, TORT OR OTHERWISE, ARISING FROM, OUT OF OR IN CONNECTION WITH THE SOFTWARE OR THE USE OR OTHER DEALINGS IN THE SOFTWARE.

Written by Joel Sherrill <joel@OARcorp.com>.

COPYRIGHT (c) 1989-2000.

On-Line Applications Research Corporation (OAR).

Permission to use, copy, modify, and distribute this software for any purpose without fee is hereby granted, provided that this entire notice is included in all copies of any software which is or includes a copy or modification of this software.

THIS SOFTWARE IS BEING PROVIDED "AS IS", WITHOUT ANY EXPRESS OR IMPLIED WARRANTY. IN PARTICULAR, THE AUTHOR MAKES NO REPRESENTATION OR WARRANTY OF ANY KIND CONCERNING THE MERCHANTABILITY OF THIS SOFTWARE OR ITS FITNESS FOR ANY PARTICULAR PURPOSE.

(1) Red Hat Incorporated

Copyright (c) 1994-2009 Red Hat, Inc. All rights reserved.

This copyrighted material is made available to anyone wishing to use, modify, copy, or redistribute it subject to the terms and conditions of the BSD License. This program is distributed in the hope that it will be useful, but WITHOUT ANY WARRANTY expressed or implied, including the implied warranties of MERCHANTABILITY or FITNESS FOR A PARTICULAR PURPOSE. A copy of this license is available at <http://www.opensource.org/licenses>. Any Red Hat trademarks that are incorporated in the source code or documentation are not subject to the BSD License and may only be used or replicated with the express permission of Red Hat, Inc.

(2) University of California, Berkeley

Copyright (c) 1981-2000 The Regents of the University of California.

All rights reserved.

Redistribution and use in source and binary forms, with or without modification, are permitted provided that the following conditions are met:

- * Redistributions of source code must retain the above copyright notice, this list of conditions and the following disclaimer.
- * Redistributions in binary form must reproduce the above copyright notice, this list of conditions and the following disclaimer in the documentation and/or other materials provided with the distribution.
- * Neither the name of the University nor the names of its contributors may be used to endorse or promote products derived from this software without specific prior written permission.

THIS SOFTWARE IS PROVIDED BY THE COPYRIGHT HOLDERS AND CONTRIBUTORS "AS IS" AND ANY EXPRESS OR IMPLIED WARRANTIES, INCLUDING, BUT NOT LIMITED TO, THE IMPLIED WARRANTIES OF MERCHANTABILITY AND FITNESS FOR A PARTICULAR PURPOSE ARE DISCLAIMED. IN NO EVENT SHALL THE COPYRIGHT OWNER OR CONTRIBUTORS BE LIABLE FOR ANY DIRECT, INDIRECT, INCIDENTAL, SPECIAL, EXEMPLARY, OR CONSEQUENTIAL DAMAGES (INCLUDING, BUT NOT LIMITED TO, PROCUREMENT OF SUBSTITUTE GOODS OR SERVICES; LOSS OF USE, DATA, OR PROFITS; OR BUSINESS INTERRUPTION) HOWEVER CAUSED AND ON ANY THEORY OF LIABILITY, WHETHER IN CONTRACT, STRICT LIABILITY, OR TORT (INCLUDING NEGLIGENCE OR OTHERWISE) ARISING IN ANY WAY OUT OF THE USE OF THIS SOFTWARE, EVEN IF ADVISED OF THE POSSIBILITY OF SUCH DAMAGE.

The FreeType Project LICENSE

2006-Jan-27

Copyright 1996-2002, 2006 by

David Turner, Robert Wilhelm, and Werner Lemberg

Introduction

=====

The FreeType Project is distributed in several archive packages; some of them may contain, in addition to the FreeType font engine, various tools and contributions which rely on, or relate to, the FreeType Project.

This license applies to all files found in such packages, and which do not fall under their own explicit license. The license affects thus the FreeType font engine, the test programs, documentation and makefiles, at the very least.

This license was inspired by the BSD, Artistic, and IJG (Independent JPEG Group) licenses, which all encourage inclusion and use of free software in commercial and freeware products alike. As a consequence, its main points are that:

- o We don't promise that this software works. However, we will be interested in any kind of bug reports. (``as is'` distribution)
- o You can use this software for whatever you want, in parts or full form, without having to pay us. (``royalty-free'` usage)
- o You may not pretend that you wrote this software. If you use it, or only parts of it, in a program, you must acknowledge somewhere in your documentation that you have used the FreeType code. (``credits'`)

We specifically permit and encourage the inclusion of this software, with or without modifications, in commercial products.

We disclaim all warranties covering The FreeType Project and assume no liability related to The FreeType Project.

Finally, many people asked us for a preferred form for a credit/disclaimer to use in compliance with this license. We thus encourage you to use the following text:

""

Portions of this software are copyright © <year> The FreeType Project (www.freetype.org). All rights reserved.

""

Please replace <year> with the value from the FreeType version you actually use.

Legal Terms

=====

0. Definitions

Throughout this license, the terms 'package', 'FreeType Project', and 'FreeType archive' refer to the set of files originally distributed by the authors (David Turner, Robert Wilhelm, and Werner Lemberg) as the 'FreeType Project', be they named as alpha, beta or final release.

'You' refers to the licensee, or person using the project, where 'using' is a generic term including compiling the project's source code as well as linking it to form a 'program' or 'executable'.

This program is referred to as 'a program using the FreeType engine'.

This license applies to all files distributed in the original FreeType Project, including all source code, binaries and documentation, unless otherwise stated in the file in its original, unmodified form as distributed in the original archive.

If you are unsure whether or not a particular file is covered by this license, you must contact us to verify this.

The FreeType Project is copyright (C) 1996-2000 by David Turner, Robert Wilhelm, and Werner Lemberg. All rights reserved except as specified below.

1. No Warranty

THE FREETYPE PROJECT IS PROVIDED 'AS IS' WITHOUT WARRANTY OF ANY KIND, EITHER EXPRESS OR IMPLIED, INCLUDING, BUT NOT LIMITED TO, WARRANTIES OF MERCHANTABILITY AND FITNESS FOR A PARTICULAR PURPOSE. IN NO EVENT WILL ANY OF THE AUTHORS OR COPYRIGHT HOLDERS BE LIABLE FOR ANY DAMAGES CAUSED BY THE USE OR THE INABILITY TO USE, OF THE FREETYPE PROJECT.

2. Redistribution

This license grants a worldwide, royalty-free, perpetual and irrevocable right and license to use, execute, perform, compile, display, copy, create derivative works of, distribute and sublicense the FreeType Project

(in both source and object code forms) and derivative works thereof for any purpose; and to authorize others to exercise some or all of the rights granted herein, subject to the following conditions:

- o Redistribution of source code must retain this license file ('FTL.TXT') unaltered; any additions, deletions or changes to the original files must be clearly indicated in accompanying documentation. The copyright notices of the unaltered, original files must be preserved in all copies of source files.

- o Redistribution in binary form must provide a disclaimer that states that the software is based in part of the work of the FreeType Team, in the distribution documentation. We also encourage you to put an URL to the FreeType web page in your documentation, though this isn't mandatory.

These conditions apply to any software derived from or based on the FreeType Project, not just the unmodified files. If you use our work, you must acknowledge us. However, no fee need be paid to us.

3. Advertising

Neither the FreeType authors and contributors nor you shall use the name of the other for commercial, advertising, or promotional purposes without specific prior written permission.

We suggest, but do not require, that you use one or more of the following phrases to refer to this software in your documentation or advertising materials: 'FreeType Project', 'FreeType Engine', 'FreeType library', or 'FreeType Distribution'.

As you have not signed this license, you are not required to accept it. However, as the FreeType Project is copyrighted material, only this license, or another one contracted with the authors, grants you the right to use, distribute, and modify it.

Therefore, by using, distributing, or modifying the FreeType Project, you indicate that you understand and accept all the terms of this license.

4. Contacts

There are two mailing lists related to FreeType:

- o freetype@nongnu.org

Discusses general use and applications of FreeType, as well as future and wanted additions to the library and distribution.

If you are looking for support, start in this list if you haven't found anything to help you in the documentation.

- o freetype-devel@nongnu.org

Discusses bugs, as well as engine internals, design issues, specific licenses, porting, etc.

Our home page can be found at

<http://www.freetype.org>

--- end of FTL.TXT ---

The TWAIN Toolkit is distributed as is. The developer and distributors of the TWAIN Toolkit expressly disclaim all implied, express or statutory warranties including, without limitation, the implied warranties of merchantability, noninfringement of third party rights and fitness for a particular purpose. Neither the

developers nor the distributors will be liable for damages, whether direct, indirect, special, incidental, or consequential, as a result of the reproduction, modification, distribution or other use of the TWAIN Toolkit.

JSON for Modern C++

Copyright (c) 2013-2017 Niels Lohmann

Permission is hereby granted, free of charge, to any person obtaining a copy of this software and associated documentation files (the "Software"), to deal in the Software without restriction, including without limitation the rights to use, copy, modify, merge, publish, distribute, sublicense, and/or sell copies of the Software, and to permit persons to whom the Software is furnished to do so, subject to the following conditions:

The above copyright notice and this permission notice shall be included in all copies or substantial portions of the Software.

THE SOFTWARE IS PROVIDED "AS IS", WITHOUT WARRANTY OF ANY KIND, EXPRESS OR IMPLIED, INCLUDING BUT NOT LIMITED TO THE WARRANTIES OF MERCHANTABILITY, FITNESS FOR A PARTICULAR PURPOSE AND NONINFRINGEMENT. IN NO EVENT SHALL THE AUTHORS OR COPYRIGHT HOLDERS BE LIABLE FOR ANY CLAIM, DAMAGES OR OTHER LIABILITY, WHETHER IN AN ACTION OF CONTRACT, TORT OR OTHERWISE, ARISING FROM, OUT OF OR IN CONNECTION WITH THE SOFTWARE OR THE USE OR OTHER DEALINGS IN THE SOFTWARE.

Copyright (c) 2011 - 2015 ARM LIMITED

All rights reserved.

Redistribution and use in source and binary forms, with or without modification, are permitted provided that the following conditions are met:

- Redistributions of source code must retain the above copyright notice, this list of conditions and the following disclaimer.
- Redistributions in binary form must reproduce the above copyright notice, this list of conditions and the following disclaimer in the documentation and/or other materials provided with the distribution.
- Neither the name of ARM nor the names of its contributors may be used to endorse or promote products derived from this software without specific prior written permission.

THIS SOFTWARE IS PROVIDED BY THE COPYRIGHT HOLDERS AND CONTRIBUTORS "AS IS" AND ANY EXPRESS OR IMPLIED WARRANTIES, INCLUDING, BUT NOT LIMITED TO, THE IMPLIED WARRANTIES OF MERCHANTABILITY AND FITNESS FOR A PARTICULAR PURPOSE ARE DISCLAIMED. IN NO EVENT SHALL COPYRIGHT HOLDERS AND CONTRIBUTORS BE LIABLE FOR ANY DIRECT, INDIRECT, INCIDENTAL, SPECIAL, EXEMPLARY, OR CONSEQUENTIAL DAMAGES (INCLUDING, BUT NOT LIMITED TO, PROCUREMENT OF SUBSTITUTE GOODS OR SERVICES; LOSS OF USE, DATA, OR PROFITS; OR BUSINESS INTERRUPTION) HOWEVER CAUSED AND ON ANY THEORY OF LIABILITY, WHETHER IN CONTRACT, STRICT LIABILITY, OR TORT (INCLUDING NEGLIGENCE OR OTHERWISE) ARISING IN ANY WAY OUT OF THE USE OF THIS SOFTWARE, EVEN IF ADVISED OF THE POSSIBILITY OF SUCH DAMAGE.

Copyright (c) 2014, Kenneth MacKay

All rights reserved.

Redistribution and use in source and binary forms, with or without modification, are permitted provided that the following conditions are met:

- * Redistributions of source code must retain the above copyright notice, this list of conditions and the following disclaimer.

- * Redistributions in binary form must reproduce the above copyright notice, this list of conditions and the following disclaimer in the documentation and/or other materials provided with the distribution.

THIS SOFTWARE IS PROVIDED BY THE COPYRIGHT HOLDERS AND CONTRIBUTORS "AS IS" AND ANY EXPRESS OR IMPLIED WARRANTIES, INCLUDING, BUT NOT LIMITED TO, THE IMPLIED WARRANTIES OF MERCHANTABILITY AND FITNESS FOR A PARTICULAR PURPOSE ARE DISCLAIMED. IN NO EVENT SHALL THE COPYRIGHT HOLDER OR CONTRIBUTORS BE LIABLE FOR ANY DIRECT, INDIRECT, INCIDENTAL, SPECIAL, EXEMPLARY, OR CONSEQUENTIAL DAMAGES (INCLUDING, BUT NOT LIMITED TO, PROCUREMENT OF SUBSTITUTE GOODS OR SERVICES; LOSS OF USE, DATA, OR PROFITS; OR BUSINESS INTERRUPTION) HOWEVER CAUSED AND ON ANY THEORY OF LIABILITY, WHETHER IN CONTRACT, STRICT LIABILITY, OR TORT (INCLUDING NEGLIGENCE OR OTHERWISE) ARISING IN ANY WAY OUT OF THE USE OF THIS SOFTWARE, EVEN IF ADVISED OF THE POSSIBILITY OF SUCH DAMAGE.

Copyright (c) 2006, CRYPTOGRAMS by <appro@openssl.org> All rights reserved.

Redistribution and use in source and binary forms, with or without modification, are permitted provided that the following conditions are met:

- * Redistributions of source code must retain copyright notices, this list of conditions and the following disclaimer.

- * Redistributions in binary form must reproduce the above copyright notice, this list of conditions and the following disclaimer in the documentation and/or other materials provided with the distribution.

- * Neither the name of the CRYPTOGRAMS nor the names of its copyright holder and contributors may be used to endorse or promote products derived from this software without specific prior written permission.

ALTERNATIVELY, provided that this notice is retained in full, this product may be distributed under the terms of the GNU General Public License (GPL), in which case the provisions of the GPL apply INSTEAD OF those given above.

THIS SOFTWARE IS PROVIDED BY THE COPYRIGHT HOLDER AND CONTRIBUTORS "AS IS" AND ANY EXPRESS OR IMPLIED WARRANTIES, INCLUDING, BUT NOT LIMITED TO, THE IMPLIED WARRANTIES OF MERCHANTABILITY AND FITNESS FOR A PARTICULAR PURPOSE ARE DISCLAIMED. IN NO EVENT SHALL THE COPYRIGHT OWNER OR CONTRIBUTORS BE LIABLE FOR ANY DIRECT, INDIRECT, INCIDENTAL, SPECIAL, EXEMPLARY, OR CONSEQUENTIAL DAMAGES (INCLUDING, BUT NOT LIMITED TO, PROCUREMENT OF SUBSTITUTE GOODS OR SERVICES; LOSS OF USE, DATA, OR PROFITS; OR BUSINESS INTERRUPTION) HOWEVER CAUSED AND ON ANY THEORY OF LIABILITY, WHETHER IN CONTRACT, STRICT LIABILITY, OR TORT (INCLUDING NEGLIGENCE OR OTHERWISE) ARISING IN ANY WAY OUT OF THE USE OF THIS SOFTWARE, EVEN IF ADVISED OF THE POSSIBILITY OF SUCH DAMAGE.

ISC License

Copyright (c) 2013-2017

Frank Denis <j at pureftpd dot org>

Permission to use, copy, modify, and/or distribute this software for any purpose with or without fee is hereby granted, provided that the above copyright notice and this permission notice appear in all copies.

THE SOFTWARE IS PROVIDED "AS IS" AND THE AUTHOR DISCLAIMS ALL WARRANTIES WITH REGARD TO THIS SOFTWARE INCLUDING ALL IMPLIED WARRANTIES OF MERCHANTABILITY AND FITNESS. IN NO EVENT SHALL THE AUTHOR BE LIABLE FOR ANY SPECIAL, DIRECT, INDIRECT, OR CONSEQUENTIAL DAMAGES OR ANY DAMAGES WHATSOEVER RESULTING FROM LOSS OF USE, DATA OR PROFITS, WHETHER IN AN ACTION OF CONTRACT, NEGLIGENCE OR OTHER TORTIOUS ACTION, ARISING OUT OF OR IN CONNECTION WITH THE USE OR PERFORMANCE OF THIS SOFTWARE.

Copyright (c) 2008 The NetBSD Foundation, Inc.

All rights reserved.

This code is derived from software contributed to The NetBSD Foundation by Lennart Augustsson (lennart@augustsson.net) at Carlstedt Research & Technology.

Redistribution and use in source and binary forms, with or without modification, are permitted provided that the following conditions are met:

1. Redistributions of source code must retain the above copyright notice, this list of conditions and the following disclaimer.
2. Redistributions in binary form must reproduce the above copyright notice, this list of conditions and the following disclaimer in the documentation and/or other materials provided with the distribution.

THIS SOFTWARE IS PROVIDED BY THE NETBSD FOUNDATION, INC. AND CONTRIBUTORS "AS IS" AND ANY EXPRESS OR IMPLIED WARRANTIES, INCLUDING, BUT NOT LIMITED TO, THE IMPLIED WARRANTIES OF MERCHANTABILITY AND FITNESS FOR A PARTICULAR PURPOSE ARE DISCLAIMED. IN NO EVENT SHALL THE FOUNDATION OR CONTRIBUTORS BE LIABLE FOR ANY DIRECT, INDIRECT, INCIDENTAL, SPECIAL, EXEMPLARY, OR CONSEQUENTIAL DAMAGES (INCLUDING, BUT NOT LIMITED TO, PROCUREMENT OF SUBSTITUTE GOODS OR SERVICES; LOSS OF USE, DATA, OR PROFITS; OR BUSINESS INTERRUPTION) HOWEVER CAUSED AND ON ANY THEORY OF LIABILITY, WHETHER IN CONTRACT, STRICT LIABILITY, OR TORT (INCLUDING NEGLIGENCE OR OTHERWISE) ARISING IN ANY WAY OUT OF THE USE OF THIS SOFTWARE, EVEN IF ADVISED OF THE POSSIBILITY OF SUCH DAMAGE.

Copyright (c) 2000 Intel Corporation

All rights reserved.

Redistribution and use in source and binary forms, with or without modification, are permitted provided that the following conditions are met:

* Redistributions of source code must retain the above copyright notice, this list of conditions and the following disclaimer.

* Redistributions in binary form must reproduce the above copyright notice, this list of conditions and the following disclaimer in the documentation and/or other materials provided with the distribution.

* Neither name of Intel Corporation nor the names of its contributors may be used to endorse or promote products derived from this software without specific prior written permission.

THIS SOFTWARE IS PROVIDED BY THE COPYRIGHT HOLDERS AND CONTRIBUTORS "AS IS" AND ANY EXPRESS OR IMPLIED WARRANTIES, INCLUDING, BUT NOT LIMITED TO, THE IMPLIED WARRANTIES OF MERCHANTABILITY AND FITNESS FOR A PARTICULAR PURPOSE ARE DISCLAIMED. IN NO EVENT SHALL INTEL OR CONTRIBUTORS BE LIABLE FOR ANY DIRECT, INDIRECT, INCIDENTAL, SPECIAL, EXEMPLARY, OR CONSEQUENTIAL DAMAGES (INCLUDING, BUT NOT LIMITED TO, PROCUREMENT OF SUBSTITUTE GOODS OR SERVICES; LOSS OF USE, DATA, OR PROFITS; OR BUSINESS INTERRUPTION) HOWEVER CAUSED AND ON ANY THEORY OF LIABILITY, WHETHER IN CONTRACT, STRICT LIABILITY, OR TORT (INCLUDING NEGLIGENCE OR OTHERWISE) ARISING IN ANY WAY OUT OF THE USE OF THIS SOFTWARE, EVEN IF ADVISED OF THE POSSIBILITY OF SUCH DAMAGE.

Lua

Copyright © 1994–2014 Lua.org, PUC-Rio.

Permission is hereby granted, free of charge, to any person obtaining a copy of this software and associated documentation files (the "Software"), to deal in the Software without restriction, including without limitation the rights to use, copy, modify, merge, publish, distribute, sublicense, and/or sell copies of the Software, and to permit persons to whom the Software is furnished to do so, subject to the following conditions:

The above copyright notice and this permission notice shall be included in all copies or substantial portions of the Software.

THE SOFTWARE IS PROVIDED "AS IS", WITHOUT WARRANTY OF ANY KIND, EXPRESS OR IMPLIED, INCLUDING BUT NOT LIMITED TO THE WARRANTIES OF MERCHANTABILITY, FITNESS FOR A PARTICULAR PURPOSE AND NONINFRINGEMENT. IN NO EVENT SHALL THE AUTHORS OR COPYRIGHT HOLDERS BE LIABLE FOR ANY CLAIM, DAMAGES OR OTHER LIABILITY, WHETHER IN AN ACTION OF CONTRACT, TORT OR OTHERWISE, ARISING FROM, OUT OF OR IN CONNECTION WITH THE SOFTWARE OR THE USE OR OTHER DEALINGS IN THE SOFTWARE.

LuaSocket

LuaSocket 2.0.2 license

Copyright © 2004-2007 Diego Nehab

Permission is hereby granted, free of charge, to any person obtaining a copy of this software and associated documentation files (the "Software"), to deal in the Software without restriction, including without limitation the rights to use, copy, modify, merge, publish, distribute, sublicense, and/or sell copies of the Software, and to permit persons to whom the Software is furnished to do so, subject to the following conditions:

The above copyright notice and this permission notice shall be included in all copies or substantial portions of the Software.

THE SOFTWARE IS PROVIDED "AS IS", WITHOUT WARRANTY OF ANY KIND, EXPRESS OR IMPLIED, INCLUDING BUT NOT LIMITED TO THE WARRANTIES OF MERCHANTABILITY, FITNESS FOR A PARTICULAR PURPOSE AND NONINFRINGEMENT. IN NO EVENT SHALL THE AUTHORS OR COPYRIGHT HOLDERS BE LIABLE FOR ANY CLAIM, DAMAGES OR OTHER LIABILITY, WHETHER IN AN ACTION OF CONTRACT, TORT OR OTHERWISE, ARISING FROM, OUT OF OR IN CONNECTION WITH THE SOFTWARE OR THE USE OR OTHER DEALINGS IN THE SOFTWARE.

LuneScript

Copyright (c) 2018 ifritJP

Permission is hereby granted, free of charge, to any person obtaining a copy of this software and associated documentation files (the "Software"), to deal in the Software without restriction, including without limitation the rights to use, copy, modify, merge, publish, distribute, sublicense, and/or sell copies of the Software, and to permit persons to whom the Software is furnished to do so, subject to the following conditions:

The above copyright notice and this permission notice shall be included in all copies or substantial portions of the Software.

THE SOFTWARE IS PROVIDED "AS IS", WITHOUT WARRANTY OF ANY KIND, EXPRESS OR IMPLIED, INCLUDING BUT NOT LIMITED TO THE WARRANTIES OF MERCHANTABILITY, FITNESS FOR A PARTICULAR PURPOSE AND NONINFRINGEMENT. IN NO EVENT SHALL THE AUTHORS OR COPYRIGHT HOLDERS BE LIABLE FOR ANY CLAIM, DAMAGES OR OTHER LIABILITY, WHETHER IN AN ACTION OF CONTRACT, TORT OR OTHERWISE, ARISING FROM, OUT OF OR IN CONNECTION WITH THE SOFTWARE OR THE USE OR OTHER DEALINGS IN THE SOFTWARE.

Copyright (c) 2002-2019, Jouni Malinen <j@w1.fi> and contributors
All Rights Reserved.

This software may be distributed, used, and modified under the terms of BSD license:

Redistribution and use in source and binary forms, with or without modification, are permitted provided that the following conditions are met:

1. Redistributions of source code must retain the above copyright notice, this list of conditions and the following disclaimer.
2. Redistributions in binary form must reproduce the above copyright notice, this list of conditions and the following disclaimer in the documentation and/or other materials provided with the distribution.
3. Neither the name(s) of the above-listed copyright holder(s) nor the names of its contributors may be used to endorse or promote products derived from this software without specific prior written permission.

THIS SOFTWARE IS PROVIDED BY THE COPYRIGHT HOLDERS AND CONTRIBUTORS "AS IS" AND ANY EXPRESS OR IMPLIED WARRANTIES, INCLUDING, BUT NOT LIMITED TO, THE IMPLIED WARRANTIES OF MERCHANTABILITY AND FITNESS FOR A PARTICULAR PURPOSE ARE DISCLAIMED. IN NO EVENT SHALL THE COPYRIGHT OWNER OR CONTRIBUTORS BE LIABLE FOR ANY DIRECT, INDIRECT, INCIDENTAL, SPECIAL, EXEMPLARY, OR CONSEQUENTIAL DAMAGES (INCLUDING, BUT NOT LIMITED TO, PROCUREMENT OF SUBSTITUTE GOODS OR SERVICES; LOSS OF USE, DATA, OR PROFITS; OR BUSINESS INTERRUPTION) HOWEVER CAUSED AND ON ANY THEORY OF LIABILITY, WHETHER IN CONTRACT, STRICT LIABILITY, OR TORT (INCLUDING NEGLIGENCE OR OTHERWISE) ARISING IN ANY WAY OUT OF THE USE OF THIS SOFTWARE, EVEN IF ADVISED OF THE POSSIBILITY OF SUCH DAMAGE.

Copyright (C) 2019, Broadcom Corporation. All Rights Reserved.

Permission to use, copy, modify, and/or distribute this software for any purpose with or without fee is hereby granted, provided that the above copyright notice and this permission notice appear in all copies.

THE SOFTWARE IS PROVIDED "AS IS" AND THE AUTHOR DISCLAIMS ALL WARRANTIES WITH REGARD TO THIS SOFTWARE INCLUDING ALL IMPLIED WARRANTIES OF MERCHANTABILITY AND FITNESS. IN NO EVENT SHALL THE AUTHOR BE LIABLE FOR ANY SPECIAL, DIRECT, INDIRECT, OR CONSEQUENTIAL DAMAGES OR ANY DAMAGES WHATSOEVER RESULTING FROM LOSS OF USE, DATA OR PROFITS, WHETHER IN AN ACTION OF CONTRACT, NEGLIGENCE OR OTHER TORTIOUS ACTION, ARISING OUT OF OR IN CONNECTION WITH THE USE OR PERFORMANCE OF THIS SOFTWARE.

The following applies only to products supporting Wi-Fi.

(c) 2009-2013 by Jeff Mott. All rights reserved.

Redistribution and use in source and binary forms, with or without modification, are permitted provided that the following conditions are met:

- * Redistributions of source code must retain the above copyright notice, this list of conditions, and the following disclaimer.
- * Redistributions in binary form must reproduce the above copyright notice, this list of conditions, and the following disclaimer in the documentation or other materials provided with the distribution.

* Neither the name CryptoJS nor the names of its contributors may be used to endorse or promote products derived from this software without specific prior written permission.

THIS SOFTWARE IS PROVIDED BY THE COPYRIGHT HOLDERS AND CONTRIBUTORS "AS IS," AND ANY EXPRESS OR IMPLIED WARRANTIES, INCLUDING, BUT NOT LIMITED TO, THE IMPLIED WARRANTIES OF MERCHANTABILITY AND FITNESS FOR A PARTICULAR PURPOSE, ARE DISCLAIMED. IN NO EVENT SHALL THE COPYRIGHT HOLDER OR CONTRIBUTORS BE LIABLE FOR ANY DIRECT, INDIRECT, INCIDENTAL, SPECIAL, EXEMPLARY, OR CONSEQUENTIAL DAMAGES (INCLUDING, BUT NOT LIMITED TO, PROCUREMENT OF SUBSTITUTE GOODS OR SERVICES; LOSS OF USE, DATA, OR PROFITS; OR BUSINESS INTERRUPTION) HOWEVER CAUSED AND ON ANY THEORY OF LIABILITY, WHETHER IN CONTRACT, STRICT LIABILITY, OR TORT (INCLUDING NEGLIGENCE OR OTHERWISE) ARISING IN ANY WAY OUT OF THE USE OF THIS SOFTWARE, EVEN IF ADVISED OF THE POSSIBILITY OF SUCH DAMAGE.

The following applies only to products supporting PIXUS Cloud Link, PIXMA Cloud Link, or MAXIFY Cloud Link.

THE BASIC LIBRARY FUNCTIONS

Written by: Philip Hazel
Email local part: ph10
Email domain: cam.ac.uk
University of Cambridge Computing Service, Cambridge, England.
Copyright (c) 1997-2012 University of Cambridge
All rights reserved.

PCRE JUST-IN-TIME COMPILATION SUPPORT

Written by: Zoltan Herczeg
Email local part: hzmester
Email domain: freemail.hu
Copyright(c) 2010-2012 Zoltan Herczeg
All rights reserved.

STACK-LESS JUST-IN-TIME COMPILER

Written by: Zoltan Herczeg
Email local part: hzmester
Email domain: freemail.hu
Copyright(c) 2009-2012 Zoltan Herczeg
All rights reserved.

THE C++ WRAPPER FUNCTIONS

Contributed by: Google Inc.
Copyright (c) 2007-2012, Google Inc.
All rights reserved.

THE "BSD" LICENCE

-----Redistribution and use in source and binary forms, with or without modification, are permitted provided that the following conditions are met:

* Redistributions of source code must retain the above copyright notice, this list of conditions and the following disclaimer.

* Redistributions in binary form must reproduce the above copyright notice, this list of conditions and the following disclaimer in the documentation and/or other materials provided with the distribution.

* Neither the name of the University of Cambridge nor the name of Google Inc. nor the names of their contributors may be used to endorse or promote products derived from this software without specific prior written permission.

THIS SOFTWARE IS PROVIDED BY THE COPYRIGHT HOLDERS AND CONTRIBUTORS "AS IS" AND ANY EXPRESS OR IMPLIED WARRANTIES, INCLUDING, BUT NOT LIMITED TO, THE IMPLIED WARRANTIES OF MERCHANTABILITY AND FITNESS FOR A PARTICULAR PURPOSE ARE DISCLAIMED. IN NO EVENT SHALL THE COPYRIGHT OWNER OR CONTRIBUTORS BE LIABLE FOR ANY DIRECT, INDIRECT, INCIDENTAL, SPECIAL, EXEMPLARY, OR CONSEQUENTIAL DAMAGES (INCLUDING, BUT NOT LIMITED TO, PROCUREMENT OF SUBSTITUTE GOODS OR SERVICES; LOSS OF USE, DATA, OR PROFITS; OR BUSINESS INTERRUPTION) HOWEVER CAUSED AND ON ANY THEORY OF LIABILITY, WHETHER IN CONTRACT, STRICT LIABILITY, OR TORT (INCLUDING NEGLIGENCE OR OTHERWISE) ARISING IN ANY WAY OUT OF THE USE OF THIS SOFTWARE, EVEN IF ADVISED OF THE POSSIBILITY OF SUCH DAMAGE.

This software is based in part on the work of the Independent JPEG Group.

Overview

► Printer Parts

- Front
- Back / Side
- Top View
- Inside
- Operation Panel
- Desktop Basket
- Printer Stand

► Using the Printer

- Turning the Printer On and Off
- Loading Rolls in the Printer
- Loading Sheets in the Printer
- Using the Desktop Basket
- Using the Basket on the Printer Stand
- Stopping Printing
- Loading Originals on Document Platen
 - Loading Originals Correctly for each Function

Printer Parts

- **Front**
- **Back / Side**
- **Top View**
- **Inside**
- **Operation Panel**
- **Desktop Basket**
- **Printer Stand**

Front

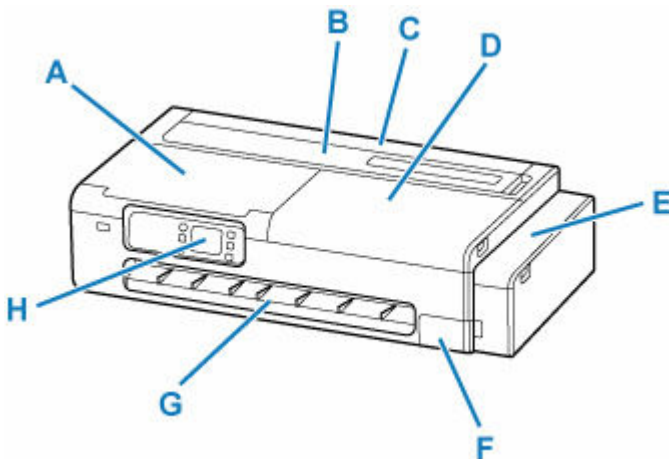

A: Scanning Unit / Cover (TC-20M), Access Cover (TC-20)

Open when performing printer maintenance or when removing jammed paper.

- ➔ [Inside](#)
- ➔ [Scanning Unit \(TC-20M\)](#)

B: Cut Sheet Feed Cover

Open when loading sheets in the top feed.

- ➔ [Top View](#)

C: Roll Paper Feed Cover

Open when loading rolls. Operate with the cut sheet feed cover open.

- ➔ [Top View \(with roll loaded\)](#)

D: Access Cover

Open when performing printer maintenance or when removing jammed paper.

- ➔ [Inside](#)

E: Ink Tank Cover

Open to refill ink tanks.

- ➔ [Inside of Ink Tank Cover, Inside of Maintenance Cover](#)

F: Maintenance Cover

Open when replacing the maintenance cartridge.

- ➔ [Inside of Ink Tank Cover, Inside of Maintenance Cover](#)

G: Output Guide

Supports output paper.

H: Operation Panel

Use to change the settings of the printer or to operate it.

- ➔ [Operation Panel](#)

Scanning Unit (TC-20M)

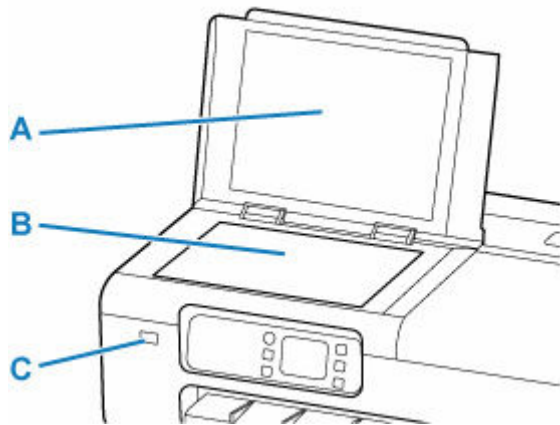

A: Document Cover

Open to load an original on the document platen.

B: Document Platen

Load an original here.

➔ [Loading Originals on Document Platen](#)

C: USB Flash Drive Port

Insert USB flash drives here.

➔ [Printing Photographs Saved on USB Flash Drive](#)

➔ [Printing Documents \(PDF\) Saved on USB Flash Drive](#)

➔ [Saving Scanned Data on USB Flash Drive](#)

Inside of Ink Tank Cover, Inside of Maintenance Cover

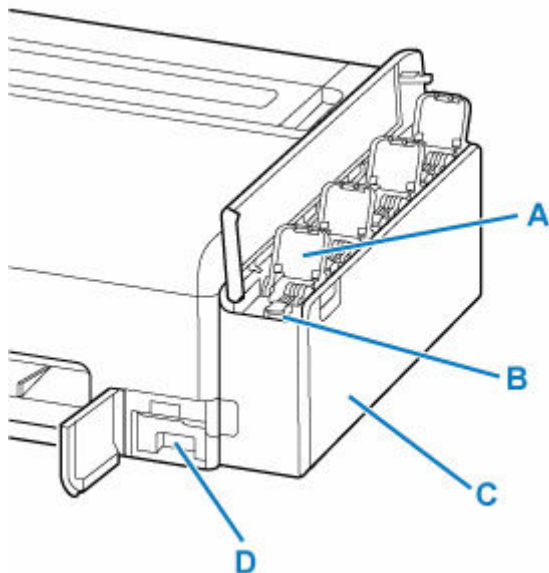

A: Ink Tank Inner Cover

Open to refill ink tanks.

B: Tank Caps

Open to refill ink tanks.

C: Ink Tanks

Containers for ink inside the printer. Refill when the ink runs low.

➔ [Refilling Ink Tanks](#)

D: Maintenance Cartridge

➔ [Maintenance Cartridge](#)

Maintenance Cartridge

Model number: MC-32

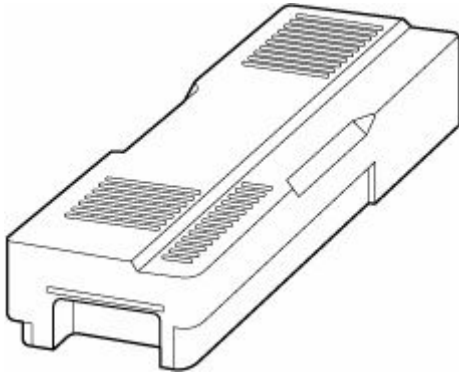

Absorbs ink used for cleaning.

➔ [Replacing the Maintenance Cartridge](#)

▶▶▶ Important

- When purchasing, check the Model number.

Back / Side

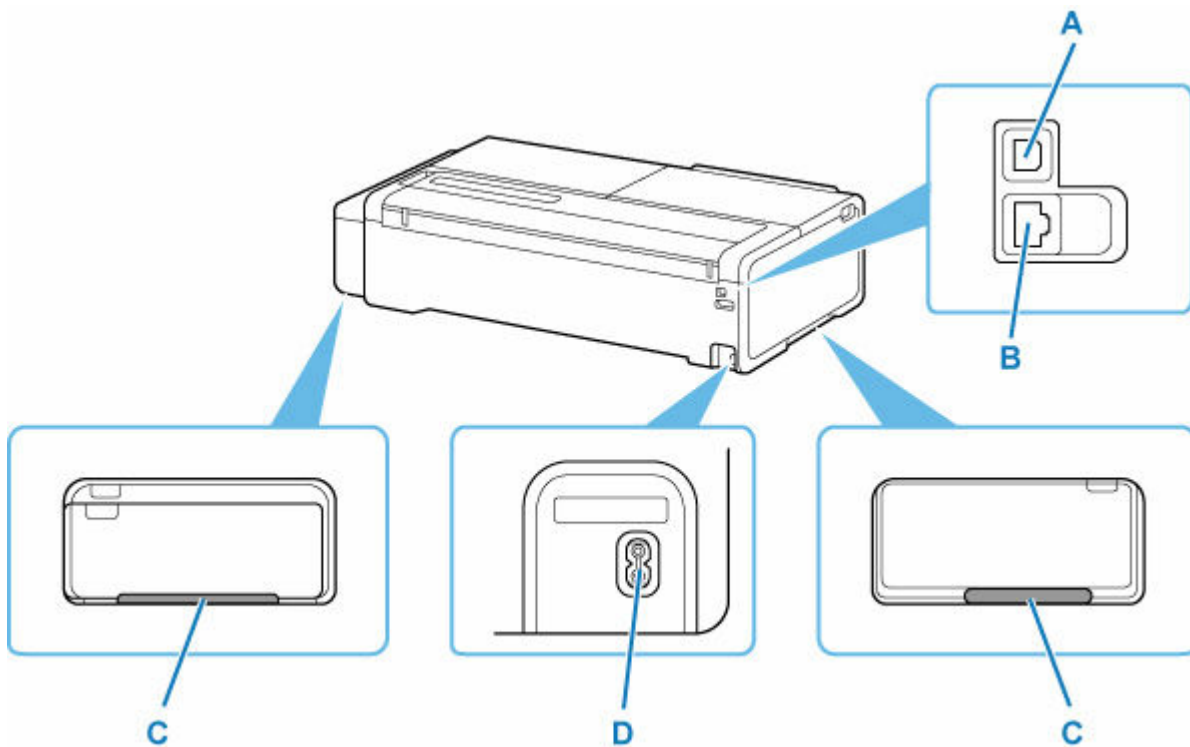

A: USB Port

Plug in the USB cable to connect the printer with a computer.

B: Wired LAN Connector

Plug in the LAN cable to connect the printer to a LAN.

C: Carrying Grips

When carrying the printer, have 2 people hold it by these handles under both sides. Furthermore, hold the left and right of these parts when moving the printer with a stand.

D: Power Cord Connector

Plug in the supplied power cord.

Top View

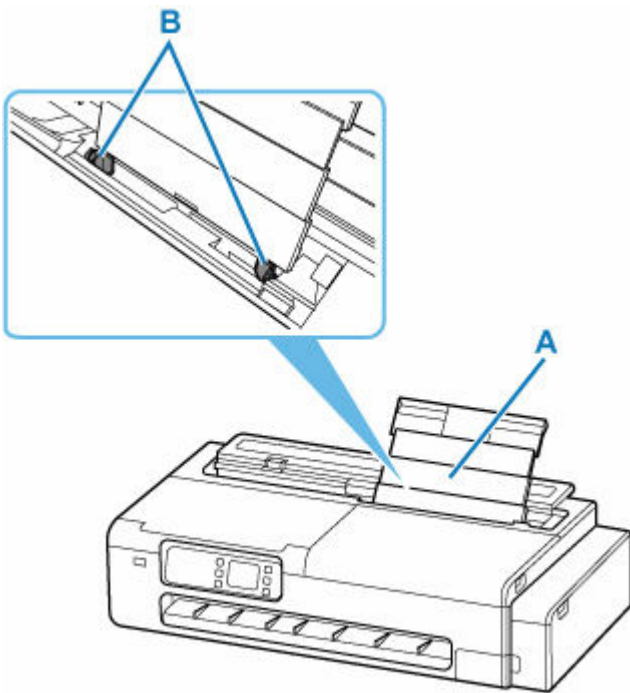

A: Top Feed

Load paper here. When loading sheets, open the top feed and then pull it upwards. Two or more sheets of the same size and type of paper can be loaded at the same time, and fed automatically one sheet at a time.

➔ [Loading Sheets in the Printer](#)

B: Paper Guides

Align with both sides of the paper stack.

Top View (with roll loaded)

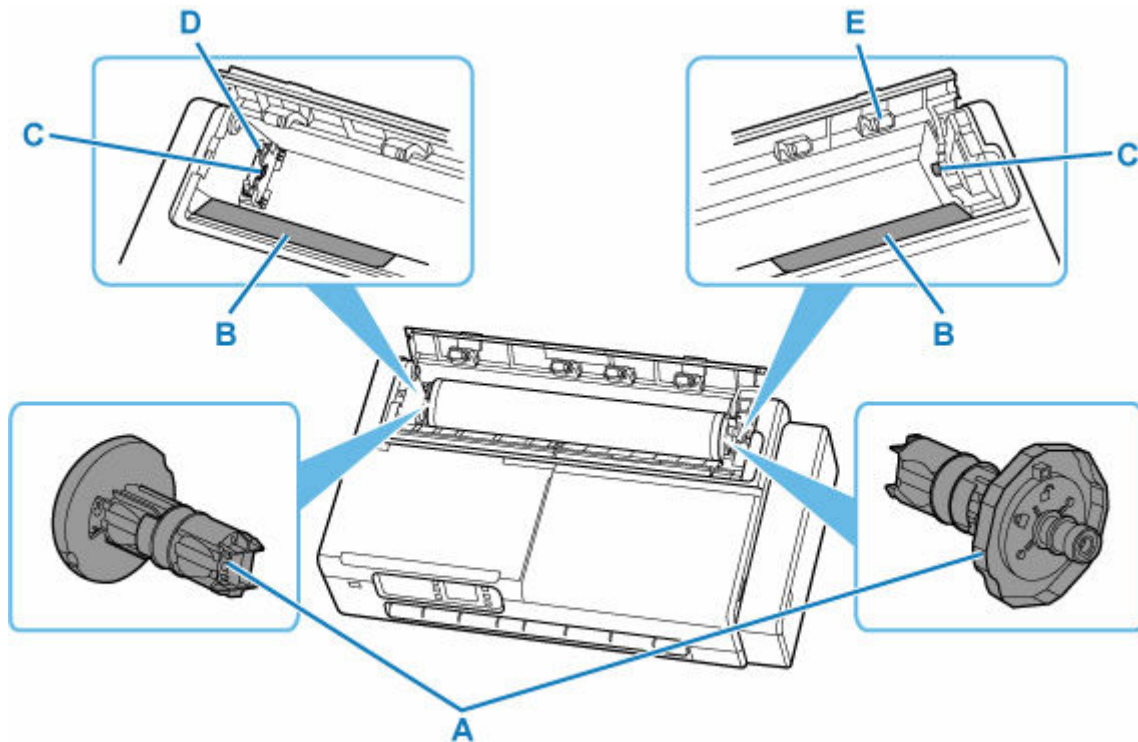

A: Roll Holder

When the roll is loaded into the printer, it is attached and secured on either side of the roll paper.

➔ [Loading Rolls in the Printer](#)

B: Slide Guide

Slide the roll holder over this guide to load the roll into the printer.

C: Roll Holder Slot

The roll holder shafts mounted on either side of the roll are set in these slots.

D: Roll Holder Support

Move this left or right when changing the width of the roll to be set.

➔ [Moving the Roll Holder Support](#)

E: Feed Cover Rollers

When feeding roll paper, these rollers help carry the paper to the paper retainer.

Inside

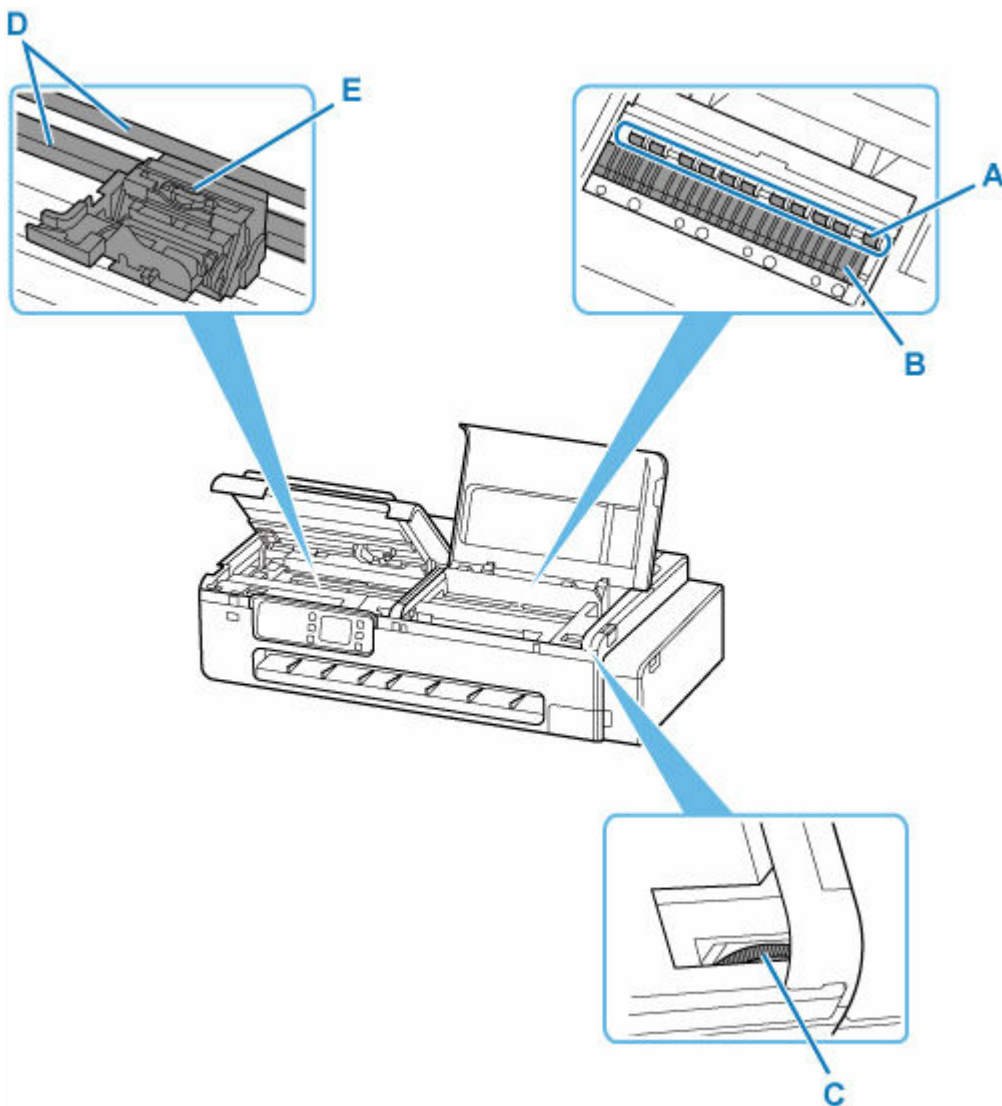

A: Paper Retainer

This retainer holds paper as it is fed.

B: Platen

The print head moves across the platen to print.

C: Ink Valve Lever

Use when the printer is sent for repair.

➔ [Repairing Your Printer](#)

D: Carriage Rail

The Carriage slides along this rail.

E: Carriage

Moves the print head.

➔ [Carriage](#)

Carriage

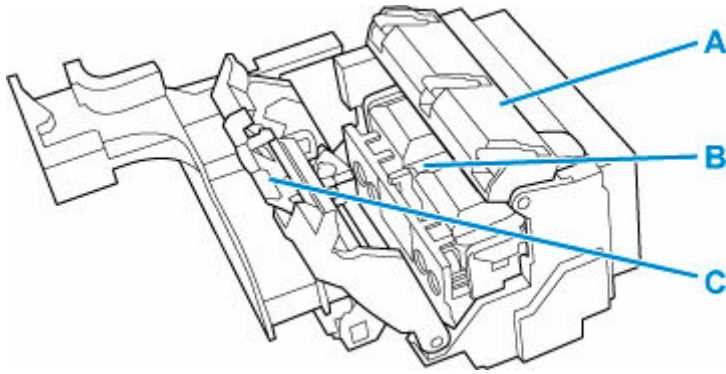

A: Print Head Locking Cover

Secures the print head.

B: Print Head

➔ [Print Head](#)

C: Print Head Lock Lever

Lock print head locking cover.

Print Head

Model number: PF-08

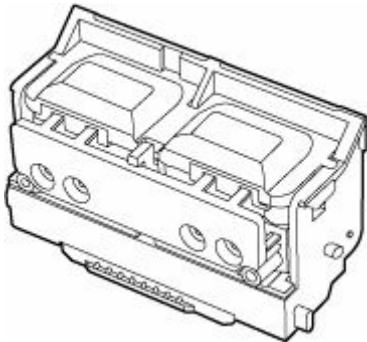

The print head is equipped with ink nozzles.

➔ [Replacing the Print Head](#)

➤➤ Important

- When purchasing, check the Model number.

Operation Panel

TC-20M

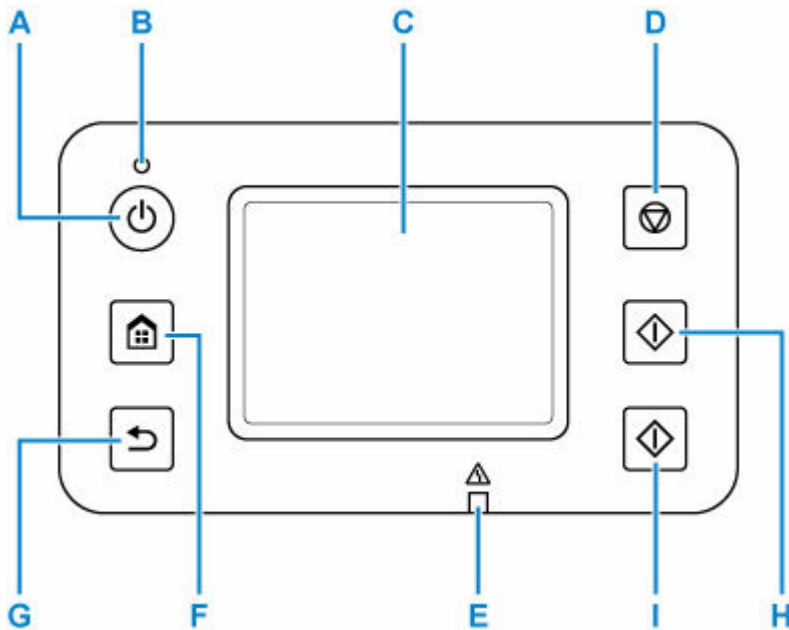

TC-20

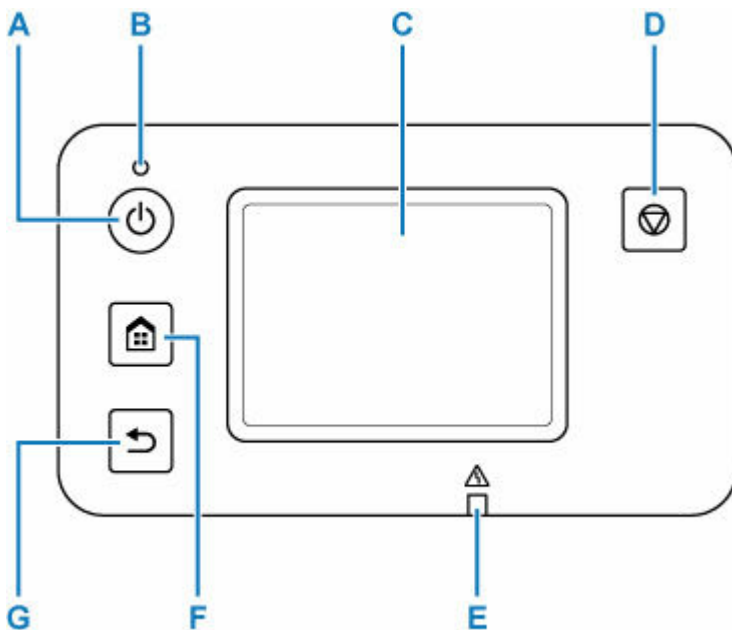

A: ON button

Turns the printer on or off. Lights after flashing when the power is turned on. Before turning on the power, make sure that the document cover is closed.

➔ [Turning the Printer On and Off](#)

B: ON lamp

Remains lit after flashing when the printer is turned on.

C: Touch Screen

Displays messages, menu items, and operating status. Touch the screen lightly with your finger to select a menu item or button.

➡ [Home Screen Menu Composition](#)

D: Stop button

Cancels printing, copying or scanning.

E: Alarm lamp

Lights up or flashes in case of errors.

F: HOME button

Used to display the HOME screen.

➡ [Home Screen Menu Composition](#)

G: Back button

Returns to the previous screen.

H: Black button (TC-20M)

Starts black-and-white copying or scanning.

I: Color button (TC-20M)

Starts color copying or scanning.

Desktop Basket

The following basket is available for this printer.

- Desktop Basket BU-06

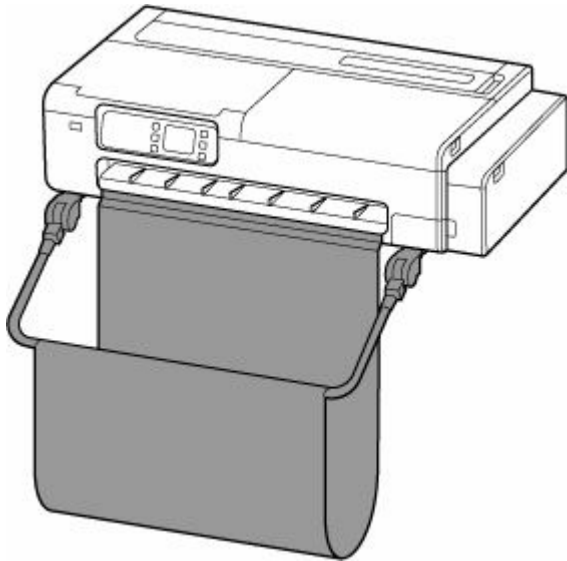

Parts of Desktop Basket

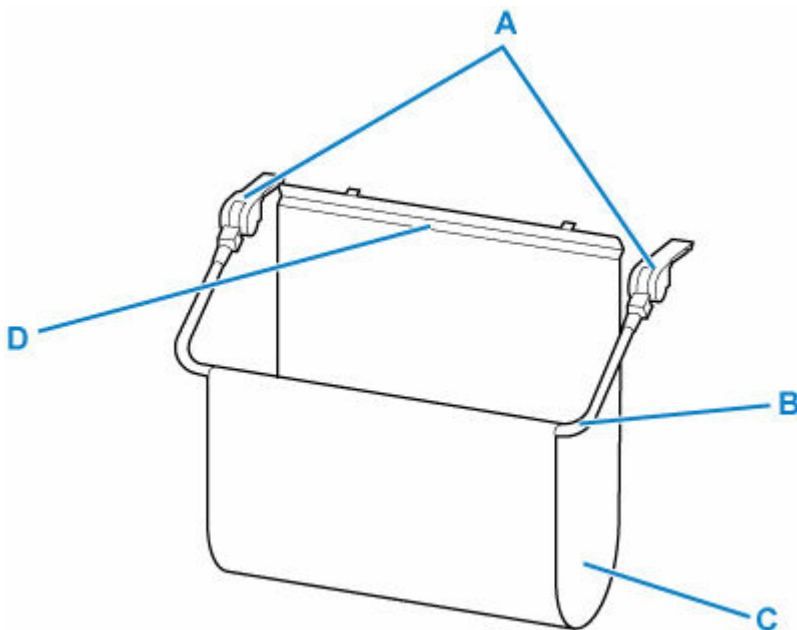

A: Basket Adapters

Insert these into the printer body to attach the Desktop Basket.

B: Basket Arm

Move the arm to open or close the basket.

C: Basket Cloth

Catches the ejected printed documents.

D: Support Stay

Attached in front of the output guide to support the basket cloth.

»» Note

- For instructions on how to use the Desktop Basket, see "[Using the Desktop Basket](#)".

Printer Stand

The following stand is available for this printer.

- Printer Stand SD-24

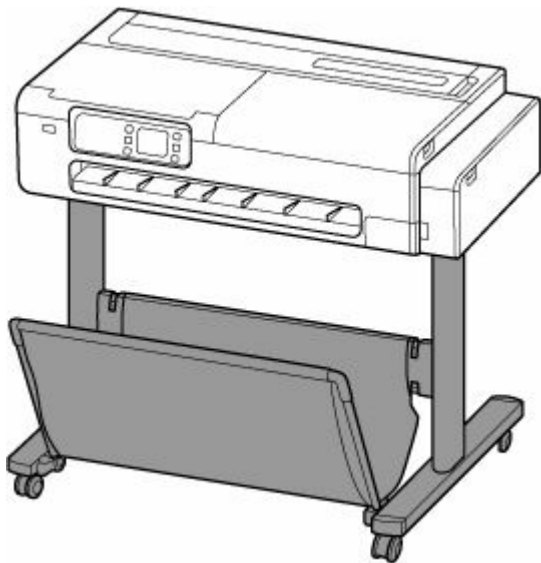

Parts of Printer Stand

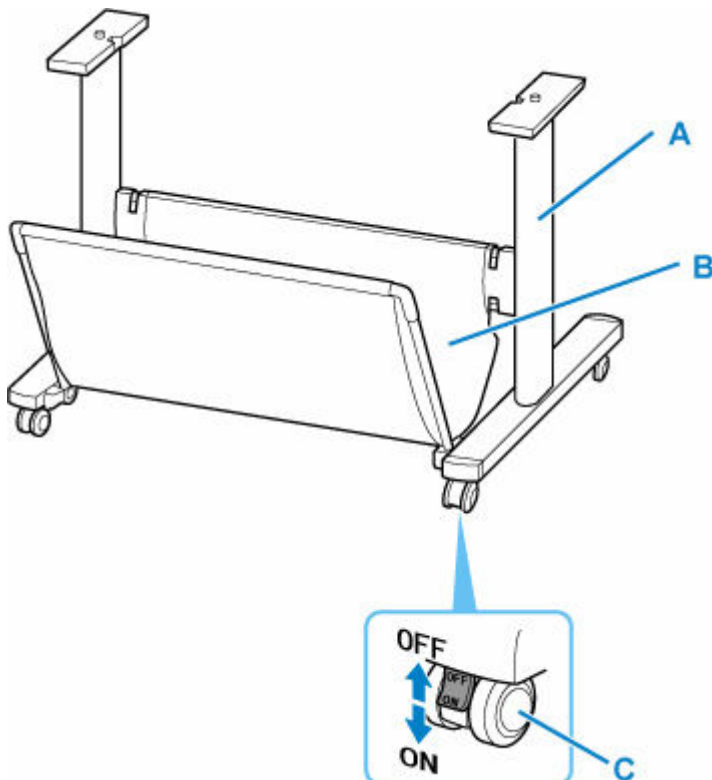

A: Stand

A stand that holds the printer. It is equipped with casters to facilitate movement.

B: Basket Cloth

Catches the ejected printed documents.

C: Locking Caster

The casters can be locked securely. When moving the printer, be sure to unlock the 4 casters. If you move it while the locking casters are locked, the floor may become scratched.

▶▶ Note

- For instructions on how to use the basket that comes with the printer stand, see "[Using the Basket on the Printer Stand](#)".

Using the Printer

- **Turning the Printer On and Off**
- **Loading Rolls in the Printer**
- **Loading Sheets in the Printer**
- **Using the Desktop Basket**
- **Using the Basket on the Printer Stand**
- **Stopping Printing**
- **Loading Originals on Document Platen**
 - Loading Originals Correctly for each Function

Turning the Printer On and Off

Turning on the printer

Press the **ON** button to turn on the printer.

The **ON** lamp flashes and then remains lit.

➔ [Checking that Power Is On](#)

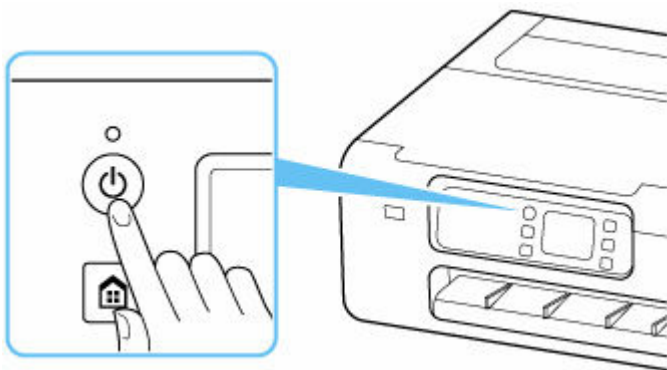

▶▶▶ Note

- It may take a while for the printer to start printing immediately after you turn on the printer.
- You can set the printer to automatically turn on when a print operation is performed from a computer connected by USB cable or wireless network. This feature is set to off by default.

➔ [ECO](#)

Turning off the printer

Press the **ON** button to turn off the printer.

When the **ON** lamp stops flashing, the printer is turned off.

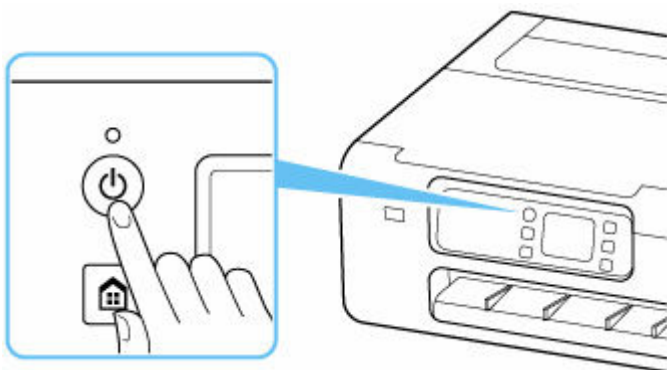

▶▶▶ Important

- When you unplug the power cord after turning off the printer, be sure to confirm that the **ON** lamp is off.

▶▶▶ Note

- You can set the printer to automatically turn off when no operations are performed or no print jobs are sent to the printer for a certain interval. This feature is set to on by default.

➔ [ECO](#)

Checking that Power Is On

The **ON** lamp is lit when the printer is turned on.

Even if the touch screen is off, if the **ON** lamp is lit, the printer is on.

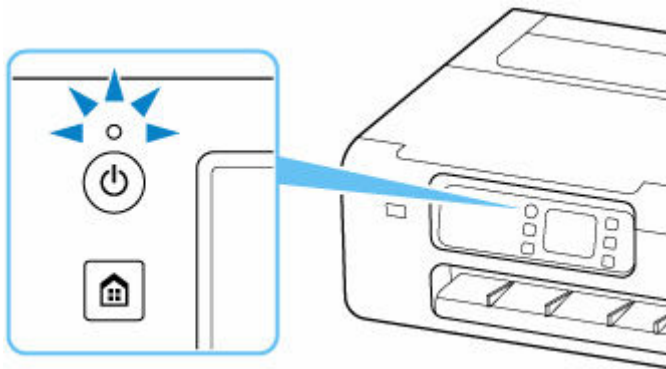

▶▶▶ Note

- The touch screen display will turn off if the printer is not operated for about 5 minutes. To restore the display, touch the touch screen. The display is also activated again when an original is printed from a computer.

Using the Desktop Basket

You can store printed documents in the basket.

When storing printed documents in the basket, use the basket in position (1).

When you are not using the basket, store it in position (2).

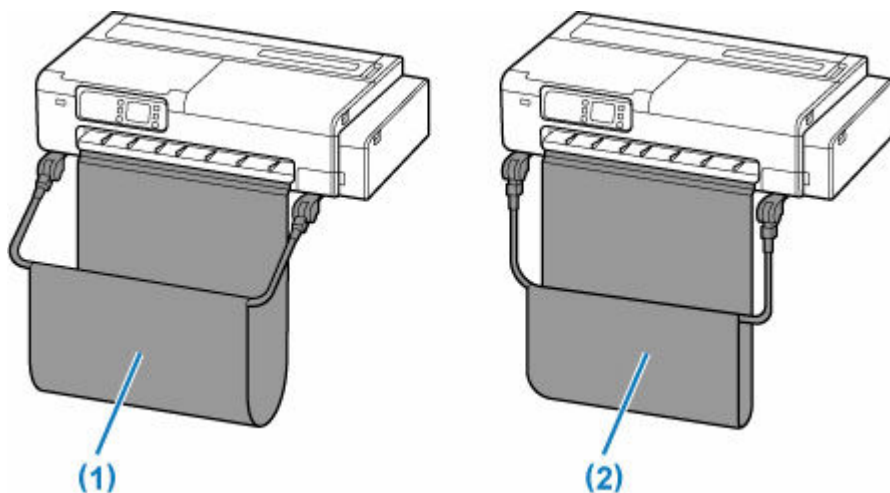

►► Important

- When storing printed documents on the basket, always use it in position (1). If you do not, printed documents may not be dropped into the basket, and the printed surface may become soiled.
- Lift the left and right sides of the basket arm (A) evenly so that the front of the basket is horizontal.

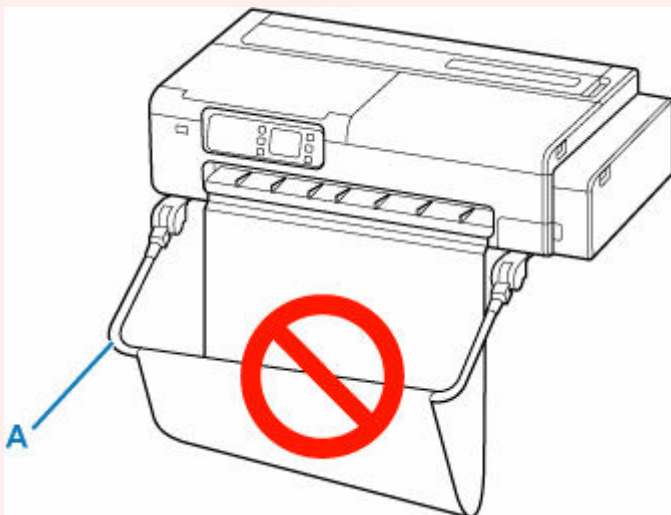

- The number of sheets that can be collected in the basket is one. If printing multiple pages, print after removing each sheet.
- The basket can hold printed documents from paper up to 36.0 inches (914.4 mm) long.
- Printed documents that are short in length relative to the roll paper width may not fall straight down and miss the basket. For short printed documents, it is recommended to use **Eject cut**.

➔ [Eject cut \(when the paper surface is being scratched / to wait for ink to dry\)](#)

- If the cloth part of the basket becomes dirty, wipe off the dirt without washing. Washing it may affect the performance of the basket.

Using the Basket on the Printer Stand

You can store printed documents in the basket.

When storing printed documents in the basket, use the basket in position (1).

When you are not using the basket, store it in position (2).

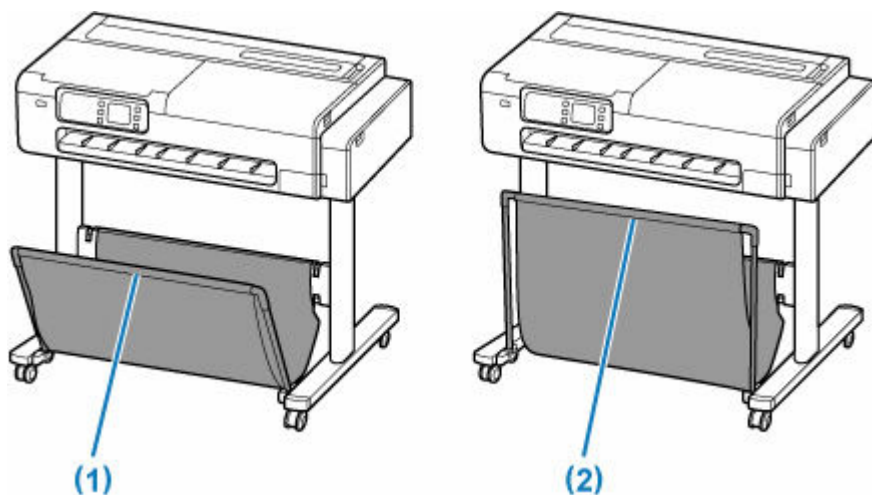

►► Important

- When storing printed documents on the basket, always use it in position (1). If you do not, printed documents may not be dropped into the basket, and the printed surface may become soiled.
- To store printed documents in the basket, first pull down the side rod (B) evenly so that the front rod (A) is not askew, and then use the basket.

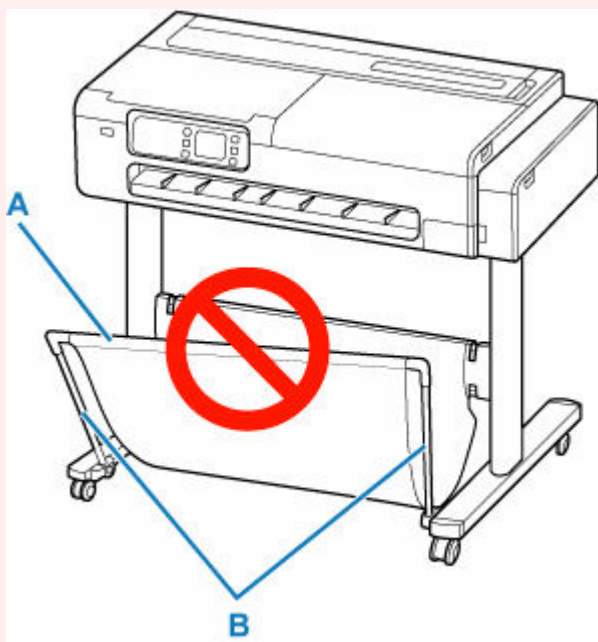

- The number of sheets that can be collected in the basket is one. If printing multiple pages, print after removing each sheet.
- The basket can hold printed documents from paper up to 48 inches (1219.2 mm) long.

- When moving the stand, make sure that the basket does not graze the floor and that all four of the casters are unlocked before moving the stand. Not doing so may damage the basket, scratch the floor, or cause injuries.
- If the cloth part of the basket becomes dirty, wipe off the dirt without washing. Washing it may affect the performance of the basket.

Stopping Printing

To cancel printing or reception of print jobs, press the **Stop** button on the operation panel.

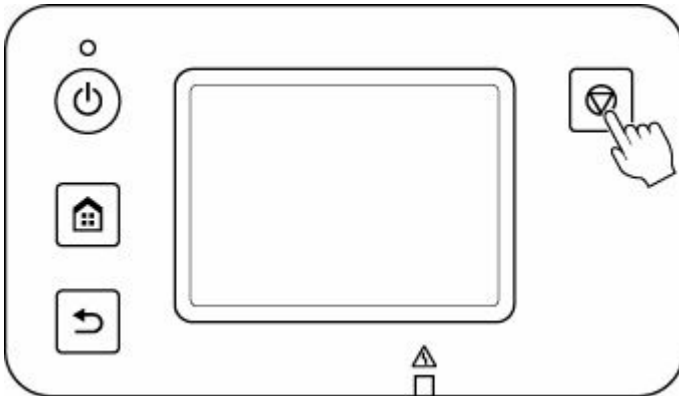

When you press the **Stop** button during printing, the printer operation varies depending on the current status.

- **You press the Stop button before printing starts**
The print job is canceled.
- **You press the Stop button during printing**
Printing stops immediately.

»» Important

- If you press the **ON** button while printing is in progress, the print data sent from the computer queues in the printer and you may not be able to continue to print. Press the **Stop** button to cancel printing.

Loading Originals on Document Platen

This function is available only for TC-20M.

You can load originals that meet the following conditions to the printer.

Item	Details
Types of originals	Text document, magazine, or newspaper Printed photo, postcard, business card, or disc (BD/DVD/CD, etc.)
Size (width x height)	Max. 8.5 x 11.7 in. (216 x 297 mm)

1. Open the document cover.

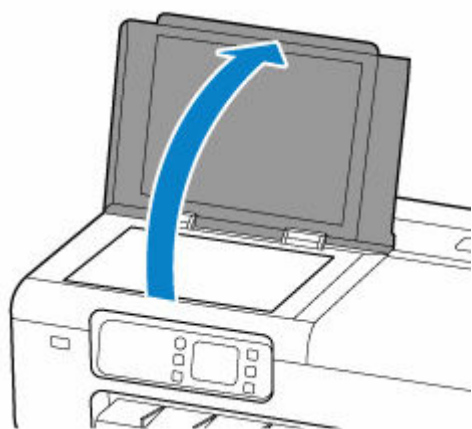

2. Load original with side to scan facing down on document platen.

➔ [Loading Originals Correctly for each Function](#)

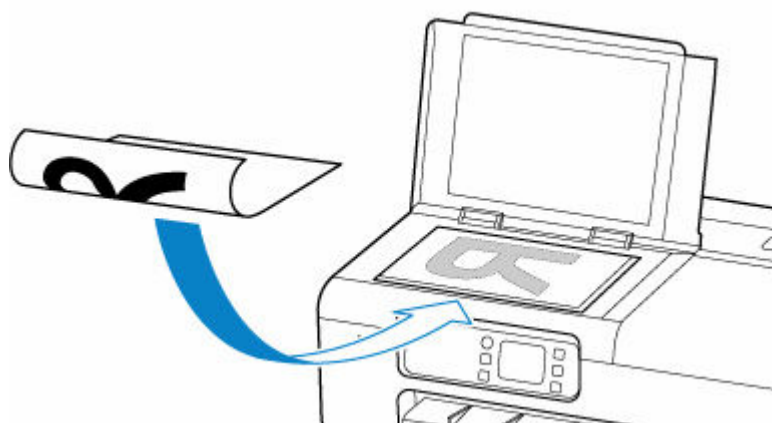

Important

- Be sure to observe the following when loading the original on the document platen.
Failure to observe the following may cause the scanner to malfunction or the platen glass to break.
 - Do not place any objects weighing 4.4 lb (2.0 kg) or more on the platen glass.

- Do not put any pressure of 4.4 lb (2.0 kg) or more on the platen glass, such as pressing down the original.
- Make sure any liquids on documents, such as glue, ink, or correction fluid are dry before loading.

3. Close the document cover gently.

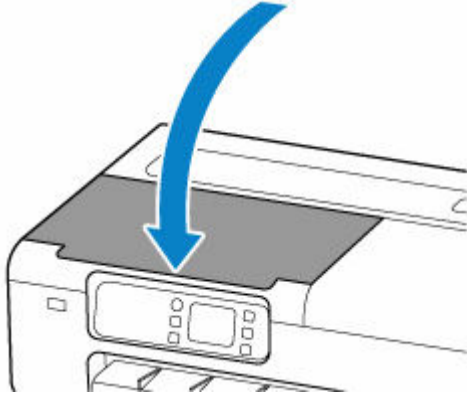

»» Important

- After loading the original on the document platen, be sure to close the document cover before starting to copy or scan.

Loading Originals Correctly for each Function

This function is available only for TC-20M.

Load the original in the correct position according to the function to use. If you do not load the original correctly, it may not be scanned properly.

Originals	Function	How to Load
Magazines, Newspapers, and Documents	Copying	➔ Loading the Original to Be Aligned with the alignment mark
	Scanning by specifying a standard size (A4, Letter, etc.) If you scan using the operation panel, select Document or Photo for Doc.type in Scan and specify a standard size (A4, Letter, etc.) for Scan size to scan originals.	
Photos, Postcards, Business Cards, and Disc (BD/DVD/CD)	Scanning only one original If you scan using the operation panel, follow the operation below. <ul style="list-style-type: none"> • Select Photo for Doc.type in Scan and specify Auto scan for Scan size to scan originals. 	➔ Loading Only One Original in Center of Document Platen
	Scanning two or more originals If you scan using the operation panel, follow the operation below. <ul style="list-style-type: none"> • Select Photo for Doc.type in Scan and specify Auto multi scan for Scan size to scan two or more originals. 	➔ Loading Two or More Originals on Document Platen

▶▶▶ Note

- For details on how to scan from the computer and how to load originals, see below.
 - For Windows:
 - ➔ [Scanning in Windows](#)
 - For macOS:
 - ➔ [Scanning in macOS](#)

Loading the Original to Be Aligned with the alignment mark

Place the original with the side to scan facing down on the Document Platen and align it with the alignment mark . Portions placed on the diagonally striped area cannot be scanned.

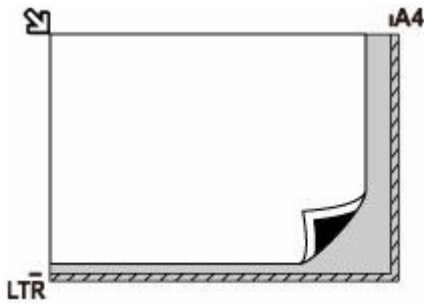

▶▶▶ Important

- The printer cannot scan the striped area (A) (0.04 in. (1 mm) from the edges of the platen glass).

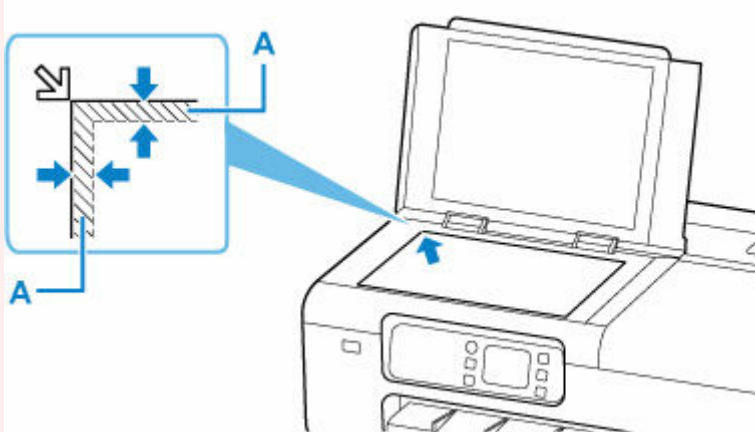

Loading Only One Original in Center of Document Platen

Place the original with the side to scan facing down, with 0.40 in. (1 cm) or more space between the edges (diagonally striped area) of the document platen. Portions placed on the diagonally striped area cannot be scanned.

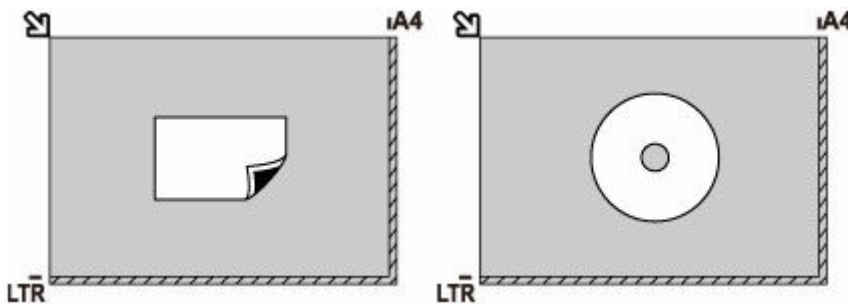

Loading Two or More Originals on Document Platen

Place the originals with the side to scan facing down. Allow 0.40 in. (1 cm) or more space between the edges (diagonally striped area) of the document platen and the originals, and between the originals. Portions placed on the diagonally striped area cannot be scanned.

You can place up to 12 items.

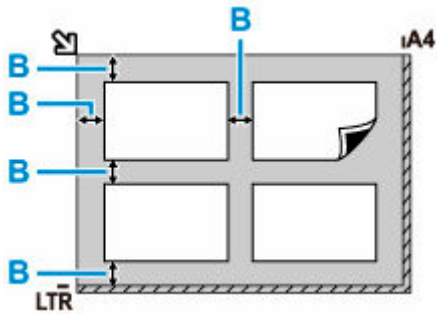

B: More than 0.40 in. (1 cm)

➤➤ Note

- The Skew Correction function automatically compensates for the originals placed at an angle of up to approximately 10 degrees.
- Non-rectangular or irregular shaped photos (such as cut out photos) may not be scanned properly.

Printing

▶ **Printing from Your Computer (Windows)**

- Printing with Easy Setup 📄 **Basics**
 - Changing the Type of Paper
- Printing Photos and Business Documents
 - Printing By Setting Print Purpose
 - Edit in PosterArtist and Print
- Scaled Printing
- Printing to Oversized Paper Sizes
- Setting Paper Dimensions (Custom Size)
- Printing Hanging and Horizontal Banners (Large-Format Printing)
- See more...

▶ **Printing from Computer (macOS)**

- Printing with Easy Setup 📄 **Basics**
 - Changing the Type of Paper
- Scaled Printing
- Printing to Oversized Paper Sizes
- Setting Paper Dimensions (Custom Size)
- Print Area
- Printing Hanging and Horizontal Banners (Large-Format Printing)
- See more...

▶ **Printing from Computer (Chrome OS)**

▶ **Printing from Printer**

- Printing Photographs Saved on USB Flash Drive
- Printing Documents (PDF) Saved on USB Flash Drive

▶ **Printing from Smartphone/Tablet**

- Print Easily from a Smartphone or Tablet with Canon PRINT Inkjet/SELPHY

- Printing from iOS Device (AirPrint)
- Printing with Mopria Print Service
- Printing with Canon Print Service

▶ **Using PIXMA/MAXIFY Cloud Link**

Printing from Your Computer (Windows)

- **Printing with Easy Setup** 📌 **Basic**
- **Setting the Number of Copies and Printing Order**
- **Printing Photos and Business Documents**
- **Printing CAD Drawings**
- **Changing the Print Quality and Correcting Image Data**
- **Scaled Printing**
- **Printing to Oversized Paper Sizes**
- **Setting Paper Dimensions (Custom Size)**
- **Printing Hanging and Horizontal Banners (Large-Format Printing)**
- **Printing by Dividing/Joining Documents**
- **Printing by Saving Roll Paper**
- **Switching the Paper Source to Match the Purpose**
- **Displaying the Print Results before Printing**
- **Other Convenient Settings**

Printing with Easy Setup

This section describes the simple setting procedure so that you can carry out appropriate printing on this printer.

Printing with Easy Setup

1. [Check that printer is turned on](#)
2. Load paper on the printer
Set [roll paper](#) or [cut sheet](#) to a printer.
3. Open the [printer driver setup window](#)
4. Select the media type

Select the type of paper loaded in the printer from the **Media Type** list on the **Main** tab.

If **Auto (Use Printer Settings)** is selected, the paper configured in printer settings is printed.

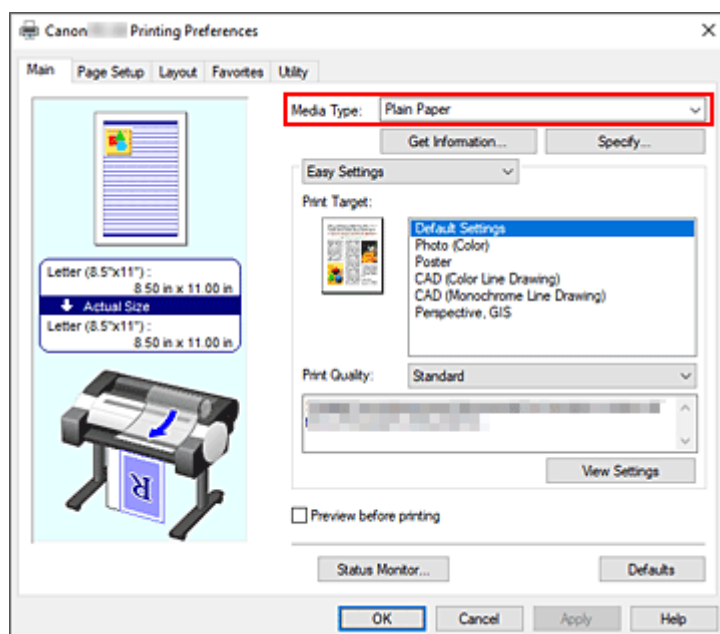

Important

- See "Paper Information List" for Canon authentic paper or Canon output check paper.

Note

- Click **Get Information...** to display the **Paper Information on Printer** dialog box. The **Paper Information on Printer** dialog box allows you to get the paper information from the printer and to set the paper source and the media type on the printer driver.
- For instructions on changing the media type from the printer's operation panel, see "[Changing the Type of Paper.](#)"

5. Select print target

From the pull-down menu, select **Easy Settings**, and then select the setting that matches your purpose from the **Print Target** list.

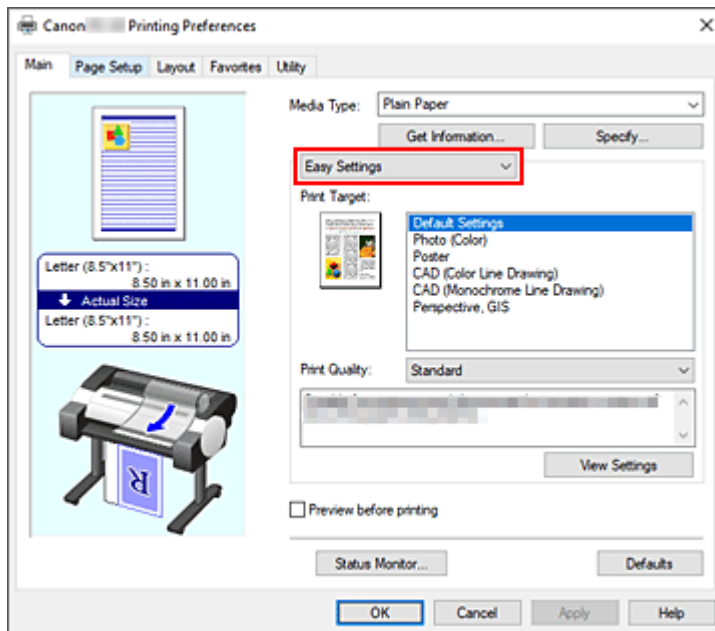

6. Select the print quality

For **Print Quality**, select **High**, **Standard** or **Draft** according to your purpose.

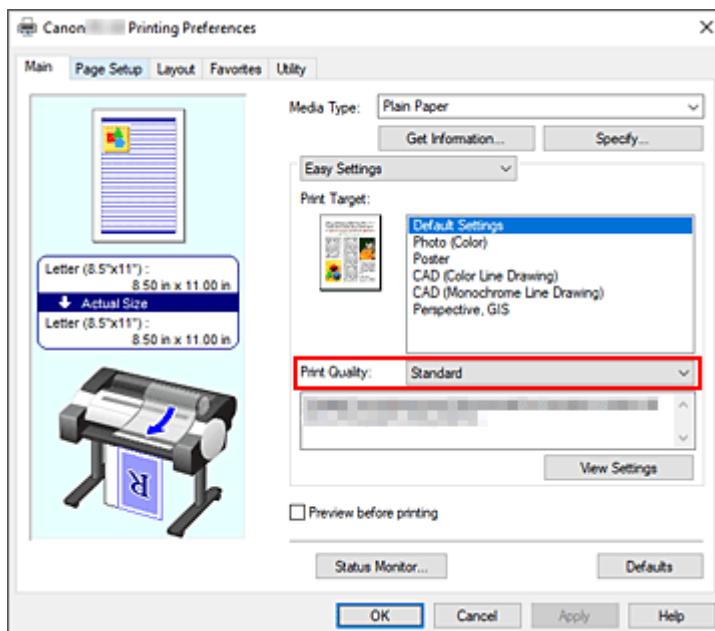

»»» Important

- The print quality settings that can be selected may differ depending on a printing profile.

7. Select the paper size

From the **Page Size** list on the **Page Setup** tab, select the same size as that of the document that was created with the application software.

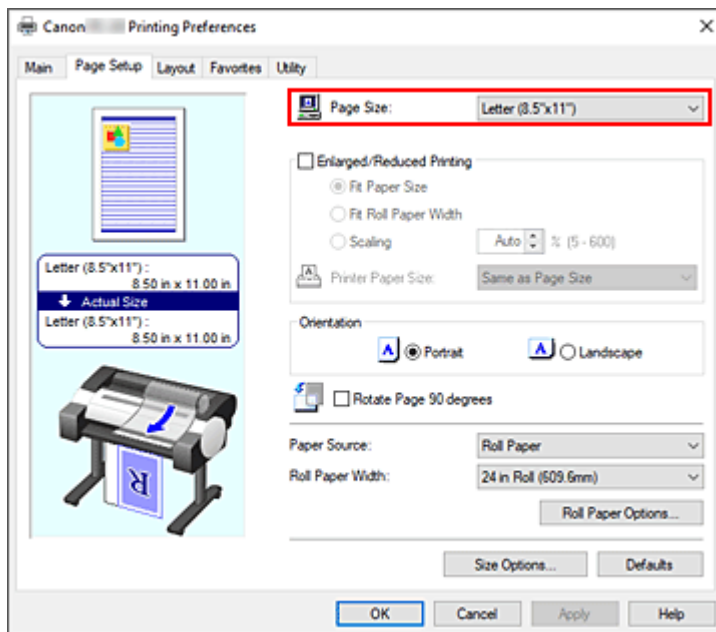

8. Select the paper source

For **Paper Source**, select the setting that matches your purpose.

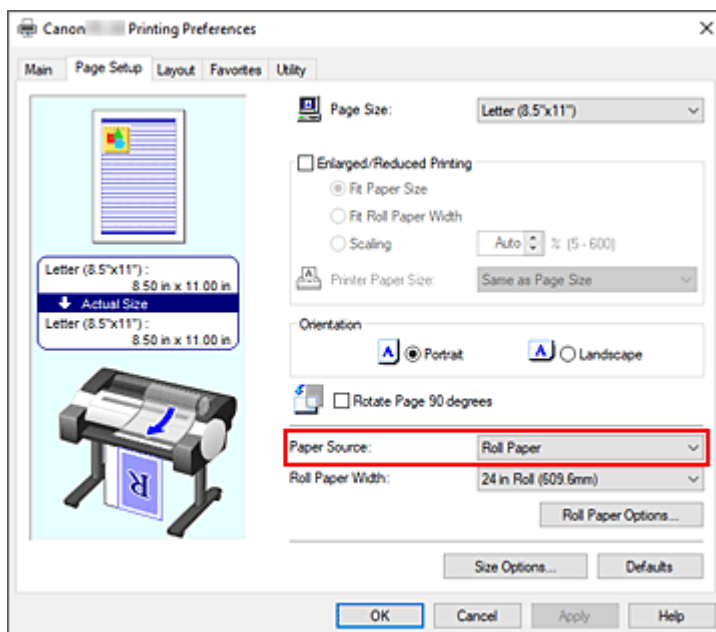

9. Select roll paper width

If you selected a roll paper for **Paper Source**, set **Roll Paper Width** to the width of the roll paper loaded in the printer.

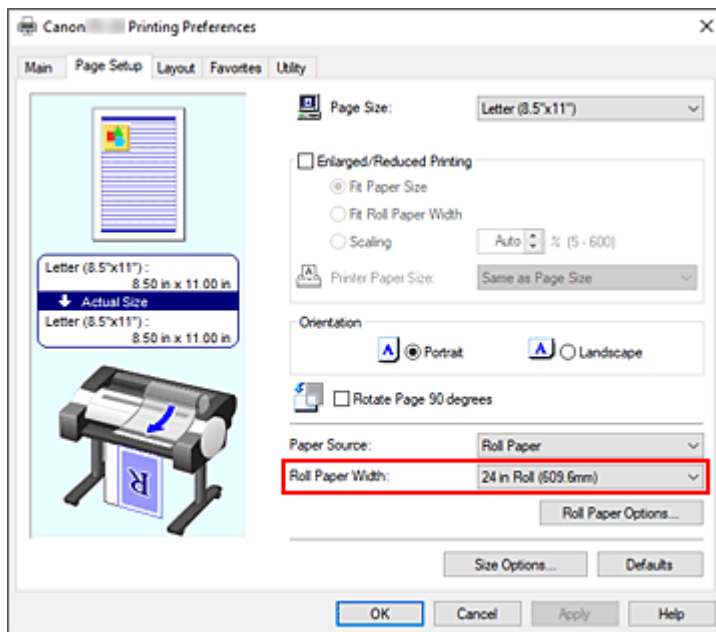

10. Complete the setup

Click **OK**.

When you print, the document is printed with settings that match your purpose.

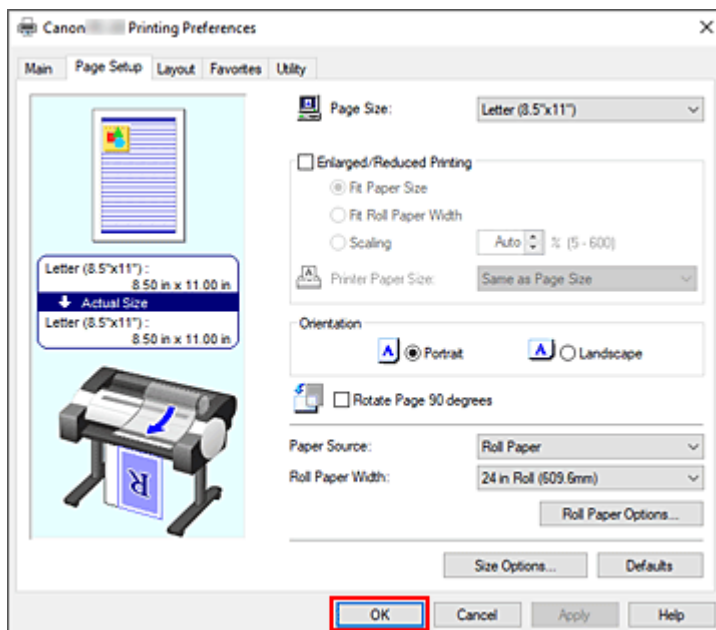

➤➤➤ Note

- If the paper settings in the printer driver differ from the paper information registered on the printer, an error message may appear on the printer's operation panel. You can execute Print, but you may not obtain the correct printing result.
- Under initial settings, **Print Priority** in **Advanced Settings** is set to **Line Drawing/Text**, so your print data will be printed with the appropriate density for line drawings.

Checking Printer Settings and Applying Settings to Printer Driver

1. Open printer driver setup window

2. Click **Get Information...** on **Main** tab

The **Paper Information on Printer** dialog box appears.

3. Select the paper source

From **Paper Source**, check the setting or select a new paper source.

The current printer settings appear in **Media Type** and **Roll Paper Width**.

4. Apply settings

To apply the printer settings to the printer driver, click **OK**.

▶▶▶ Note

- If the media type and the output paper size are not set on the printer, **OK** will be grayed out and cannot be clicked.
- If communication with the printer is disabled, the **Get Information...** does not appear or printer media information from the printer cannot be obtained.

Setting the Number of Copies and Printing Order

The procedure for specifying the number of copies and printing order is as follows:

1. Open the [printer driver setup window](#)
2. Specify the number of copies to be printed

For **Copies** on the **Layout** tab, specify the number of copies to be printed.

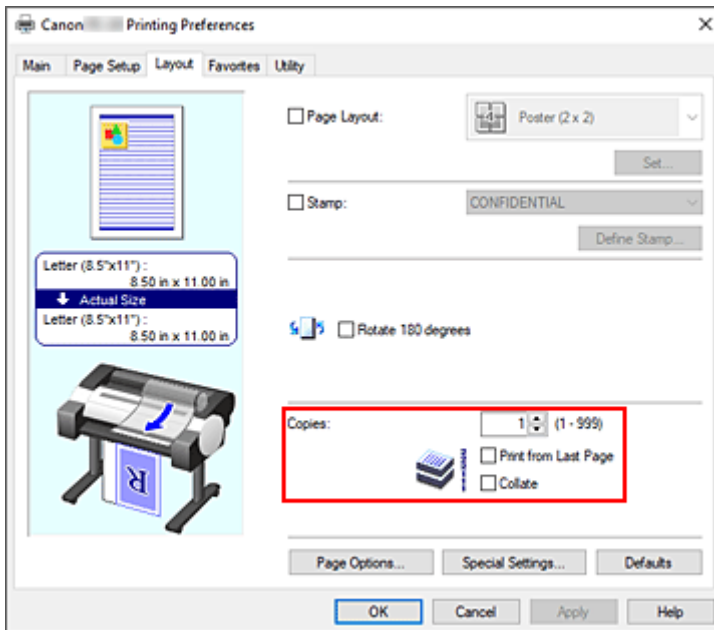

3. Specify the print order

Check the **Print from Last Page** check box when you want to print from the last page in order, and uncheck the check box when you want to print from the first page.

Check the **Collate** check box when you are printing two or more copies, and want to print them in groups, and uncheck the check box when you want to print them as a group on the same page.

4. Complete the setup

Click **OK**.

When you execute print, the specified number of copies will be printed with the specified printing order.

►► Important

- When the application software that you used to create the document has the same function, specify the settings on the printer driver. However, if the print results are not acceptable, specify the function settings on the application software. When you specify the number of copies and the printing order with both the application software and this printer driver, the number of copies may be multiplied numbers of the two settings or the specified printing order may not be enabled.

Printing Photos and Business Documents

- **Printing By Setting Print Purpose**
- **Edit in PosterArtist and Print**

Printing By Setting Print Purpose

The print settings that are generally used frequently are pre-registered as print purposes. By using a print purpose to print, you can print with settings that match the document.

The procedure for printing by using a print purpose is as follows:

1. Open the [printer driver setup window](#)
2. Select the media type

Select the type of paper loaded in the printer from the **Media Type** list on the **Main** tab.

If **Auto (Use Printer Settings)** is selected, the paper configured in printer settings is printed.

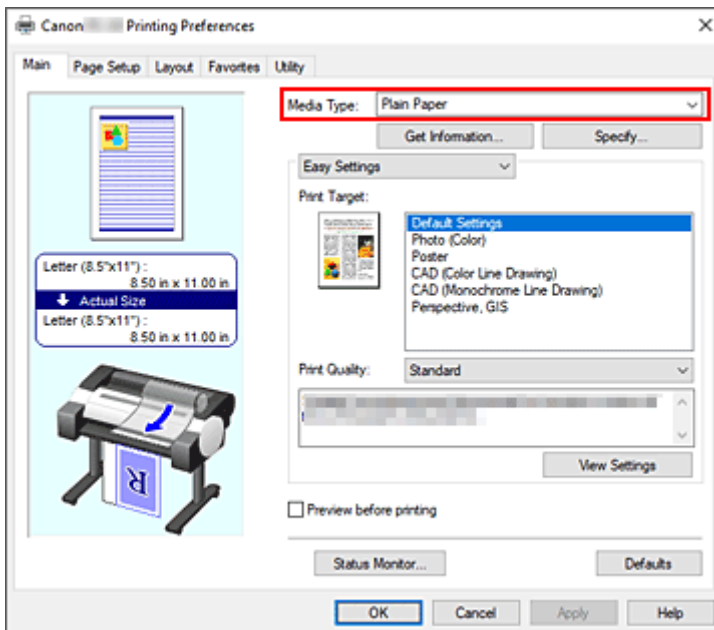

3. Select print setting mode

From the pull-down menu, select **Easy Settings**.

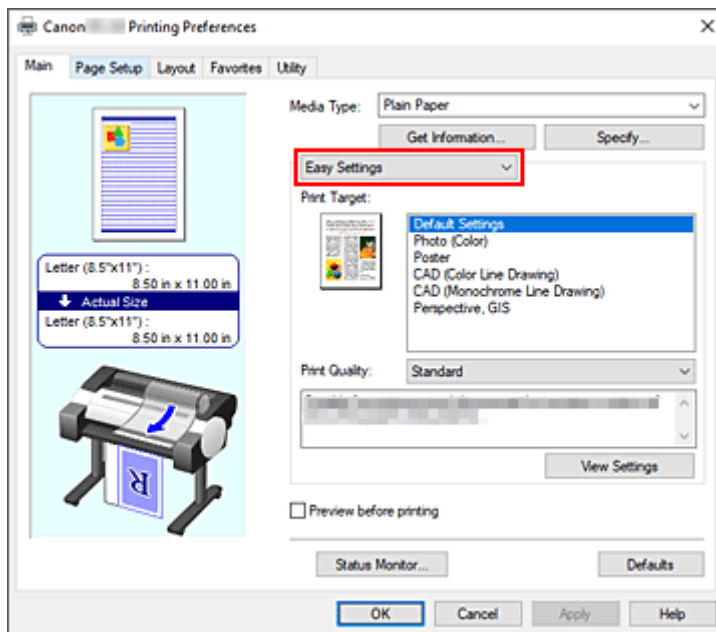

4. Select print purpose

For **Print Target**, select the setting that matches the document.

Default Settings

Select this when printing general documents such as business documents.

Photo (Color)

Select this when printing color illustrations or photos.

Poster

Select this when printing posters.

CAD (Color Line Drawing)

Select when printing data such as drawings.

CAD (Monochrome Line Drawing)

Select when printing data such as drawings in monochrome.

Perspective, GIS

Select when printing data such as perspectives and GIS.

▶▶▶ Note

- To check the settings of the items that are set by **Print Target**, click **View Settings**.

5. Select the paper size

From the **Page Size** list on the **Page Setup** tab, select the same size as that of the document that was created with the application software.

The current settings are displayed in the settings preview on the left side of the window.

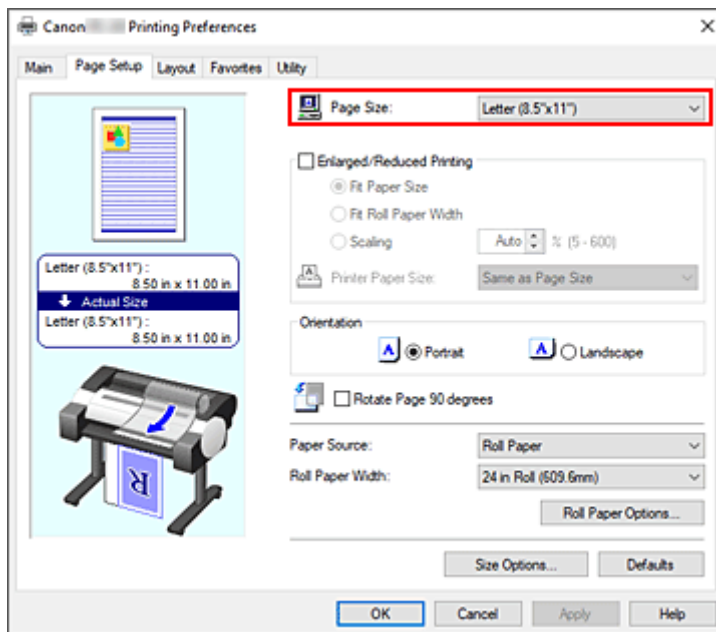

6. Select the paper source

For **Paper Source**, select the setting that matches your purpose.

7. Set the other items

Set the other items as necessary.

8. Complete the setup

Click **OK**.

When you print, the document is printed with settings to match the specified print purpose.

Edit in PosterArtist and Print

Word processing and spreadsheet software documents and web browser screens, etc. can be edited and printed from PosterArtist.

The following explains the procedure for editing original documents made in multiple application software in PosterArtist and printing in a poster layout.

1. Open the [printer driver setup window](#)

2. Select edit in PosterArtist

Check **Page Layout** in the **Layout** tab and select **Edit Using PosterArtist** from the pull-down menu.

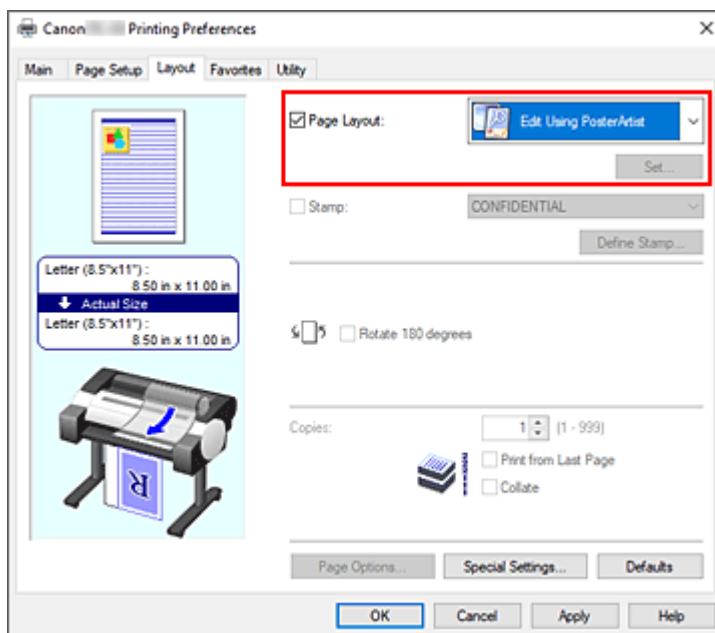

➤➤➤ Note

- **Edit Using PosterArtist** may not be available for use depending on the usage environment.

3. Start up PosterArtist

Click **OK**.

When printing is executed, PosterArtist starts up and PageCapture window opens.

4. Select page to get in PosterArtist

5. Edit page in PosterArtist

Image editing and sorting is implemented in PosterArtist.

By repeating steps 1 through 4 without closing the PosterArtist window, documents made in multiple application software can be arranged on one page.

After editing is complete, please print from PosterArtist menu.

»» Note

- For instructions on how to edit and rearrange images, refer to the PosterArtist manual.

Printing CAD Drawings

- ▶ **Printing By Setting Print Purpose**

Changing the Print Quality and Correcting Image Data

- **Adjusting Color Balance**
- **Setting the Print Quality Level (Custom)**
- **Printing a Color Document in Monochrome**
- **Specifying Color Correction**
- **Adjusting Brightness**
- **Adjusting Contrast**
- **Printing Using Detailed Setting Mode**

Adjusting Color Balance

You can adjust the color tints when printing.

Since this function adjusts color balance of the output by changing the ink ratios of each color, it changes the total color balance of the document. Use the application software when you want to change the color balance significantly. Use the printer driver only when you want to adjust the color balance slightly.

The following sample shows the case when color balance is used to intensify cyan and to diminish yellow so that the overall colors are more uniform.



No adjustment Adjust color balance

The procedure for adjusting color balance is as follows:

1. Open the [printer driver setup window](#)
2. Select the advanced settings

Select **Advanced Settings** from the pull-down menu on the **Main** tab.

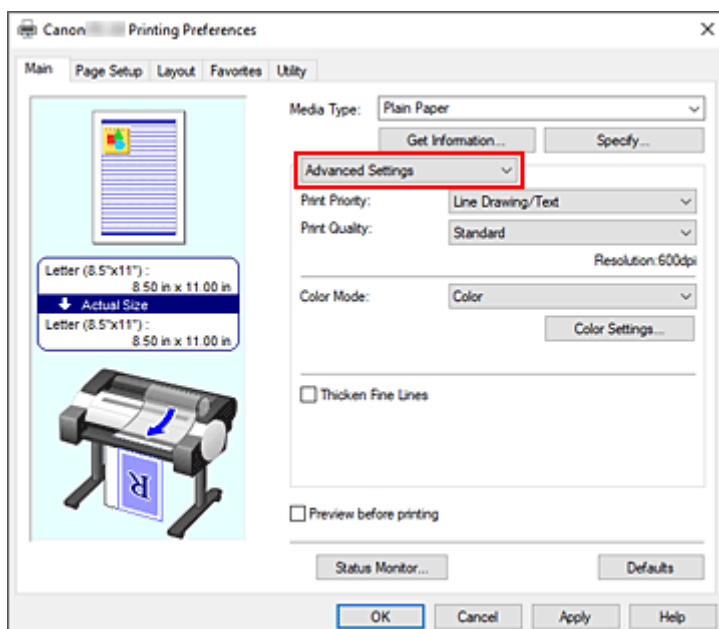

3. Select color mode

For **Color Mode**, select **Color**, and then click **Color Settings....**

The **Color Settings** dialog box appears.

4. Adjust color balance

The **Color Adjustment** tab has individual sliders for **Cyan**, **Magenta**, and **Yellow**. Each color becomes stronger when the corresponding slider is moved to the right, and becomes weaker when the corresponding slider is moved to the left. For example, when cyan becomes weaker, the color red becomes stronger.

You can also directly enter a value linked to the slider. Enter a value in the range from -50 to 50. The current settings are displayed in the settings preview on the left side of the printer driver.

After adjusting each color, click **OK**.

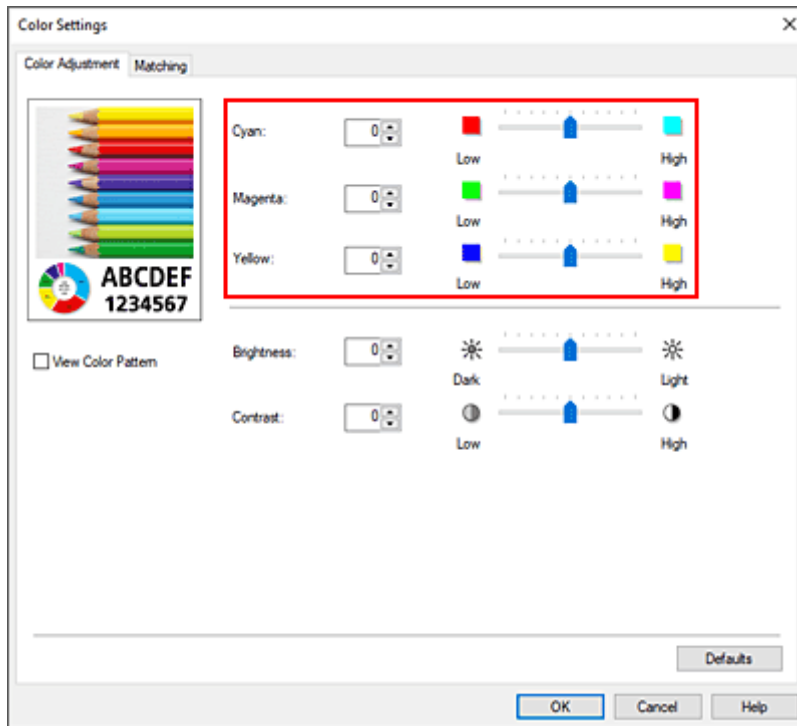

5. Complete the setup

Click **OK** on the **Main** tab.

When you execute print, the document is printed with the adjusted color balance.

Related Topics

- ➔ [Setting the Print Quality Level \(Custom\)](#)
- ➔ [Specifying Color Correction](#)
- ➔ [Adjusting Brightness](#)
- ➔ [Adjusting Contrast](#)

Setting the Print Quality Level (Custom)

Custom on the **Print Quality** tab allows you to set detailed print quality levels.

The procedure for setting the print quality level is as follows:

1. Open the [printer driver setup window](#)
2. Select advanced settings

From the **Main** tab pull-down menu, select **Advanced Settings**.

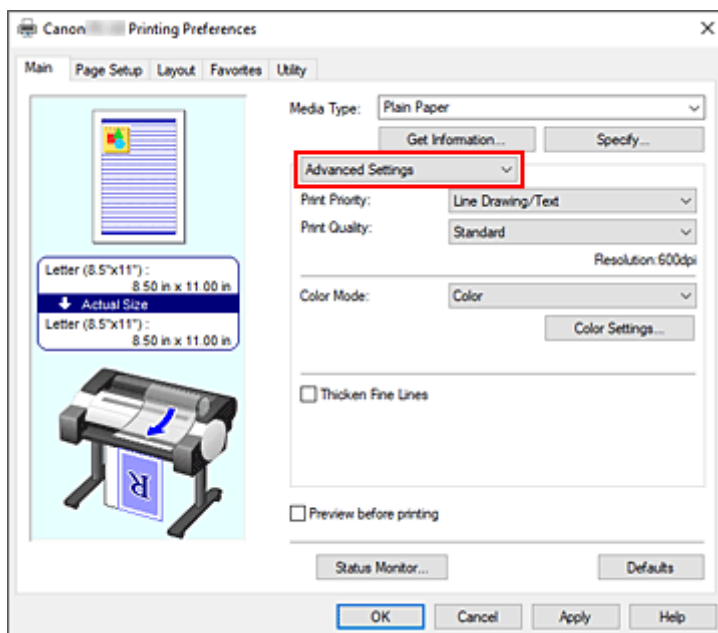

3. Select the print quality

For **Print Quality**, select **Custom**.

The **Custom** dialog box opens.

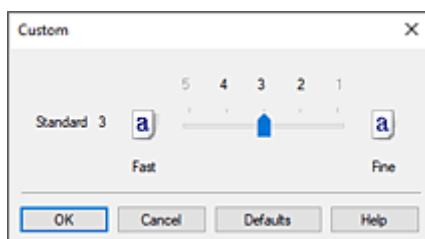

Important

- If **Auto (Use Printer Settings)** is selected for **Media Type**, **Custom** cannot be selected.

4. Setting the print quality level

Drag the slider bar to select the print quality level and click **OK**.

»» Important

- Certain print quality levels cannot be selected depending on the settings of **Media Type**.

5. Complete the setup

Click **OK** on the **Main** tab.

When you execute print, the image data is printed with the selected print quality level.

Related Topics

- ➔ [Specifying Color Correction](#)
- ➔ [Adjusting Color Balance](#)
- ➔ [Adjusting Brightness](#)
- ➔ [Adjusting Contrast](#)

Printing a Color Document in Monochrome

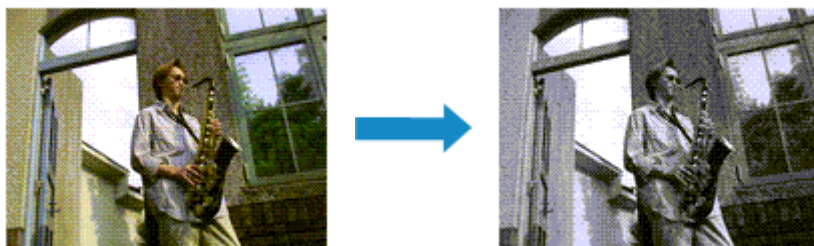

The procedure for printing a color document in monochrome is as follows:

1. Open the [printer driver setup window](#)
2. Select advanced settings

From the **Main** tab pull-down menu, select **Advanced Settings**.

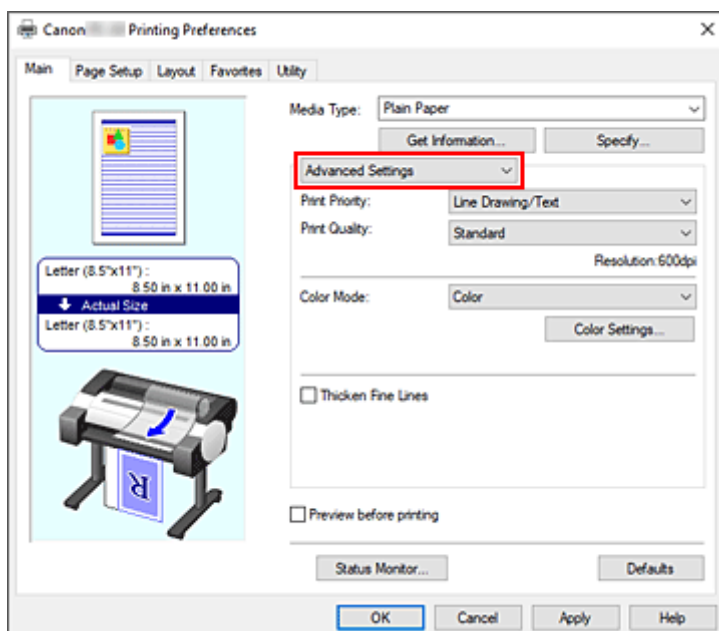

3. Select color mode

For **Color Mode**, select **Monochrome** or **Monochrome Bitmap**.

►►► Note

- The selectable **Color Mode** depends on the media type selected for **Media Type** on the **Main** tab.
- You can select **Monochrome Bitmap** for **Color Mode** only if **Line Drawing/Text** is selected in **Print Priority**.

4. Complete the setup

Click **OK**.

When you execute print, the document is converted to grayscale data. It allows you to print the color document in monochrome.

▶▶ Important

- When **Monochrome** or **Monochrome Bitmap** are selected, the printer driver processes image data as sRGB data. In this case, actual colors printed may differ from those in the original image data. When using the grayscale printing function to print Adobe RGB data, convert the data to sRGB data using an application software.

▶▶ Note

- When **Monochrome** or **Monochrome Bitmap** is selected, inks other than black ink may also be used.

Specifying Color Correction

You can specify the color correction method suited to the type of document to be printed. Normally, when data is printed, the printer driver automatically adjusts the colors.

When you want to print by using the color space of the image data effectively, select **ICM** or, **ICC Profile Matching**. When you want to use an application software to specify a printing ICC profile, select **Off**.

The procedure for specifying color correction is as follows:

1. Open the [printer driver setup window](#)
2. Select advanced settings

From the **Main** tab pull-down menu, select **Advanced Settings**.

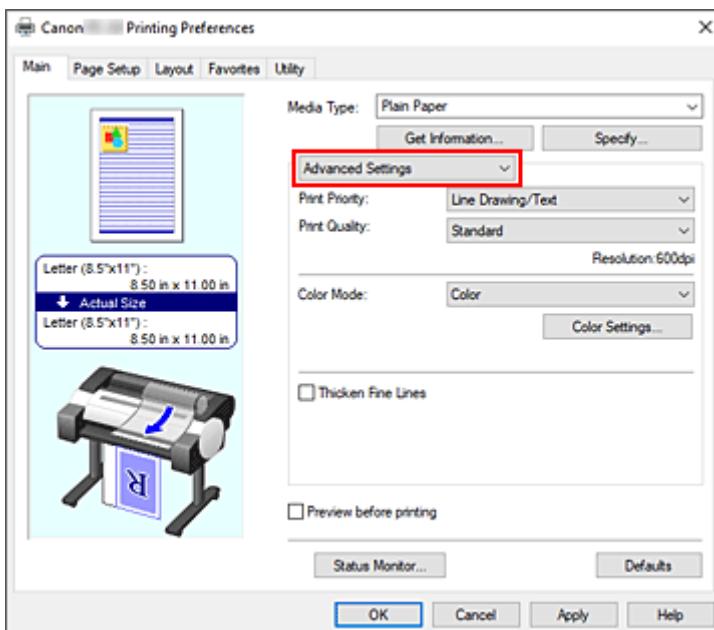

3. Select color mode

For **Color Mode**, select **Color**, and then click **Color Settings....**
The **Color Settings** dialog box appears.

4. Select color correction

Click **Matching** tab, select **Color Correction** setting that matches your purpose from the following, and click **OK**.

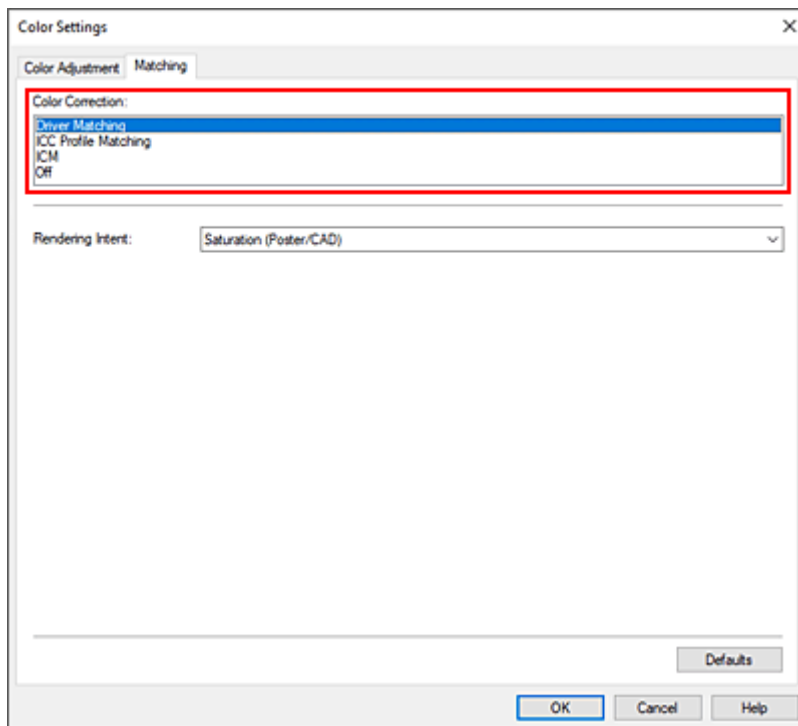

Driver Matching

Print with the optimal color using the printer driver's original color profile. Normally, you should choose this mode.

ICC Profile Matching

Carry out color matching using the ICC profile. Specify the input profile, printer profile and matching method in detail, and select when printing. You can use the digital camera or scanner ICC profile, or the ICC profile created using the profile creation tool.

ICM

Perform color matching on the host computer using the Windows ICM function. Select when printing from an ICM function-compatible application.

Off

Print without performing color matching on the printer driver. Select this when performing color matching using applications such as Adobe Photoshop, or printing a color chart using a profile creation tool.

5. Complete the setup

Click **OK** on the **Main** tab.

When you execute print, the document data is printed with the specified color correction.

»» Important

- When ICM is disabled in the application software, **ICM** is unavailable for **Color Correction** and the printer may not be able to print the image data properly.
- If **Auto (Use Printer Settings)** is selected for **Media Type**, the **Matching** sheet is not displayed, and color correction occurs according to printer settings.

Related Topics

- ➔ [Optimal Photo Printing of Image Data](#)
- ➔ [Adjusting Colors with the Printer Driver](#)
- ➔ [Printing with ICC Profiles](#)

Optimal Photo Printing of Image Data

When people print images taken with digital cameras, they sometimes feel that the printed color tones differ from those of actual image or those displayed on the monitor.

To get the print results as close as possible to the desired color tones, you must select a printing method that is best suited to the application software used or to your purpose.

Color Management

Devices such as digital cameras, scanners, monitors, and printers handle color differently. Color management (color matching) is a method that manages device-dependent "colors" as a common color space.

For Windows, a color management system called "ICM" is built into the operating system. sRGB is one of the common color spaces that is frequently used.

ICC profiles convert device-dependent "colors" into a common color space. By using an ICC profile and carrying out color management, you can draw out the color space of the image data within the color reproduction area that the printer can express.

▶▶▶ Note

- Normally, image files are saved in JPEG format. Some digital cameras allow you to save images in a format called RAW. RAW data refers to an image saving format that requires a computer to develop the image. You can embed an input ICC profile tag into a RAW file by using special application software.

Selecting a Printing Method Suited to the Image Data

The recommended printing method depends on the color space of the image data or the application software to be used.

There are two typical printing methods.

Check the color space of the image data and the application software to be used, and then select the printing method suited to your purpose.

[Adjusting Colors with the Printer Driver](#)

This section describes the procedure for printing data by using the color correction function of the printer driver.

Select this function when you want to print impressions that are close to those displayed on the monitor, for example, if you corrected the colors while checking the print image on the monitor.

[Printing with ICC Profiles](#)

Describes the procedure for printing by using the color space of the image data effectively.

You can print with a common color space by setting up the application software and the printer driver so that the color management matches the input ICC profile of the image data.

The method for setting up the printer driver differs depending on the application software to be used.

Adjusting Colors with the Printer Driver

To use printer driver matching when printing, turn on the printer driver's color correction function. Printer driver matching accurately applies the characteristics of data displayed on the monitor and allows you to obtain print results of impressions that are close to those displayed on the monitor.

▶▶▶ Important

- When printing using printer driver matching, Canon recommends that you set the monitor and the environment light as follows:
 - Monitor
 - Color temperature: D50 (5000K)
 - Brightness: 100 to 120cd/m²
 - Gamma: 2.2
 - Environment light
 - Fluorescent light for D50 color evaluation (color temperature 5000K, high color rendering properties)
 - Brightness when looking at printed materials: 500 lx ± 125 lx

▶▶▶ Note

- When printing from an application software that can identify ICC profiles and allows you to specify them, use a printing ICC profile in the application software, and select settings for color management.

The procedure for adjusting colors with the printer driver is as follows:

1. Open the [printer driver setup window](#)
2. Select advanced settings

From the **Main** tab pull-down menu, select **Advanced Settings**.

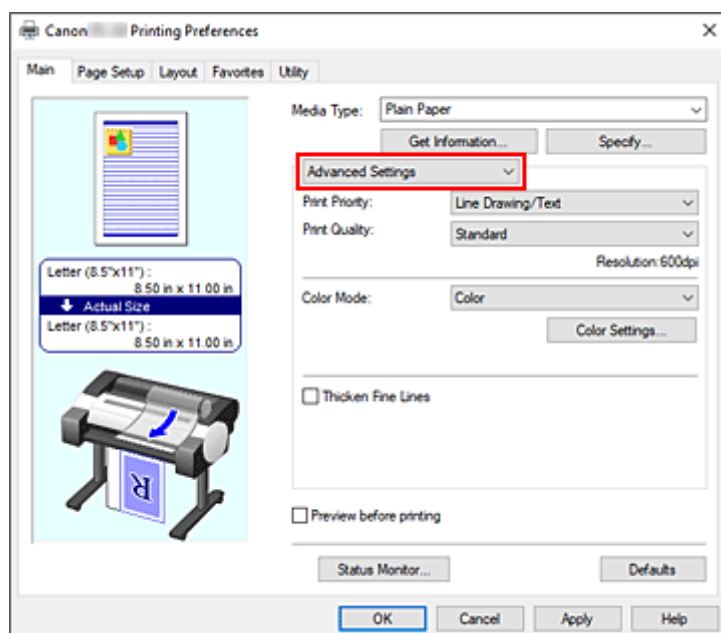

3. Select color mode

For **Color Mode**, select **Color**, and then click **Color Settings....**
The **Color Settings** dialog box appears.

4. Select color correction

Click **Matching** tab, and select **Driver Matching** for **Color Correction**.

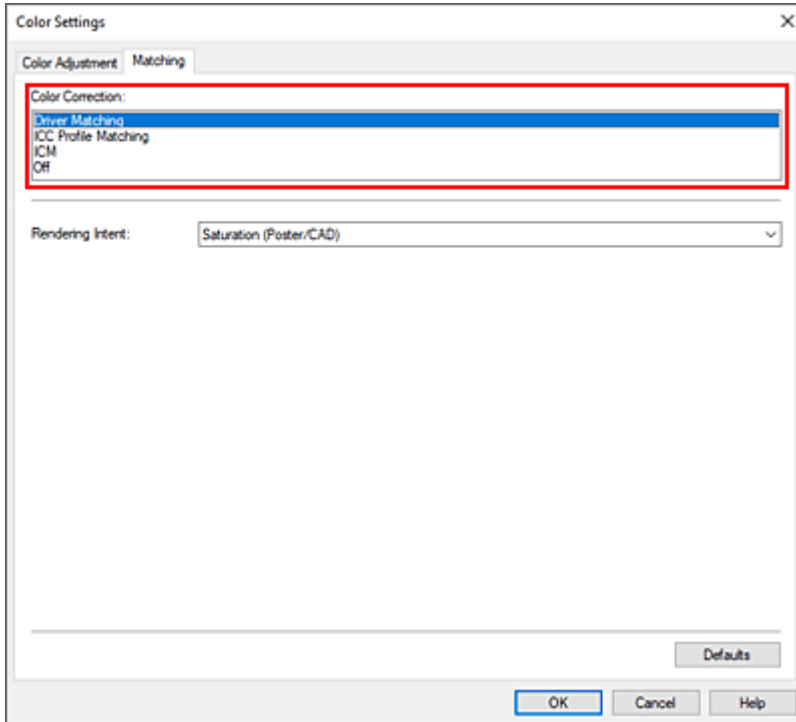

5. Select the rendering intent

Select the coloring adjustment method in **Rendering Intent**.

Perceptual (Photo)

Reproduces colors of general photos naturally and features smooth gradation. In addition, selecting this setting allows you to adjust colors easily using an application software.

Saturation (Poster/CAD)

Reproduces vivid colors on data such as a poster. In addition, prints in easy-to-see colors suitable for line drawing.

6. Set the other items

If necessary, click **Color Adjustment** tab, and adjust the color balance (**Cyan, Magenta, Yellow**) and adjust **Brightness**, and **Contrast** settings, and then click OK.

7. Complete the setup

Click **OK** on the **Main** tab.

When you print, the colors get adjusted by the printer driver when printing the data.

Related Topics

- ➔ [Setting the Print Quality Level \(Custom\)](#)
- ➔ [Specifying Color Correction](#)
- ➔ [Adjusting Color Balance](#)
- ➔ [Adjusting Brightness](#)
- ➔ [Adjusting Contrast](#)

Printing with ICC Profiles

When the image data has a specified input ICC profile, you can print by using the color space of the data effectively.

The printer driver setting procedure varies depending on the application software used to print.

Specify an ICC Profile from the Application Software and Print the Data

When you print the editing and touch-up results of Adobe Photoshop, Canon Digital Photo Professional, or any application software that allows you to specify input and printing ICC profiles, you print by effectively using the color space of the input ICC profile specified in the image data.

To use this printing method, use your application software to select color management items and specify an input ICC profile and a printing ICC profile in the image data.

Even if you print using a printing ICC profile that you created yourself, be sure to select color management items from your application software.

For instructions, refer to the manual of the application software you are using.

1. Open the [printer driver setup window](#)

2. Select advanced settings

From the **Main** tab pull-down menu, select **Advanced Settings**.

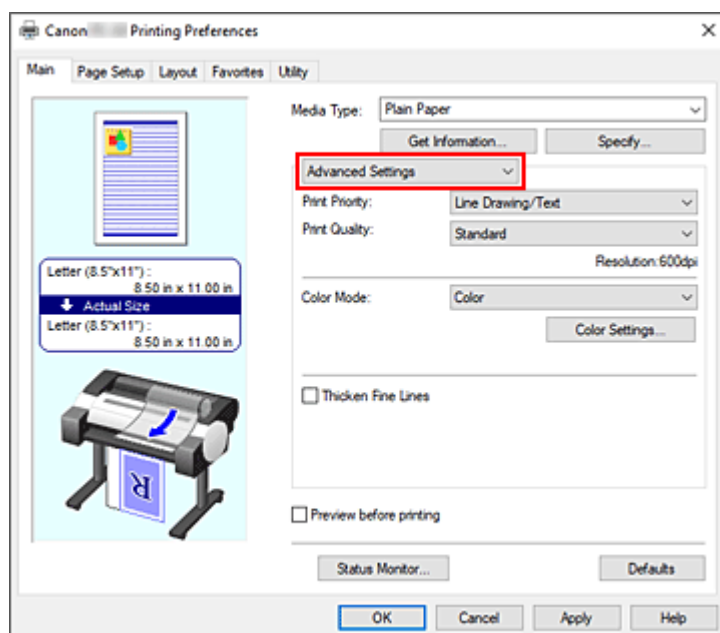

3. Select color mode

For **Color Mode**, select **Color**, and then click **Color Settings...**
The **Color Settings** dialog box appears.

4. Select color correction

Click **Matching** tab, and select **Off** for **Color Correction**.

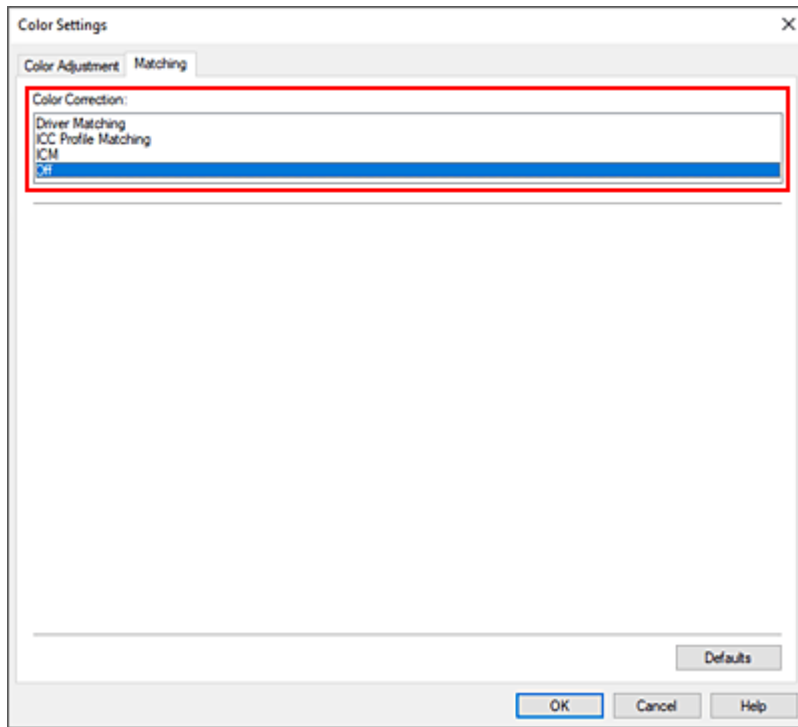

5. Set the other items

If necessary, click **Color Adjustment** tab, and adjust the color balance (**Cyan, Magenta, Yellow**) and adjust **Brightness**, and **Contrast** settings, and then click **OK**.

6. Complete the setup

Click **OK** on the **Main** tab.

When you execute print, the printer uses the color space of the image data.

Specify an ICC Profile with the Printer Driver, and then Print

When you print from application software that cannot identify input ICC profiles or does not allow you to specify one, the data color space is printed as sRGB.

1. Open the [printer driver setup window](#)

2. Select advanced settings

From the **Main** tab pull-down menu, select **Advanced Settings**.

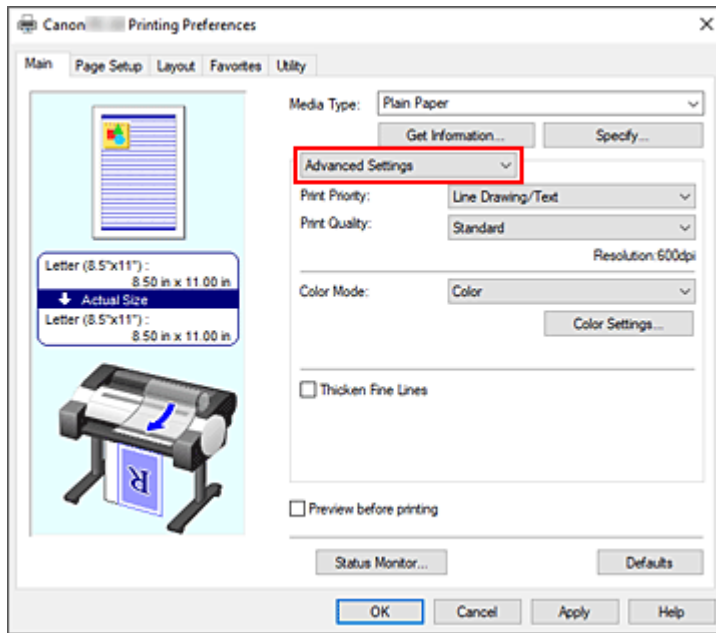

3. Select color mode

For **Color Mode**, select **Color**, and then click **Color Settings...**
The **Color Settings** dialog box appears.

4. Select color correction

Click **Matching** tab, and select **ICC Profile Matching** for **Color Correction**.

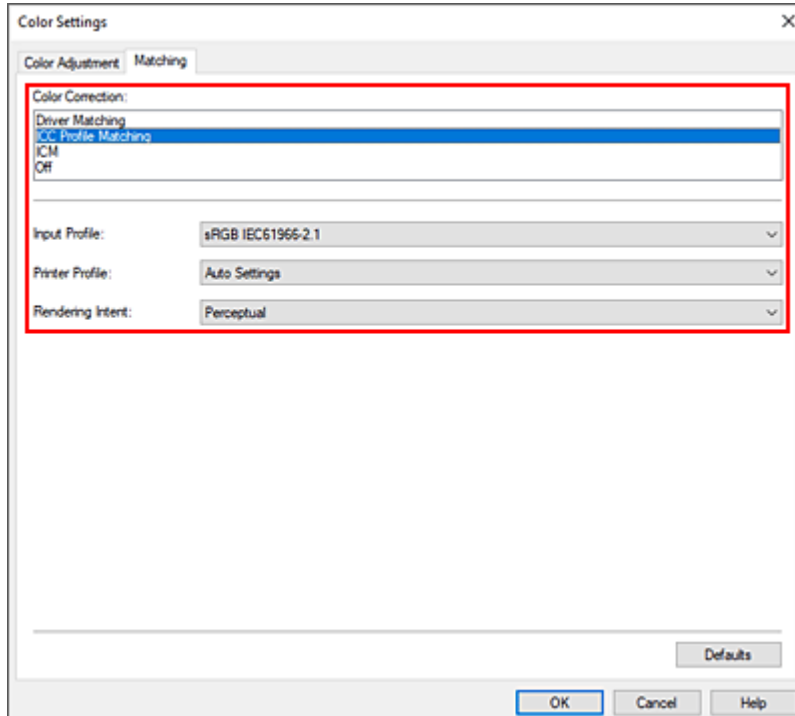

5. Select input profile

Select the **Input Profile** you want to use.

»» Important

- When the application software specifies an input profile, the input profile setting of the printer driver becomes invalid.

6. Select the printer profile

Select **Printer Profile** as follows:

- To set the printer profile automatically:
Select **Auto Settings**.
- To set the printer profile manually:
Select a printer profile that matches the media type to be used.

7. Select the rendering intent

Select the coloring adjustment method in **Rendering Intent**.

Saturation

Reproduces vivid colors on data such as a poster. In addition, prints in easy-to-see colors suitable for line drawing.

Perceptual

Reproduces colors of general photos naturally and features smooth gradation. In addition, selecting this setting allows you to adjust colors easily using an application software.

»» Important

- When you select **Perceptual** to print images, Canon recommends that you set the monitor and the environment light as follows:
 - Monitor
 - Color temperature: D50 (5000K)
 - Brightness: 100 to 120cd/m²
 - Gamma: 2.2
 - Environment light
 - Fluorescent light for D50 color evaluation (color temperature 5000K, high color rendering properties)
 - Brightness when looking at printed materials: 500 lx ± 125 lx

Relative Colorimetric

When image data is converted to the color space of the printer, this method converts the image data so the color reproduction approximates the shared color regions. Select this method to print image data with colors that are close to the original colors.

Absolute Colorimetric

When **Relative Colorimetric** is selected, white spots are reproduced as white spots of the paper (background color). However, when **Absolute Colorimetric** is selected, how the white spots are reproduced depends on the image data.

»» Important

- Depending on the media type, you may obtain the same print results even when you change the **Rendering Intent** setting.

8. Set the other items

If necessary, click **Color Adjustment** tab, and adjust the color balance (**Cyan, Magenta, Yellow**) and adjust **Brightness**, and **Contrast** settings, and then click **OK**.

9. Complete the setup

Click **OK** on the **Main** tab.

When you execute print, the printer uses the color space of the image data.

Related Topics

- ➔ [Setting the Print Quality Level \(Custom\)](#)
- ➔ [Specifying Color Correction](#)
- ➔ [Adjusting Color Balance](#)
- ➔ [Adjusting Brightness](#)
- ➔ [Adjusting Contrast](#)

Adjusting Brightness

You can brighten or darken the colors of the overall image data during printing.

The following sample shows the case when light colors are darkened when the image data is printed.



No adjustment



Darken light colors

The procedure for adjusting brightness is as follows:

1. Open the [printer driver setup window](#)
2. Select advanced settings

From the **Main** tab pull-down menu, select **Advanced Settings**.

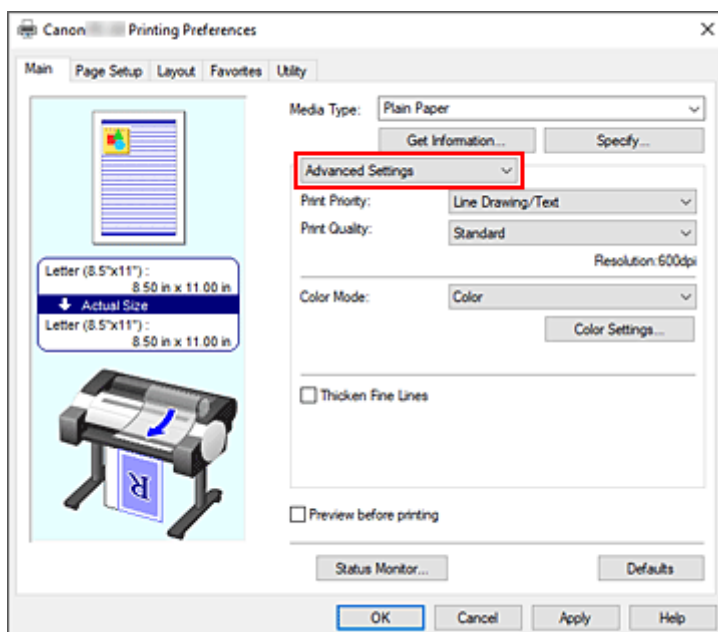

3. Select color mode

For **Color Mode**, select **Color**, and then click **Color Settings....**

The **Color Settings** dialog box appears.

4. Adjust brightness

On the **Color Adjustment** tab, moving the **Brightness** slider to the right brightens (dilutes) the colors, and moving the slider to the left darkens (intensifies) the colors.

You can also directly enter a value linked to the slider. Enter a value in the range from -50 to 50. The current settings are displayed in the settings preview on the left side of the printer driver.

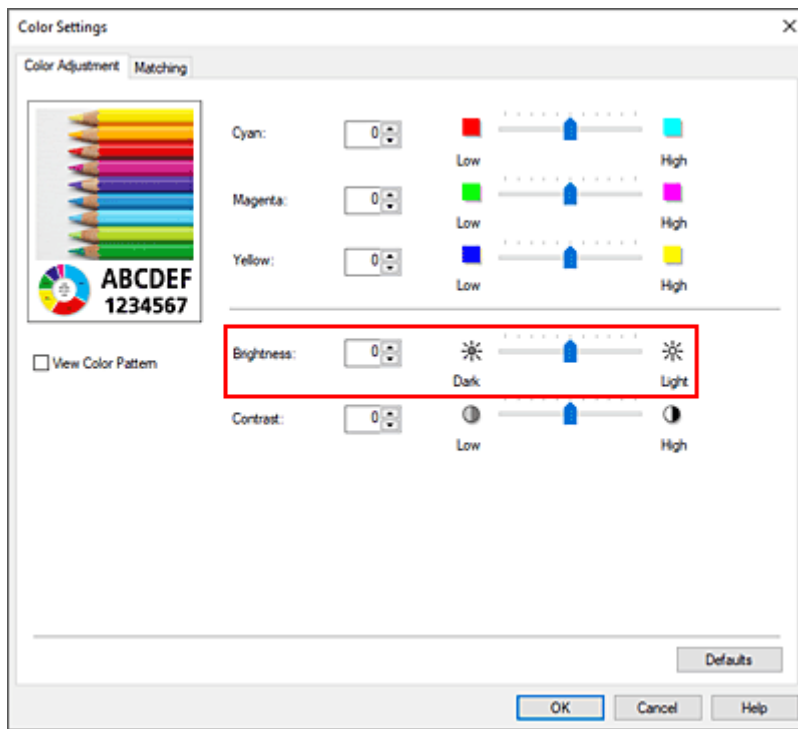

5. Complete the setup

Click **OK** on the **Main** tab.

When you execute print, the data is printed at the adjusted brightness.

Related Topics

- ➔ [Setting the Print Quality Level \(Custom\)](#)
- ➔ [Specifying Color Correction](#)
- ➔ [Adjusting Color Balance](#)
- ➔ [Adjusting Contrast](#)

Adjusting Contrast

You can adjust the image contrast during printing.

To make the differences between the light and dark portions of images greater and more distinct, increase the contrast. On the other hand, to make the differences between the light and dark portions of images smaller and less distinct, reduce the contrast.



No adjustment

Adjust the contrast

The procedure for adjusting contrast is as follows:

1. Open the [printer driver setup window](#)
2. Select advanced settings

From the **Main** tab pull-down menu, select **Advanced Settings**.

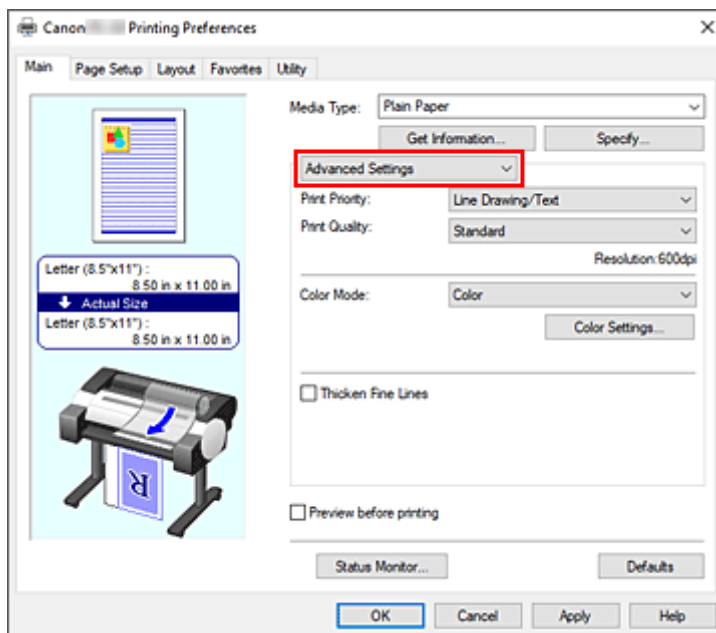

3. Select color mode

For **Color Mode**, select **Color**, and then click **Color Settings....**

The **Color Settings** dialog box appears.

4. Adjust the contrast

On the **Color Adjustment** tab, moving the **Contrast** slider to the right increases the contrast, and moving the slider to the left decreases the contrast.

You can also directly enter a value linked to the slider. Enter a value in the range from -50 to 50. The current settings are displayed in the settings preview on the left side of the printer driver.

After adjusting each color, click **OK**.

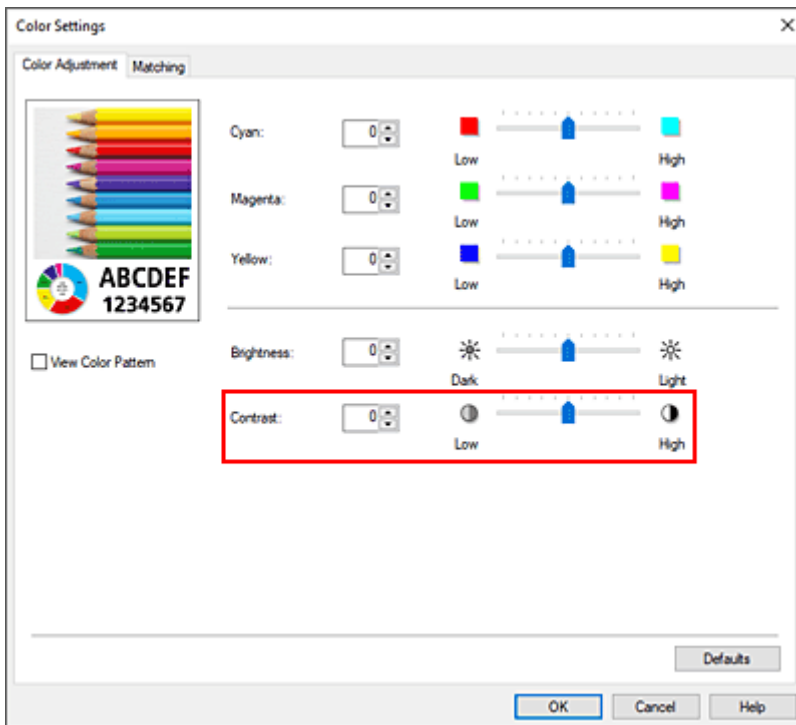

5. Complete the setup

Click **OK** on the **Main** tab.

When you execute print, the image is printed with the adjusted contrast.

Related Topics

- ➔ [Setting the Print Quality Level \(Custom\)](#)
- ➔ [Specifying Color Correction](#)
- ➔ [Adjusting Color Balance](#)
- ➔ [Adjusting Brightness](#)

Printing Using Detailed Setting Mode

You can print by using your own settings instead of the pre-registered **Print Target** settings.

The procedure for using the detailed setting mode and printing is as follows:

1. Open the [printer driver setup window](#)
2. Select the media type

Select the type of paper loaded in the printer from the **Media Type** list on the **Main** tab.

If **Auto (Use Printer Settings)** is selected, the paper configured in printer settings is printed.

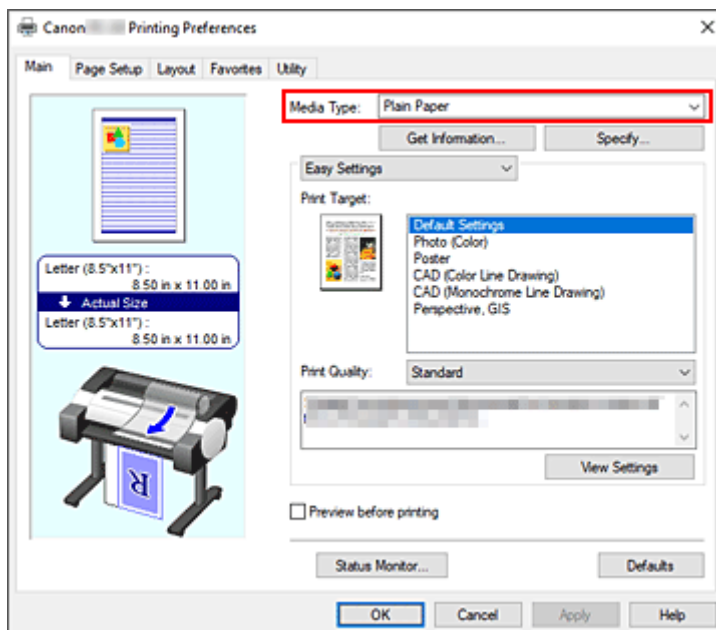

3. Select advanced settings

From the **Main** tab pull-down menu, select **Advanced Settings**.

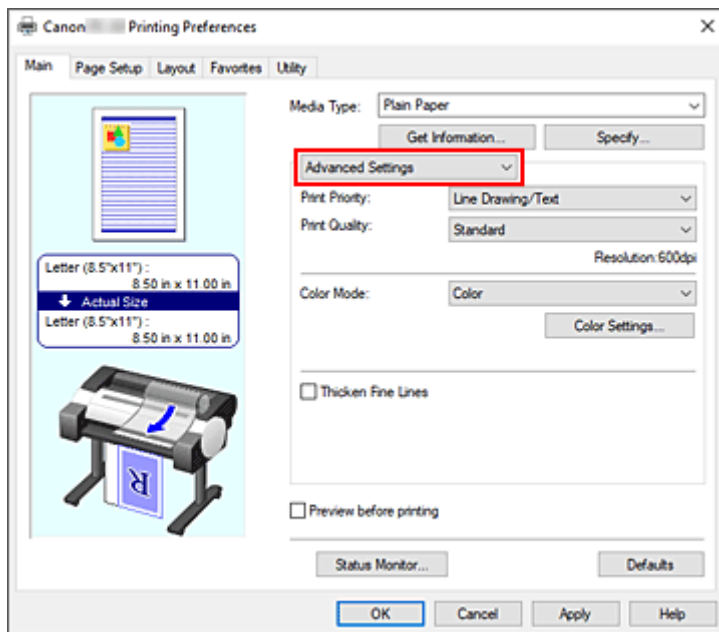

4. Set print conditions

Set the following items as necessary.

Print Priority

Select elements to prioritize for print results.

Print Quality

Selects your desired printing quality.

Select one of the following to set the print quality level that is appropriate for the purpose.

Color Mode

Selects color adjustment method.

Thicken Fine Lines

To make thin lines thicker and easier to see when printing, add a checkmark.

5. Select the paper size

From the **Page Size** list on the **Page Setup** tab, select the same size as that of the document that was created with the application software.

The current settings are displayed in the settings preview on the left side of the window.

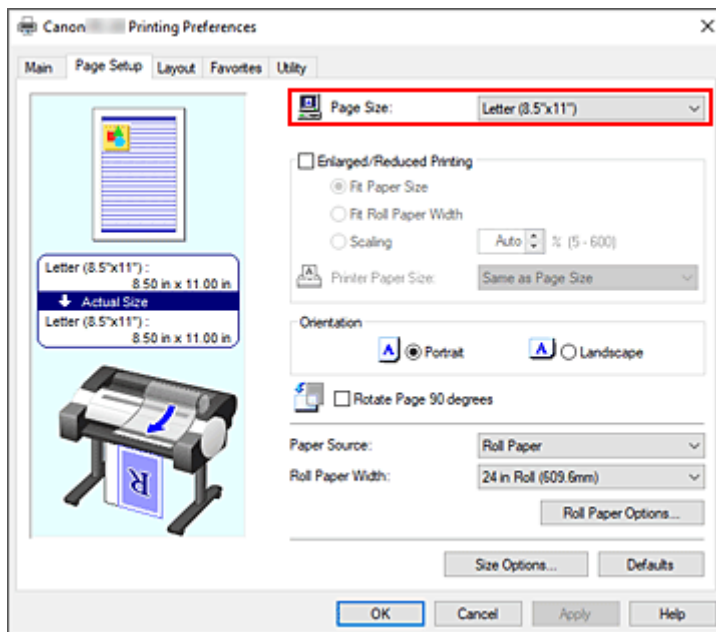

6. Select the paper source

For **Paper Source**, select the setting that matches your purpose.

7. Set the other items

Set the other items as necessary.

8. Complete the setup

Click **OK**.

When you print, the document is printed with the print conditions you set.

Related Topics

- ➔ [Adjusting Color Balance](#)
- ➔ [Setting the Print Quality Level \(Custom\)](#)
- ➔ [Specifying Color Correction](#)
- ➔ [Adjusting Brightness](#)
- ➔ [Adjusting Contrast](#)

Scaled Printing

The procedure for printing a document with pages enlarged or reduced is as follows:

1. Open the [printer driver setup window](#)

2. Select the paper size of the document

Using **Page Size** on the **Page Setup** tab, select the page size that is set with your application software.

3. Select the paper source

For **Paper Source**, select the setting that matches your purpose.

4. Select roll paper width

If you selected a roll paper for **Paper Source**, set **Roll Paper Width** to the width of the roll paper loaded in the printer.

5. Select scaled printing

Check the **Enlarged/Reduced Printing** check box.

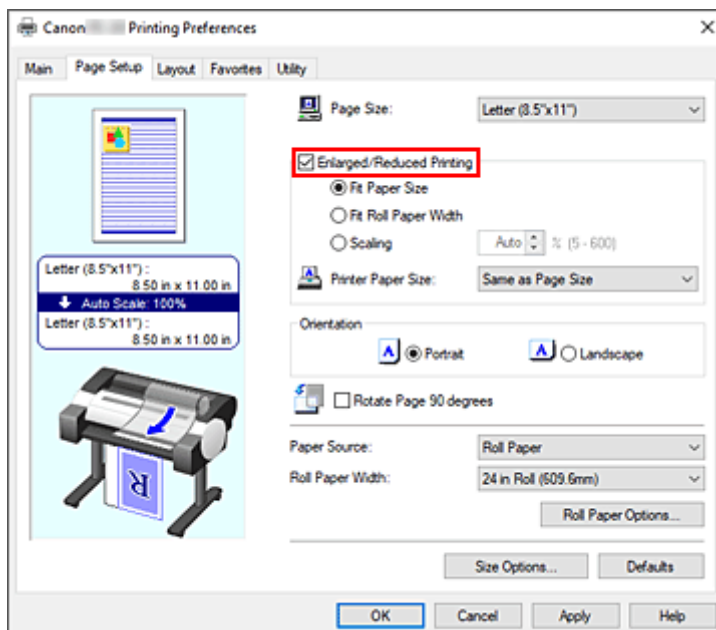

6. Set one of scaling methods described below

From the items listed below, select the setting that matches your purpose and select the corresponding check box.

The current settings are displayed in the settings preview on the left side of the window.

- **Fit Paper Size**

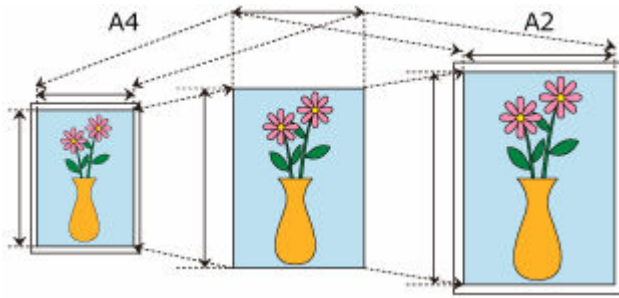

Scales the document to match the paper size.

- **Fit Roll Paper Width**

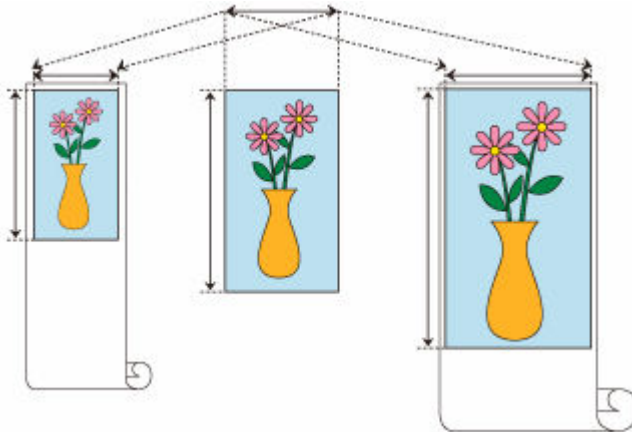

Scales the document to match the roll paper width.

- **Scaling**

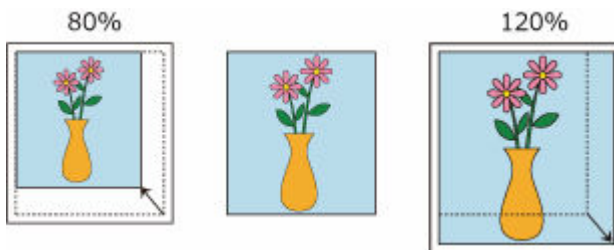

Allows you to specify the scaling by entering a number directly or by selecting the paper size you want from the **Printer Paper Size** list.

The document is reduced when a size smaller than the **Page Size** setting is selected from the **Printer Paper Size** list, and enlarged when a size larger is selected.

7. Complete the setup

Click **OK**.

When you execute print, the document will be printed with the specified scale.

»» Important

- When the application software which you used to create the original has the scaled printing function, configure the settings on your application software. You do not need to configure the same setting in the printer driver.

»» Note

- Selecting **Enlarged/Reduced Printing** changes the printable area of the document.

Printing to Oversized Paper Sizes

When printing a created document so that it fills the entire paper width, select a paper size from the **Oversize** list (sizes resulting from adding margins necessary for printer operation to the document sizes) so that all areas of the document are printed at their actual size.

A printout that has the same area as the document can be obtained by trimming the outer margins after printing.

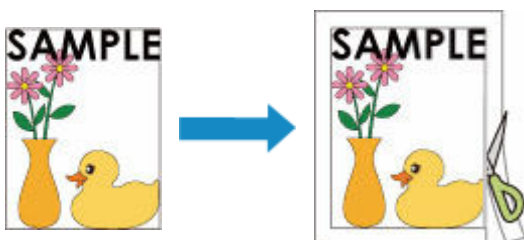

The procedure for printing with oversize is as follows:

1. Open the [printer driver setup window](#)

2. Select the paper size

From the **Page Size** list on the **Page Setup** tab, select the same size as that of the document that was created with the application software.

3. Click **Size Options...**

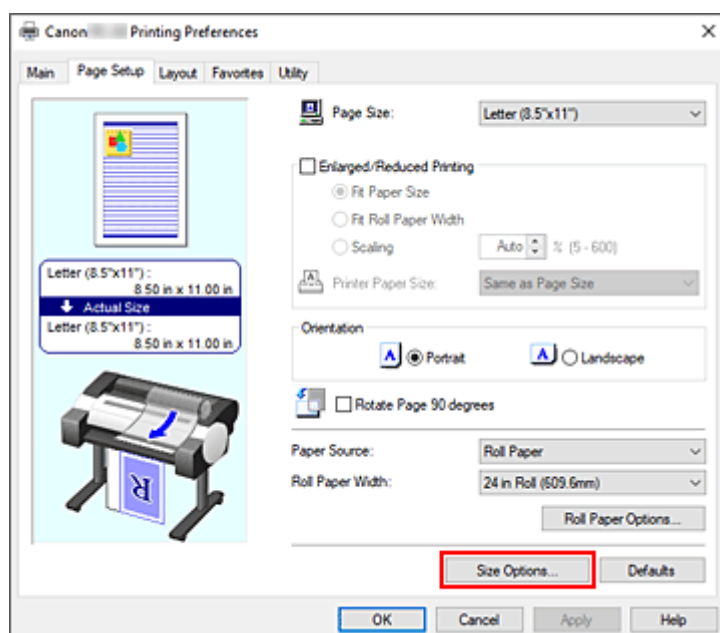

The **Paper Size Options** dialog box opens.

4. Select oversize

Select the **Oversize** check box, and click **OK**.

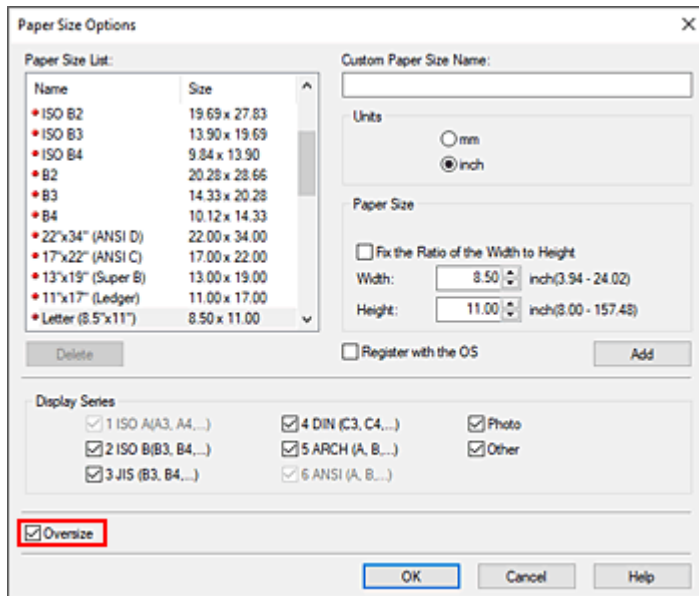

The current settings are displayed in the settings preview on the left side of the **Page Setup** tab.

5. Select the paper source

For **Paper Source**, select the setting that matches your purpose.

6. Select roll paper width

If you selected a roll paper for **Paper Source**, set **Roll Paper Width** to the width of the roll paper loaded in the printer.

7. Set the other items

Set the other items as necessary.

8. Complete the setup

Click **OK**.

When you print, the document is printed using oversize.

»»» Important

- When printing to oversized paper sizes, use paper that has the following necessary margins added to the document size.
 - Cut sheet: 6 mm or more added to width and 23 mm or more added to height of document size
 - Roll paper: 6 mm or more added to width and 6 mm or more added to height of document size

»»» Note

- An oversized paper size cannot be used for the largest paper size that can be loaded in the printer.
- To set an oversized paper size for a non-standard paper size, register the paper size in the **Paper Size Options** dialog box. An oversized paper size cannot be set for paper sizes that were set in the **Custom Size Settings** dialog box.

Setting Paper Dimensions (Custom Size)

You can specify the height and width of paper when its size cannot be selected from the **Page Size**. Such a paper size is called "custom size."

There are two ways of setting a user-defined paper, setting the paper from **Size Options...** on the **Page Setup** tab and setting the paper from **Custom Size** of **Page Size**.

If you will be using a user-defined paper repeatedly, setting it from **Size Options...** is convenient because it becomes registered to **Page Size** and can be selected any time after that.

If you want to use a user-defined paper temporarily, setting it from **Custom Size** is suitable.

The procedure for specifying a custom size is as follows:

Setting from Paper Size Options

1. Open the [printer driver setup window](#)
2. Click **Size Options...** on the **Page Setup** tab

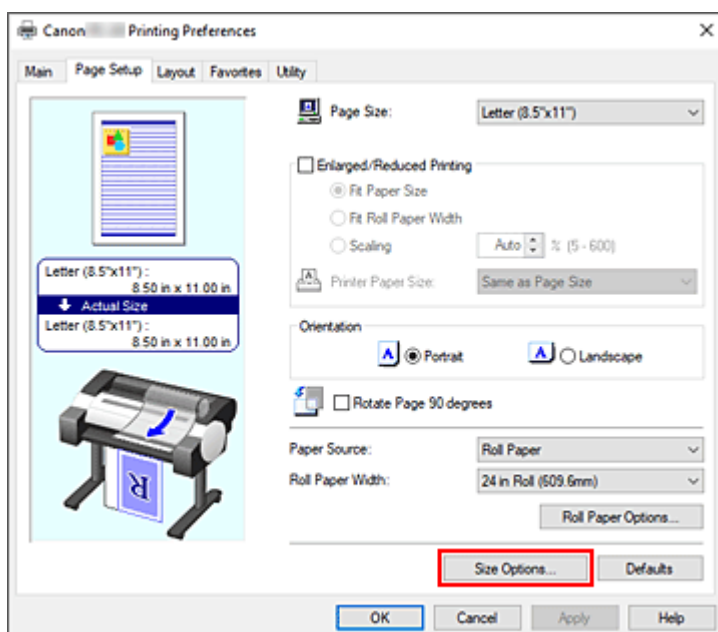

The **Paper Size Options** dialog box opens.

3. Set user-defined paper

Set **Custom Paper Size Name**, **Units**, and **Size**, and then click **Add**.

For **Size**, specify a size or select the paper size to be used from **Paper Size List**.

To narrow down the paper sizes displayed in **Paper Size List**, select the **Display Series** check box.

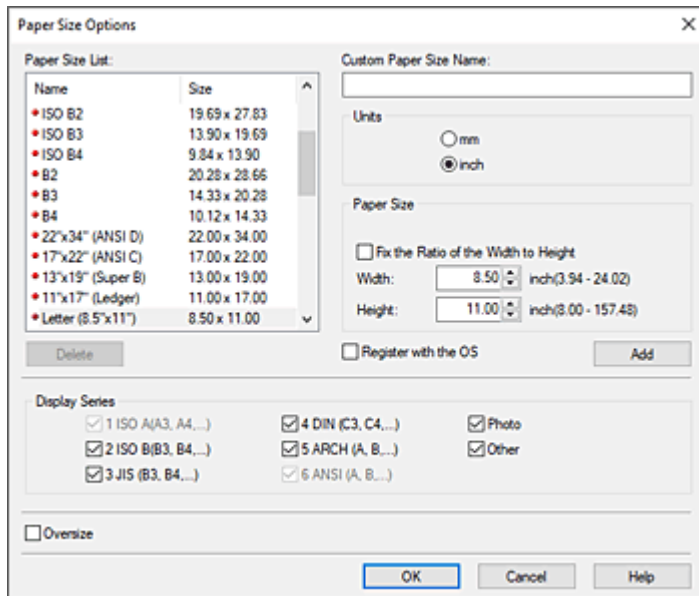

4. Set user-defined paper

Click **OK**, then it returns to **Page Setup** tab.

The paper size registered by using **Custom Paper Size Name** is registered to **Custom Paper Size of Page Size** and can be selected at any time.

Setting from Custom Size

1. Open the [printer driver setup window](#)
2. Select the paper size

For **Page Size** on the **Page Setup** tab, select **Custom Size** from the **Custom Paper Size** list.

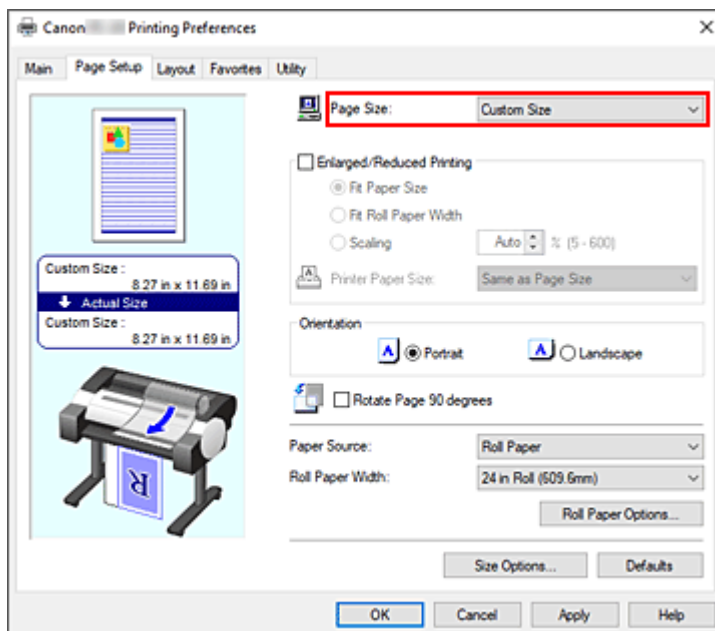

The **Custom Size Settings** dialog box opens.

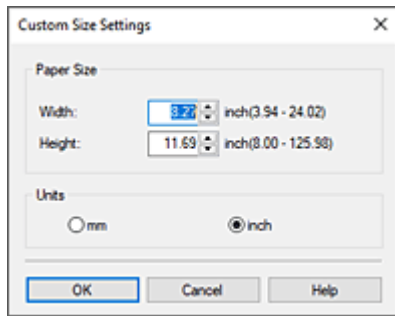

3. Set the custom paper size

Enter the **Width** and **Height** values of the paper to be used, specify the **Units**, and then click **OK**.

4. Complete the setup

Click **OK** on the **Page Setup** tab.

When you execute print, the data is printed with the specified paper size.

»» Important

- If the application software that created the document has a function for specifying height and width values, use the application software to set the values. If the application software does not have such a function or if the document does not print correctly, perform the above procedure from the printer driver to set the values.
- Printing may be disabled depending on the size of the specified user-defined media. For information about printable sizes for user-defined media, see "[Paper Sizes](#)."
- Any paper size that was set by using **Custom Size** can no longer be used after the application software is closed.

»» Note

- If the paper settings in the printer driver differ from the paper information registered on the printer, an error message may appear on the printer's operation panel. You can still print but you may not be able to obtain correct print results.
- The maximum configurable size with **Custom Size** is 3.2m.

Printing Hanging and Horizontal Banners (Large-Format Printing)

A drapery or banner can be made by enlarging or reducing original documents made on application software.

The procedure for printing hanging and horizontal banners is as follows:

Print for width of roll

1. Create document by using application software
2. Open the [printer driver setup window](#)
3. Select the paper size

Select the same original paper size created in the application soft in the **Page Size** on the **Page Setup** tab.

In the event an optional size is set in the application software, select **Custom Size** from **Custom Paper Size** in **Page Size** and [designate size](#) in the dialog box that appears.

4. Select roll width

Select the equivalent to the paper width of the roll set in the printer under **Roll Paper Width**.

5. Set **Enlarged/Reduced Printing**

Check **Enlarged/Reduced Printing** and select **Fit Roll Paper Width**.

When the **Information** dialog box appears, select the equivalent to the paper width of the roll set in the printer.

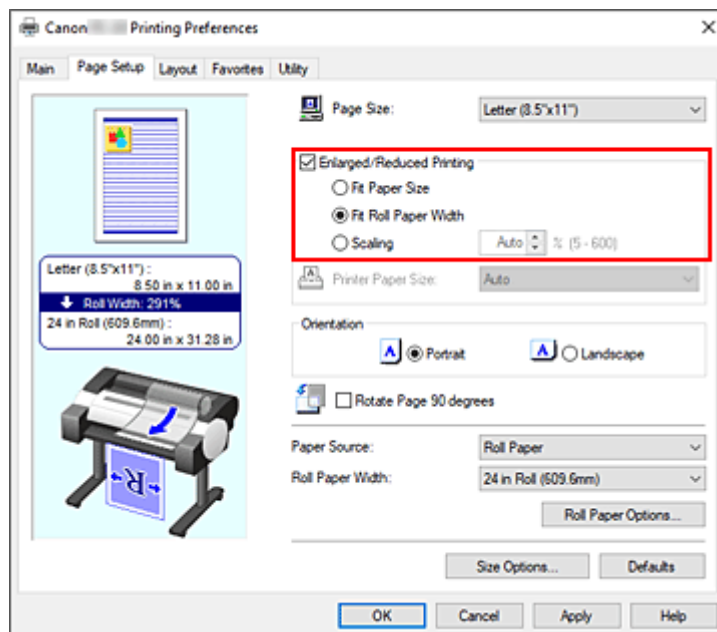

6. Complete the setup

Click **OK**.

When printing is executed, a drapery or banner can be printed according to the roll.

Enlarge and print

1. Register user-defined paper

Register both the actual desired print size (user-defined paper 1) and original document size created in application (user-defined document size 2) in the [Size Options...](#) under the **Page Setup** tab.

▶▶▶ Note

- Please set user-defined paper 2 to the same aspect ratio as user-defined paper 1. If the aspect ratio differs, the enlarged image may not turn out to be the expected size.
After creating user-defined paper 1, if user-defined paper 2 is created after checking **Fix the Ratio of the Width to Height**, settings can be set to the same aspect ratio.
Also set user-defined paper 2 to a size that doesn't exceed the maximum size supported by the application.
For example, when printing on paper 600mm wide and 3,000mm long, use the following settings.
(when setting length to 1/6 the user-defined paper)
 - User-defined paper 1: **Width** 600mm, **Height** 3,000mm
 - User-defined paper 2: **Width** 100mm, **Height** 500mm

2. Create original document in application software

Use the registered user-defined paper 2 size to create original document using an application.

3. Open printer driver settings screen

4. Select Paper Size

Select registered user-defined paper 1 from **Custom Paper Size** in the **Page Size** on the **Page Setup** tab.

5. Complete the setup

Click **OK**.

When you print, the hanging or horizontal banner is printed by using the user-defined size.

▶▶▶ Note

- Maximum printable length is 4.0m. In the event the enlarged length exceeds 4.0m, the part of the image exceeding the length will not be printed.
- If printing cannot be performed correctly, you may be able to improve printing by using the **Special Settings** dialog box on the **Layout** tab to change **FineZoom Settings** to **Yes**.

Printing by Dividing/Joining Documents

- **Inputting Documents Created Using Multiple Applications into Free Layout plus**
- **Printing by Connecting Multiple Pages**
- **Printing Multiple Pages All on One Page**
- **Dividing and Printing Posters**

Printing by Connecting Multiple Pages

Print documents with several pages as one continuous document. When you do this, the spaces between the pages will be removed.

The procedure for printing by connecting multiple pages is as follows:

1. Open the [printer driver setup window](#)

2. Select the paper source

For **Paper Source** on the **Page Setup** tab, select **Roll Paper**.

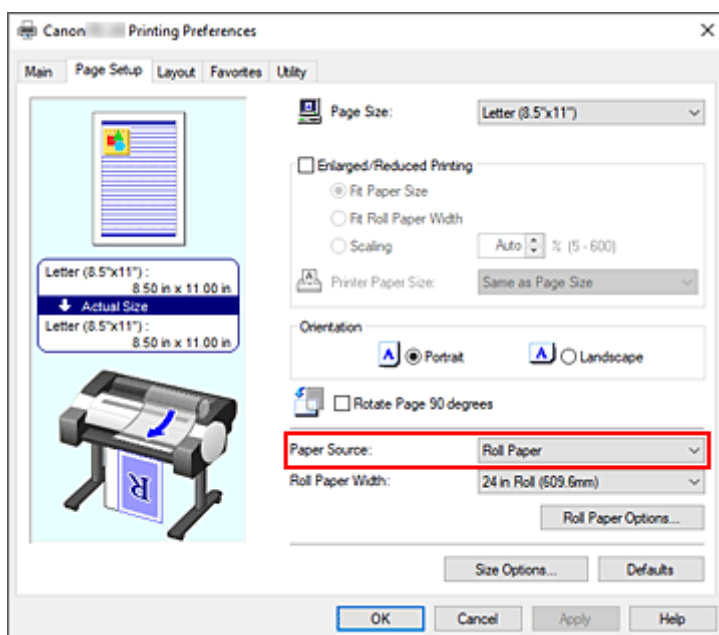

3. Set roll paper options

Click **Roll Paper Options...** to display the **Roll Paper Options** dialog box.

Select the **Banner Printing** check box, and then click **OK**.

The current settings are displayed in the settings preview on the left side of the **Page Setup** tab.

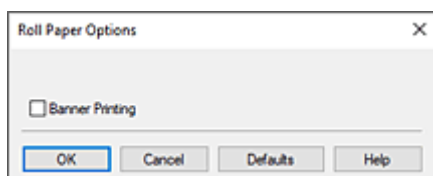

4. Complete the setup

Click **OK** on the **Page Setup** tab.

When you print, the document is printed with the print conditions you set.

Printing Multiple Pages All on One Page

The page layout printing function allows you to print more than one page image on a single sheet of paper.



The procedure for printing multiple pages all on one page is as follows:

1. Open the [printer driver setup window](#)
2. Select the print paper size

From the **Page Size** list on the **Page Setup** tab, select the size of the paper loaded in the printer.

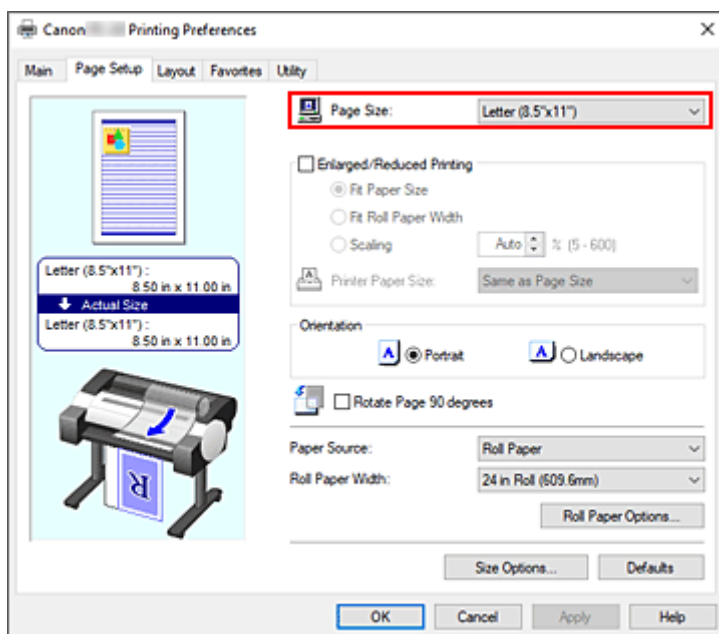

3. Set number of pages to be printed per sheet

On the **Layout** tab, select the **Page Layout** check box, and from the pull-down menu, select **2 Pages/Sheet**, **4 Pages/Sheet**, **6 Pages/Sheet**, **8 Pages/Sheet**, **9 Pages/Sheet**, or **16 Pages/Sheet**.

The current settings are displayed in the settings preview on the left side of the window.

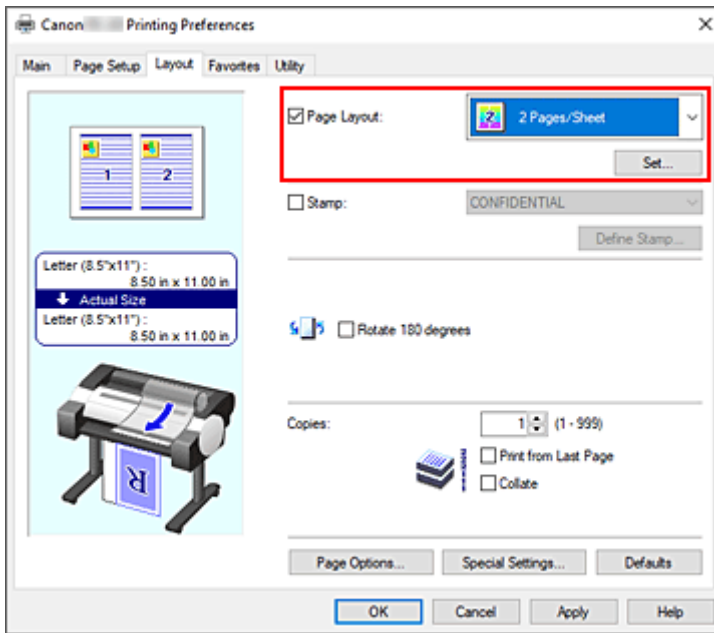

4. Set the number of pages to be printed on one sheet and the page order

If necessary, click **Set...**, specify the following settings in the **Page Layout Printing** dialog box, and click **OK**.

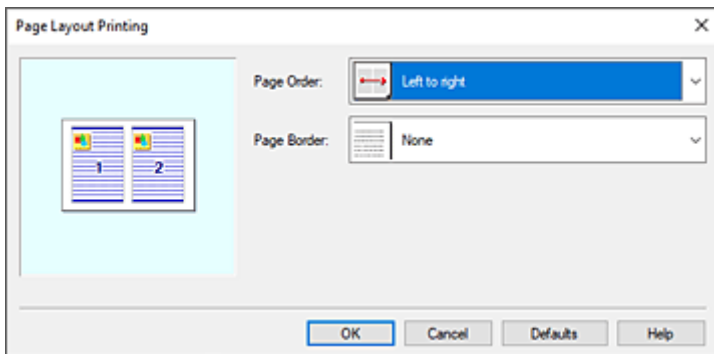

Page Order

To change the page arrangement order, select a placement method from the list.

Page Border

To print a page border around each document page, select something other than **None** from the list.

5. Complete the setup

Click **OK** on the **Layout** tab.

When you execute print, the specified number of pages will be arranged on each sheet of paper in the specified order.

»»» Important

- When there is a checkmark next to **Banner Printing** under **Roll Paper Options** dialog box on the **Page Setup** tab, **Page Layout** is grayed out and cannot be set.
- If **Spooling at Printer Driver** in **Special Settings** dialog box is set to **No (Use RAW Spooling)**, **Page Layout** is grayed out and cannot be set.

Dividing and Printing Posters

The tiling/poster printing function allows you to enlarge image data, divide it into several pages, and print these pages on separate sheets of paper. You can also paste the pages together to create a large print like a poster.

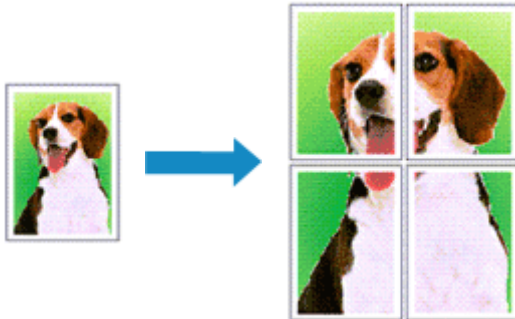

The procedure for dividing and printing posters is as follows:

Setting for Dividing and Printing Posters

1. Open the [printer driver setup window](#)
2. Select the print paper size

From the **Page Size** list on the **Page Setup** tab, select the size of the paper loaded in the printer.

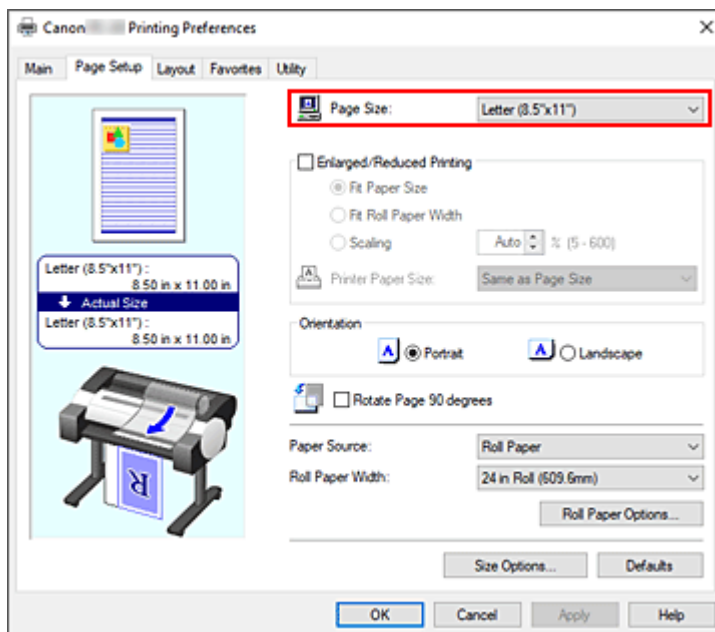

3. Set number of divisions

On the **Layout** tab, select the **Page Layout** check box, and from the pull-down menu, select **Poster (1 x 2)** or **Poster (2 x 2)**.

The current settings are displayed in the settings preview on the left side of the window.

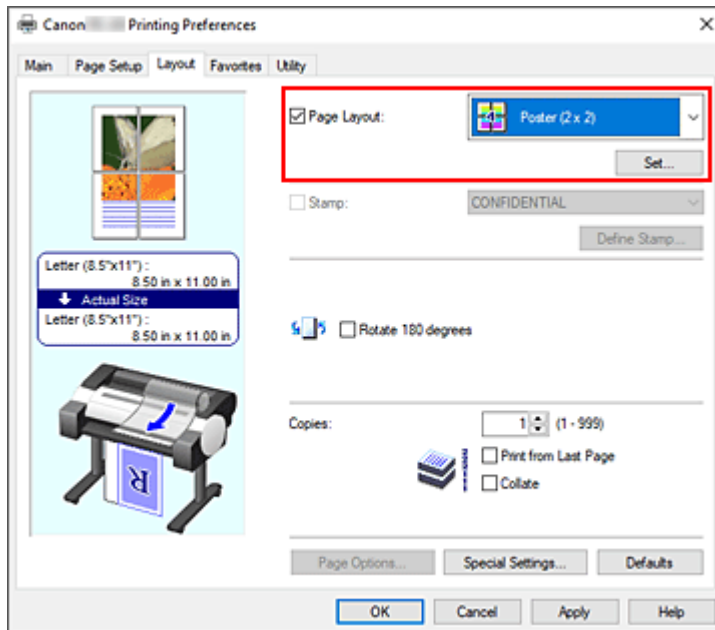

4. Complete the setup

Click **OK** on the **Layout** tab.

When you execute print, the document will be divided into several pages during printing.

►► Important

- When there is a checkmark next to **Banner Printing** under **Roll Paper Options** dialog box on the **Page Setup** tab, **Page Layout** is grayed out and cannot be set.
- If **Spooling at Printer Driver** in **Special Settings** dialog box is set to **No (Use RAW Spooling)**, **Page Layout** is grayed out and cannot be set.

Printing Only Specific Pages

If ink becomes faint or runs out during printing, you can reprint only the specific pages by following the procedure below:

1. Display **Pages to Print** dialog box

For **Page Layout**, click **Set...** to display the **Pages to Print** dialog box.

2. Set print range

Clear the check boxes of the pages you do not want to print.

In the setting view, the pages that you cleared are deleted and only the pages to be printed are displayed.

Check the pages to be printed, and then click **OK**.

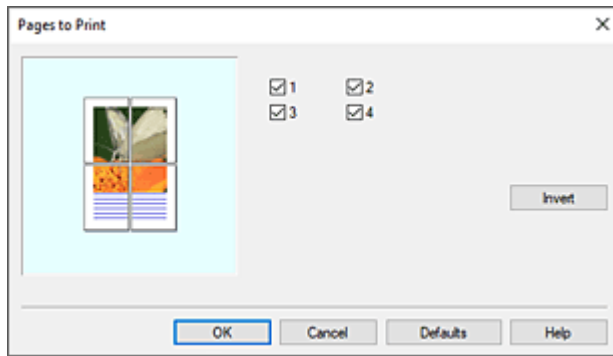

▶▶▶ Note

- In the setting view on the left side of the **Pages to Print** dialog box, you can also clear the display by clicking the pages you do not want to print. To redisplay a cleared page, click that page again.
- To switch the pages to display/hide, click **Invert** in the **Pages to Print** dialog box.

3. Complete the setup

Click **OK** on the **Layout** tab.

When you print, only the specified pages are printed.

▶▶▶ Important

- If you partition and print as a poster, the source document will be printed in enlarged form, so the print results may become rough.

Printing by Saving Roll Paper

- ▶ [Saving Roll Paper by Rotating Document 90 Degrees](#)

Saving Roll Paper by Rotating Document 90 Degrees

When printing a portrait document on roll paper, you can save paper by rotating the document 90 degrees and printing the document so that it is oriented horizontally relative to the paper.

The procedure for saving paper by rotating the document 90 degrees is as follows:

1. Open the [printer driver setup window](#)

2. Select the media type

Select the type of paper loaded in the printer from the **Media Type** list on the **Main** tab.

If **Auto (Use Printer Settings)** is selected, the paper configured in printer settings is printed.

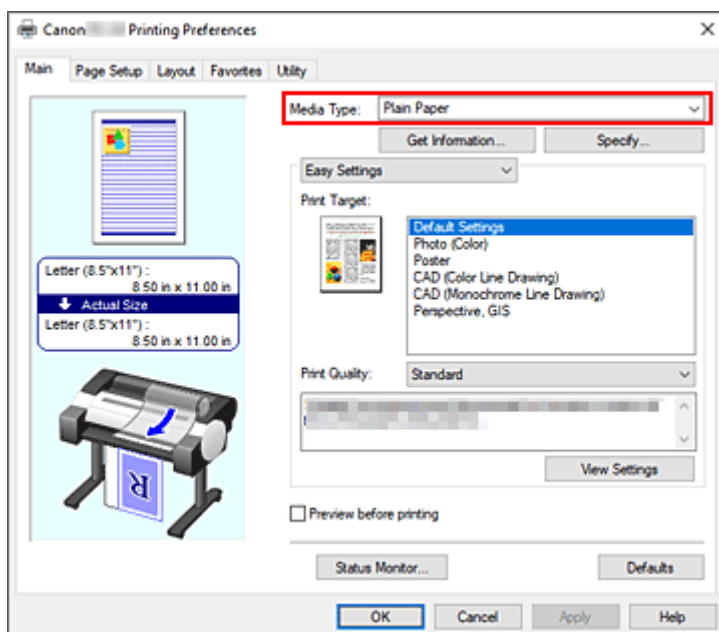

3. Select the paper size

From the **Page Size** list on the **Page Setup** tab, select the same size as that of the document that was created with the application software.

4. Select the paper source

In **Paper Source**, select **Roll Paper**.

5. Selecting Paper Saving

Select the **Rotate Page 90 degrees** check box.

The current settings are displayed in the settings preview on the left side of the window.

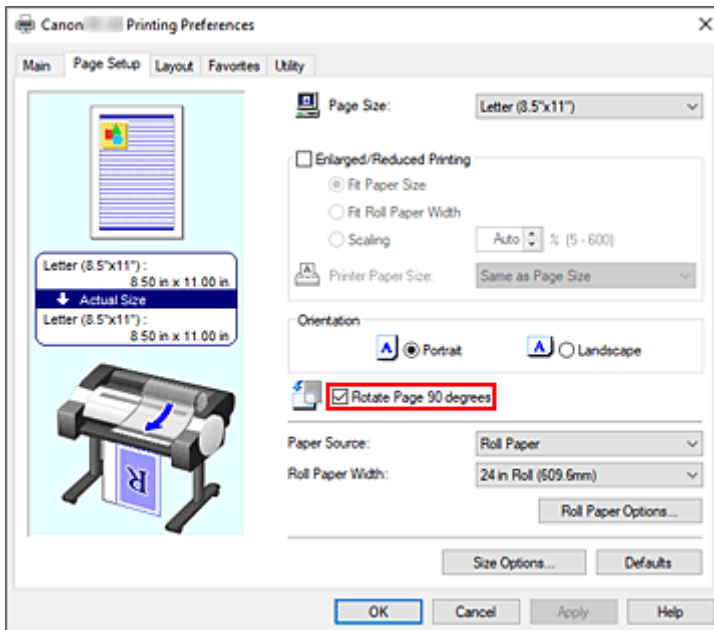

6. Select roll paper width

For **Roll Paper Width**, select the width of the roll paper loaded in the printer.

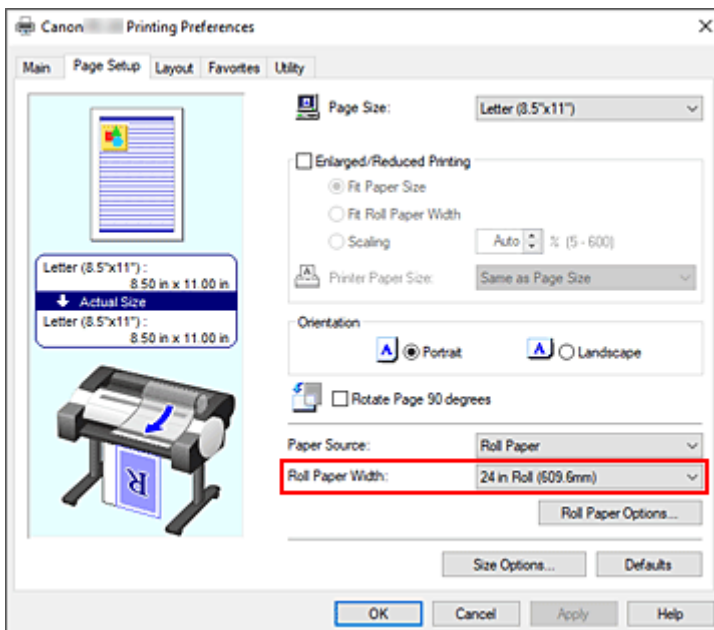

7. Complete the setup

Click **OK**.

When you print, you can rotate a portrait document 90 degrees to save paper.

»» Important

- When there is a checkmark next to **Banner Printing** under **Roll Paper Options** dialog box on the **Page Setup** tab, **Rotate Page 90 degrees** is grayed out and cannot be set.

- When selecting paper in portrait format as the **Page Size** from the **Page Setup** tab, if the length in the vertical direction is longer than the width selected in **Roll Paper Width**, even if a checkmark is placed next to **Rotate Page 90 degrees**, the page will not be rotated.

Switching the Paper Source to Match the Purpose

This printer has two paper sources: Roll and Top Feed.

You can facilitate printing by selecting a paper source setting that matches your media type or purpose.

The procedure for setting paper source is as follows:

1. Open the [printer driver setup window](#)

2. Select the media type

Select the type of paper loaded in the printer from the **Media Type** list on the **Main** tab.

If **Auto (Use Printer Settings)** is selected, the paper configured in printer settings is printed.

3. Select the paper source

From the **Paper Source** list on the **Page Setup** tab, select the paper source that matches your purpose.

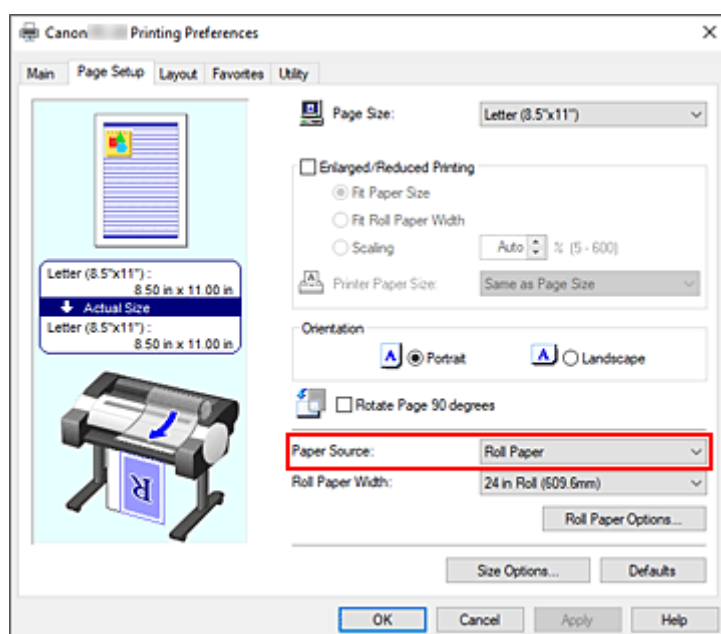

Roll Paper

Feeds paper using roll paper.

Top Feed

Feeds paper using the cut sheet.

4. Complete the setup

Click **OK**.

When you execute print, the printer uses the specified paper source to print the data.

»» Note

- If the paper settings in the printer driver differ from the paper information registered on the printer, an error message may appear on the printer's operation panel. You can still print but you may not be able to obtain correct print results.

Displaying the Print Results before Printing

You can display and check the print result before printing.

The procedure for displaying the print result before printing is as follows:

1. Open the [printer driver setup window](#)
2. Set the preview

Check the **Preview before printing** check box on the **Main** tab.

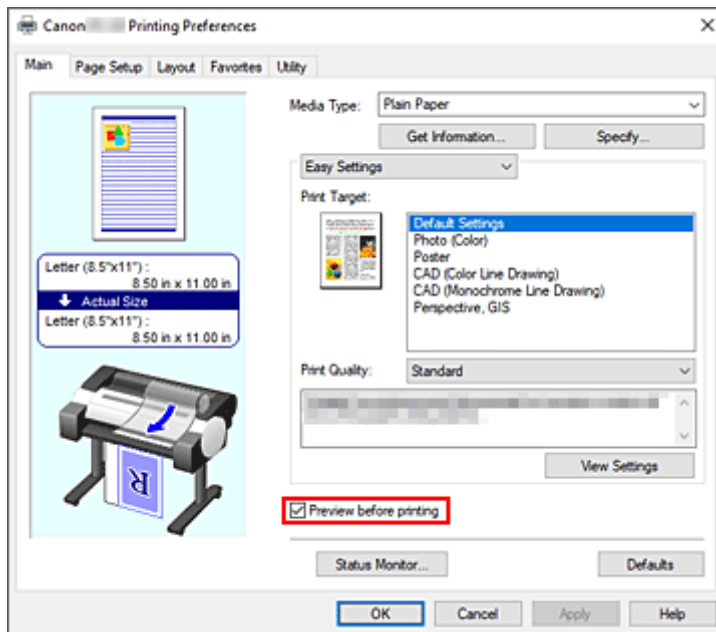

3. Complete the setup

Click **OK**.

When you execute print, the Canon imagePROGRAF Preview opens and displays the print results.

Related Topic

➔ [Canon imagePROGRAF Preview](#)

Other Convenient Settings

- **Stamp Printing**
- **Setting a Page Size and Orientation**
- **Registering a Frequently Used Printing Profile**

Stamp Printing

The **Stamp** function allows you to print a stamp text over or behind document data.

"DRAFT," "CONFIDENTIAL," and other stamps that are used often in companies are pre-registered.

The procedure for printing with a stamp is as follows:

1. Open the [printer driver setup window](#)
2. Select stamp

On the **Layout** tab, select the **Stamp** check box, and then select the stamp to use from the list.

The current settings are displayed in the settings preview on the left side of the **Layout** tab.

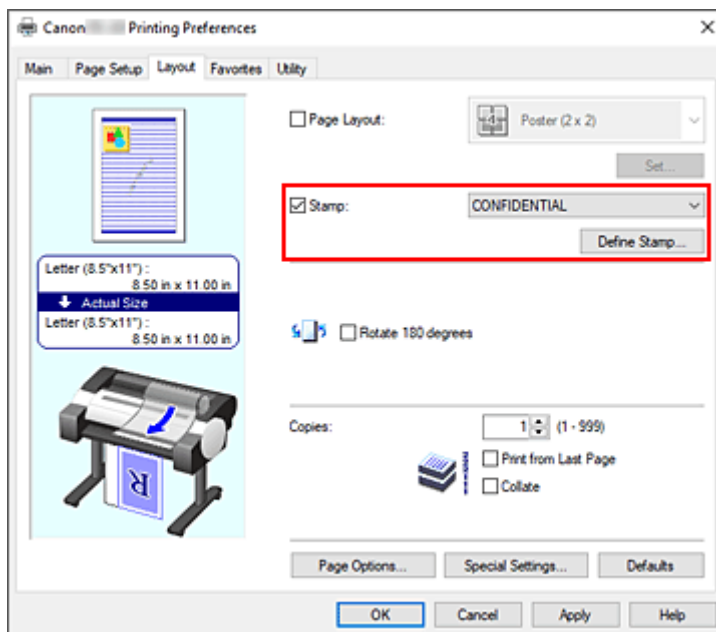

3. Complete the setup

Click **OK**.

When you execute print, the data is printed with the specified stamp.

»»» Important

- Depending on your usage environment, you may not be able to use the **Stamp** function. In this case, set **Spooling at Printer Driver** in the [Special Settings dialog box](#) to **Yes**.

Registering a Stamp

You can create and register a new stamp. You can also change and re-register some of the settings of an existing stamp. Unnecessary stamps can be deleted at any time.

The procedure for registering a new stamp is as follows:

Registering a New Stamp

1. Open the [printer driver setup window](#)
2. Select stamp

On the **Layout** tab, select the **Stamp** check box, and click **Define Stamp....**

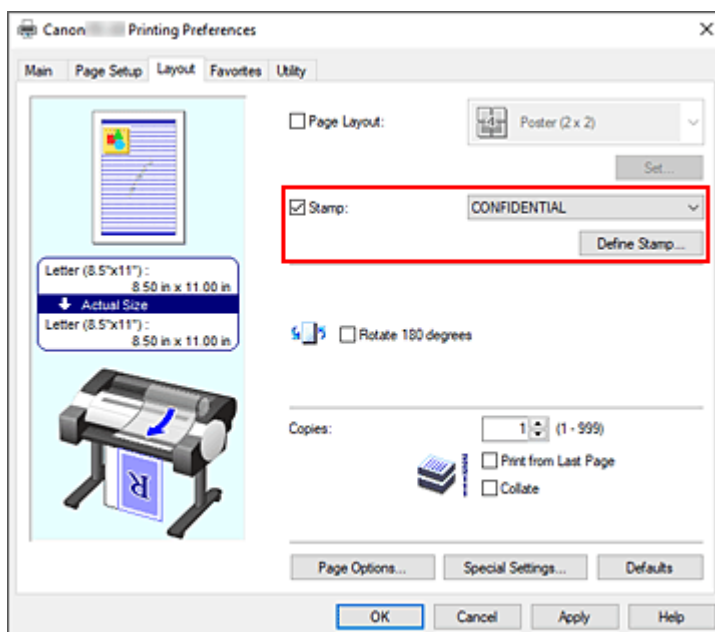

The **Define Stamp** dialog box opens.

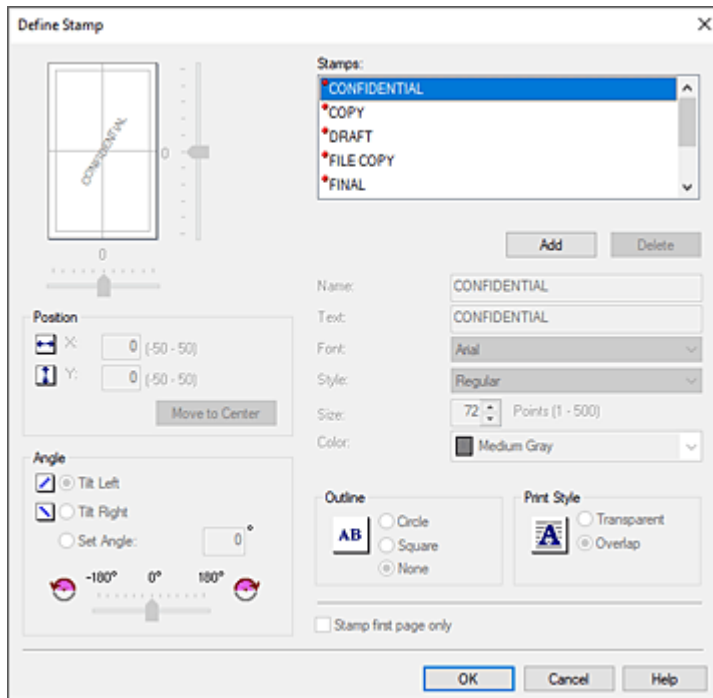

3. Set stamp details

Click **Add** to add a new stamp (**Untitled**) to the list.

In **Name**, enter the name of the stamp to register, and in **Text**, enter the character string you want as the stamp.

Change the **Font**, **Style**, **Size**, and **Color** settings as necessary.

4. Set the other items

Set the following items as necessary.

Outline

Selects a frame that encloses the stamp text string.

Print Style

Select the stamp print method.

Select **Transparent** to print the stamp on the back of the document, and select **Overlap** to print it on the front.

Position

Specifies the stamp position on the page.

Enter numbers in **X** and **Y** to set the coordinates, or drag the horizontal and vertical slide bars to the left/right or up/down to change the settings.

Angle

Set the stamp placement angle.

Enter a number in **Set Angle** to set the angle, or drag the slide bar to the left/right to change the setting.

Set the angle by entering a number in range of -180 to 180.

Stamp first page only

To print the stamp on the first page only, select this check box.

5. Complete the setup

Click **OK** to return to the **Layout** tab.

The registered title appears in the **Stamp** list.

Changing and Registering Some of Stamp Settings

1. Select stamp

On the **Layout** tab, select the **Stamp** check box, and click **Define Stamp...**

The **Define Stamp** dialog box opens.

2. Select the stamp for which the settings are to be changed

From **Stamps**, select the title of the stamp you want to change the settings for.

3. Configure each setting while viewing the preview

4. Complete the setup

Click **OK** to return to the **Layout** tab.

The registered title appears in the **Stamp** list.

▶▶▶ Note

- The stamp registered as the default setting cannot be changed.

Deleting an Unnecessary Stamp

1. Select stamp

On the **Layout** tab, select the **Stamp** check box, and click **Define Stamp...**

The **Define Stamp** dialog box opens.

2. Select the stamp to be deleted

Select the title that you wish to delete from the **Stamps** and click **Delete**.

Click **Yes** when the confirmation message appears.

3. Complete the setup

Click **OK** to return to the **Layout** tab.

▶▶▶ Note

- The stamp registered as the default setting cannot be deleted.

Setting a Page Size and Orientation

The paper size and orientation are essentially determined by the application software. When the page size and orientation set for **Page Size** and **Orientation** on the **Page Setup** tab are same as those set with the application software, you do not need to select them on the **Page Setup** tab.

When you are not able to specify them with the application software, the procedure for selecting a page size and orientation is as follows:

1. Open the [printer driver setup window](#)
2. Select the paper size

Select a page size from the **Page Size** list on the **Page Setup** tab.

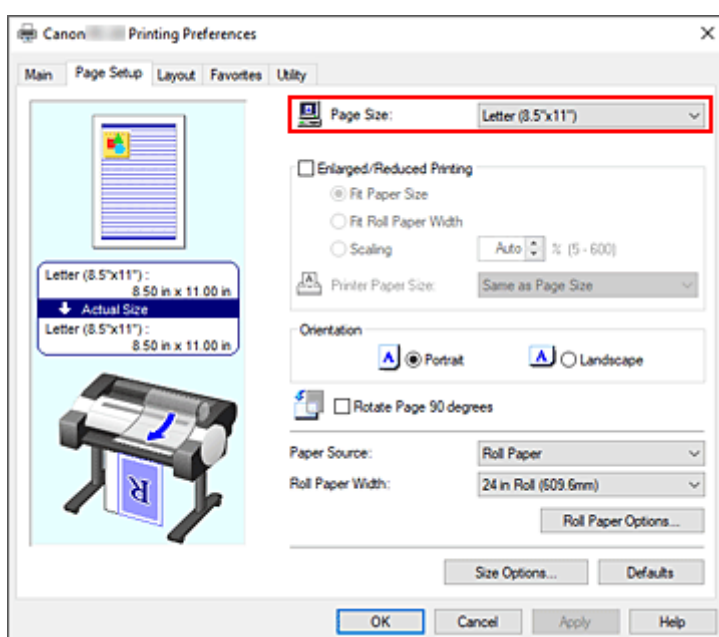

3. Set Orientation

Select **Portrait** or **Landscape** for **Orientation**. Check **Rotate Page 90 degrees** check box when you want to perform printing with the original being rotated 90 degrees.

4. Complete the setup

Click **OK**.

When you execute print, the document will be printed with the selected page size and the orientation.

Registering a Frequently Used Printing Profile

You can register the frequently used printing settings to **Favorites**. Unnecessary printing profiles can be deleted at any time.

The procedure for registering a printing profile is as follows:

Registering a Printing Profile

1. Open the [printer driver setup window](#)

2. Set the necessary items

On the **Main** tab, the **Page Setup** tab, and the **Layout** tab, specify the print settings you want to register.

3. Display **Add** dialog box

On the **Favorites** tab, click **Add...**

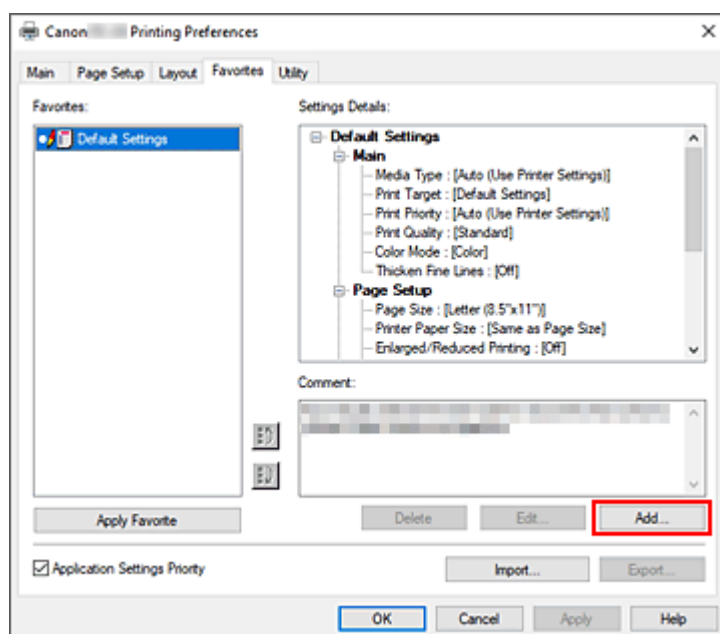

The **Add** dialog box opens.

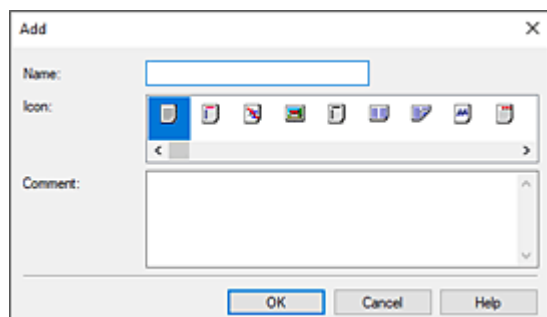

4. Register favorite setting

In **Name**, enter the name of the favorite. Set the **Icon** and **Comment** fields as necessary, and then click **OK**.

The name and the icon appear in the **Favorites** list.

To check the settings of the registered favorite, click **Settings Details**.

»» Note

- To save the settings of the favorite to a file, click **Export...** on the **Favorites** tab.

Printing Using Favorite Settings

1. Open the printer driver setup window

2. Apply favorite

From the **Favorites** list on the **Favorites** tab, select the favorite you want to use.

Click **Apply Favorite** to replace the registered print settings.

3. Complete the setup

Click **OK**.

When you print, the document is printed with the settings of the registered favorite.

Deleting Unnecessary Printing Profile

1. Select favorite to be deleted

Select the favorite you want to delete from the **Favorites** list on the **Favorites** tab.

2. Delete setting

Click **Delete**. When the confirmation message appears, click **OK**.

The selected favorite is deleted from the **Favorites** list.

»» Note

- Printing profiles that are registered in the initial settings cannot be deleted.
- The settings of the favorite being applied to the current print settings cannot be deleted. To delete that favorite, select another favorite from the **Favorites** list, click **Apply Favorite** to apply the settings of that other favorite, and then delete the target favorite.

Printing from Printer

This function is available only for TC-20M.

- **Printing Photographs Saved on USB Flash Drive**
- **Printing Documents (PDF) Saved on USB Flash Drive**

Printing Photographs Saved on USB Flash Drive

You can print the photograph saved on the USB flash drive easily.

▶▶▶ Note

- Can print JPEG data taken with cameras conforming to Design Rule for Camera File System specifications. Images must conform to Exif 2.2/2.21/2.3. Other types of images or movies such as RAW images cannot be printed.
- Can print images scanned and saved by the printer itself with **Doc.type** set to **Photo** and **Format** set to **JPEG** (file extension ".jpg").

1. Load paper.

- ➔ [Loading Rolls in the Printer](#)
- ➔ [Loading Sheets in the Printer](#)

3. Insert USB flash drive into USB flash drive port.

4. Select **Others** on the HOME screen.

- ➔ [Home Screen Menu Composition](#)

5. Select **Print from**.

6. Select **Print from USB flash drive**.



The photo selection screen is displayed.

▶▶▶ Note

- If both photo files and PDF files are saved on the USB flash drive, the confirmation screen to select which file you print is displayed. Select **Print photos** in the displayed screen.
- If no printable photo data is saved on the USB flash drive, **Saved data is not of a supported type.** is displayed on the touch screen.
- If more than 2,000 photo data are saved on the USB flash drive, the photo data is split by group per 2,000 photos in reverse chronological order (date last modified) automatically. Check the message displayed on the touch screen and select **OK**.

7. Specify settings as necessary.

- To select the photo to print:
Flick horizontally to select the photo.

You can also scroll through the photos with  and .



- To change the display method, the number of copies, or the print settings:
Select  near the bottom of the displayed photo to display menus.

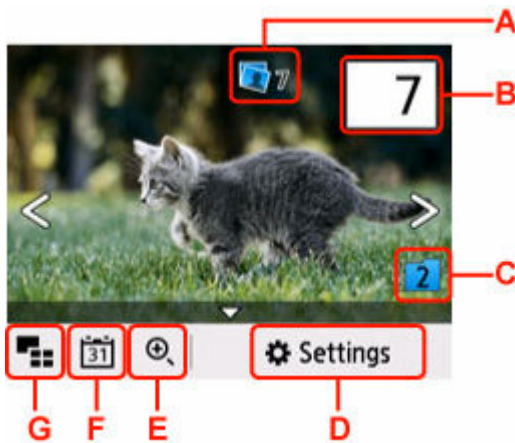



A: Total number of copies is displayed

When selecting, the Check total no. of copies screen is displayed and you can check the number of copies for each photo. On the Check total no. of copies screen, you can change the number of copies for each photo.

B: Specify the number of copies



Use  and  to specify the number of copies.

Touch and hold to specify the number of copies by 10 copies.

You can also flick the number to specify.

▶▶▶ Note

- You can specify the number of copies for each photo. Display the photo you want to print and specify the number of copies when the desired photo is displayed.

C: Select to switch the photo group.

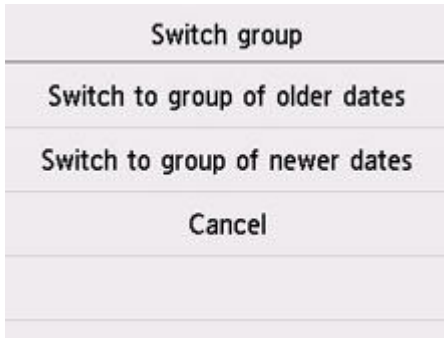

For details:



➡ [Using Useful Display Functions](#)

D: Select to display the **Settings** screen.

You can change the settings of page size, media type, and print quality and so on.



▶▶▶ Note

- Some settings cannot be specified in combination with the setting of other setting item. If the setting which cannot be specified in combination is selected,  appears on the touch screen. In this case, select  on the upper left on the touch screen to check the message and change the setting.

E: Select to zoom in on the photo.



For details:

➡ [Using Useful Display Functions](#)

F: Select to display photo with specifying the date (last modified date of data).

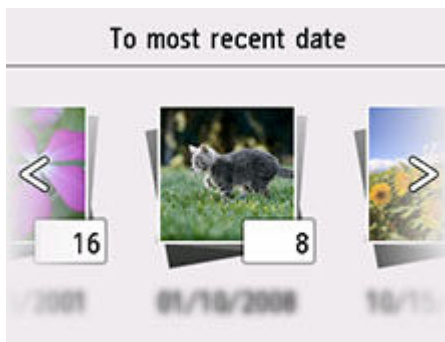

For details:

➔ [Using Useful Display Functions](#)

G: Select to display the multiple photos at once.



For more on the display method:

➔ [Using Useful Display Functions](#)

8. Press **Color** button.

The printer starts printing.

▶▶▶ Note

- To cancel printing, press the **Stop** button.
- While processing the print job, you can add the print job (Reserve photo print).
➔ [Adding Print Job](#)

Adding Print Job

You can add the print job (Reserve photo print) while printing photos.

Follow the procedure below to add the print job.

1. Flick photo while printing to select next photo.

▶▶▶ Note

- While you select the photo, the printer prints the reserved photos.
- The  appears on the photo included in the print job.

2. Specify number of copies and print settings for each photo.

▶▶▶ Note

- While processing the print job, you cannot change the setting for **Page size** or **Type** on print settings confirmation screen. The setting is the same as the setting for the photo included in the print job.

3. Press **Color** button.

The reserved photo is printed next to the photo that has already been started printing.

If you want to print more photos, operate from step 1 again.

▶▶▶ Note

- While processing the print job, you cannot display the HOME screen, change the print menu, or print from the computer or other devices.
- While processing the print job, the photo in other group is not selected.
- If you press the **Stop** button while processing the print job, the screen to select a method to cancel reservation is displayed. If you select **Cancel all reservations**, you can cancel printing all photos. If you select **Cancel the last reservation**, you can cancel the last printing job.
- If there are many print jobs, **Cannot reserve more print jobs. Please wait a while and redo the operation.** may be displayed on the touch screen. In this case, wait a while and add the print job.

Using Useful Display Functions

You can display the multiple photos at once, specify the date (last modified date of data) to select photos, and switch the photo group.

Select  on the photo selection screen to select the display menu.

- ➔ [Viewing Multiple Photos to Select Photo](#)
- ➔ [Specifying Date to Select Photo](#)
- ➔ [Zooming in on Photo](#)
- ➔ [Switching Photo Group](#)

Viewing Multiple Photos to Select Photo

The following screen is displayed by selecting  on the photo selection screen.

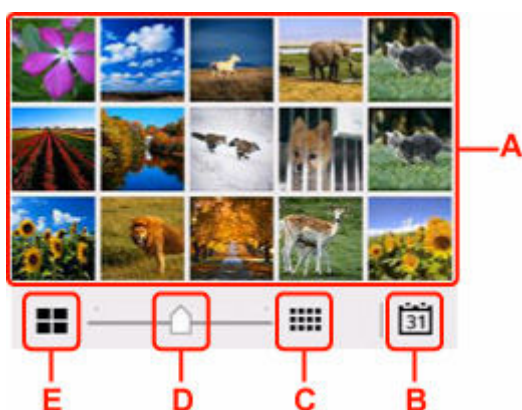

A: When the photo you want to print is selected, the touch screen returns to single photo display.

B: Select to display photo with specifying the date.

- ➔ [Specifying Date to Select Photo](#)

C: Select to increase the display photos. (54 photos display)

D: Drag to switch the number of display photos to 6 photos, 15 photos, or 54 photos.

E: Select to decrease the display photos. (6 photos display)



Specifying Date to Select Photo

The following screen is displayed by selecting  on the photo selection screen.



Flick horizontally to switch the date (update date of photo data).

The photos on date specified are displayed.

You can also select the date by using  and .

▶▶▶ Note

- The date is displayed according to the settings of **Date display format** in **Other printer settings** under **Printer settings**.

➔ [Other printer settings](#)

Zooming in on Photo

The following screen is displayed by selecting  on the photo selection screen.



F: Select to switch the display magnification.

G: Drag to move the display position.

Switching Photo Group

▶▶▶ Note

- If more than 2,000 photo data are saved on the USB flash drive, the photo data is split by group per 2,000 photos in reverse chronological order (date last modified) automatically.

The following screen is displayed by selecting  on the photo selection screen.

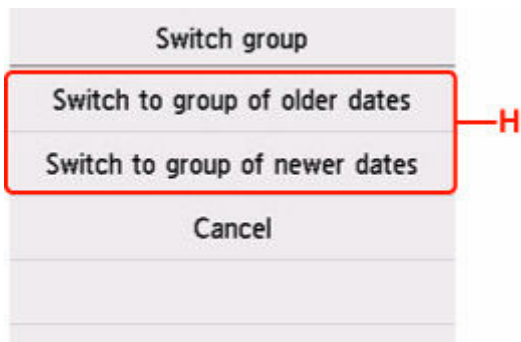

H: Select to switch the photo group.

Printing Documents (PDF) Saved on USB Flash Drive

You can print following PDF files (Extension: .pdf) using the operation panel of the printer.

- PDF files scanned using the operation panel of the printer and saved on a USB flash drive

➔ [Saving Scanned Data on USB Flash Drive](#)

- PDF files made using Canon IJ Scan Utility

For Windows:

➔ [Scanning Documents and Photos](#)

For macOS:

➔ Scanning Documents and Photos

For more on PDF files you cannot print from the printer:

➔ [PDF Files You Cannot Print](#)

Follow the procedure below to print a PDF file.

1. Load paper.

➔ [Loading Rolls in the Printer](#)

➔ [Loading Sheets in the Printer](#)

2. Insert USB flash drive into USB flash drive port.

3. Select  **Others** on the HOME screen.

➔ [Home Screen Menu Composition](#)

4. Select  **Print from**.

5. Select  **Print from USB flash drive**.

The document list is displayed.

▶▶▶ Note

- If both photo files and PDF files are saved on the USB flash drive, the confirmation screen to select which file you print is displayed. Select **Print documents** in the displayed screen.

6. Select document to print.

File name list

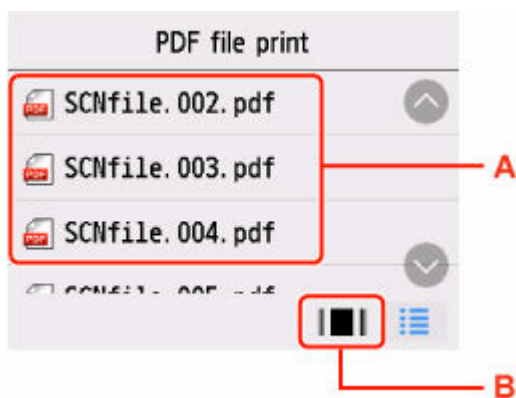

Preview display

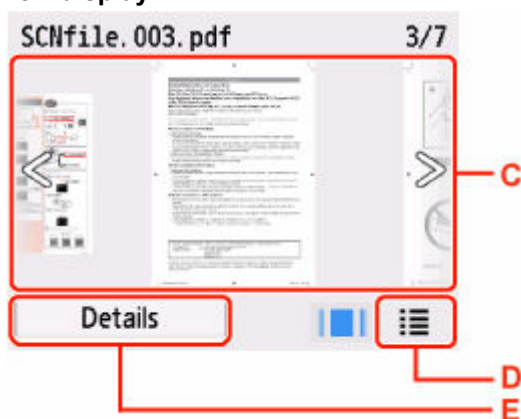

A: Flick vertically to display the name of documents and select document to print.

B: Select to switch to the preview display.

C: Flick to display document preview and select document to print.

D: Select to switch to the file name list.



E: Select to display the **Details** screen.

▶▶▶ Note

- File names may not be displayed properly on the document list if the file name is long or includes incompatible characters.
- On the preview screen, the first page of each PDF file is displayed on the touch screen. Also, if a document is in landscape format, it will be displayed rotated by 90 degrees.
- For some PDF files, it may take longer to display the preview or part of the preview may be cropped.
- The name of the PDF files is displayed even though the PDF files cannot be printed using the operation panel of the printer. If one of the following conditions is applicable to the PDF files, they are not printable.
 - PDF files saved using application software other than Canon IJ Scan Utility
 - PDF files for which the preview screen is not available ("?" is displayed on the preview screen.)
- We recommend you display the **Details** screen and make sure whether a PDF file is printable. If one of the following conditions is applicable to the PDF file, it is not printable.
 - Information on the **Details** screen cannot be displayed.

- Characters other than the printer name or **IJ Scan Utility** are displayed on **Created with**.
- The PDF files made using application software other than Canon IJ Scan Utility are not printable even if they are saved using Canon IJ Scan Utility.

7. Specify settings as necessary.

PDF file print	
Copies	1  1
Paper src	Roll paper
Page size	Letter
Type	Plain paper 

Copies

Specify the number of copies.

Paper src

Select the paper source.

Page size

Select the paper size of the loaded paper.

Type (Media type)

The paper type is set to **Plain paper**.

Print qlty (Print quality)

Specify the print quality.

8. Press the **Black** button or the **Color** button.

The printer starts printing.

▶▶▶ Note

- You can print up to 250 pages at a time. If you try to print more than 250 pages of a PDF file, **The specified PDF file contains too many pages. The pages exceeding the number of printable pages will not be printed. Continue?** is displayed on the touch screen. To start printing, select **Yes**. If you need to print more than 250 pages of a PDF file, print them from a computer.
- Depending on the PDF file, it may be printed rotated by 90 degrees.
- If the document size is larger than the page size specified on the printer, the document will be printed at a reduced size. In this case, thin lines on the document may not be printed or images may be misaligned.

PDF Files You Cannot Print

You cannot print the following PDF files even though the name of the PDF files is displayed on the list.

- Files scanned using the operation panel of the printer and saved on a USB flash drive with **Format** set to other than **PDF** or **Compact PDF**
- Files made using Canon IJ Scan Utility and one of the following conditions is applied

- Encrypted data
- Data more than 2 GB
- Data including images scanned at 9601 pixels or more in the vertical and horizontal directions

Printing from Smartphone/Tablet

For more on printing from a device, refer to the device's or application's instruction manual.

- ▶ **Print Easily from a Smartphone or Tablet with Canon PRINT Inkjet/SELPHY**
- ▶ **Printing from iOS Device (AirPrint)**
- ▶ **Printing with Mopria Print Service**
- ▶ **Printing with Canon Print Service**

Copying

This function is available only for TC-20M.

► Copying to Roll Paper

- Copying to the Roll Width
- Making Enlarged Copies with Basic Settings
- Print a Single Original to Roll Paper Multiple Times Using a Layout
- Reducing/Enlarging Copies
- Copying Thick Originals Such as Books

► Copying to Cut Sheet

- Making Copies
- Reducing/Enlarging Copies
- Copying Two Pages onto Single Page
- Copying Four Pages onto Single Page
- Making Image Stitch Copies
- Copying ID Card to Fit onto Single Page
- Copying Thick Originals Such as Books

Copying to Roll Paper

- **Copying to the Roll Width**
- **Making Enlarged Copies with Basic Settings**
- **Print a Single Original to Roll Paper Multiple Times Using a Layout**
- **Reducing/Enlarging Copies**
- **Copying Thick Originals Such as Books**

Copying to the Roll Width

The original can be enlarged and copied to the width of the roll paper.

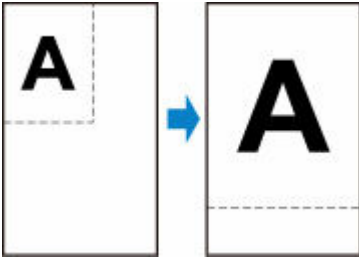

1. Load paper.

➔ [Loading Rolls in the Printer](#)

2. Loading Originals on Document Platen

➔ [Loading Originals on Document Platen](#)

3. Select  **Copy** on the HOME screen.

➔ [Home Screen Menu Composition](#)

▶▶▶ Note

- If both roll paper and cut sheet are loaded, a screen will appear asking which one to use. Select **Copy to roll paper**.

4. Select  **Fit to roll width copy**.

5. On the Copy standby screen, specify settings as necessary.

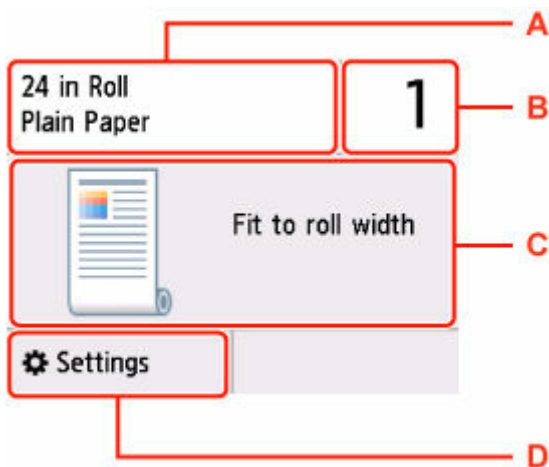

A: The size and type of the loaded paper.

B: Specify the number of copies.



Select the numbers to specify the number of copies.

C: The copy layout.

D: Display the print setting items.

For more on the setting items:

➔ [Setting Items for Copying](#)

6. Press the **Black** button or the **Color** button.

▶▶▶ Note

- To cancel copying, press the **Stop** button.

Making Enlarged Copies with Basic Settings

1. Load paper.

➔ [Loading Rolls in the Printer](#)

2. Loading Originals on Document Platen

➔ [Loading Originals on Document Platen](#)

3. Select  **Copy** on the HOME screen.

➔ [Home Screen Menu Composition](#)

▶▶▶ Note

- If both roll paper and cut sheet are loaded, a screen will appear asking which one to use. Select **Copy to roll paper**.

4. Select  **Enlargement copy**.

5. Select the size you want to enlarge.

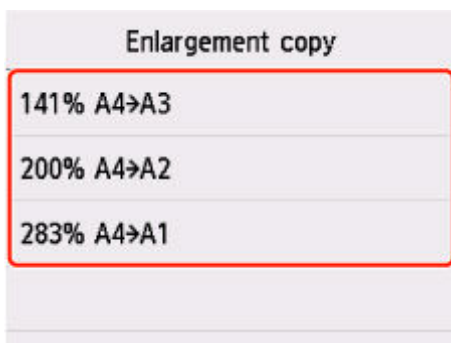

6. On the Copy standby screen, specify settings as necessary.

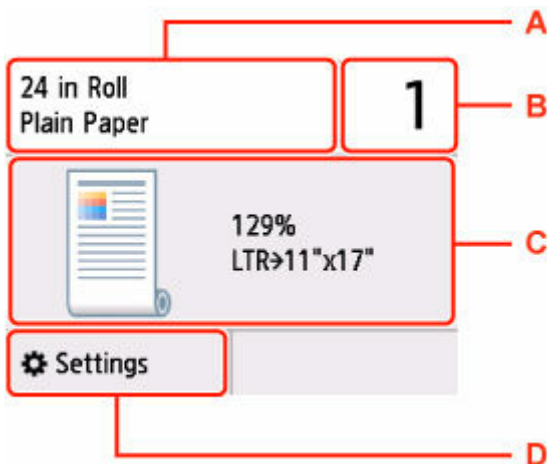

A: The size and type of the loaded paper.

B: Specify the number of copies.



Select the numbers to specify the number of copies.

C: The copy layout.

D: Display the print setting items.

For more on the setting items:

➔ [Setting Items for Copying](#)

7. Press the **Black** button or the **Color** button.

▶▶▶ Note

- To cancel copying, press the **Stop** button.
- You can add the copying job while printing.

➔ [Adding Copying Job \(Reserve copy\)](#)

Print a Single Original to Roll Paper Multiple Times Using a Layout

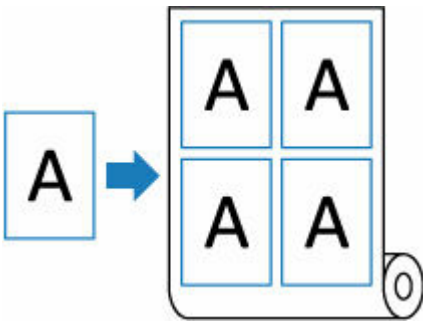

1. Load paper.

➔ [Loading Rolls in the Printer](#)

2. Loading originals on document platen.

➔ [Loading Originals on Document Platen](#)

3. Select  **Copy** on the HOME screen.

➔ [Home Screen Menu Composition](#)

▶▶▶ Note

- If both roll paper and cut sheet are loaded, a screen will appear asking which one to use. Select **Copy to roll paper**.

4. Select  **Repeat copy**.

5. Select **Layout** on the copy standby screen.

Set the layout of the original.

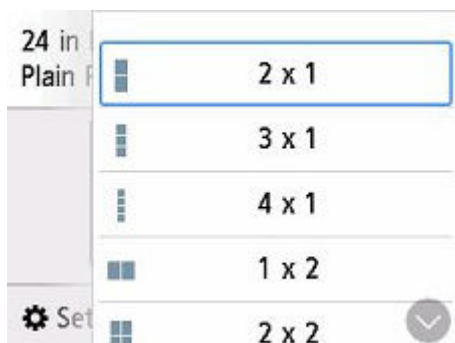

6. Select **Position** on the copy standby screen.

Select the orientation.

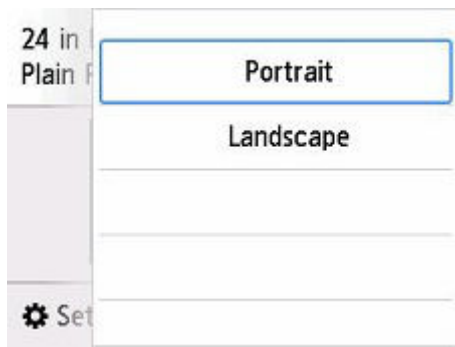

7. On the Copy standby screen, specify settings as necessary.

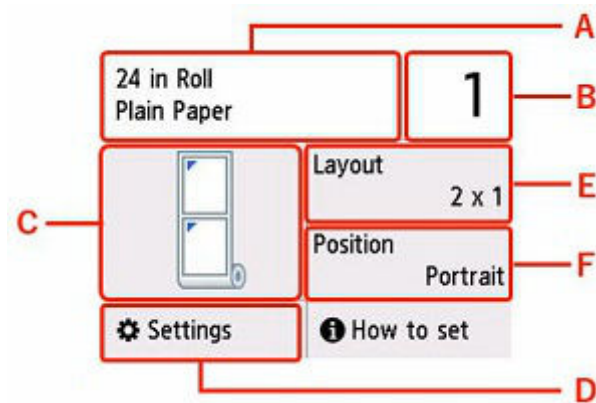

A: The size and type of the loaded paper.

B: Specify the number of copies.



Select the numbers to specify the number of copies.

C: The copy layout.

D: Display the print setting items.

For more on the setting items:

➔ [Setting Items for Copying](#)

E: Set the layout of the original.

F: Select the orientation.

8. Press the **Black** button or the **Color** button.

The printer starts copying.

»» Note

- To cancel copying, press the **Stop** button.

Reducing/Enlarging Copies

You can specify the magnification optionally or select the preset-ratio copying or fit-to-page copying.

NOTE

- You can make enlarged copies on to roll paper easily.
 - ➔ [Making Enlarged Copies with Basic Settings](#)
- You can copy your originals to fit the roll paper width without having to specify the magnification.
 - ➔ [Copying to the Roll Width](#)

1. Load paper.

- ➔ [Loading Rolls in the Printer](#)

2. Loading Originals on Document Platen.

- ➔ [Loading Originals on Document Platen](#)

3. Select **Copy** on the HOME screen.

- ➔ [Home Screen Menu Composition](#)

Note

- If both roll paper and cut sheet are loaded, a screen will appear asking which one to use. Select **Copy to roll paper**.

4. Select **Scaled copy**.

5. Select **Settings**.

6. Select a magnification level in **Magnif.**.

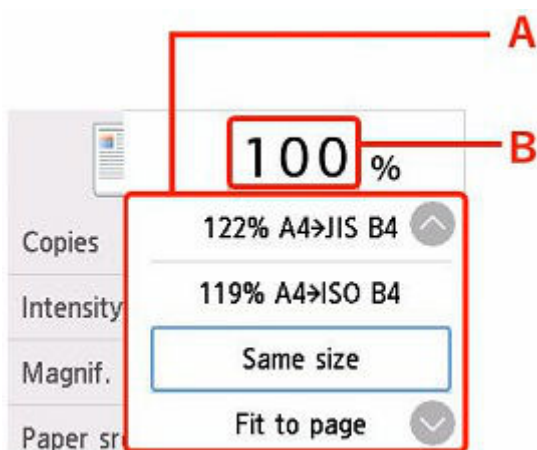

A: Flick to select the reduction/enlargement method.

➔ [Reduction/enlargement Method](#)

B: Select to display the screen below.



Select the numbers to specify the magnification.

7. Select **OK**.

8. On the Copy standby screen, specify settings as necessary.

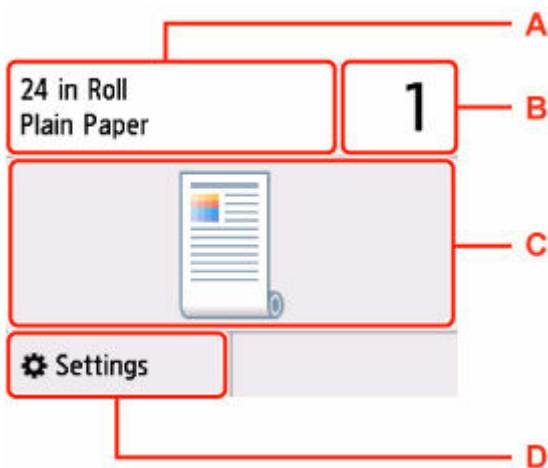

A: The size and type of the loaded paper.

B: Specify the number of copies.



Select the numbers to specify the number of copies.

C: The copy layout.

D: Display the print setting items.

For more on the setting items:

➔ [Setting Items for Copying](#)

9. Press the **Black** button or the **Color** button.

▶▶▶ Note

- To cancel copying, press the **Stop** button.
- You can add the copying job while printing.

➔ [Adding Copying Job \(Reserve copy\)](#)

Reduction/enlargement Method

- Fit to page

The printer automatically reduces or enlarges the image to fit the page size.



The setting in **Magnif.:** **Fit to page**

▶▶▶ Note

- When you select **Fit to page**, the page size may not be detected correctly depending on the original. In this case, select the setting other than **Fit to page**.

- Preset ratio

You can select one of the preset ratios to reduce or enlarge copies.



Select the appropriate ratio for size of original and page size.

▶▶▶ Note

- Some of the preset ratios are not available depending on the country or region of purchase.

- Ratio specified copy

You can specify the copy ratio as a percentage to reduce or enlarge copies.



▶▶▶ Note

- **400% MAX** (maximum copy ratio) and **25% MIN** (minimum copy ratio) are selectable.

- If you make a copy at the same size as the original, select **Same size**.

Copying Thick Originals Such as Books

When copying thick originals such as books, you can make a copy without black margins around the image and gutter shadows. Using this function, you can reduce unnecessary ink consumption.



1. Load paper.

➔ [Loading Rolls in the Printer](#)

2. Load the original on the document platen.

➔ [Loading Originals on Document Platen](#)

3. Select  **Copy** on the HOME screen.

➔ [Home Screen Menu Composition](#)

▶▶▶ Note

- If both roll paper and cut sheet are loaded, a screen will appear asking which one to use. Select **Copy to roll paper**.

4. Select  **Frame erase copy**.

5. On the Copy standby screen, specify settings as necessary.

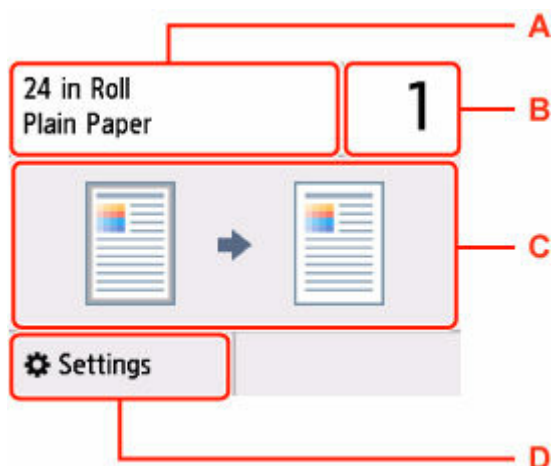

A: The size and type of the loaded paper.

B: Specify the number of copies.



Select the numbers to specify the number of copies.

C: The copy layout.

D: Display the print setting items.

For more on the setting items:

➔ [Setting Items for Copying](#)

6. Press the **Black** button or the **Color** button.

▶▶▶ Note

- Close the document cover.
- There may be a narrow black margin that appears around the image. This function removes the dark margins only. If a scanned book is too thin or when the printer is used near a window or in a bright environment, a faint black frame may remain. Also, if the color of an original is dark, the printer cannot distinguish the document color from the shadow and this may cause slight cropping or a shadow on the crease.
- To cancel copying, press the **Stop** button.

Copying to Cut Sheet

- **Making Copies**
- **Reducing/Enlarging Copies**
- **Copying Two Pages onto Single Page**
- **Copying Four Pages onto Single Page**
- **Making Image Stitch Copies**
- **Copying ID Card to Fit onto Single Page**
- **Copying Thick Originals Such as Books**

Making Copies

This section describes the basic procedure to perform standard copying.

1. Load paper.

➔ [Loading Sheets in the Printer](#)

2. Loading originals on document platen.

➔ [Loading Originals on Document Platen](#)

3. Select  **Copy** on the HOME screen.

➔ [Home Screen Menu Composition](#)

▶▶▶ **Note**

- If both roll paper and cut sheet are loaded, a screen will appear asking which one to use. Select **Copy to cut sheet**.

4. Select  **Standard copy**.

5. On the Copy standby screen, specify settings as necessary.

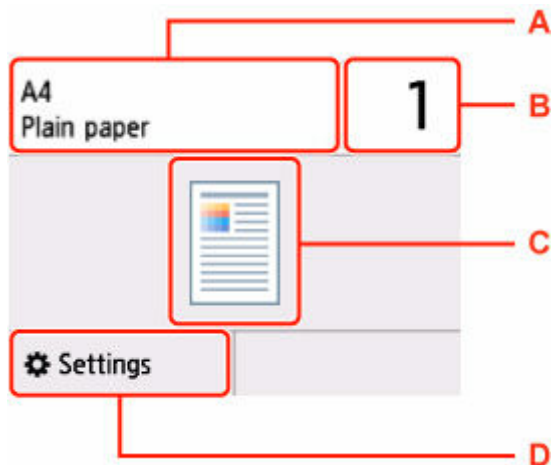

A: The size and type of the loaded paper.

B: Specify the number of copies.

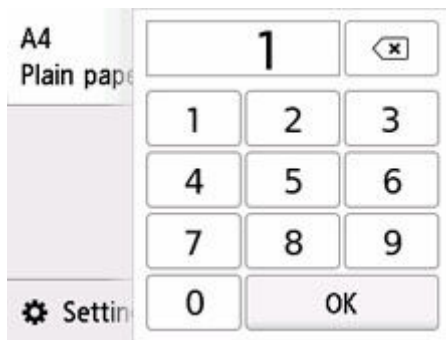

Select the numbers to specify the number of copies.

C: The copy layout.

D: Display the print setting items.

For more on the setting items:

➔ [Setting Items for Copying](#)

6. Press the **Black** button or the **Color** button.

▶▶▶ Important

- Do not open the document cover or remove the original from the platen until scanning is completed.

▶▶▶ Note

- To cancel copying, press the **Stop** button.

Adding Copying Job (Reserve copy)

If you load the original on the platen, you can add the copying job while printing (Reserve copy).

The screen below is displayed when you can add the copying job.

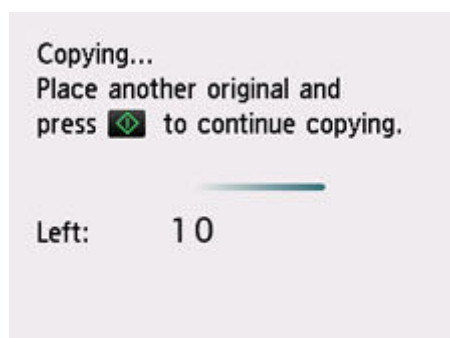

Load the original on the platen and select the same button (**Black** button or **Color** button) as the one which you previously pressed.

▶▶▶ Important

- When you load the original on the platen, move the document cover gently.

▶▶ Note

- When **Print qlty** (print quality) is set **High**, you cannot add the copying job.
- When you add the copying job, the number of copies or the settings such as the page size or media type cannot be changed.
- If you press **Stop** button while reserve copying is in progress, the screen to select the method to cancel copying is displayed. If you select **Cancel all reservations**, you can cancel copying all scanned data. If you select **Cancel the last reservation**, you can cancel the last copying job.
- If you set a document of too many pages to add the copying job, **Cannot add more copy jobs. Please wait a while and redo the operation.** may appear on the touch screen. Select **OK** and wait a while, and then try copying again.
- If **Failed to reserve the copy job. Start over from the beginning.** appears on the touch screen when scanning, select **OK** and press **Stop** button to cancel copying. After that, copy the documents that have not been finished copying.

Setting Items for Copying

You can change the copy settings such as magnification and intensity.

Print Settings Screen

The following screen is displayed by selecting **Settings** in the Copy standby screen.

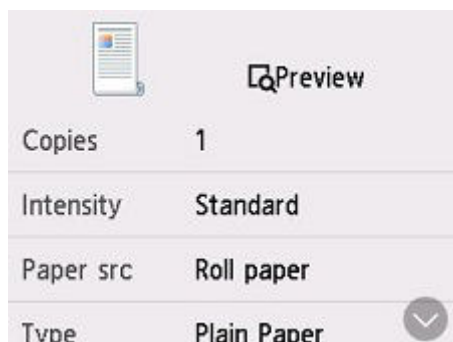

Preview

When **Preview** is displayed on the print settings screen, selecting **Preview** allows you to preview an image of the printout on the preview screen.

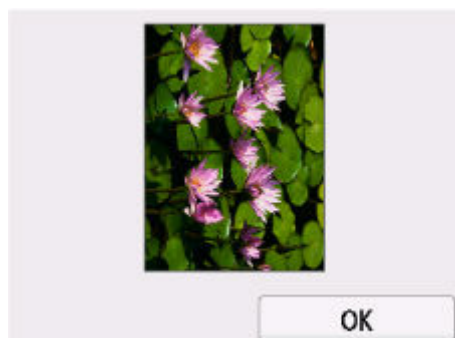

Important



- The original will be scanned to display the preview image. Therefore, do not open the document cover until the preview screen is displayed.
- Originals are rescanned after displaying the preview screen and before copying starts. Therefore, do not open the document cover or remove the original from the platen while **Scanning original...** is displayed.

Setting Items

Flick to display setting items and select the setting item to display the settings. Select to specify the setting.

Note

- The setting items displayed vary depending on the copy function.

- Some settings cannot be specified in combination with the setting of other setting item. If the setting which cannot be specified in combination is selected,  appears on the touch screen. In this case, select  on the upper left on the touch screen to check the message and change the setting.
- The settings of the page size, media type, etc. are retained even if the printer is turned off.
- When copying starts in the copy setting that is not copied, **The specified function is not available with current settings.** is displayed on the touch screen. Change the setting, following the on-screen instructions.

Following setting items can be changed.

- **Copies**

Specify the number of copies.

- **Intensity**

Specify the intensity.

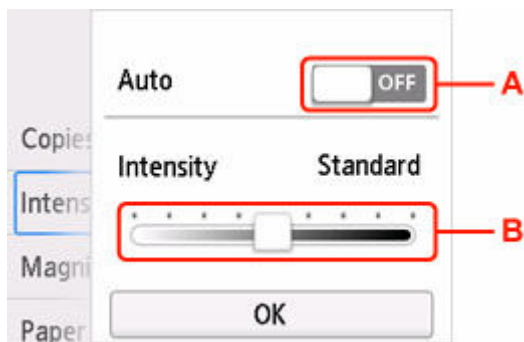

A: Select to activate/deactivate automatic intensity adjustment.

When **ON** is selected, the intensity is adjusted automatically according to the originals loaded on the platen.

B: Drag to specify the intensity.

- **Magnif. (Magnification)**

Specify the reduction/enlargement method.

- ➔ [Reducing/Enlarging Copies](#) (Roll paper)
- ➔ [Reducing/Enlarging Copies](#) (Cut sheet)

- **Original size**

Select the size of the document you want to copy.

- ➔ [Making Image Stitch Copies](#)

- **Paper src**

Select the paper source.

- **Page size**

Select the page size of the loaded paper.

- **Type (Media type)**

Select the media type of the loaded paper.

- **Print qlty** (Print quality)

Adjust print quality according to the original.

»» Important

- If you use **Draft** with **Type** set to **Plain paper** and the quality is not as good as expected, select **Standard** or **High** for **Print qlty** and try copying again.
- Select **High** for **Print qlty** to copy in grayscale. Grayscale renders tones in a range of grays instead of black or white.

- **Layout**

Select the layout.

- ➔ [Copying Two Pages onto Single Page](#)
- ➔ [Copying Four Pages onto Single Page](#)

- **Position**

Select the orientation.

Reducing/Enlarging Copies

You can specify the magnification optionally or select the preset-ratio copying or fit-to-page copying.

1. Load paper.

➔ [Loading Sheets in the Printer](#)

2. Loading Originals on Document Platen.

➔ [Loading Originals on Document Platen](#)

3. Select  **Copy** on the HOME screen.

➔ [Home Screen Menu Composition](#)

▶▶▶ Note

- If both roll paper and cut sheet are loaded, a screen will appear asking which one to use. Select **Copy to cut sheet**.

4. Select  **Standard copy**.

5. Select **Settings**.

6. Select a magnification level in **Magnif..**

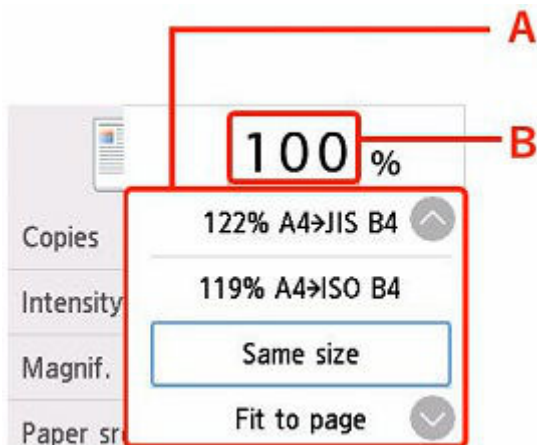

A: Flick to select the reduction/enlargement method.

➔ [Reduction/enlargement Method](#)

B: Select to display the screen below.



Select the numbers to specify the magnification.

7. Select **OK**.

8. On the Copy standby screen, specify settings as necessary.

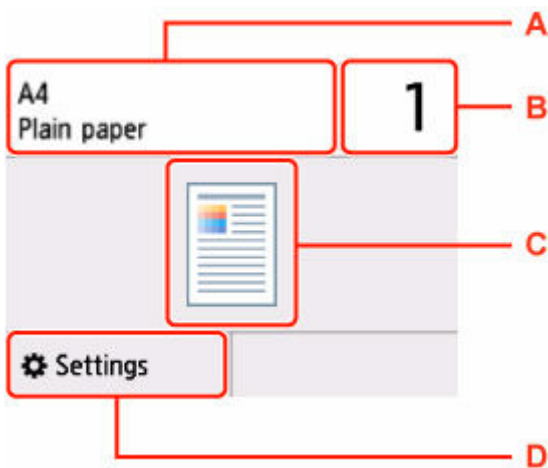

A: The size and type of the loaded paper.

B: Specify the number of copies.



Select the numbers to specify the number of copies.

C: The copy layout.

D: Display the print setting items.

For more on the setting items:

➔ [Setting Items for Copying](#)

9. Press the **Black** button or the **Color** button.

▶▶▶ Note

- To cancel copying, press the **Stop** button.
- You can add the copying job while printing.
 - ➔ [Adding Copying Job \(Reserve copy\)](#)

Reduction/enlargement Method

- Fit to page

The printer automatically reduces or enlarges the image to fit the page size.



The setting in **Magnif.:** **Fit to page**

▶▶▶ Note

- When you select **Fit to page**, the page size may not be detected correctly depending on the original. In this case, select the setting other than **Fit to page**.

- Preset ratio

You can select one of the preset ratios to reduce or enlarge copies.



Select the appropriate ratio for size of original and page size.

▶▶▶ Note

- Some of the preset ratios are not available depending on the country or region of purchase.

- Ratio specified copy

You can specify the copy ratio as a percentage to reduce or enlarge copies.

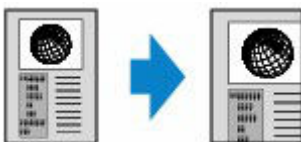

▶▶▶ Note

- **400% MAX** (maximum copy ratio) and **25% MIN** (minimum copy ratio) are selectable.
- If you make a copy at the same size as the original, select **Same size**.

Copying Two Pages onto Single Page

You can copy two original pages onto a single sheet of paper by reducing each image.

1. Load paper.

➔ [Loading Sheets in the Printer](#)

2. Loading Originals on Document Platen.

➔ [Loading Originals on Document Platen](#)

3. Select  **Copy** on the HOME screen.

➔ [Home Screen Menu Composition](#)

▶▶▶ Note

- If both roll paper and cut sheet are loaded, a screen will appear asking which one to use. Select **Copy to cut sheet**.

4. Select  **Layout copy**.

5. Select **Settings**.

6. Select **2-on-1 copy** in **Layout**.

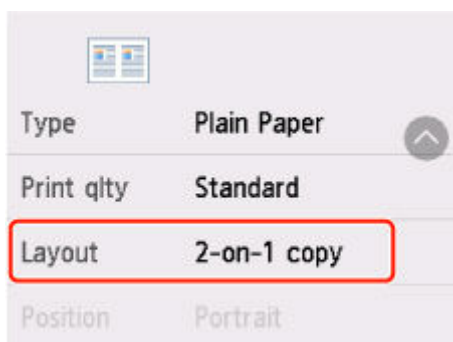

7. Select **Advanced**.

Specify the orientation and order of originals.

- When you select **Orientation: Portrait** and **Left to right**:



- When you select **Orientation: Portrait** and **Right to left**:



- When you select **Orientation: Landscape** and **Top to bottom:**



- When you select **Orientation: Landscape** and **Bottom to top:**

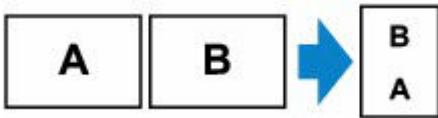

5. Select whether or not to show the preview screen.

If you select **ON**, the preview screen is displayed so that you can check the orientation and order of the originals.

6. Select **OK**.

7. On the Copy standby screen, specify settings as necessary.

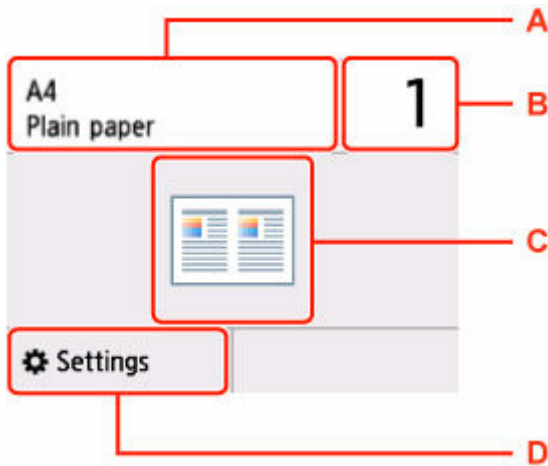

A: The size and type of the loaded paper.

B: Specify the number of copies.



Select the numbers to specify the number of copies.

C: The copy layout.

D: Display the print setting items.

For more on the setting items:

➔ [Setting Items for Copying](#)

8. Press the **Black button or the **Color** button.**

When the first sheet of the original has been scanned, the following screen is displayed.

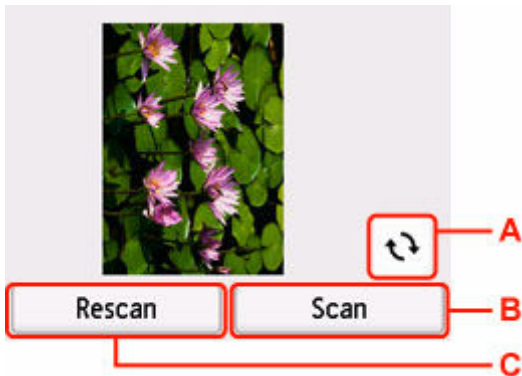

A: Select to rotate the original by 180 degrees.

B: Select to start scanning the original.

C: Select to rescan the original.

9. Check the preview screen and select **Scan.**

The screen below appears after scanning the first sheet of original.

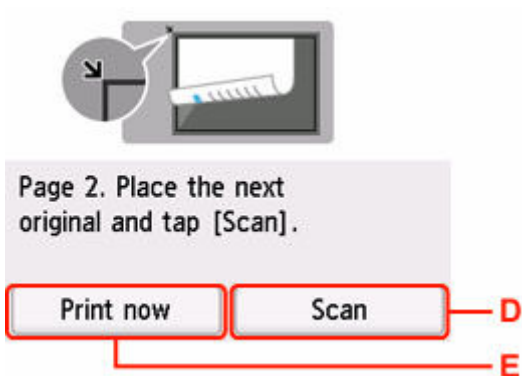

D: Select to start scanning the original.

E: Select to start copying the original already scanned.

10. Load the second sheet of the original on the platen and select **Scan.**

11. Check the preview screen and select **Scan.**

The printer starts scanning the second sheet of original and copying.

»» Note

- If **Cannot process because device memory is full.** appears on the touch screen when scanning, set **Print qlty** to **Standard** and try copying again. If the problem is not resolved when **Media type** is set to **Plain paper**, set **Print qlty** to **Draft** and try copying again.
- To cancel copying, press the **Stop** button.
- You can add the copying job while printing.
 - ➔ [Adding Copying Job \(Reserve copy\)](#)

Copying Four Pages onto Single Page

You can copy four original pages onto a single sheet of paper by reducing each image. Four different layouts are available.

1. Load paper.

➔ [Loading Sheets in the Printer](#)

2. Loading Originals on Document Platen.

➔ [Loading Originals on Document Platen](#)

3. Select  **Copy** on the HOME screen.

➔ [Home Screen Menu Composition](#)

▶▶▶ Note

- If both roll paper and cut sheet are loaded, a screen will appear asking which one to use. Select **Copy to cut sheet**.

4. Select  **Layout copy**.

5. Select **Settings**.

6. Select **4-on-1 copy** in **Layout**.



7. Select **Advanced**.

Specify the orientation and order of originals.

▶▶▶ Note

- The order is the same regardless of the orientation.
- When you select **Upper-left to right**

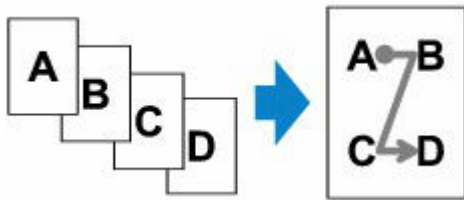

- When you select **Upper-right to left**

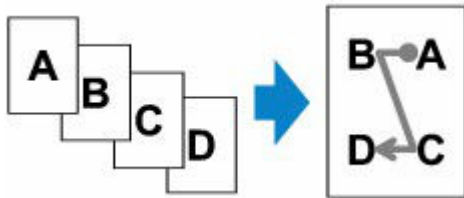

- When you select **Upper-left to bottom**

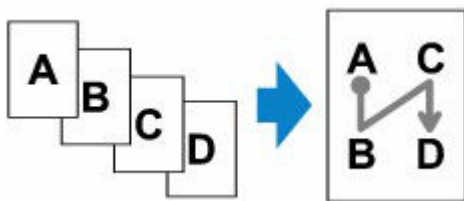

- When you select **Upper-right to bottom**

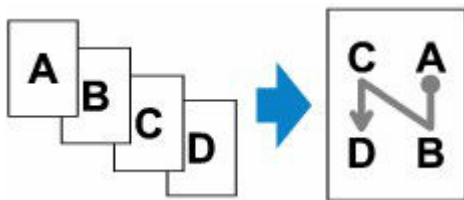

8. Select whether or not to show the preview screen.

If you select **ON**, the preview screen is displayed so that you can check the orientation and order of the originals.

9. Select **OK**.

10. On the Copy standby screen, specify settings as necessary.

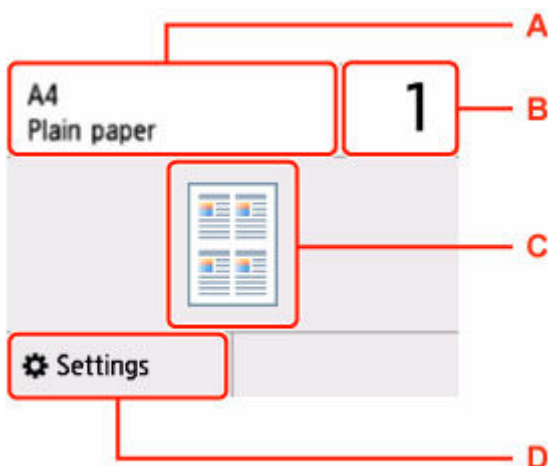

A: The size and type of the loaded paper.

B: Specify the number of copies.

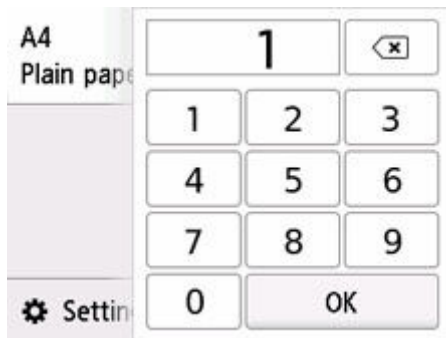

Select the numbers to specify the number of copies.

C: The copy layout.

D: Display the print setting items.

For more on the setting items:

➔ [Setting Items for Copying](#)

11. Press the **Black** button or the **Color** button.

When the first sheet of the original has been scanned, the following screen is displayed.

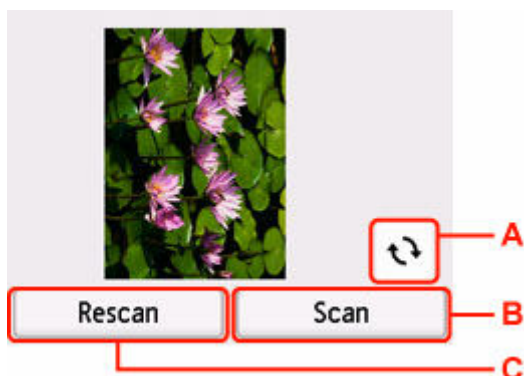

A: Select to rotate the original by 180 degrees.

B: Select to start scanning the original.

C: Select to rescan the original.

12. Check the preview screen and select **Scan**.

The screen below appears after scanning each sheet of original.

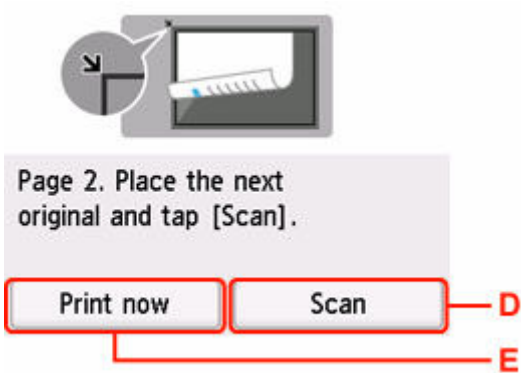

D: Select to start scanning the original.

E: Select to start copying the original already scanned.

13. Load the second sheet of the original on the document platen and select **Scan**.

14. Check the preview screen and select **Scan**.

15. Repeat steps 13 and 14 to scan the third and fourth sheets of originals.

After scanning the fourth sheet of original, the printer starts copying.

»» Note

- If **Device memory is full. Cannot continue process.** appears on the touch screen when scanning, set **Print qlty** to **Standard** and try copying again. If the problem is not resolved when **Media type** is set to **Plain paper**, set **Print qlty** to **Draft** and try copying again.
- To cancel copying, press the **Stop** button.
- You can add the copying job while printing.
 - ➔ [Adding Copying Job \(Reserve copy\)](#)

Making Image Stitch Copies

You can scan oversized originals in two halves and then print them onto a single sheet.

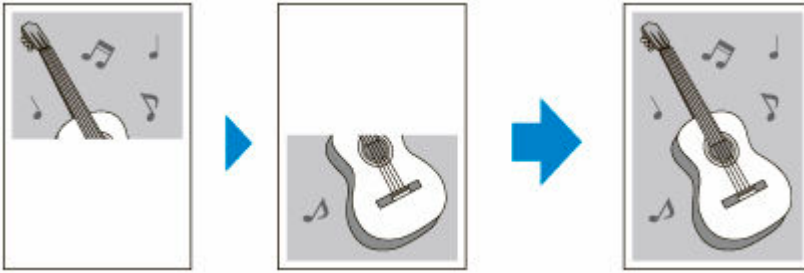

1. Load paper.

➔ [Loading Sheets in the Printer](#)

2. Select  **Copy** on the HOME screen.

➔ [Home Screen Menu Composition](#)

▶▶▶ Note

- If both roll paper and cut sheet are loaded, a screen will appear asking which one to use. Select **Copy to cut sheet**.

3. Select  **Image stitch copy**.

4. Check message and select **OK**.

5. Select the size of the original.

6. Select page size to print onto.

7. Loading Originals on Document Platen

➔ [Loading Originals on Document Platen](#)

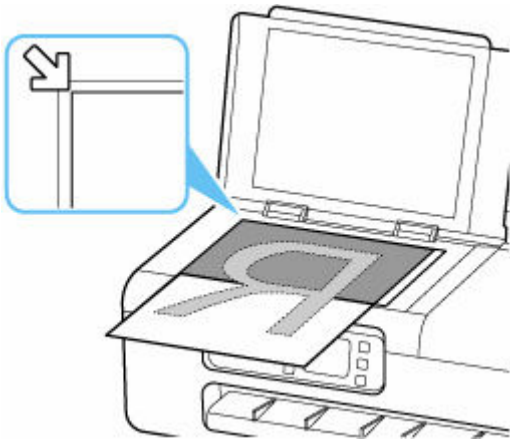

8. Check message and select **OK**.
9. On the Copy standby screen, specify settings as necessary.

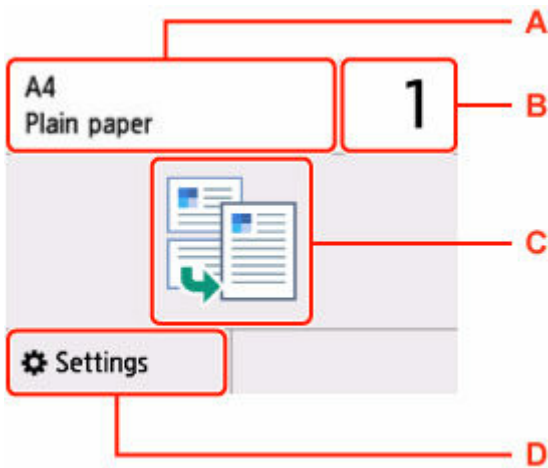

A: The size and type of the loaded paper.

B: Specify the number of copies.

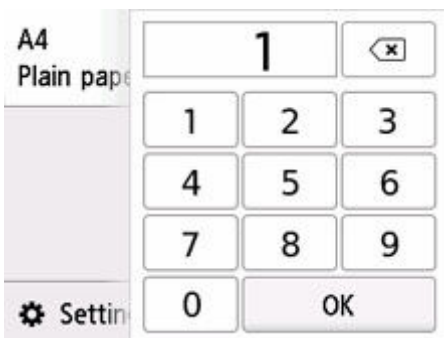

Select the numbers to specify the number of copies.

C: The copy layout.

D: Display the print setting items.

For more on the setting items:

➔ [Setting Items for Copying](#)

10. Press the **Black** button or the **Color** button.

The printer starts scanning of the first half of the original.

When scanning of the original is finished, the printer beeps.

11. Rotate the oversized original 180 degrees to place its other half on platen, and then align it with alignment mark (📏).

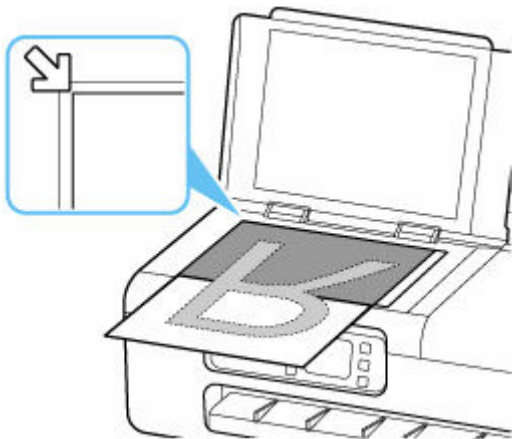

12. Check the message, and select **Scan**.

The printer scans the other half of the oversized original and starts copying.

▶▶▶ Note

- To cancel copying, press the **Stop** button.
- White lines or image misalignment may occur in the center of the copy due to the contents of the original or how it was placed. If the print results are not as expected, try Canon IJ Scan Utility (Windows) or Canon IJ Scan Utility Lite (macOS) located on the computer.
 - ➡ [Scanning Originals Larger than the Platen \(Image Stitch\)](#) (Windows)
 - ➡ [Scanning Originals Larger than the Platen \(Image Stitch\)](#) (macOS)

Copying ID Card to Fit onto Single Page

You can copy a card sized original such as an ID card onto a single sheet of paper consecutively.

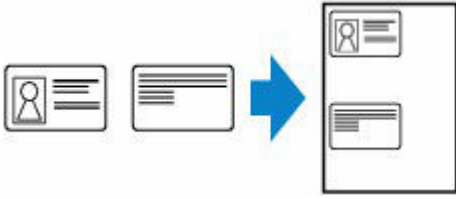

1. Load paper.

➔ [Loading Sheets in the Printer](#)

2. Select  **Copy** on the HOME screen.

➔ [Home Screen Menu Composition](#)

▶▶▶ Note

- If both roll paper and cut sheet are loaded, a screen will appear asking which one to use. Select **Copy to cut sheet**.

3. Select  **ID card copy**.

4. Check message and select **OK**.

5. On the Copy standby screen, specify settings as necessary.

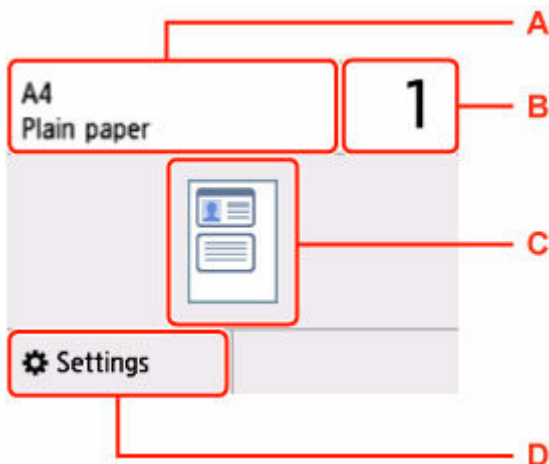

A: The size and type of the loaded paper.

B: Specify the number of copies.

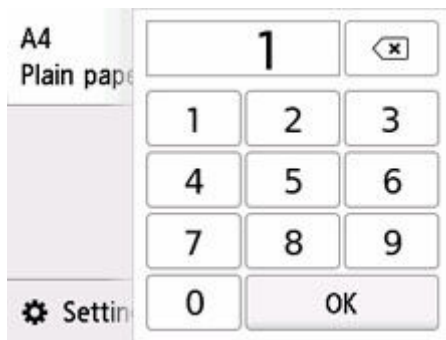

Select the numbers to specify the number of copies.

C: The copy layout.

D: Display the print setting items.

For more on the setting items:

➔ [Setting Items for Copying](#)

▶▶▶ Note

- If you select **Preview** in the print settings screen, you can check printing result of the front side.

➔ [Using Preview Screen to Check Printing Result of Front Side](#)

6. Press the **Black** button or the **Color** button.

7. Load the original on the document platen.

➔ [Loading Originals on Document Platen](#)



Place the ID card face up on the document platen as shown and tap [Scan].

Scan

Follow the on-screen instructions to load the original.

8. Select **Scan**.

9. Turn the original over and set it on the document platen.



Follow the on-screen instructions to load the original.

10. Select **OK**.

▶▶▶ Note

- To cancel copying, press the **Stop** button.

Using Preview Screen to Check Printing Result of Front Side

Selecting **Preview** in the print setting screen displays how to load the original. Loading the original following the on-screen instructions and selecting **Scan** displays the preview screen to check the printing result of the front side.



Selecting **OK** on the preview screen returns to print settings screen.

Pressing the **Color** button or **Black** button starts scanning the front side.

Copying Thick Originals Such as Books

When copying thick originals such as books, you can make a copy without black margins around the image and gutter shadows. Using this function, you can reduce unnecessary ink consumption.

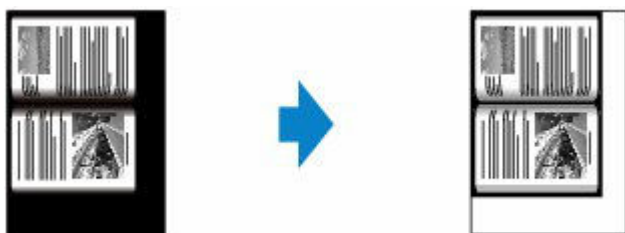

1. Load paper.

➔ [Loading Sheets in the Printer](#)

2. Load the original on the document platen.

➔ [Loading Originals on Document Platen](#)

3. Select  **Copy** on the HOME screen.

➔ [Home Screen Menu Composition](#)

▶▶▶ Note

- If both roll paper and cut sheet are loaded, a screen will appear asking which one to use. Select **Copy to cut sheet**.

4. Select  **Frame erase copy**.

5. On the Copy standby screen, specify settings as necessary.

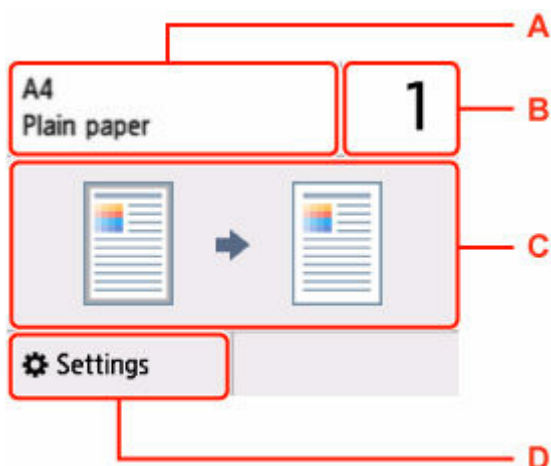

A: The size and type of the loaded paper.

B: Specify the number of copies.

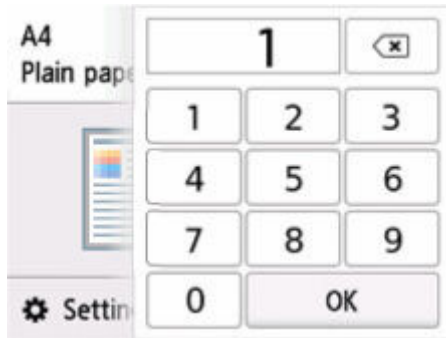

Select the numbers to specify the number of copies.

C: The copy layout.

D: Display the print setting items.

For more on the setting items:

➡ [Setting Items for Copying](#)

6. Press the **Black** button or the **Color** button.

▶▶▶ Note

- Close the document cover.
- There may be a narrow black margin that appears around the image. This function removes the dark margins only. If a scanned book is too thin or when the printer is used near a window or in a bright environment, a faint black frame may remain. Also, if the color of an original is dark, the printer cannot distinguish the document color from the shadow and this may cause slight cropping or a shadow on the crease.
- To cancel copying, press the **Stop** button.

Scanning

This function is available only for TC-20M.

- **Saving Scanned Data to Your Computer** 📄 Basics
- **Sending Scanned Data as E-Mail from Printer**
- **Sending Scanned Data as E-Mail from Computer**
- **Saving Scanned Data on USB Flash Drive**
- **Forwarding Scanned Data to Shared Folder on Computer**
- **Scanning with a Computer Application**
 - Scanning with Windows
 - Scanning with macOS

Saving Scanned Data to Your Computer

Before saving the scanned data to the computer, check the following:

- **Printer driver is installed. (Windows)**

If the printer driver is not installed yet, install the printer driver from the Setup CD-ROM or the Canon website.

➔ [Installing the Printer Driver](#)

- **When scanning via a network connection**

Make sure the printer is connected to the computer correctly.

- For Windows:

➔ [Network Scan Settings](#)

- For macOS:

➔ Scan-from-Operation-Panel Settings Screen

Follow the procedure below to save scanned data to the computer.

1. Loading Originals on Document Platen

➔ [Loading Originals on Document Platen](#)

2. Select  **Others** on the HOME screen.

➔ [Home Screen Menu Composition](#)

3. Select  **Scan**.

4. Select  **Save to computer**.

5. Select where to save the scanned data.

Select **Local (USB)** for a USB-connected computer, or select the computer to save the scanned data for a network-connected computer.



6. On the Scan standby screen, specify the settings as necessary.

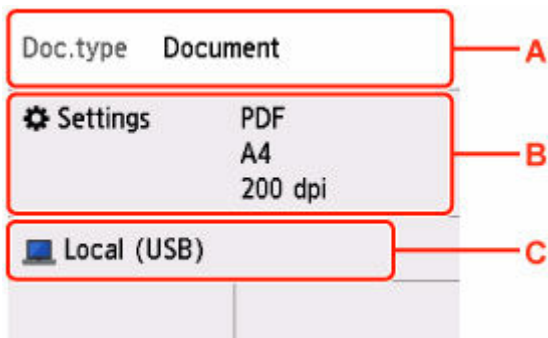

A: Select the document type.

Document

Select to scan the document.

Photo

Select to scan the photo.

B: Displays **Scan settings** screen.

For more on the setting items:

➔ [Setting Items for Scanning Using Operation Panel](#)

C: Displays the screen to select the save.

7. Press the **Black** button or the **Color** button.

▶▶▶ **Note**

- If the original is not loaded properly, a message is displayed on the touch screen. Load the original on the platen according to the scan settings.
- When you select **JPEG** or **TIFF** for **Format** on the scan setting screen:
The printer starts scanning and scanned data is saved to the computer.
- When you select **PDF** or **Compact PDF** for **Format** on the scan setting screen:
The confirmation screen asking you if you continue scanning is displayed after scanning is complete.



If you continue scanning, load the original on the platen and start scanning.

If you do not continue scanning, select **End**. The scanned data is saved to the computer in one PDF file.

Scanned data is saved to the computer according to the settings specified in Canon IJ Scan Utility/
Canon IJ Scan Utility Lite.

▶▶▶ Note



- You can use the following scanning method.
 - **Scanning with a WIA-compliant application software (Windows)**
For details:
 - ➡ [Scanning with WIA Driver](#)
 - **Converting a scanned document to text (OCR)**
For details:
 - For Windows:
 - ➡ [Extracting Text from Scanned Images \(OCR\)\(Windows\)](#)
 - For macOS:
 - ➡ [Extracting Text from Scanned Images \(OCR\)\(macOS\)](#)
 - **Forwarding the scanned data to the computer using WSD (one of the network protocols supported in Windows)**
 - ➡ [WSD scan from this printer](#)
- When using Windows, the program selection screen may be displayed after pressing **Black** button or **Color** button.
In this case, select **Canon IJ Scan Utility** and click **OK**.
- You can change where scanned data is saved and the file name by using Canon IJ Scan Utility (Windows) or Canon IJ Scan Utility Lite (macOS). For the settings of Canon IJ Scan Utility and Canon IJ Scan Utility Lite, see the following.
 - For Windows:
 - ➡ [Settings Dialog Box](#)
 - For macOS:
 - ➡ [Settings Dialog](#)
- Canon IJ Scan Utility (Windows) or Canon IJ Scan Utility Lite (macOS) allows you to specify how to respond when scanning from the operation panel. For more on settings of Canon IJ Scan Utility/Canon IJ Scan Utility Lite:
 - For Windows:
 - ➡ [Setting Up Operation Panel with IJ Scan Utility \(Windows\)](#)
 - For macOS:
 - ➡ [Setting Up Operation Panel with IJ Scan Utility Lite \(macOS\)](#)

Setting Items for Scanning Using Operation Panel

You can change the scan settings such as the scan size, resolution, or data format.

When the Scan standby screen is displayed, select **Scan settings** to select the setting item. Flick to display setting items and select the setting item to display the settings. Select to specify the setting.

▶▶▶ Note

- The scan setting cannot be specified under the following conditions:
 - When you forward the scanned data to the computer using WSD (one of the network protocols supported in Windows)
- Some settings cannot be specified in combination with the setting of other setting item, the document type selected for **Doc.type**, or the scan menu on the screen for selecting to which you save the data. If the setting which cannot be specified in combination is selected,  and **Error details** are displayed on the touch screen. In this case, select  on the upper left on the touch screen to check the message and change the setting.
- The specified scan settings such as the scan size, resolution, and data format are retained even if the printer is turned off.
- When scanning starts in the scan menu that is not available with the specified setting, **The specified function is not available with current settings.** is displayed on the touch screen. Change the setting, following the on-screen instructions.
- When you save the scanned data to the computer or attach the data to an e-mail, you can specify the destination and file name using Canon IJ Scan Utility (Windows)/Canon IJ Scan Utility Lite (macOS).
 - For Windows:
 - ➡ [Settings Dialog Box](#)
 - For macOS:
 - ➡ Settings Dialog
- If you scan originals from the computer, you can scan with advanced settings. For more on scanning from the computer:
 - For Windows:
 - ➡ [Scanning with Windows](#)
 - For macOS:
 - ➡ Scanning with macOS

Scan settings	
Scan size	A4
Format	PDF
Scan res	200 dpi
Preview	OFF 

- **Scan size**

Select the size of the original.

- **Format**

Select the data format of the scanned data.

- **Scan res** (Scan resolution)

Select the resolution for scanning.

- **Preview**

Select to preview the scanned data or not when saving the data on a USB flash drive.

- **Reduce show-thru** (Reducing show-through)

Characters on the back may show through when scanning a thin document such as a newspaper.

Select **ON** if characters seem to show through on the scanned document.

This setting item is not available when **Photo** is selected for **Doc.type**.

- **Descreen**

A printout consists of minute dots to make characters or graphs. Interfering with each dot may result in uneven shades or a striped pattern. Select **ON** if you notice any uneven shades or a striped pattern on the scanned image.

This setting item is not available when **Photo** is selected for **Doc.type**.

▶▶▶ Note

- Even if **ON** is selected for this setting, some moire effects may remain if **Unsharp mask** is set to **ON**. In that case, select **OFF** for **Unsharp mask**.

- **Unsharp mask**

The outline of small characters or thin objects such as a hair or leaves on a photo can be accentuated. Select **ON** if you want to accentuate the outline of the scanned data.

▶▶▶ Important

- For macOS, the unsharp mask function does not work even if you select **ON**.

Sending Scanned Data as E-Mail from Printer

- **Sending Scanned Data as E-Mail from Printer**
- **Registering Recipients' E-Mail Address**
- **Registering Recipients in Group E-Mail**
- **Changing Registered Information**
- **Deleting Registered Information**
- **Importing/Exporting E-Mail Address Book**

Sending Scanned Data as E-Mail from Printer

You can send scanned data as an e-mail from the printer.

1. Configure the mail server settings in the remote UI.

➔ [Setting Mail Server](#)

2. Loading Originals on Document Platen

➔ [Loading Originals on Document Platen](#)

3. Select  **Others** on the HOME screen.

➔ [Home Screen Menu Composition](#)

4. Select  **Scan**.

5. Select  **Attach to email**.

6. Select  **E-mail directly from device**.

7. Select **Select recipients**.

8. Specify recipient(s).

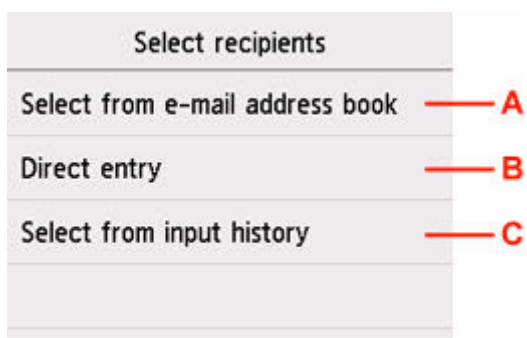

A: Select the recipient(s) from the address book.

B: Enter recipient's e-mail address.

C: Select the recipient(s) from the input history.

9. Perform mail sending settings.

The screen below appears.

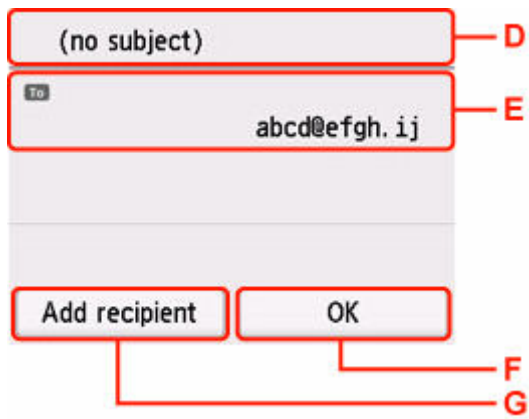

D: Enter the subject.

E: Select the items below.

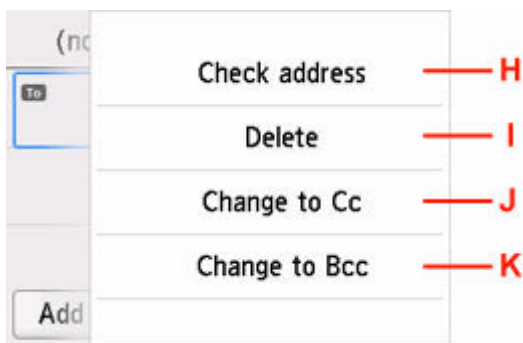

H: Check the address. Selecting **Edit** allows you to change the address.

I: Selecting **Yes** deletes the recipient.

J: Select to change to Cc (carbon copy).

K: Select to change to Bcc (blind carbon copy).

»»» **Note**

- To change Cc or Bcc to To, Select the recipient and select **Change to To**.

F: Complete specifying the recipient.

G: Add the recipient.

10. Specify settings as necessary.

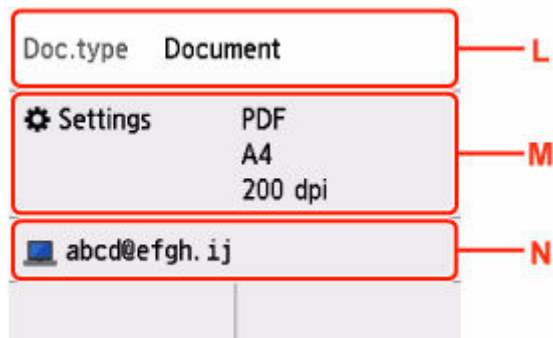

L: Select the document type.

Document

Select to scan the document.

Photo

Select to scan the photo.

M: Displays **Scan settings** screen.

For more on the setting items:

➔ [Setting Items for Scanning Using Operation Panel](#)

N: Changes the destination of e-mail/screen.

11. Press the **Black** button or the **Color** button.

▶▶▶ Note

- If the original is not loaded properly, a message is displayed on the touch screen. Load the original on the platen according to the scan settings.

- **If you select ON for Preview on the scan setting screen:**

The preview screen is displayed before sending the scanned original as an e-mail.

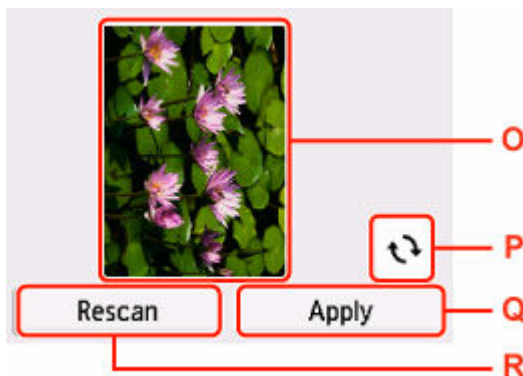

O: The preview screen of the scanning data is displayed.

P: Select to rotate the preview screen.

Displayed when you select **PDF** or **Compact PDF** for **Format** on the scan setting screen.

Q: Select to send the scanned original as an e-mail.

R: Select to rescan the original.

- **When you select JPEG for Format on the scan setting screen:**

The printer starts scanning and scanned data is sent as an e-mail.

- **When you select PDF or Compact PDF for Format on the scan setting screen:**

The confirmation screen asking you if you continue scanning is displayed after scanning is complete.



If you continue scanning, load the original on the platen and start scanning.

If you do not continue scanning, select **End**. The scanned data is sent as an e-mail in one PDF file.

Checking Send Log

Selecting **Check send log** on **E-mail directly from device** displays the items below.

- **Display send log**

Displays the send log of the printer (up to 100). Select the item to check more information.

- **Print send log**

Prints out the send log of the printer. Select **Yes** to start printing.

▶▶▶ Note

- When sending scanned data as an e-mail attachment, you can specify the subject line, body text, and attachment file size limit using the remote UI.

➔ [Specifying Mail Setting for Sending Scanned Data](#)

Registering Recipients' E-Mail Address

Before you can use the printer's address book, you need to register the recipients' e-mail address. Follow the procedure below to register the recipients' e-mail address.

1. Select  **Others** on the HOME screen.

➔ [Home Screen Menu Composition](#)

2. Select  **Scan**.

3. Select  **Attach to E-mail**.

4. Select  **E-mail directly from device**.

5. Select **Edit e-mail address book**.

6. Select **Display e-mail address book**.

The screen to select an ID number is displayed.

E-mail address book (by ID)	
00	-----
01	-----
02	-----
..	-----

▼

🔍 New entry

▶▶▶ Note

- If you already registered the recipients, the recipients' name is displayed next to the ID number.
If you already registered the group mail,  and the group name are displayed next to the ID number.

7. Select unregistered ID number.

▶▶▶ Note

- If you already registered the recipients and they are displayed by name, select **Switch view**. The registered recipients are displayed by ID number.
- If you select **New entry**, an unregistered ID number will be selected in numerical order.

8. Select Register e-mail address.

9. Select registration method.

- **Direct entry**

The screen to register the recipient's e-mail address and name is displayed. Go to next step.

The screenshot shows a screen titled "E-mail address book 00". It contains two input fields. The first field is labeled "Name" and the second is labeled "E-mail address". Both fields have a small icon of a person and a mail envelope to their left, indicating they are for entering a name and an email address respectively.

- **Select from send log**

When you select this registration method, the screen to select the e-mail address from the send logs is displayed.

The screenshot shows a screen titled "Select from send log". It displays a list of three email addresses: "cdef@ghij.kl", "bcde@fghi.jk", and "abcd@efgh.ij". Each address is on a separate line, and there is a blank line at the bottom of the list.

Selecting an e-mail address from the send logs, the screen to register the recipient's e-mail address and name is displayed. Go to next step.

10. Enter recipient's name.

1. Select entry field of name.

The screen to enter the character is displayed.

2. Enter recipient's name.

The screenshot shows a character entry screen. At the top, there is a text field containing "L. George" with a cursor at the end. Below the text field are several buttons for character selection: "abc", "def", "ghi", "jkl", "mno", "pqrs", "tuv", "wxyz", ".@-", and "OK". There are also navigation buttons (left and right arrows) and a delete button (X) on the right side.

3. Select **OK**.

»»» **Note**

- You can enter the name up to 16 characters, including spaces.

11. Enter recipient's e-mail address.

If you select an e-mail address on **Select from send log**, the e-mail address is already entered. If you do not change the e-mail address, go to next step.

1. Select entry field of e-mail address.
2. Enter recipient's mail address.



3. Select **OK**.

»»» **Note**

- You can enter the e-mail address up to 60 characters (40 characters for the US, Canada, Korea and some regions of Latin America), including spaces.

12. Select **Register to finalize registration.**

»»» **Note**

- To register another recipient's number and name, select an unregistered ID number and operate in the same procedure.

Registering Recipients in Group E-Mail

If you register two or more registered e-mail address to a group e-mail, you can send the same mail successively to all recipients registered to the group e-mail.

1. Select  **Others** on the HOME screen.

➔ [Home Screen Menu Composition](#)

2. Select  **Scan**.

3. Select  **Attach to email**

4. Select  **E-mail directly from device**.

5. Select **Edit e-mail address book**.

6. Select **Display e-mail address book**.

The screen to select an ID number is displayed.

E-mail address book (by ID)	
00	L. George
01	Alice
02	D. V. Michael
03	

Switch view 🔍 New entry

▶▶▶ Note

- If you already registered the recipients, the recipients' name is displayed next to the ID number.
If you already registered the group mail,  and the group name are displayed next to the ID number.

7. Select unregistered ID number.

▶▶▶ Note

- If you already registered the recipients and they are displayed by name, select **Switch view**. The registered recipients are displayed by ID number.
- If you select **New entry**, an unregistered ID number will be selected in numerical order.

8. Select Register group e-mail.

The screen to register the group name and the member of the group is displayed.

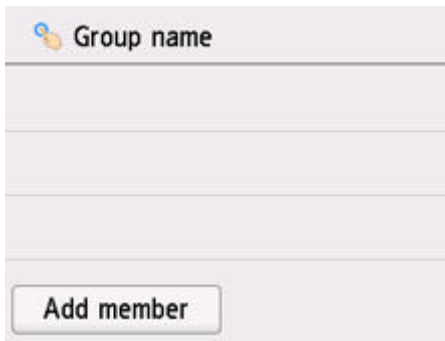

9. Enter group name.

1. Select entry field of group name.

The screen to enter the character is displayed.

2. Enter group name.



3. Select **OK**.

▶▶▶ Note

- You can enter the name up to 16 characters, including spaces.

10. Register the registered recipient as a member of the group e-mail.

1. Select **Add member**.

The address book is displayed.

Display by name

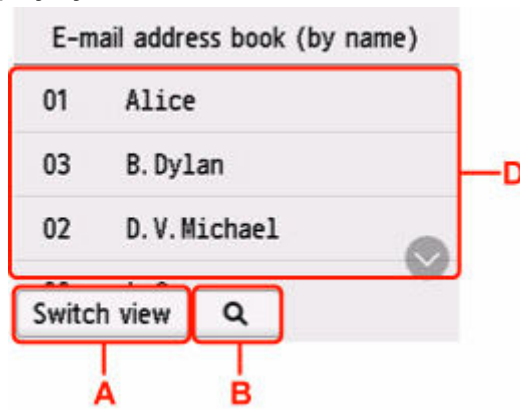

Display by ID number

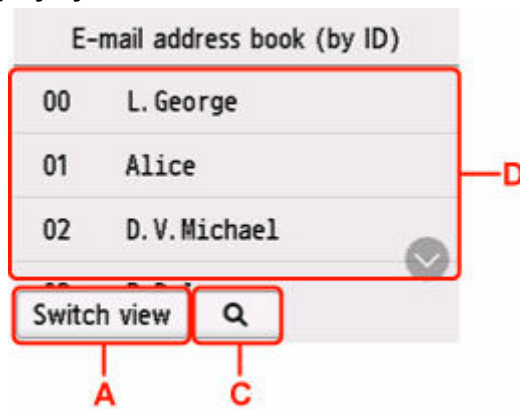

A: Select to switch the display by name and by ID number.

B: Select to display the screen to select an initial. You can search the registered recipient by initial.



By selecting the initial, the registered recipients are displayed in alphabetical order from the selected character.

C: Select to display the screen to select an ID number of the registered recipient. You can search the registered recipient by ID number.



By entering the ID number and selecting **OK**, the registered recipients are displayed in order from the recipient of the ID number selected.

D: The recipients that can be registered are displayed.

2. Select recipient to register as group member.

The member to register is displayed on the list.



▶▶▶ Note

- To delete the recipient from the group e-mail, select a recipient that you want to delete from the list. After the confirmation screen is displayed, select **Yes** to delete the recipient from the group e-mail.

3. To add another member, select **Add member** again.

The address book is displayed.

4. Select recipient to register as group member.

The member to register is displayed on the list.



Repeat the procedure to register another member to the same group e-mail.

11. Select **Complete** to finalize registration.

»» Note

- To register another group, select an unregistered ID number and operate in the same procedure.

Changing Registered Information

To change information registered for recipient and group e-mail, follow the procedure below.

1. Select  **Others** on the HOME screen.

➔ [Home Screen Menu Composition](#)

2. Select  **Scan**.

3. Select  **Attach to email**.

4. Select  **E-mail directly from device**.

5. Select **Edit e-mail address book**.

6. Select **Display e-mail address book**.

7. Select recipient or group e-mail to change.

8. Change registered information.

- To change an individual recipient:

1. Select **Edit e-mail address**.

The registered information screen of the selected recipient is displayed.

2. Select entry field of name or entry field of e-mail addresses.

The each edit screen is displayed.

3. Change name or e-mail addresses.

4. Select **OK**.

The touch screen returns to the registered information screen.

5. Select **Register**.

- To change a group e-mail:

1. Select **Edit group e-mail**.

The registered information screen of the group e-mail is displayed.

2. To change group name, select entry field of name.

When edit screen of group name is displayed, change the group name then select **OK**.

3. To add member, select **Add member**.

When the e-mail address book is displayed, select the recipient you want to add.





4. To delete member, select recipient on list.

When the confirmation screen is displayed, select **Yes** to delete the recipient from the group e-mail.

5. Select **Complete** to finalize changing.

Deleting Registered Information

To delete information registered for recipient and group e-mail, follow the procedure below.

1. Select  **Others** on the HOME screen.
➔ [Home Screen Menu Composition](#)
2. Select  **Scan**.
3. Select  **Attach to email**.
4. Select  **E-mail directly from device**.
5. Select **Edit e-mail address book**.
6. Select **Display e-mail address book**.
7. Select recipient or group e-mail to delete.
8. Select **Delete e-mail address** or **Delete group e-mail**.
9. When confirmation screen is displayed, select **Yes** to delete.

Importing/Exporting E-Mail Address Book

You can import an e-mail address book saved on a USB flash drive, or export the e-mail address book saved on the printer to a USB flash drive.

- ➔ [Importing E-Mail Address Book](#)
- ➔ [Exporting E-Mail Address Book](#)

Importing E-Mail Address Book

Follow the procedure below to import the e-mail address book.

1. Insert USB flash drive into USB flash drive port.

2. Select  **Others** on the HOME screen.

➔ [Home Screen Menu Composition](#)

3. Select  **Scan**.

4. Select  **Attach to email**.

5. Select  **E-mail directly from device**.

6. Select **Edit e-mail address book**.

7. Select **Import e-mail address book**.

8. Check message that is displayed and select **Yes**.

The address book saved on the USB flash drive is imported and the address book on the printer is overwritten. (The address book name is "EMAIL_ADDRESS.BIN").

Exporting E-Mail Address Book

Follow the procedure below to export the e-mail address book.

1. Insert USB flash drive into USB flash drive port.

➤➤➤ Note

- To avoid overwriting the e-mail address book, you cannot save the book on a USB flash drive which already includes it.

Delete the book from the USB flash drive or use the one which includes no book.

- The address book is stored in "CANON_SCEMAIL_ADDRESS.BIN".

2. Select  **Others** on the HOME screen.

➔ [Home Screen Menu Composition](#)

3. Select  **Scan**

4. Select  **Attach to email.**

5. Select  **E-mail directly from device.**

6. Select **Edit e-mail address book.**

7. Select **Export e-mail address book.**

8. Check message that is displayed and select **Yes.**

The address book on the printer is saved on the USB flash drive.

Sending Scanned Data as E-Mail from Computer

Before attaching scanned data to an e-mail, check the following:

- **Printer driver is installed. (Windows)**

If the printer driver is not installed yet, install the printer driver from the Setup CD-ROM or the Canon website.

➔ [Installing the Printer Driver](#)

- **When scanning via a network connection**

Make sure the printer is connected to the computer correctly.

- For Windows:

➔ [Network Scan Settings](#)

- For macOS:

➔ Scan-from-Operation-Panel Settings Screen

Follow the procedure below to send the scanned data as an e-mail from the computer.

1. Loading Originals on Document Platen.

➔ [Loading Originals on Document Platen](#)

2. Select  **Others** on the HOME screen.

➔ [Home Screen Menu Composition](#)

3. Select  **Scan**.

4. Select  **Attach to email**.

5. Select  **E-mail from PC**.

6. Select a computer to save scanned data.

Select **Local (USB)** for a USB-connected computer, or select the computer to save the scanned data for a network-connected computer.



The Scan standby screen is displayed.

7. Specify settings as necessary.

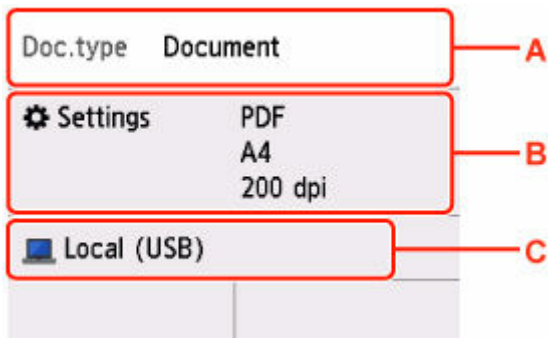

A: Select the document type.

Document

Select to scan the document.

Photo

Select to scan the photo.

B: Displays **Scan settings** screen.

For more on the setting items:

➔ [Setting Items for Scanning Using Operation Panel](#)

C: Displays the screen to select the save.

8. Press the **Black** button or the **Color** button.

▶▶▶ **Note**

- If the original is not loaded properly, a message is displayed on the touch screen. Load the original on the platen according to the scan settings.
- When you select **JPEG** for **Format** on the scan setting screen:
The printer starts scanning and scanned data is saved to the computer and attached to an e-mail.
- When you select **PDF** or **Compact PDF** for **Format** on the scan setting screen:
The confirmation screen asking you if you continue scanning is displayed after scanning is complete.



If you continue scanning, load the original on the platen and start scanning.

If you do not continue scanning, select **End**. The scanned data is saved to the computer in one PDF file and attached to an e-mail.

9. Send e-mail from your computer.

▶▶▶ Note

- You can specify the email software used to send attachments from Canon IJ Scan Utility and Canon IJ Scan Utility Lite. For more on settings of Canon IJ Scan Utility/Canon IJ Scan Utility Lite:
 - For Windows:
 - ➔ [Settings Dialog Box](#)
 - For macOS:
 - ➔ Settings Dialog
- When using Windows, the program selection screen may be displayed after pressing **Black** button or **Color** button.

In this case, select **Canon IJ Scan Utility** and click **OK**.
- Canon IJ Scan Utility (Windows) or Canon IJ Scan Utility Lite (macOS) allows you to specify how to respond when scanning from the operation panel. For more on settings of Canon IJ Scan Utility/Canon IJ Scan Utility Lite:
 - For Windows:
 - ➔ [Setting Up Operation Panel with IJ Scan Utility \(Windows\)](#)
 - For macOS:
 - ➔ [Setting Up Operation Panel with IJ Scan Utility Lite \(macOS\)](#)

Saving Scanned Data on USB Flash Drive

You can save the scanned data directly to a USB flash drive. You can also delete the saved scanned data.

➔ [Saving Scanned Data on USB Flash Drive](#)

➔ [Deleting Scanned Data on USB Flash Drive](#)

»» Important

- Do not remove the USB flash drive from the printer under the following conditions:
 - While scanning is in progress
 - Before saving the scanned data
- For safety reasons, we recommend backing up the scanned data saved on a USB flash drive to another media periodically to avoid unexpected accidents.
- We assume no responsibility for damage to or loss of data for whatever reason even within the warranty period.

Saving Scanned Data on USB Flash Drive

1. Loading Originals on Document Platen.

➔ [Loading Originals on Document Platen](#)

2. Insert USB flash drive into USB flash drive port.

3. Select  **Others** on the HOME screen.

➔ [Home Screen Menu Composition](#)

4. Select  **Scan**.

5. Select  **Save to USB flash drive**

6. Select **Save to USB flash drive**

7. Specify settings as necessary.

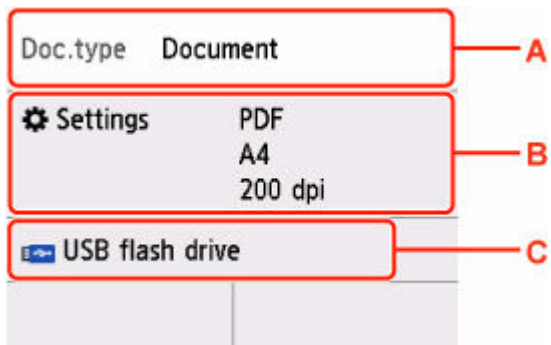

A: Select the document type.

Document

Select to scan the document.

Photo

Select to scan the photo.

B: Displays **Scan settings** screen.

For more on the setting items:

➔ [Setting Items for Scanning Using Operation Panel](#)

C: Displays the screen to select the save.

8. Press the **Black button or the **Color** button.**

➤➤➤ Note

- If the original is not loaded properly, a message is displayed on the touch screen. Load the original on the platen according to the scan settings.

- If you select **ON** for **Preview** on the scan setting screen:

The preview screen is displayed before saving the scanned original on the USB flash drive.

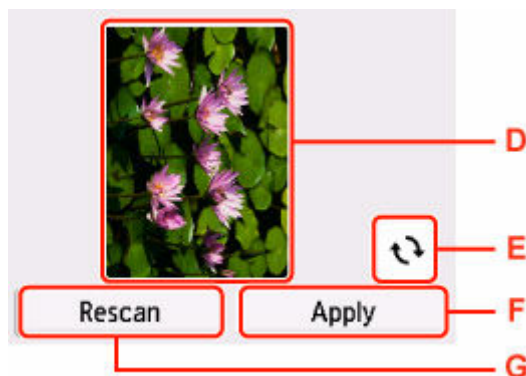

E: The preview screen of the scanning data is displayed.

F: Select to rotate the preview screen.

Displayed when you select **PDF** or **Compact PDF** for **Format** on the scan setting screen.

G: Select to save the scanned original on the USB flash drive.

H: Select to rescan the original.

- When you select **JPEG** for **Format** on the scan setting screen:

The printer starts scanning and scanned data is saved on the USB flash drive.

- When you select **PDF** or **Compact PDF** for **Format** on the scan settings screen:

The confirmation screen asking you if you continue scanning is displayed after scanning is complete.



If you continue scanning, load the original on the platen and start scanning.

If you do not continue scanning, select **End**. The scanned data is saved on the USB flash drive in one PDF file.

When you scan the originals continuously, you can save up to 100 pages of images in one PDF file.

▶▶▶ Note

- If the USB flash drive becomes full while scanning images is in progress, only the images already scanned can be saved.
- You can save up to 2000 files of scanned data saved on the USB flash drive in both PDF and JPEG data format.
- The folder and file name of scanned data saved on the USB flash drive is as follows:
 - Folder name: (file extension: PDF): CANON_SC\DOCUMENT\0001
 - Folder name: (file extension: JPG): CANON_SC\IMAGE\0001
 - File name: Running numbers, starting from SCN_0001
 - File date: The date and time of saving as set in the printer.

For details on how to set the date and time:

➔ [Other printer settings](#)

- You can import the scanned data saved on a USB flash drive to the computer. After scanning the data, connect the USB flash drive to the computer and import the data.

Deleting Scanned Data on USB Flash Drive

With the USB flash drive loaded in the USB flash drive port, select **Others > Scan > Save to USB flash drive > Delete saved data** from the printer's operation panel. Select the file you want to delete from the list of files displayed, and select **Yes** on the confirmation screen to delete the file.

Forwarding Scanned Data to Shared Folder on Computer

Before forwarding scanned data to the shared folder on computer, check the following:

- **Printer driver and Canon Quick Utility Toolbox are installed. (Windows)**

If the printer driver is not installed yet, install the printer driver from the Setup CD-ROM or the Canon website.

➔ [Installing the Printer Driver](#)

Install Canon Quick Utility Toolbox if it is not yet installed.

➔ Downloading Quick Utility Toolbox

- **The Canon Quick Utility Toolbox is installed. (macOS)**

Install Canon Quick Utility Toolbox if it is not yet installed.

➔ Downloading Quick Utility Toolbox

- **The printer is connected to a computer via a LAN correctly.**

- For Windows:

➔ [Network Scan Settings](#)

- For macOS:

➔ Scan-from-Operation-Panel Settings Screen

Follow the procedure below to forward scanned data to the shared folder on the computer.

1. Setting the Destination

You can register the destination folder using Canon Quick Utility Toolbox. For more on settings of Canon Quick Utility Toolbox:

- For Windows:

➔ Destination Folder Settings(Windows)

- For Mac OS:

➔ Destination Folder Settings(macOS)

2. Loading Originals on Document Platen.

➔ [Loading Originals on Document Platen](#)



3. Select **Others** on the HOME screen.

➔ [Home Screen Menu Composition](#)



4. Select **Scan**.



5. Select **Save to destination folder**.

6. Select the folder to save scanned data on the **Select folder** screen.

»»» **Note**

- When you specify a PIN code for a registered folder, a screen asking you to enter a PIN code is displayed. Entering the PIN code allows you to assign the shared folder as the destination.

7. Specify settings as necessary.

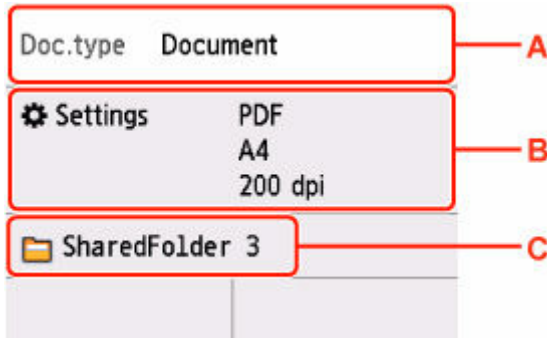

A: Select the document type.

Document

Select to scan the document.

Photo

Select to scan the photo.

B: Displays **Scan settings** screen.

For more on the setting items:

- ➔ [Setting Items for Scanning Using Operation Panel](#)

C: Displays the screen to select the save/forward.

8. Press the **Black** button or the **Color** button.

»»» **Note**

- If the original is not loaded properly, a message is displayed on the touch screen. Load the original on the platen according to the scan settings.

- If you select **ON** for **Preview** on the scan setting screen:

The preview screen is displayed before forwarding scanned data to shared folder on computer.

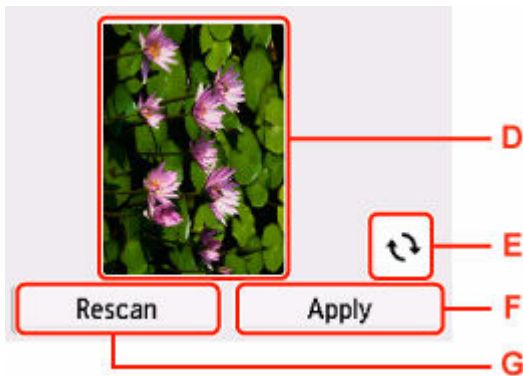

D: The preview screen of the scanning data is displayed.

E: Select to rotate the preview screen.

Displayed when you select **PDF** or **Compact PDF** for **Format** on the scan setting screen.

F: Select to forward the scanned original to the shared folder on the computer.

G: Select to rescan the original.

- When you select **JPEG** for **Format** on the scan setting screen:

The printer starts scanning and scanned data is forwarded to the shared folder of the computer.

- When you select **PDF** or **Compact PDF** for **Format** on the scan setting screen:

The confirmation screen asking you if you continue scanning is displayed after scanning is complete.



If you continue scanning, load the original on the platen and start scanning.

If you do not continue scanning, select **End**. The scanned data is forwarded to the computer in one PDF file.

Scanned data is forwarded to the computer according to the settings specified in Canon Quick Utility Toolbox.

Scanning with a Computer Application

- Scanning with Windows
- Scanning with macOS

Scanning in Windows

► Scanning According to Item Type or Purpose (IJ Scan Utility)

- IJ Scan Utility Features
- Scanning Documents and Photos
- Creating/Editing PDF Files
 - Setting Passwords for PDF Files
 - Editing Password-Protected PDF Files
- Scanning with Favorite Settings
- Scanning Originals Larger than the Platen (Image Stitch)
 - Adjusting Cropping Frames in the **Image Stitch** Window
- Scanning Multiple Originals at One Time
- Extracting Text from Scanned Images (OCR)
- Sending Scanned Images via E-mail
- Saving after Checking Scan Results
- Starting IJ Scan Utility
- IJ Scan Utility Screens

► Scanning Using Application Software (ScanGear)

► Scanning Tips

- Positioning Originals (Scanning from Computer)
- Network Scan Settings
 - IJ Network Scanner Selector EX2 Menu and Setting Screen
- Scanning with WIA Driver
- Resolution
- Data Formats
- Color Matching

»» Important

- Available functions and settings vary depending on your scanner or printer.

Scanning According to Item Type or Purpose (IJ Scan Utility)

- ▶ **IJ Scan Utility Features**
- ▶ **Scanning Documents and Photos**
- ▶ **Creating/Editing PDF Files**
 - Setting Passwords for PDF Files
 - Editing Password-Protected PDF Files
- ▶ **Scanning with Favorite Settings**
- ▶ **Scanning Originals Larger than the Platen (Image Stitch)**
 - Adjusting Cropping Frames in the **Image Stitch** Window
- ▶ **Scanning Multiple Originals at One Time**
- ▶ **Sending Scanned Images via E-mail**
- ▶ **Extracting Text from Scanned Images (OCR)**
- ▶ **Saving after Checking Scan Results**
- ▶ **Starting IJ Scan Utility**
- ▶ **IJ Scan Utility Screens**

▶▶▶ Important

- Available functions and settings vary depending on your scanner or printer.

IJ Scan Utility Features

Use IJ Scan Utility to scan and save documents, photos, or other items at one time by simply clicking the corresponding icon.

»» Important

- Available functions, the displayed items, and available settings vary depending on your model.

Multiple Scanning Modes

Auto allows for one click scanning with default settings for various items. **Document** will sharpen text in a document or magazine for better readability, and **Photo** is best suited for scanning photos.

»» Note

- For details on the IJ Scan Utility main screen, see [IJ Scan Utility Main Screen](#).

Save Scanned Images Automatically

Scanned images are automatically saved to a preset folder. The folder can be changed as needed.

»» Note

- The default save folders are as follows.
 - **Windows 11/Windows 10/Windows 8.1:**
Documents folder
 - **Windows 7:**
My Documents folder
- To change folder, see [Settings Dialog Box](#).

Application Integration

Scanned images can be sent to other applications. For example, display scanned images in your favorite graphics application, attach them to e-mails, or extract text from images.

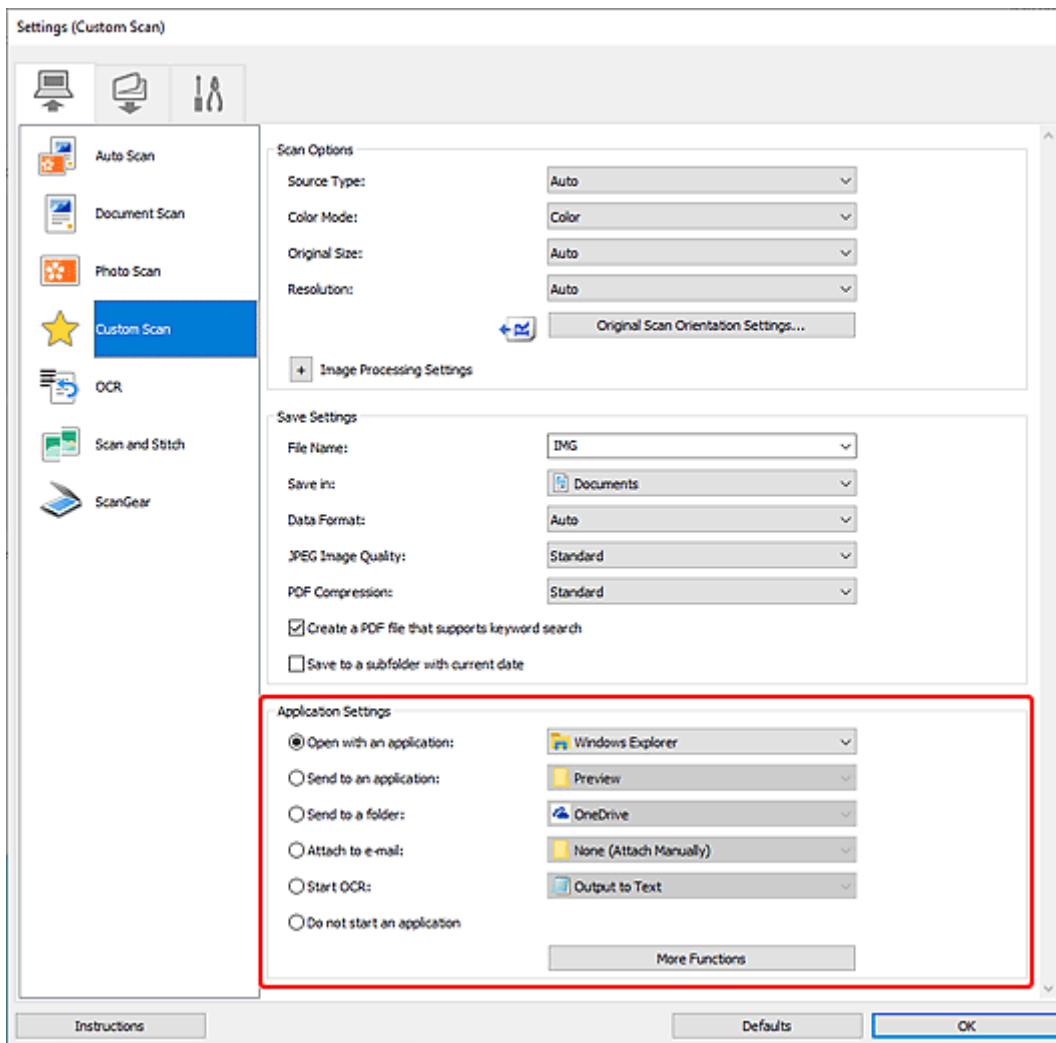

►►► Note

- To set the applications to integrate with, see [Settings Dialog Box](#).

Scanning Documents and Photos

Scan items placed on the platen with settings suitable for documents or photos.

Save documents in formats such as PDF and JPEG, and photos in formats such as JPEG and TIFF.

1. Place the item on the platen.

➔ [Positioning Originals \(Scanning from Computer\)](#)

2. [Start IJ Scan Utility.](#)

3. To specify the paper size, resolution, PDF settings, etc., click  **Settings...**, and then set each item in the [Settings \(Scanning from a Computer\) dialog box](#).

▶▶▶ Note

- Once settings are made in the Settings dialog box, the same settings can be used for scanning from the next time.
- In the Settings dialog box, specify image processing settings such as slant correction and outline emphasis, set the destination of the scanned images, and more, as needed.

When setting is completed, click **OK**.

4. Click  **Document** or  **Photo** in the [IJ Scan Utility main screen](#).

Scanning starts.

▶▶▶ Note

- To cancel the scan, click **Cancel**.

Creating/Editing PDF Files

You can create PDF files by scanning items placed on the platen or ADF (Auto Document Feeder). Add, delete, rearrange pages or make other edits in the created PDF files.

▶▶▶ Important

- You can create or edit up to 100 pages of a PDF file at one time.
- Only PDF files created or edited in IJ Scan Utility or IJ PDF Editor are supported. PDF files created or edited in other applications are not supported.

▶▶▶ Note

- You can also create PDF files from images saved on a computer.
- Selectable file formats are PDF, JPEG, TIFF, and PNG.
- Images whose number of pixels in the vertical or horizontal direction is 10501 or more cannot be used.
- When you select a password-protected PDF file, you must enter the password.

➔ [Editing Password-Protected PDF Files](#)

1. Place items on platen or ADF.

2. [Start IJ Scan Utility.](#)

3. Click  **PDF Editor** in the [IJ Scan Utility main screen](#).

IJ PDF Editor starts.

4. To specify the paper size, resolution, and other settings, click **Settings...** from the **File** menu, and then set each item in the [Settings \(Scanning from a Computer\) dialog box](#).

▶▶▶ Note

- Once settings are made in the Settings dialog box, the same settings can be used for scanning from the next time.
- In the Settings dialog box, specify image processing settings such as slant correction and outline emphasis.

When setting is completed, click **OK**.

5. Click  (Scan) on Toolbar.

Scanning starts.

▶▶▶ Note

- To open a file saved on the computer, click **Open...** from the **File** menu, and then select the file you want to edit.
- You can switch the view with the Toolbar buttons. For details, see [PDF Edit Screen](#).

6. Add pages as needed.

When scanning and adding more items:

Place items, and then click  (Scan) on the Toolbar.

When adding existing images or PDF files:



Click  (Add Page) on the Toolbar. After the **Open** dialog box appears, select the image(s) or PDF file(s) you want to add, and then click **Open**.

»»» Note

- You can also add images or PDF files from **Add Page from Saved Data...** in the **File** menu.

7. Edit pages as needed.

When changing page order:

Click the page you want to move, and then click  (Page Up) or  (Page Down) on the Toolbar to change the page order. You can also change the page order by dragging and dropping a page to the target location.

When deleting pages:

Click the page you want to delete, and then click  (Delete Page) on the Toolbar.

»»» Note

- These buttons appear when two or more pages have been created.

8. Select **Save As...** in **File** menu.

The **Save** dialog box appears.

9. Specify save settings.

»»» Important

- The following items cannot be set for images whose resolution is outside the range of 75 dpi to 600 dpi or whose number of pixels in the vertical or horizontal direction is between 10201 pixels and 10500 pixels.
 - **PDF Compression**
 - **Create a PDF file that supports keyword search**
 - **Correct slanted text originals**
 - **Detect the orientation of text original and rotate image**

File Name

Enter a file name for the PDF file to be saved. When two or more pages have been created and you are saving each page separately, a sequential number is appended to the file names.

Save in

Set the folder in which to save PDF files. To change the folder, click **Browse...**, and then specify the destination folder.

Save to a subfolder with current date

Select this checkbox to create a current date folder in the folder specified in **Save in** and save created or edited PDF files in it. The folder will be created with a name such as "20XX_01_01" (Year_Month_Date).

If this checkbox is not selected, files are saved directly in the folder specified in **Save in**.

File Type

Select the file format for saving PDF files.

PDF

Save each page as a separate PDF file.

PDF (Multiple Pages)

Save multiple pages in one PDF file.

▶▶▶ Note

- **PDF (Multiple Pages)** appears when two or more pages have been created.

PDF Compression

Select the compression type for saving.

Standard

It is recommended that you normally select this setting.

High

Compresses the file size when saving. This will reduce the load on your network and server.

▶▶▶ Important

- If you save PDF files with high compression repeatedly, images may degrade.

Create a PDF file that supports keyword search

Select this checkbox to convert text in images into text data and create PDF files that support keyword search.

Correct slanted text originals

Select this checkbox to detect the document orientation based on the text in images and correct the angle (within the range of -0.1 to -10 degrees or +0.1 to +10 degrees) for creating PDF files.

▶▶▶ Important

- The following types of image may not be corrected properly since the text cannot be detected correctly.
 - Images in which the text lines are inclined more than 10 degrees or the angles vary by line
 - Images containing both vertical and horizontal text
 - Images with extremely large or small fonts
 - Images with small amount of text
 - Images containing figures/images
 - Hand-written images

Detect the orientation of text original and rotate image

Select this checkbox to detect the page orientation based on the text in images and automatically rotate the images to the correct orientation for creating PDF files.

»» Important

- This function is available only for images (text documents) containing languages that can be selected from **Document Language** in the **Settings (General Settings)** dialog box of IJ Scan Utility. This function is not available depending on the language in the image.
- The page orientation of the following types of image may not be detected since the text cannot be detected correctly.
 - Images with small amount of text
 - Images containing text whose font size is outside the range of 8 points to 48 points
 - Images containing special fonts, effects, italics, or hand-written text
 - Images with patterned backgrounds

Set up password security

Select this checkbox to display the **Password Security Settings** dialog box for setting a password for opening the created PDF file or a password for printing/editing it.

»» Important

- When a password-protected PDF file is edited, the passwords will be deleted. Reset the passwords.
 - ➔ [Setting Passwords for PDF Files](#)

10. Click **Save**.

The PDF file is saved.

»» Note

- When a password-protected PDF file is edited, the passwords will be deleted. Reset the passwords in the **Save** dialog box.
 - ➔ [Setting Passwords for PDF Files](#)
- To overwrite a saved file, click  (Save) on the Toolbar.

Setting Passwords for PDF Files

Set passwords for PDF files you create in IJ Scan Utility to restrict opening, editing, and printing of the files.

The following two types of password can be set.

- Password for opening the PDF file
- Permissions password for printing or editing the PDF file

»» Important

- You will not be able to open or edit the PDF file if you forget the password. It is recommended that you write down the passwords and keep them in a safe place for future reference.
- Password-protected PDF files cannot be opened in applications that do not support security settings for PDF files.
- Even if a permissions password is set for a PDF file, the restricted commands (print, edit, etc.) may differ from those in IJ Scan Utility depending on your application.

»» Note

- Setting passwords from the PDF edit screen is used as an example in the following descriptions.

1. [Start IJ Scan Utility.](#)

2. Click **PDF Editor** in the [IJ Scan Utility main screen](#).

IJ PDF Editor starts.

3. Open the PDF file for which you want to set password.

4. Select **Save As...** in **File** menu.

The **Save** dialog box appears.

5. Select **Set up password security** checkbox.

The **Password Security Settings** dialog box appears.

6. Select **Require a password to open the document** or **Require a password to print or edit the document** checkbox, and then enter the password you want to set.

»» Important

- Enter a password of up to 32 characters using single-byte letters, numbers, and/or symbols (!"# \$ %&'()*+,-./:;<=>?@[^_`{|}~). Passwords are case sensitive.

»» Note

- To set both **Document Open Password** and **Permissions Password**, select both checkboxes and specify a different password for each.
In each **Password (Confirmation)**, enter the corresponding password you have set.

7. Click **OK**.

Click **OK** to set the password(s) and return to the **Save** dialog box (PDF edit screen).

8. Click **Save**.

The PDF file is saved.

»» Important

- Even if you set password(s) and save the PDF file, the password(s) will be deleted once you edit the file.
To reset the password(s) and save the file, select **Save As...** from the **File** menu, and then reset the password(s).

»» Note

- To overwrite a saved file, click  (Save) on the Toolbar.

Editing Password-Protected PDF Files

When editing a password-protected PDF file, you must enter the password.

►► Important

- Only PDF files whose password was set in IJ Scan Utility can be edited. PDF files edited in other applications or whose password was set in other applications cannot be edited.
- Passwords are case sensitive.
- You can create or edit up to 100 pages of a PDF file at one time.

1. [Start IJ Scan Utility.](#)

2. Click **PDF Editor** in the [IJ Scan Utility main screen](#).

IJ PDF Editor starts.

3. Select **Open...** in **File** menu.

4. Select password-protected PDF file.

The **Password** dialog box appears.

5. Enter **Permissions Password**, and then click **OK**.

If only **Document Open Password** is set, enter **Document Open Password**.

The PDF file opens; edit as needed.

►► Note

- If both **Document Open Password** and **Permissions Password** are set, enter only **Permissions Password** to open the file.
- The displayed dialog box varies depending on the type of the set password.
- If multiple files are selected, check the file name displayed in the dialog box, and then enter the corresponding password.

►► Important

- When a password-protected PDF file is edited, the passwords will be deleted. Reset the passwords in the **Password Security Settings** dialog box.

➔ [Setting Passwords for PDF Files](#)

Scanning with Favorite Settings

You can scan items placed on the platen with your favorite settings saved beforehand.

This is convenient for saving frequently used settings or when specifying scan settings in detail.

1. Place the item on the platen.

➔ [Positioning Originals \(Scanning from Computer\)](#)

2. [Start IJ Scan Utility](#).

3. To specify the paper size, resolution, PDF settings, etc., click  **Settings...**, and then set each item in the [Settings \(Scanning from a Computer\) dialog box](#).

▶▶▶ Note

- Once settings are made in the Settings dialog box, the same settings can be used for scanning from the next time.
- In the Settings dialog box, specify image processing settings such as slant correction and outline emphasis, set the destination of the scanned images, and more, as needed.

When setting is completed, click **OK**.

4. Click  **Custom** in the [IJ Scan Utility main screen](#).

Scanning starts.

▶▶▶ Note

- To cancel the scan, click **Cancel**.

Scanning Originals Larger than the Platen (Image Stitch)

You can scan the left and right halves of an item larger than the platen and combine them back into one image. Items up to approximately twice as large as the platen are supported.

▶▶▶ Note

- The following explains how to scan from the item to be placed on the left side.

1. [Start IJ Scan Utility](#).

- #### 2. To specify the item type, resolution, and PDF settings, click **Settings...**, and then set each item in the [Settings \(Scanning from a Computer\) dialog box](#).

▶▶▶ Note

- Once settings are made in the **Settings (Scan and Stitch)** dialog box, the same settings can be used for scanning from the next time.
- In the **Settings (Scan and Stitch)** dialog box, set image processing settings such as show-through reduction and moire pattern reduction, set where to save the scanned images, and more, as needed.

When setting is completed, click **OK**.

- #### 3. Click **Stitch** in the [IJ Scan Utility main screen](#).

The **Image Stitch** window appears.

- #### 4. In **Select Output Size**, select an output size according to the paper size.

Select Output Size

B4 (B5 x 2)

Scans the left and right halves of a B4 size item separately.

A3 (A4 x 2)

Scans the left and right halves of an A3 size item separately.

11 x 17 (Letter x 2)

Scans the left and right halves of an item twice as large as Letter size separately.

Full Platen x 2

Scans the left and right halves of an item twice as large as the platen separately.

▶▶▶ Note

- The displayed items vary depending on the select source and view.

- #### 5. Make sure that **Scan from Left** is selected in **Scan Direction**.

- #### 6. Place the item's side that is to be displayed on the left side of the screen (1) face-down on the platen.

Align the upper corner of the item with the corner at the arrow (alignment mark) of the platen.

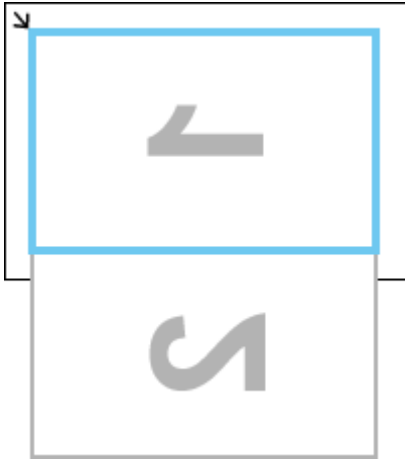

7. Click Start Scanning Image 1.

The first item is scanned and appears in 1.

▶▶▶ Note

- To cancel the scan, click **Cancel**.

8. Rotate the item 180 degrees, and then align the lower corner of the side that is to be displayed on the right side of the screen (2) with the corner at the arrow (alignment mark) of the platen.

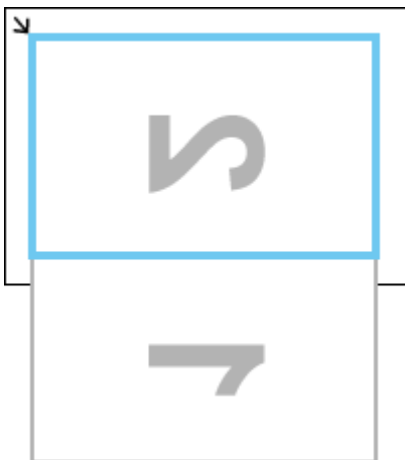





9. Click Start Scanning Image 2.

The second item is scanned and appears in 2.

▶▶▶ Note

- To cancel the scan, click **Cancel**.

10. Adjust the scanned images as required.

Use the     (Toolbar) to rotate or zoom in/out, or drag the images to adjust their positions.

▶▶▶ Note

- Select the **Adjust cropping frames** checkbox to specify the area to be saved.
 - ➔ [Adjusting Cropping Frames in the Image Stitch Window](#)
- To scan an item again, select the image in the Preview area or the thumbnail at the top of the screen, then click  (Delete). The selected image is deleted, allowing you to scan the item again.

11. Click **Save**.

The combined image is saved.

Adjusting Cropping Frames in the Image Stitch Window

"Cropping" is the act of selecting the area you want to keep in an image and discarding the rest when scanning it.

In the **Image Stitch** window, you can specify a cropping frame on the image displayed in the Preview area.

▶▶▶ Note

- Refer to "[Adjusting Cropping Frames \(ScanGear\)](#)" for how to adjust cropping frames with ScanGear (scanner driver).

Initial Cropping Frame

No cropping frame is specified. When you select the **Adjust cropping frames** checkbox, an active cropping frame is automatically specified around the image in the Preview area. You can drag the cropping frame to specify the area.

When you perform a scan, the image in the area specified with the cropping frame will be scanned.

Adjusting a Cropping Frame

The cursor will change into  (Arrow) when it is positioned over a cropping frame. Click and drag the mouse to expand or contract the cropping frame.



The cursor will change into  (Crosshair Arrow) when it is positioned within a cropping frame. Click and drag the mouse to move the entire cropping frame.



Deleting Cropping Frames

To delete the cropping frame, deselect the **Adjust cropping frames** checkbox.

Scanning Multiple Originals at One Time

You can scan two or more photos (small items) placed on the platen at one time and save each image individually.

▶▶▶ Important

- The following types of items may not be scanned correctly. In that case, adjust the cropping frames (scan areas) in whole image view of ScanGear (scanner driver), and then scan again.
 - Photos with a whitish background
 - Items printed on white paper, hand-written text, business cards, and other unclear items
 - Thin items
 - Thick items
- Refer to "[Scanning Multiple Documents at One Time with ScanGear \(Scanner Driver\)](#)" for details.
- **Auto** does not appear depending on your model.

In the Settings dialog box, set **Original Size** to **Auto scan** and scan.

▶▶▶ Note

- The screens for scanning with favorite settings are used as examples in the following descriptions.

1. Place the item on the platen.

➔ [Positioning Originals \(Scanning from Computer\)](#)

2. [Start IJ Scan Utility.](#)

3. Click  **Settings...**

The Settings dialog box appears.

4. Click  **Custom Scan** in the [Settings \(Scanning from a Computer\) Dialog Box](#).

5. Select **Source Type** according to the items to be scanned.

6. Select **Auto scan** for **Original Size**, then click **OK**.

The IJ Scan Utility main screen appears.

▶▶▶ Note

- Once settings are made in the Settings dialog box, the same settings can be used for scanning from the next time.
- In the Settings dialog box, specify image processing settings such as slant correction, set where to save the scanned images, and more, as needed.

7. Click  **Custom** in the [IJ Scan Utility main screen](#).

Multiple items are scanned at one time.

▶▶ Note

- To cancel the scan, click **Cancel**.

Sending Scanned Images via E-mail

You can send scanned images via e-mail easily by simply clicking **E-mail** in the IJ Scan Utility main screen.

▶▶▶ Important

- **E-mail** does not appear depending on your model. If it does not appear, see [If There Is No Icon for E-Mail Scan](#).

▶▶▶ Note

- You can also send scanned images via e-mail from **Document**, **Photo**, **Custom**, or **ScanGear**.

1. Place the Item on the Platen

- ➔ [Positioning Originals \(Scanning from Computer\)](#)

2. [Start IJ Scan Utility](#).

3. Click  **Settings...**, then set the item type, resolution, etc. in the [Settings \(Scanning from a Computer\) dialog box](#), and then select an e-mail client.

When setting is completed, click **OK**.

4. Click  **E-mail** in the [IJ Scan Utility main screen](#).

Scanning starts.

When scanning is completed, the specified e-mail client starts and the images will be attached to a new message.

▶▶▶ Note

- To cancel the scan, click **Cancel**.
- The scanned images are saved according to the settings made in the Settings dialog box.
- If the **Check scan results and specify save settings** checkbox is selected in the Settings dialog box, the **Save Settings** dialog box appears. After you set the save options and click **OK**, the scanned images are saved and automatically attached to a new message of the specified e-mail client. For how to check the scan results before saving them, see [Saving after Checking Scan Results](#).

5. Specify the recipient, enter the subject and message, then send e-mail.

Refer to the manual of your e-mail client for e-mail settings.

If There Is No Icon for E-Mail Scan

▶▶▶ Note

- The screens for scanning photos are used as examples in the following descriptions.

1. [Start IJ Scan Utility.](#)

2. Click  **Settings...**

The [Settings dialog box](#) appears.

3. Click  **Photo Scan** in the [Settings \(Scanning from a Computer\) Dialog Box.](#)

4. Select **Attach to e-mail** in **Application Settings**, then select an e-mail client.

▶▶▶ **Note**

- You can add e-mail clients to use for attachments from the pull-down menu.
- If **None (Attach Manually)** is selected, manually attach scanned and saved images to e-mail.

5. Click **OK**.

The IJ Scan Utility main screen appears.

▶▶▶ **Note**

- For the setting items in the Settings dialog box, see [Settings \(Scanning from a Computer\) dialog box.](#)

6. Click  **Photo** in the [IJ Scan Utility main screen.](#)

Scanning starts.

When scanning is completed, the specified e-mail client starts and the images will be attached to a new message.

▶▶▶ **Note**

- To cancel the scan, click **Cancel**.
- The scanned images are saved according to the settings made in the Settings dialog box.
- If the **Check scan results and specify save settings** checkbox is selected in the Settings dialog box, the **Save Settings** dialog box appears. After you set the save options and click **OK**, the scanned images are saved and automatically attached to a new message of the specified e-mail client. For how to check the scan results before saving them, see [Saving after Checking Scan Results.](#)

7. Specify the recipient, enter the subject and message, then send e-mail.

Refer to the manual of your e-mail client for e-mail settings.

Extracting Text from Scanned Images (OCR)

Click **OCR** in the IJ Scan Utility main screen to scan text in scanned magazines and newspapers and display it in a specified application.

▶▶▶ Note

- You can also extract text from **Document**, **Custom**, or **ScanGear**.

1. Place the Item on the Platen

- ➔ [Positioning Originals \(Scanning from Computer\)](#)

2. [Start IJ Scan Utility.](#)

3. Click  **Settings...**, then set the document type, resolution, etc. in the [Settings \(Scanning from a Computer\) dialog box](#), and then select the application in which you want to display the result.

When setting is completed, click **OK**.

▶▶▶ Note

- For **Resolution**, only **300 dpi** or **400 dpi** can be set.
- If a compatible application is not installed, the text in the image is extracted and appears in your text editor.
Text to be displayed is based on **Document Language** in the [Settings \(General Settings\) dialog box](#). Select the language you want to extract in **Document Language** and scan.
- You can add the application from the pull-down menu.

4. Click  **OCR** in the [IJ Scan Utility main screen](#).

Scanning starts.

When scanning is completed, the scanned images are saved according to the settings, and the extracted text appears in the specified application.

▶▶▶ Note

- To cancel the scan, click **Cancel**.
- Text displayed in your text editor is for guidance only. Text in the image of the following types of documents may not be detected correctly.
 - Documents containing text with font size outside the range of 8 points to 40 points (at 300 dpi)
 - Slanted documents
 - Documents placed upside down or documents with text in the wrong orientation (rotated characters)
 - Documents containing special fonts, effects, italics, or hand-written text
 - Documents with narrow line spacing
 - Documents with colors in the background of text

– Documents containing multiple languages

Saving after Checking Scan Results

You can check the scan results, then save the images to a computer.

»» Important

- In the following cases, you cannot check the scan results in the **Save Settings** dialog box before saving them.
 - When scanned with **Auto** scan
 - When scanned from the operation panel or scanner buttons
 - When scanned by selecting **Canon IJ PDF Editor** for **Open with an application** in **Application Settings**
- Available functions, the displayed items, and available settings vary depending on your model.

»» Note

- Photo scanning is used as an example in the following descriptions.

1. [Start IJ Scan Utility.](#)

2. Click **Settings...**

The [Settings dialog box](#) appears.

3. Click **Photo Scan** in the [Settings \(Scanning from a Computer\) Dialog Box](#).

4. Select **Check scan results and specify save settings** checkbox, and then click **OK**.

The IJ Scan Utility main screen appears.

»» Note

- For the setting items in the Settings dialog box, see [Settings \(Scanning from a Computer\) dialog box](#).

5. Click **Photo** in the [IJ Scan Utility main screen](#).

Scanning starts.

When scanning is completed, the **Save Settings** dialog box appears.

»» Note

- To cancel the scan, click **Cancel**.

6. Change the image order or file save options as required.

You can change the image order or file save options in the **Save Settings** dialog box.



(Delete)

Deletes the image selected in the Scan Results area.



(Rotate Left 90°)/(Rotate Right 90°)

Rotates scanned images 90 degrees counter-clockwise or clockwise.

Select the image you want to rotate, then click  (Rotate Left 90°) or  (Rotate Right 90°).

Important

- The buttons for handling scanned images do not appear when the **Enable large image scans** checkbox is selected in the **Settings (ScanGear)** dialog box.

Scan More

Starts scanning again, and then adds the image to the Scan Results area.

File Name

Enter the file name of the image to be saved. When you save a file, the date and four digits are appended to the set file name in the "_20XX0101_0001" format.

Note

- When you select the **Save to a subfolder with current date** checkbox, the date and four digits are appended to the set file name.

Save in

Displays the folder in which to save the scanned images. To add a folder, select **Add...** from the pull-down menu, then click **Add** in the displayed **Select Destination Folder** dialog box and specify the destination folder.

The default save folders are as follows.

- **Windows 11/Windows 10/Windows 8.1:**
Documents folder
- **Windows 7:**
My Documents folder

Data Format

Select the data format in which to save the scanned images.

You can select **JPEG/Exif**, **TIFF**, **PNG**, **PDF**, or **PDF (Multiple Pages)**.

Important

- You cannot select **PDF** or **PDF (Multiple Pages)** in the following cases.
 - When scanned by clicking **Photo** or **OCR** in the IJ Scan Utility main screen
 - The **Enable large image scans** checkbox is selected in **Save Settings** of the **Settings (ScanGear)** dialog box
 - **Start OCR** is selected in **Application Settings** of the **Settings (Document Scan)**, **Settings (Custom Scan)**, or **Settings (ScanGear)** dialog box
- You cannot select **JPEG/Exif** when **Color Mode** is **Black and White**.

»»» Note

- With network connection, scanning may take longer than usual when you set **TIFF** or **PNG** in **Data Format**.

JPEG Image Quality

You can specify the image quality of JPEG files.

»»» Important

- This appears only when **JPEG/Exif** is selected in **Data Format**.

PDF Compression

Select the compression type for saving PDF files.

Standard

It is recommended that you normally select this setting.

High

Compresses the file size when saving, allowing you to reduce the load on your network/server.

»»» Important

- This appears only when **PDF** or **PDF (Multiple Pages)** is selected in **Data Format**.

Create a PDF file that supports keyword search

Select this checkbox to convert text in images into text data and create PDF files that support keyword search.

»»» Important

- This appears only when **PDF** or **PDF (Multiple Pages)** is selected in **Data Format**.

»»» Note

- PDF files that are searchable in the language selected in **Document Language** on the (General Settings) tab of the Settings dialog box are created.



Save to a subfolder with current date

Select this checkbox to create a current date folder in the folder specified in **Save in** and save scanned images in it. The folder will be created with a name such as "20XX_01_01" (Year_Month_Date).

If this checkbox is not selected, files are saved directly in the folder specified in **Save in**.

Save

Saves the scanned images.

Cancel

Cancels saving.

7. Click **OK**.

Scanned images are saved according to the settings.

Starting IJ Scan Utility

►► Note

- If you have more than one scanner or have changed from USB to network connection, set up the network environment from IJ Scan Utility.

➔ [Network Scan Settings](#)

Follow the steps below to start **IJ Scan Utility**. The following screenshot is from **Windows 11**.

From the Taskbar  (Start button), select **All apps > Canon Utilities > IJ Scan Utility**.

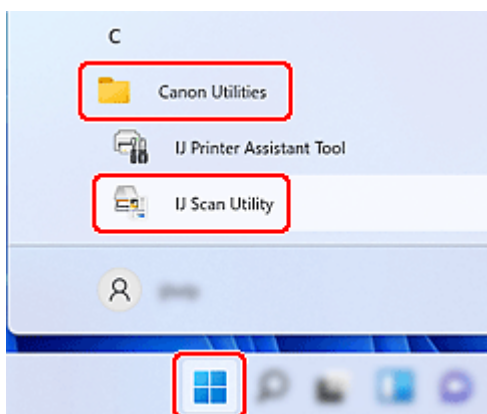

IJ Scan Utility starts.

►► Note

- **Windows 10:**

From the Taskbar  (Start button), select **Canon Utilities > IJ Scan Utility**.

- **Windows 8.1:**

Select **IJ Scan Utility** on the Start screen.

If **IJ Scan Utility** is not displayed on the Start screen, select the **Search** charm, and then search for "IJ Scan Utility".

- **Windows 7:**

From **Start** menu, select **All Programs > Canon Utilities > IJ Scan Utility > IJ Scan Utility**.

IJ Scan Utility Screens

- **IJ Scan Utility Main Screen**
- **Settings Dialog Box**
 - Settings (Scanning from a Computer) Dialog Box
 - Settings (Scanning from the Operation Panel) Dialog Box
 - **Settings (General Settings) Dialog Box**
- **PDF Edit Screen**

IJ Scan Utility Main Screen

You can complete from scanning to saving at one time by simply clicking the corresponding icon.

▶▶▶ Important

- The displayed items vary depending on your model.



Settings...

Displays the [Settings dialog box](#) in which you can specify the scan/save settings and the response after scanning.

Scanner

Displays the name of the product that IJ Scan Utility is currently set to use.

If the displayed product is not the one you want to use, select the desired product from the list.

In addition, for network connection, select one with "Network" after the product name.

▶▶▶ Note

- Refer to "[Network Scan Settings](#)" for how to set up a network environment.



(Help)

Opens this guide.



Auto

Detects the item type automatically and saves them to a computer. The data format for saving will also be set automatically.



Document

Scans items as documents and saves them to a computer.



Doc (Duplex)

Scans both sides of each document at one time and saves them to a computer.



Photo

Scans items as photos and saves them to a computer.



Custom

Scans items with your favorite settings and saves the images to a computer. The item type can be automatically detected.



E-mail

You can send scanned images via e-mail.



OCR

Scan text in scanned magazines and newspapers and display it in a specified application.



Stitch

Displays the **Image Stitch** window in which you can scan the left and right halves of an item larger than the platen and combine the scanned images back into one image.



ScanGear

Starts ScanGear (scanner driver) in which you can make image corrections and color adjustments when scanning.



PDF Editor



Displays the [PDF edit screen](#) for creating or editing PDF files.

Settings Dialog Box

►►► Important

- Available functions, the displayed items, and available settings vary depending on your model.

The Settings dialog has the following three tabs.

-  (Scanning from a Computer) Tab
-  (Scanning from the Operation Panel) Tab
-  (General Settings) Tab

Click to open the corresponding tab and set the details of each function as needed.



(Scanning from a Computer) Tab

Set the default actions when scanning from IJ Scan Utility or IJ PDF Editor.

- ➔ [Settings \(Scanning from a Computer\) Dialog Box](#)



(Scanning from the Operation Panel) Tab

Set the default actions when scanning from the operation panel.

- ➔ [Settings \(Scanning from the Operation Panel\) Dialog Box](#)

►►► Important

- When the Settings dialog box is displayed from IJ PDF Editor, the  (Scanning from the Operation Panel) tab does not appear.



(General Settings) Tab

Set the model to use, file size restriction on e-mail attachment, language for detecting text in images, and the folder in which to save images temporarily.

- ➔ [Settings \(General Settings\) Dialog Box](#)

Settings (General Settings) Dialog Box



Click the  (General Settings) tab to display the **Settings (General Settings)** dialog box.

In the **Settings (General Settings)** dialog box, you can set the product to use, file size restriction on e-mail attachment, language to detect text in images, and folder in which to save images temporarily.

▶▶▶ Important

- The displayed items vary depending on your model.
- When the Settings dialog box is displayed from IJ PDF Editor, only **Product Name** appears.

Product Name

Displays the name of the product that IJ Scan Utility is currently set to use.

If the displayed product is not the one you want to use, select the desired product from the list.

In addition, for network connection, select one with "Network" after the product name.

▶▶▶ Note

- With network connection, **Select** appears on the right side of the product name. Click **Select** to display IJ Network Scanner Selector EX from which you can change the scanner to use. Refer to "[Network Scan Settings](#)" for the setting procedure.

E-mail Attachment Size

You can restrict the size of scanned images to be attached to an e-mail.

You can select **Small (Suitable for 640 x 480 Screen Resolution)**, **Medium (Suitable for 800 x 600 Screen Resolution)**, **Large (Suitable for 1024 x 768 Screen Resolution)**, or **No Change**.

Document Language

You can select the language for detecting text in images and for use with search when a PDF file that supports keyword search is created.

Folder to Save Temporary Files

Displays the folder in which to temporarily save images scanned with IJ Scan Utility or IJ PDF Editor. Click **Browse...** to specify the destination folder.

▶▶▶ Important

- If you change the **Folder to Save Temporary Files** while IJ PDF Editor is running, files will be saved to the previous folder. The change will be reflected after restarting IJ PDF Editor.

Instructions

Opens this guide.

Defaults

You can restore the settings in the displayed screen to the default settings.

Settings (Scanning from a Computer) Dialog Box

Click the item you want to scan on the  (Scanning from a Computer) tab to switch to the corresponding settings.

In the Settings (Scanning from a Computer) dialog box, you can set the default actions when scanning from IJ Scan Utility or IJ PDF Editor.

Important

- The displayed items vary depending on your model, the item you want to scan, or settings.

Note

- The following screen is displayed when **Auto Scan** is selected.

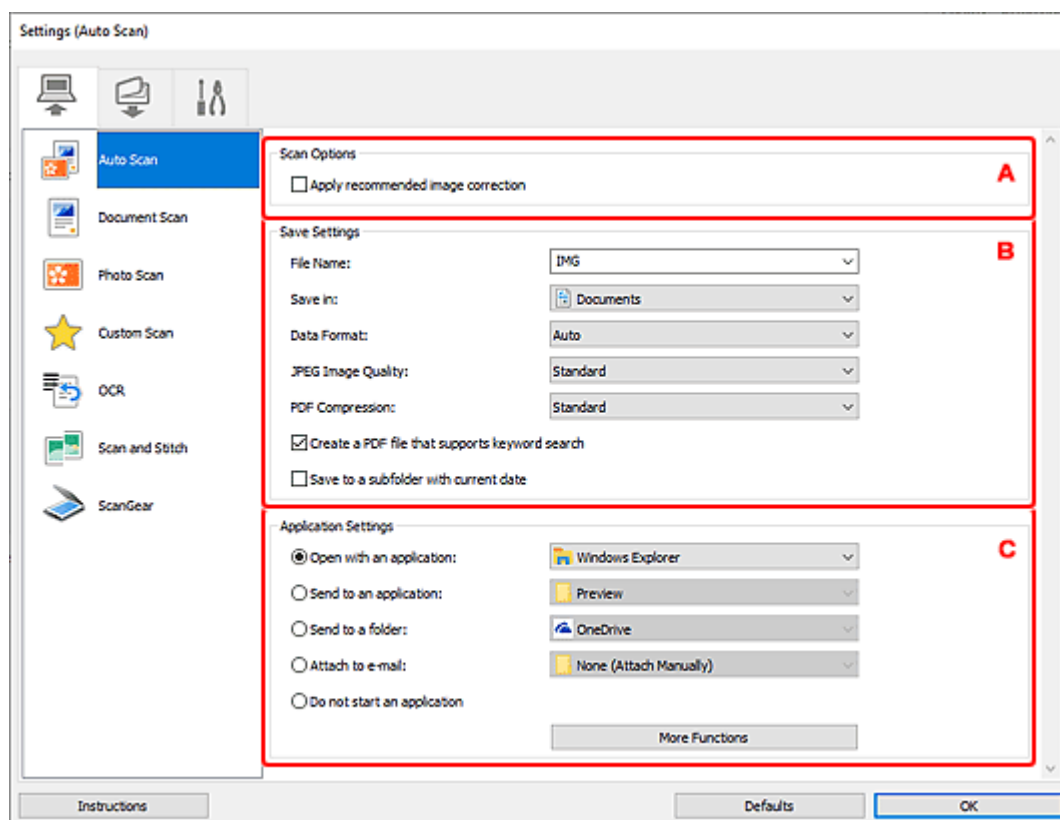

- ➔ [A: Scan Options Area](#)
- ➔ [B: Save Settings Area](#)
- ➔ [C: Application Settings Area](#)

A: Scan Options Area

Apply recommended image correction

Applies suitable corrections automatically based on the item type.

»» Important

- The color tone may differ from the source image due to corrections. In that case, deselect the checkbox and scan.

»» Note

- Scanning takes longer than usual when you enable this function.

Source Type

Select the type of item to be scanned.

- Automatically detecting the item: **Auto**
- Scanning documents: **Document** or **Document (ADF/Platen)**
- Scanning documents from the ADF (Auto Document Feeder): **Document (ADF Simplex)**, **Document (ADF Manual Duplex)**, **Document (ADF Duplex)**, or **Document (ADF/Platen)**
- Scanning magazines: **Magazine**
- Scanning photos: **Photo**

»» Important

- Item types supported by **Auto**: photos, postcards, business cards, magazines, newspapers, documents, BD/DVD/CD.
- To scan the following types of items, specify the item type or size. You cannot scan correctly with **Auto**.
 - A4 size photos
 - Text documents smaller than 2L (5 x 7 inches) (127 x 178 mm), such as paperback pages with the spine cut off
 - Items printed on thin white paper
 - Long narrow items such as panoramic photos
- Reflective disc labels may not be scanned as expected.
- Place items correctly according to the type of item to be scanned. Otherwise, items may not be scanned correctly.

Refer to "[Positioning Originals \(Scanning from Computer\)](#)" for how to place items.
- When scanning two or more documents from the ADF, place documents of the same size even if **Auto** is set.

»» Note

- To convert text in the image into text data after scanning, specify **Source Type** instead of selecting **Auto**.
- To reduce moire, set **Source Type** to **Magazine** or select the **Reduce moire** checkbox in **Image Processing Settings**.
- Select **Auto** to set **Color Mode**, **Original Size**, and **Resolution** automatically.
- When **Document (ADF/Platen)** is selected and documents are placed both on the platen and ADF, those placed on the ADF will be scanned.
- To scan both sides of each document at one time, select **Document (ADF/Platen)**, and then select the **Scan both sides when scanning from the ADF** checkbox.

Color Mode

Select the color mode in which to scan the item.

Original Size

Select the size of the item to be scanned.

When you select **Custom**, a screen in which you can specify the paper size appears. Select a **Unit**, then enter the **Width** and **Height**, and then click **OK**.

▶▶▶ Note

- Click **Defaults** to restore the specified settings to the default settings.

Resolution

Select the resolution of the item to be scanned.

The higher the resolution (value), the more detail in your image.

➔ [Resolution](#)

Original Scan Orientation Settings...

This appears when you select ADF for **Source Type**.

Click to display the **Original Scan Orientation Settings** dialog box in which you can set the orientation and binding side of the documents to be scanned from the ADF.

▶▶▶ Important

- **Binding Side** cannot be specified when scanning only the front side of each document.

Scan both sides when scanning from the ADF

This appears when you select **Document (ADF/Platen)** or **Auto** for **Source Type**. Scans both sides of the documents placed on the ADF.

Documents are scanned in the long-edge binding format, with the end inserted to the ADF being the upper end. The scanned documents are output in the back-to-front order.

Image Processing Settings

Click (Plus) to set the following.

Apply recommended image correction

Applies suitable corrections automatically based on the item type.

▶▶▶ Important

- The color tone may differ from the source image due to corrections. In that case, deselect the checkbox and scan.

▶▶▶ Note

- Scanning takes longer than usual when you enable this function.

Apply Auto Document Fix

Select this checkbox to sharpen text in a document or magazine for better readability.

▶▶▶ Important

- The color tone may differ from the source image due to corrections. In that case, deselect the checkbox and scan.

▶▶▶ Note

- Scanning takes longer than usual when you enable this function.

Sharpen outline

Emphasizes the outline of the subjects to sharpen the image.

Reduce show-through

Sharpens text in an item or reduces show-through in newspapers, etc.

Reduce moire

Reduces moire patterns.

Printed materials are displayed as a collection of fine dots. "Moire" is a phenomenon where uneven gradation or a stripe pattern appears when such photos or pictures printed with fine dots are scanned.

▶▶▶ Note

- Scanning takes longer than usual when you enable **Reduce moire**.

Correct gutter shadow/Correct gutter shadow (platen)

Reduces gutter shadows that appear between pages when scanning open booklets.

▶▶▶ Important

- This function is available only when scanning from the platen.

▶▶▶ Note

- Use ScanGear (scanner driver)'s **Advanced Mode** tab to correct gutter shadows when scanning non-standard size items or specified areas.
Refer to "[Gutter Shadow Correction](#)" for details.
- When you enable this function, scanning may take longer than usual with network connection.

Correct slanted text originals

Detects the scanned text and corrects the angle (within -0.1 to -10 degrees or +0.1 to +10 degrees) of the document.

▶▶▶ Important

- The following types of documents may not be corrected properly since the text cannot be detected correctly.
 - Documents in which the text lines are inclined more than 10 degrees or the angles vary by line
 - Documents containing both vertical and horizontal text
 - Documents with extremely large or small fonts
 - Documents with small amount of text
 - Documents containing figures/images
 - Hand-written text
 - Documents containing both vertical and horizontal lines (tables)

▶▶▶ Note

- Scanning takes longer than usual when you enable **Correct slanted text originals**.

Detect the orientation of text original and rotate image

Automatically rotates the image to the correct orientation by detecting the orientation of text in the scanned document.

»» Important

- Only text documents written in the language selected from **Document Language** in the [Settings \(General Settings\) dialog box](#) are supported.
- The orientation may not be detected for the following types of settings or documents since the text cannot be detected correctly.
 - Resolution is outside the range of 300 dpi to 600 dpi
 - Font size is outside the range of 8 points to 48 points
 - Documents containing special fonts, effects, italics, or hand-written text
 - Documents with patterned backgrounds

In that case, select the **Check scan results and specify save settings** checkbox, and then rotate the image in the **Save Settings** dialog box.

B: Save Settings Area

File Name

Enter the file name of the image to be saved. When you save a file, the date and four digits are appended to the set file name in the "_20XX0101_0001" format.

»» Note

- When you select the **Save to a subfolder with current date** checkbox, the date and four digits are appended to the set file name.

Save in

Displays the folder in which to save the scanned images. To add a folder, select **Add...** from the pull-down menu, then click **Add** in the displayed **Select Destination Folder** dialog box and specify the destination folder.

The default save folders are as follows.

- **Windows 11/Windows 10/Windows 8.1:**
Documents folder
- **Windows 7:**
My Documents folder

Data Format

Select the data format in which to save the scanned images.

You can select **JPEG/Exif**, **TIFF**, **PNG**, **PDF**, **PDF (Multiple Pages)**, or **Auto**.

»» Note

- When **Auto** is selected and the items are placed correctly, the scanned images are automatically saved in the following data formats.
 - Photos, postcards, BD/DVD/CD, and business cards: JPEG
 - Magazines, newspapers, and documents: PDF

Refer to "[Positioning Originals \(Scanning from Computer\)](#)" for how to place items.

- With network connection, scanning may take longer than usual when you set **TIFF** or **PNG** in **Data Format**.
- When **PDF** or **PDF (Multiple Pages)** is selected in **ScanGear**, images up to 9600 pixels x 9600 pixels can be scanned.

JPEG Image Quality

You can specify the image quality of JPEG files.

PDF Compression

Select the compression type for saving PDF files.

Standard

It is recommended that you normally select this setting.

High

Compresses the file size when saving, allowing you to reduce the load on your network/server.

Create a PDF file that supports keyword search

Select this checkbox to convert text in images into text data and create PDF files that support keyword search.

»» Note

- If text cannot be searched correctly, we recommend that you select 300 dpi or higher for **Resolution**.
- PDF files that are searchable in the language selected in **Document Language** on the (General Settings) tab of the Settings dialog box are created.



Save to a subfolder with current date

Select this checkbox to create a current date folder in the folder specified in **Save in** and save scanned images in it. The folder will be created with a name such as "20XX_01_01" (Year_Month_Date).

If this checkbox is not selected, files are saved directly in the folder specified in **Save in**.

Enable large image scans

Select this checkbox to scan images up to 21000 pixels x 30000 pixels and 1.8 GB.

»» Note

- When this checkbox is not selected, images up to 10208 pixels x 14032 pixels can be scanned.

Check scan results and specify save settings

Displays the **Save Settings** dialog box after scanning.

C: Application Settings Area

Open with an application

Select this when you want to enhance or correct the scanned images.

You can specify the application from the pull-down menu.

Send to an application

Select this when you want to use the scanned images as they are in an application that allows you to browse or organize images.

You can specify the application from the pull-down menu.

Send to a folder

Select this when you also want to save the scanned images to a folder other than the one specified in **Save in**.

You can specify the folder from the pull-down menu.

Attach to e-mail

Select this when you want to send e-mails with the scanned images attached.

You can specify the e-mail client you want to start from the pull-down menu.

Start OCR

Select this when you want to convert text in the scanned image into text data.

You can specify the application from the pull-down menu.

OCR Application

Displays the extracted text in a specified application.

▶▶▶ Note

- To add an application to the pull-down menu, select **Add...** from the pull-down menu, then click **Add** in the displayed **Select Application** dialog box and specify the application.

Do not start an application

Saves to the folder specified in **Save in**.

▶▶▶ Note

- To add an application or folder to the pull-down menu, select **Add...** from the pull-down menu, then click **Add** in the displayed **Select Application** or **Select Destination Folder** dialog box and specify the application or folder.

E-mail Client

Specify the e-mail client to use for attaching scanned images.

▶▶▶ Note

- To add an e-mail client to the pull-down menu, select **Add...** from the pull-down menu, then click **Add** in the displayed **Select Application** dialog box and specify the e-mail client.

Instructions

Opens this guide.

Defaults

You can restore the settings in the displayed screen to the default settings.

Settings (Scanning from the Operation Panel) Dialog Box

Click the item you want to scan on the  (Scanning from the Operation Panel) tab to switch to the corresponding settings.

In the Settings (Scanning from the Operation Panel) dialog box, you can set the default actions when scanning from the operation panel.

Important

- The displayed items vary depending on your model, the item you want to scan, or settings.

Note

- The following screen is displayed when **Save to Computer (Auto)** is selected.

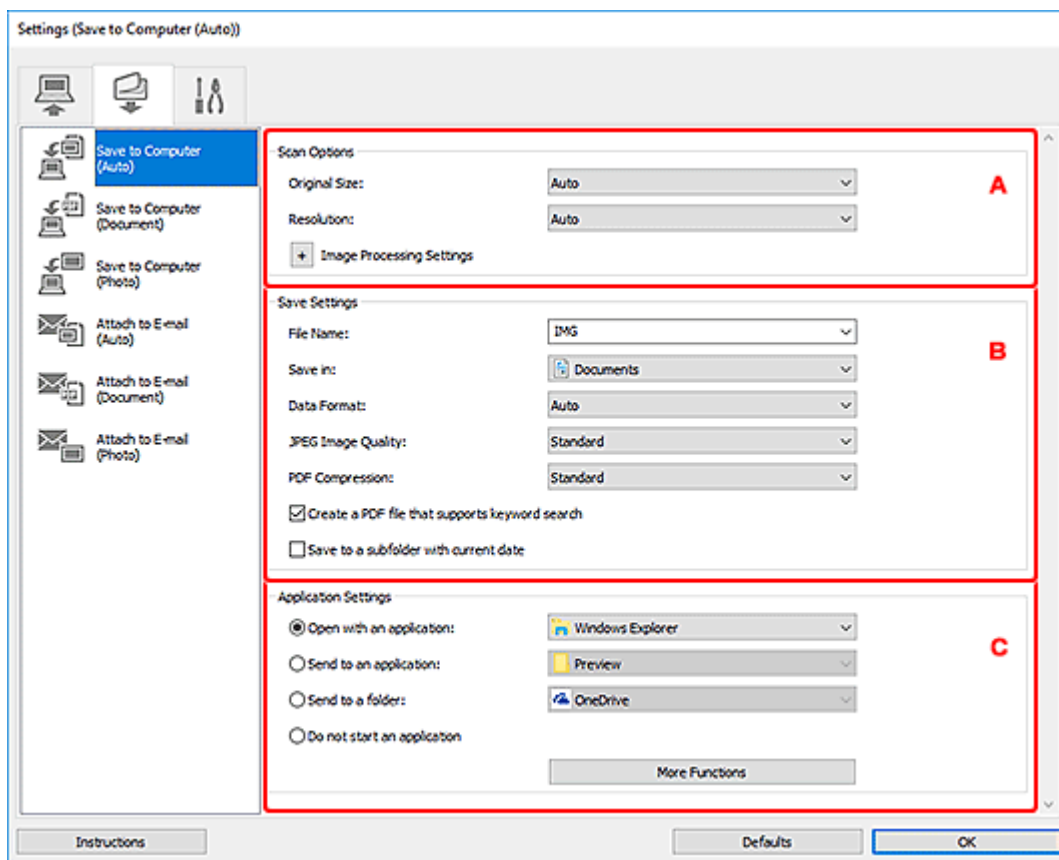

- ➔ [A: Scan Options Area](#)
- ➔ [B: Save Settings Area](#)
- ➔ [C: Application Settings Area](#)

A: Scan Options Area

Original Size

Set from the operation panel.

Resolution

Set from the operation panel.

Image Processing Settings

Click  (Plus) to set the following.

Apply recommended image correction

Applies suitable corrections automatically based on the item type.

▶▶▶ Important

- The color tone may differ from the source image due to corrections. In that case, deselect the checkbox and scan.

▶▶▶ Note

- Scanning takes longer than usual when you enable this function.

Apply Auto Document Fix

Select this checkbox to sharpen text in a document or magazine for better readability.

▶▶▶ Important

- The color tone may differ from the source image due to corrections. In that case, deselect the checkbox and scan.

▶▶▶ Note

- Scanning takes longer than usual when you enable this function.

Correct gutter shadow (platen)/Correct gutter shadow

Reduces gutter shadows that appear between pages when scanning open booklets.

▶▶▶ Important

- This function is available only when scanning from the platen.

▶▶▶ Note

- When you enable this function, scanning may take longer than usual with network connection.

Correct slanted text originals

Detects the scanned text and corrects the angle (within -0.1 to -10 degrees or +0.1 to +10 degrees) of the document.

▶▶▶ Important

- The following types of documents may not be corrected properly since the text cannot be detected correctly.
 - Documents in which the text lines are inclined more than 10 degrees or the angles vary by line
 - Documents containing both vertical and horizontal text
 - Documents with extremely large or small fonts
 - Documents with small amount of text
 - Documents containing figures/images
 - Hand-written text
 - Documents containing both vertical and horizontal lines (tables)

»» Note

- Scanning takes longer than usual when you enable **Correct slanted text originals**.

Detect the orientation of text original and rotate image

Automatically rotates the image to the correct orientation by detecting the orientation of text in the scanned document.

»» Important

- Only text documents written in languages that can be selected from **Document Language** in the [Settings \(General Settings\) dialog box](#) are supported.
- The orientation may not be detected for the following types of settings or documents since the text cannot be detected correctly.
 - Resolution is outside the range of 300 dpi to 600 dpi
 - Font size is outside the range of 8 points to 48 points
 - Documents containing special fonts, effects, italics, or hand-written text
 - Documents with patterned backgrounds

B: Save Settings Area

File Name

Enter the file name of the image to be saved. When you save a file, the date and four digits are appended to the set file name in the "_20XX0101_0001" format.

»» Note

- When you select the **Save to a subfolder with current date** checkbox, the date and four digits are appended to the set file name.

Save in

Displays the folder in which to save the scanned images. To add a folder, select **Add...** from the pull-down menu, then click **Add** in the displayed **Select Destination Folder** dialog box and specify the destination folder.

The default save folders are as follows.

- **Windows 11/Windows 10/Windows 8.1:**
Documents folder
- **Windows 7:**
My Documents folder

Data Format

Set from the operation panel.

»» Note

- When **Auto** is selected and the items are placed correctly, the scanned images are automatically saved in the following data formats.
 - Photos, postcards, BD/DVD/CD, and business cards: JPEG
 - Magazines, newspapers, and documents: PDF

Refer to "[Positioning Originals \(Scanning from Computer\)](#)" for how to place items.

JPEG Image Quality

You can specify the image quality of JPEG files.

PDF Compression

Select the compression type for saving PDF files.

Standard

It is recommended that you normally select this setting.

High

Compresses the file size when saving, allowing you to reduce the load on your network/server.

Create a PDF file that supports keyword search

Select this checkbox to convert text in images into text data and create PDF files that support keyword search.

»» Note

- PDF files that are searchable in the language selected in **Document Language** on the (General Settings) tab of the Settings dialog box are created.



Save to a subfolder with current date

Select this checkbox to create a current date folder in the folder specified in **Save in** and save scanned images in it. The folder will be created with a name such as "20XX_01_01" (Year_Month_Date).

If this checkbox is not selected, files are saved directly in the folder specified in **Save in**.

C: Application Settings Area

Open with an application

Select this when you want to enhance or correct the scanned images.

You can specify the application from the pull-down menu.

Send to an application

Select this when you want to use the scanned images as they are in an application that allows you to browse or organize images.

You can specify the application from the pull-down menu.

Send to a folder

Select this when you also want to save the scanned images to a folder other than the one specified in **Save in**.

You can specify the folder from the pull-down menu.

Do not start an application

Saves to the folder specified in **Save in**.

»» Note

- To add an application or folder to the pull-down menu, select **Add...** from the pull-down menu, then click **Add** in the displayed **Select Application** or **Select Destination Folder** dialog box and specify the application or folder.

E-mail Client

Specify the e-mail client to use for attaching scanned images.

You can specify the e-mail client you want to start from the pull-down menu.

»» Note

- To add an e-mail client to the pull-down menu, select **Add...** from the pull-down menu, then click **Add** in the displayed **Select Application** dialog box and specify the e-mail client.

Instructions

Opens this guide.

Defaults

You can restore the settings in the displayed screen to the default settings.

PDF Edit Screen

You can create PDF files by scanning items placed on the platen or ADF (Auto Document Feeder). Add, delete, rearrange pages, or make other edits in the created PDF files.

Open IJ PDF Editor, an application for creating/printing PDF files, by one of the following operations.

- Click **PDF Editor** in the [IJ Scan Utility main screen](#)
- Select **Canon IJ PDF Editor for Open with an application** in the [Settings \(Scanning from a Computer\) dialog box](#), and then scan by clicking **Document** in the [IJ Scan Utility main screen](#).

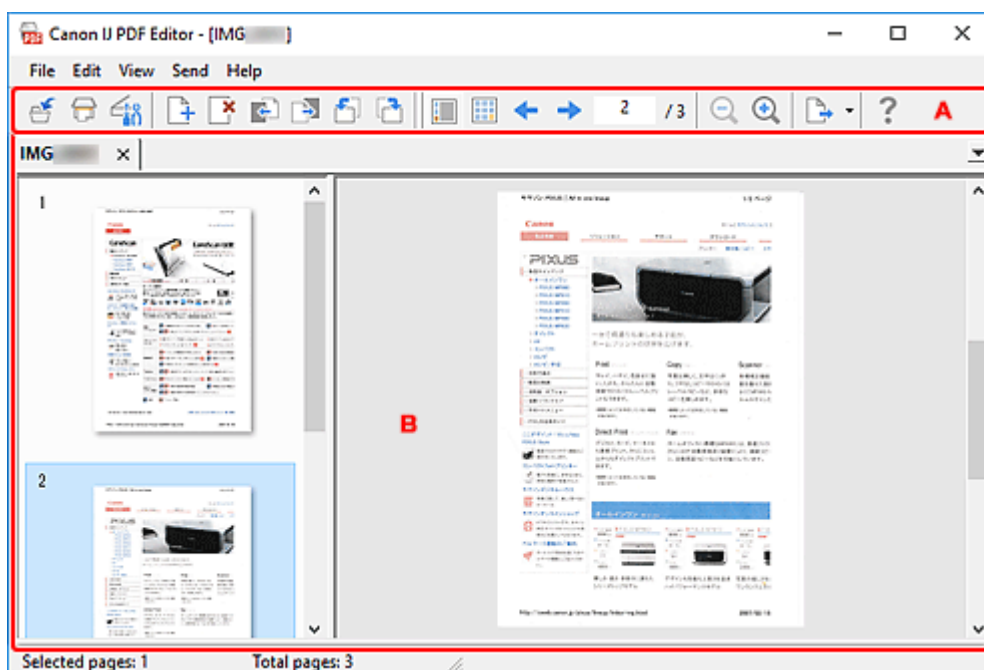

➔ [A: Toolbar](#)

➔ [B: Thumbnails Area](#)

A: Toolbar



(Save)

Overwrites the displayed PDF file. An existing PDF file can be overwritten once it is edited.

▶▶▶ Note

- You can also name and save the PDF file in the **Save** dialog box (PDF edit screen) by selecting **Save As...** in the **File** menu.



(Scan)

Starts scanning.



(Settings)

Displays the Settings dialog box of IJ Scan Utility for specifying how to respond when scanning.

**(Add Page)**

Displays the **Open** dialog box; select the image or PDF file you want to add, and then click **Open** to add a page to the end.

**(Delete Page)**

Deletes the selected page(s).

**(Move Up)**

Moves the selected page up one page.

**(Move Down)**

Moves the selected page down one page.

**(Rotate Left 90°)**

Rotates the selected page 90 degrees counter-clockwise.

**(Rotate Right 90°)**

Rotates the selected page 90 degrees clockwise.

**(Page View)**

Switches to [Page view](#) and displays the page thumbnails and a preview image.

**(Thumbnail View)**

Switches to [Thumbnail view](#) and displays a list of thumbnails of all pages in the PDF file.

**(Previous Page)**

Displays the page immediately before the displayed page.

**(Next Page)**

Displays the page immediately after the displayed page.

**(Specified Page)**

Enter a page number to display the specified page.

**(Reduce)**

Reduces the display size of the preview image displayed in [Page view](#).

**(Enlarge)**

Enlarges the display size of the preview image displayed in [Page view](#).

**(Send)****Open in PDF Viewer**

Open the saved PDF file in a PDF viewer.

Display Save Location

Displays the folder in which the PDF file is saved.

**(Instructions)**

Opens this guide.

B: Thumbnails Area

Displays the thumbnails of pages.

Change the page order via drag-and-drop.

From the Toolbar, switch between Page view and Thumbnail view.

►►► Note

- The following operations are available from the **Edit** menu.
 - **Undo**
Undoes the last operation.
 - **Select All**
Selects all the pages displayed in the Thumbnails area.
 - **Select Odd Pages**
Selects odd-numbered pages displayed in the Thumbnails area.
 - **Select Even Pages**
Selects even-numbered pages displayed in the Thumbnails area.

Page view:

The preview of the thumbnail selected on the left side appears on the right side.

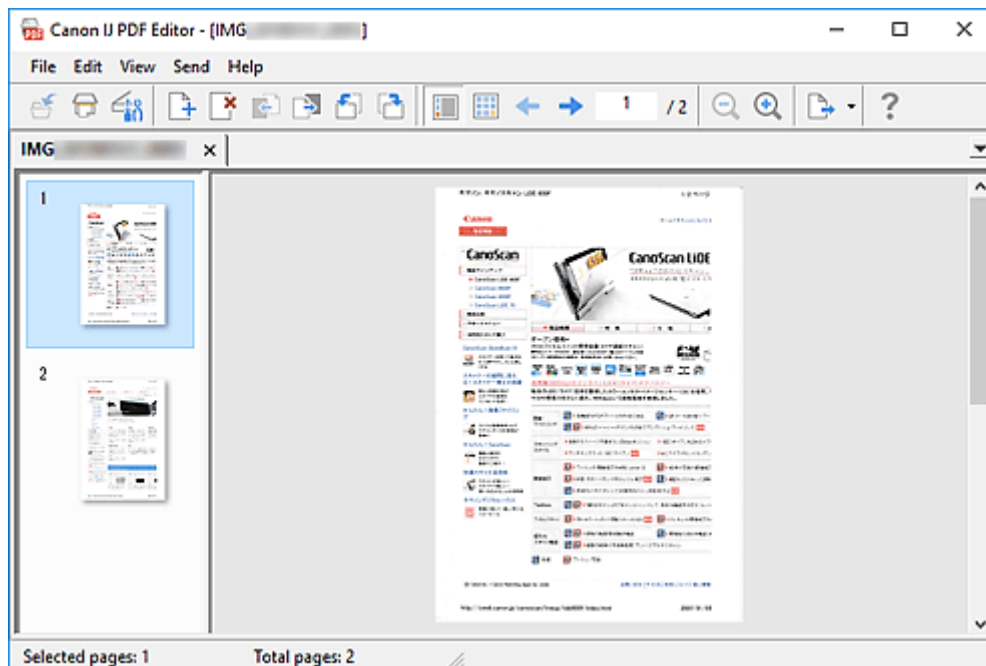

Thumbnail view:

Thumbnails appear in the page order from the top left.

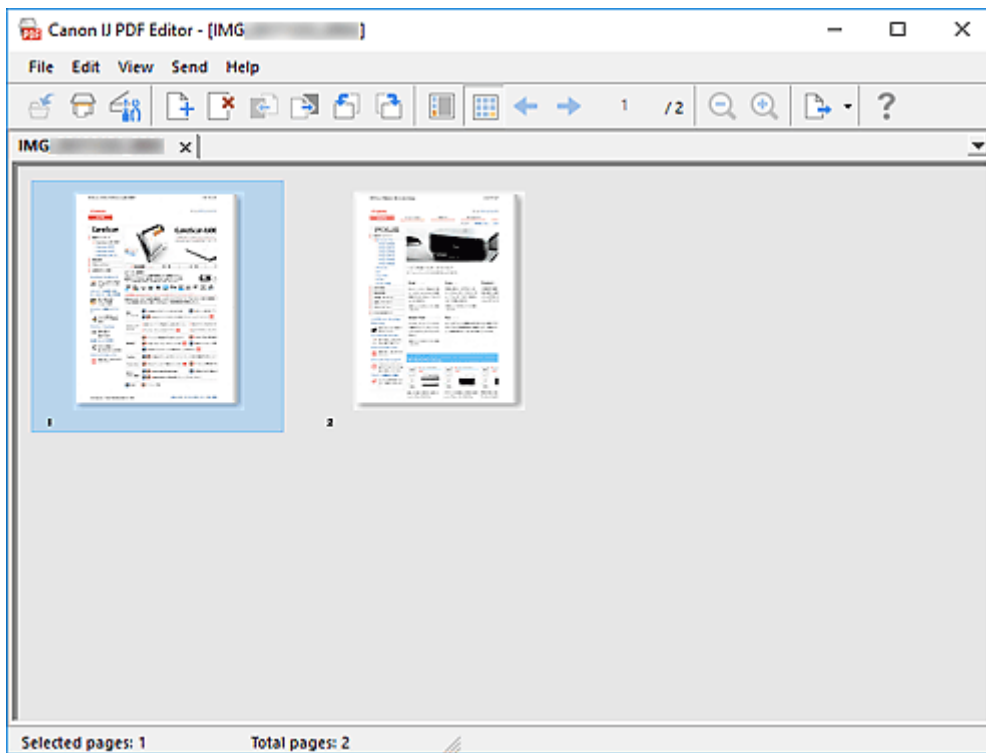

Scanning Using Application Software (ScanGear)

- ▶ **What Is ScanGear (Scanner Driver)?**
- ▶ **Starting ScanGear (Scanner Driver)**
- ▶ **Scanning in Basic Mode**
- ▶ **ScanGear (Scanner Driver) Screens**
- ▶ **General Notes (Scanner Driver)**
- ▶ **Scanning in Advanced Mode**
- ▶ **Scanning Multiple Documents at One Time with ScanGear (Scanner Driver)**
- ▶ **Correcting Images and Adjusting Colors with ScanGear (Scanner Driver)**
- ▶ **Positioning Originals (Scanning from Computer)**
- ▶ **Adjusting Cropping Frames (ScanGear)**
- ▶ **Updating the ScanGear (Scanner Driver)**

▶▶ Important

- Available functions and settings vary depending on your scanner or printer.

What Is ScanGear (Scanner Driver)?

ScanGear (scanner driver) is software required for scanning documents. Use the software to specify the output size, image corrections, and other settings.

ScanGear can be started from IJ Scan Utility or applications that are compatible with the standard TWAIN interface. (ScanGear is a TWAIN-compatible driver.)

Features

Specify the document type, output size, and other settings when scanning documents and preview scan results. Make various correction settings or finely adjust the brightness, contrast, and other parameters to scan in a specific color tone.

Screens

There are two modes: Basic Mode and Advanced Mode.

Switch modes with the tabs on the upper right of the screen.

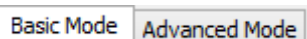

Note

- ScanGear starts in the last used mode.
- Settings are not retained when you switch modes.

Basic Mode

Use the **Basic Mode** tab to scan easily by following three simple on-screen steps (1 , 2 , and 3).

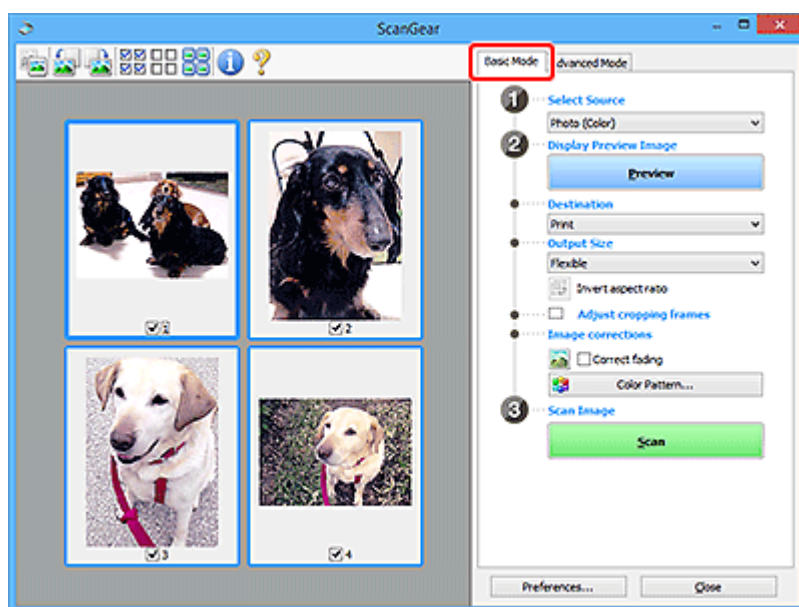

Advanced Mode

Use the **Advanced Mode** tab to scan by specifying the color mode, output resolution, image brightness, color tone, and other settings.

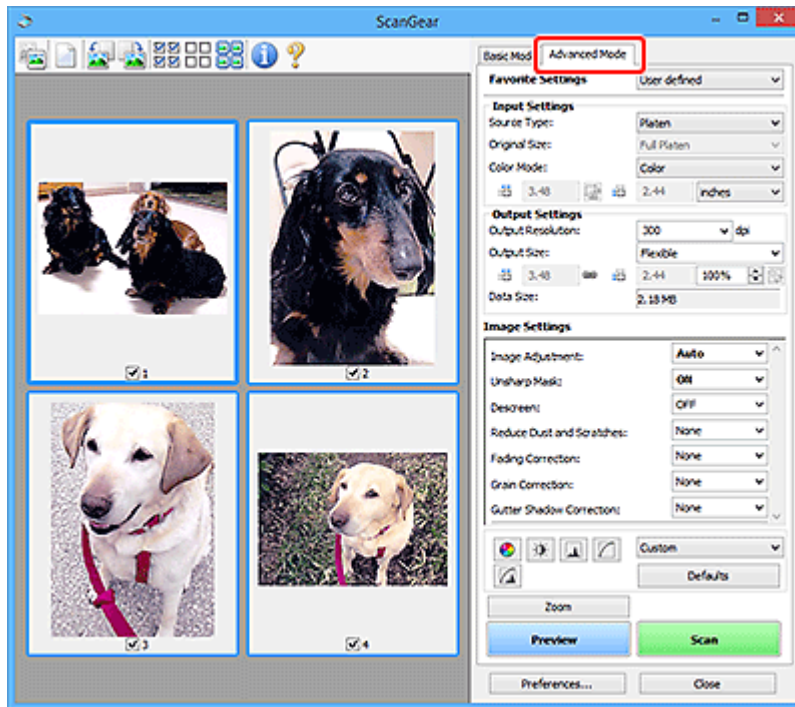

Starting ScanGear (Scanner Driver)

Use ScanGear (scanner driver) to make image corrections and color adjustments when scanning. Start ScanGear from IJ Scan Utility or other applications.

▶▶▶ Note

- If you have more than one scanner or have a network compatible model and changed the connection from USB connection to network connection, set up the network environment.

Starting from IJ Scan Utility

1. Start IJ Scan Utility.

For how to start it, see [Starting IJ Scan Utility](#).

2. In IJ Scan Utility main screen, click ScanGear.

The ScanGear screen appears.

Starting from Application

The procedure varies depending on the application. For details, see the application's manual.

1. Start application.
2. On application's menu, select machine.

▶▶▶ Note

- A machine connected over a network, will have "Network" displayed after the product name.

3. Scan document.

The ScanGear screen appears.

Scanning in Basic Mode

Use the **Basic Mode** tab to scan easily by following these simple on-screen steps.

To scan multiple documents at one time from the Platen, see [Scanning Multiple Documents at One Time with ScanGear \(Scanner Driver\)](#).

When scanning from the ADF (Auto Document Feeder), preview is not available.

Important

- The following types of documents may not be scanned correctly. In that case, click  (Thumbnail) on the Toolbar to switch to whole image view and scan.
 - Photos with a whitish background
 - Documents printed on white paper, hand-written text, business cards, and other unclear documents
 - Thin documents
 - Thick documents
- The following types of documents cannot be scanned correctly.
 - Documents smaller than 1.2 inches (3 cm) square
 - Photos that have been cut to irregular shapes

Note

- Both sides of a two sided document can be scanned simultaneously on models with ADF duplex scanning support.

1. Place document on machine's Platen or ADF, and then start ScanGear (scanner driver).

- ➔ [Positioning Originals \(Scanning from Computer\)](#)
- ➔ [Starting ScanGear \(Scanner Driver\)](#)

2. Set **Select Source** to match your document.

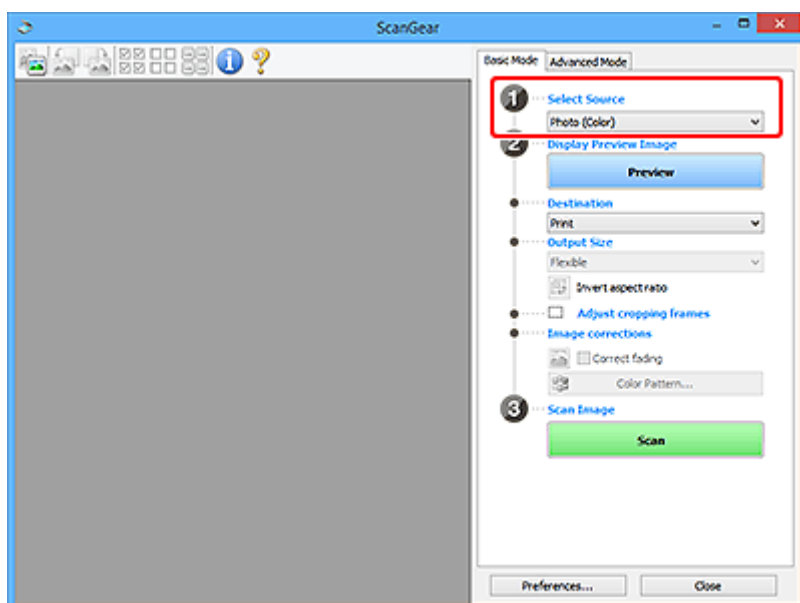

▶▶▶ Important

- Some applications do not support continuous scanning from the ADF. For details, see the application's manual.

▶▶▶ Note

- To scan magazines containing many color photos, select **Magazine (Color)**.

3. Click **Preview**.

Preview image appears in the Preview area.

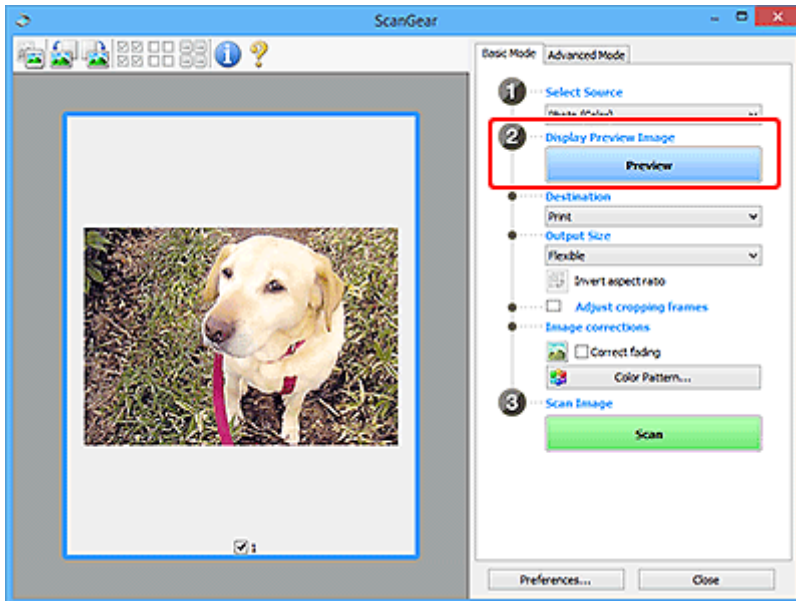

▶▶▶ Important

- **Preview** is not available when scanning from the ADF.

▶▶▶ Note

- Colors are adjusted based on the document type selected in **Select Source**.

4. Set **Destination**.

▶▶▶ Note

- Skip ahead to Step 7 if an ADF option is selected in **Select Source**.

5. Set **Output Size**.

Output size options vary with the selected **Destination**.

6. Adjust cropping frames (scan areas) as needed.

Adjust the size and position of the cropping frames on the preview image.

- ➔ [Adjusting Cropping Frames \(ScanGear\)](#)

7. Set **Image corrections** as needed.

8. Click **Scan**.

Scanning starts.

▶▶▶ Note

- Click  (Information) to display a dialog box showing the document type and other details of the current scan settings.
- How ScanGear behaves after scanning is complete can be set from **Status of ScanGear dialog after scanning** on the [Scan tab](#) of the **Preferences** dialog box.

Related Topic

➔ [Basic Mode Tab](#)

ScanGear (Scanner Driver) Screens

- **Basic Mode Tab**
- **Advanced Mode Tab**
- **Preferences Dialog Box**

Basic Mode Tab

Use the **Basic Mode** tab to scan easily by following these simple on-screen steps.

This section describes the settings and functions available on the **Basic Mode** tab.

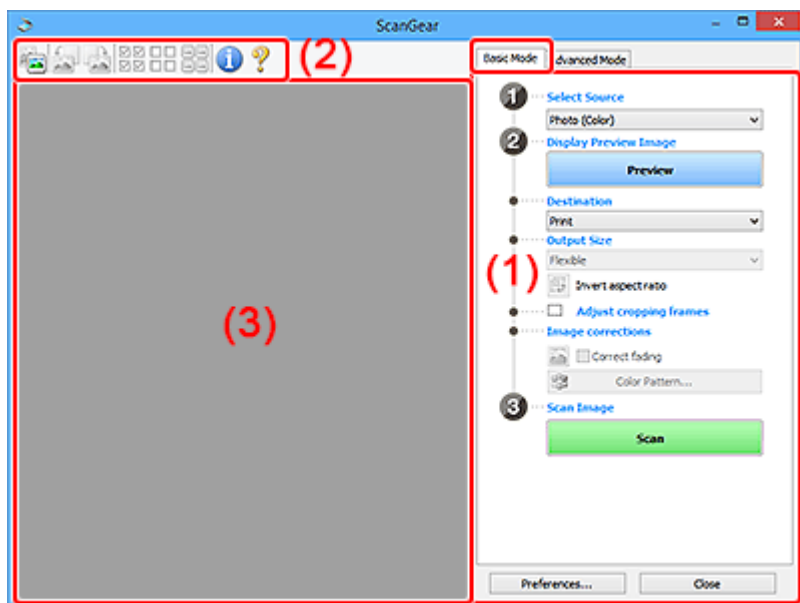

- ➔ [\(1\) Settings and Operation Buttons](#)
- ➔ [\(2\) Toolbar](#)
- ➔ [\(3\) Preview Area](#)

▶▶▶ Note

- The displayed items vary by document type and view.
- Preview is not available when scanning from the ADF (Auto Document Feeder).

(1) Settings and Operation Buttons

Select Source

Photo (Color)

Scan color photos.

Magazine (Color)

Scan color magazines.

Document (Color)

Scan documents in color.

Document (Grayscale)

Scan documents in black and white.

Document (Color) ADF Simplex

Scan documents from the ADF in color.

Document (Grayscale) ADF Simplex

Scan documents from the ADF in black and white.

Document (Color) ADF Duplex (only for models supporting ADF duplex scanning)

Scan both sides of documents from the ADF in color.

Document (Grayscale) ADF Duplex (only for models supporting ADF duplex scanning)

Scan both sides of documents from the ADF in black and white.

Important

- Some applications do not support continuous scanning from the ADF. For details, see the application's manual.

Note

- When you select a document type, the unsharp mask function will be active.
- When you select an option other than the ADF types, the image adjustment function which adjusts images based on the document type will also be active.
- When you select **Magazine (Color)**, the descreen function will be active.

Display Preview Image

Preview

Performs a trial scan.

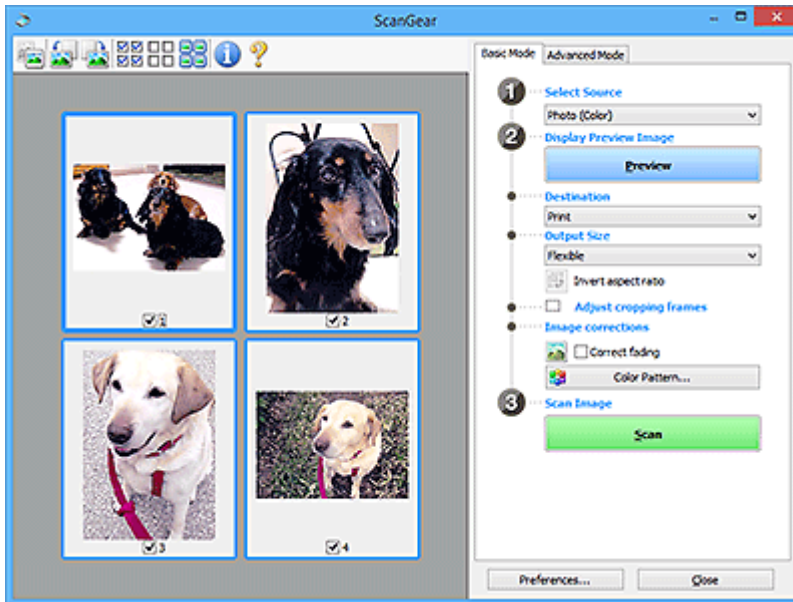

Note

- When using the machine for the first time, scanner calibration starts automatically. Wait a while until the preview image appears.

Destination

Select what you want to do with the scanned image.

Print

Select this to print the scanned image on a printer.

Image display

Select this to view the scanned image on a monitor.

OCR

Select this to use the scanned image with OCR software.

"OCR software" is software that converts text scanned as an image into text data that can be edited in word processors and other programs.

Output Size

Select an output size.

Output size options vary by the item selected in **Destination**.

Flexible

Adjust the cropping frames (scan areas) freely.

In thumbnail view:

Drag the mouse over a thumbnail to display a cropping frame. When a cropping frame is displayed, the portion within the cropping frame will be scanned. When no cropping frame is displayed, each frame is scanned individually.

In whole image view:

When no cropping frame is displayed, the entire Preview area will be scanned. When a cropping frame is displayed, the portion within the cropping frame will be scanned.

Paper Size (such as L or A4)

Select an output paper size. The portion within the cropping frame will be scanned at the size of the selected paper size. Drag the cropping frame to enlarge/reduce it while maintaining the aspect ratio.

Monitor Size (such as 1024 x 768 pixels)

Select an output size in pixels. A cropping frame of the selected monitor size will appear and the portion within the cropping frame will be scanned. Drag the cropping frame to enlarge/reduce it while maintaining the aspect ratio.

Add/Delete...

Displays the **Add/Delete the Output Size** dialog box for specifying custom output sizes. This option can be selected when **Destination** is **Print** or **Image display**.

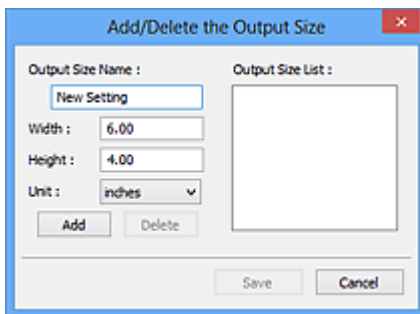

In the **Add/Delete the Output Size** dialog box, multiple output sizes can be specified and then saved at one time. Saved items will be registered to the **Output Size** list and can be selected, along with the predefined items.

Adding:

Enter **Output Size Name**, **Width**, and **Height**, and then click **Add**. For **Unit**, select **inches** or **mm** if **Destination** is **Print**; if it is **Image display**, only **pixels** can be selected. The name of the added size appears in **Output Size List**. Click **Save** to save the items listed in **Output Size List**.

Deleting:

Select the output size you want to delete in **Output Size List**, and then click **Delete**. Click **Save** to save the items listed in **Output Size List**.

►►► Important

- Predefined output sizes such as **A4** and **1024 x 768 pixels** cannot be deleted.

►►► Note

- Save up to 10 items.
- An error message appears when you enter a value outside the setting range. Enter a value within the setting range.

►►► Note

- For details on whether or how the cropping frame initially appears on a preview image, see **Cropping Frame on Previewed Images** in [Preview tab](#) of **Preferences** Dialog Box.



Invert aspect ratio

Available when **Output Size** is set to anything but **Flexible**.

Click this button to rotate the cropping frame. Click again to return it to the original orientation.

Adjust cropping frames

Adjust the scan area within the Preview area.

If an area is not specified, the document will be scanned at the document size (Auto Crop). If an area is specified, only the portion in the cropping frame will be scanned.

➔ [Adjusting Cropping Frames \(ScanGear\)](#)

Image corrections

Correct the image to be scanned.

►►► Important

- **Apply Auto Document Fix** and **Correct fading** are available when **Recommended** is selected on the **Color Settings** tab of the **Preferences** dialog box.

►►► Note

- Available functions vary by the document type selected in **Select Source**.

Apply Auto Document Fix

Sharpens text in a document or magazine for better readability.

►►► Important

- Scanning may take longer than usual when this checkbox is selected.
- The color tone may change from the source image due to corrections. In that case, deselect the checkbox and scan.
- Correction may not be applied properly if the scan area is too small.

Correct fading

Corrects photos that have faded with time or have a colorcast.

Correct gutter shadow

Corrects shadows that appear between pages when scanning open booklets.

►►► Important

- Be sure to see [Gutter Shadow Correction](#) for precautions and other information on using this function.

Color Pattern...

Adjust the image's overall color. Correct colors that have faded due to colorcast or other reasons and reproduce natural colors while previewing color changes.

➔ [Adjusting Colors Using a Color Pattern](#)

►►► Important

- This setting is not available when **Color Matching** is selected on the **Color Settings** tab of the **Preferences** dialog box.

Scan Image

Scan

Starts scanning.

►►► Note

- When scanning starts, the progress appears. To cancel the scan, click **Cancel**.

Preferences...

Displays the [Preferences dialog box](#) for making scan/preview settings.

Close

Closes ScanGear (scanner driver).

(2) Toolbar

Adjust or rotate preview images. The buttons displayed on the Toolbar vary by view.

In thumbnail view:



In whole image view:



Switches the view in the Preview area.

➔ [\(3\) Preview Area](#)



Rotates the preview image 90 degrees counter-clockwise.

- The result will be reflected in the scanned image.

- The image returns to its original state when you preview again.



(Rotate Right)

Rotates the preview image 90 degrees clockwise.

- The result will be reflected in the scanned image.
- The image returns to its original state when you preview again.



(Auto Crop)

Displays and adjusts the cropping frame automatically to the size of the document displayed in the Preview area. The scan area is reduced every time you click this button if there are croppable areas within the cropping frame.



(Check All Frames)

Available when two or more frames are displayed.

Selects the checkboxes of the images in thumbnail view.



(Uncheck All Frames)

Available when two or more frames are displayed.

Deselects the checkboxes of the images in thumbnail view.



(Select All Frames)

Available when two or more frames are displayed.

Selects the images in thumbnail view and outlines them in blue.



(Select All Cropping Frames)

Available when two or more cropping frames are specified.

Turns the cropping frames into thick broken lines and applies the settings to all of them.



(Remove Cropping Frame)

Removes the selected cropping frame.



(Information)

Displays the version of ScanGear, along with the document type and other details of the current scan settings.



(Open Guide)

Opens this page.

(3) Preview Area



This is where a trial image appears after you click **Preview**. The results of image corrections, color adjustments, and other settings made in [\(1\) Settings and Operation Buttons](#) are also reflected.

When  (Thumbnail) is displayed on Toolbar:

Cropping frames are specified according to the document size, and thumbnails of scanned images appear. Only the images with the checkbox selected will be scanned.



►► Note

- When multiple images are previewed, different outlines indicate different selection status.
 - Focus Frame (thick blue outline): The displayed settings will be applied.
 - Selected Frame (thin blue outline): The settings will be applied to the Focus Frame and Selected Frames simultaneously. To select multiple images, click them while pressing the Ctrl key.
 - Unselected (no outline): The settings will not be applied.
- Double-click a frame to enlarge the image. Click   (Frame Advance) at the bottom of the screen to display the previous or next frame. Double-click the enlarged frame again to return it to its original state.

When  (Whole Image) is displayed on Toolbar:

Items on the Platen are scanned and appear as a single image. All portions in the cropping frames will be scanned.



▶▶ Note

- Create cropping frame(s) on the displayed image. In thumbnail view, one cropping frame can be created per image. In whole image view, multiple cropping frames can be created.

➔ [Adjusting Cropping Frames \(ScanGear\)](#)

Related Topic

➔ [Scanning in Basic Mode](#)

Advanced Mode Tab

This mode allows you to make advanced scan settings such as the color mode, output resolution, image brightness, and color tone.

This section describes the settings and functions available on the **Advanced Mode** tab.

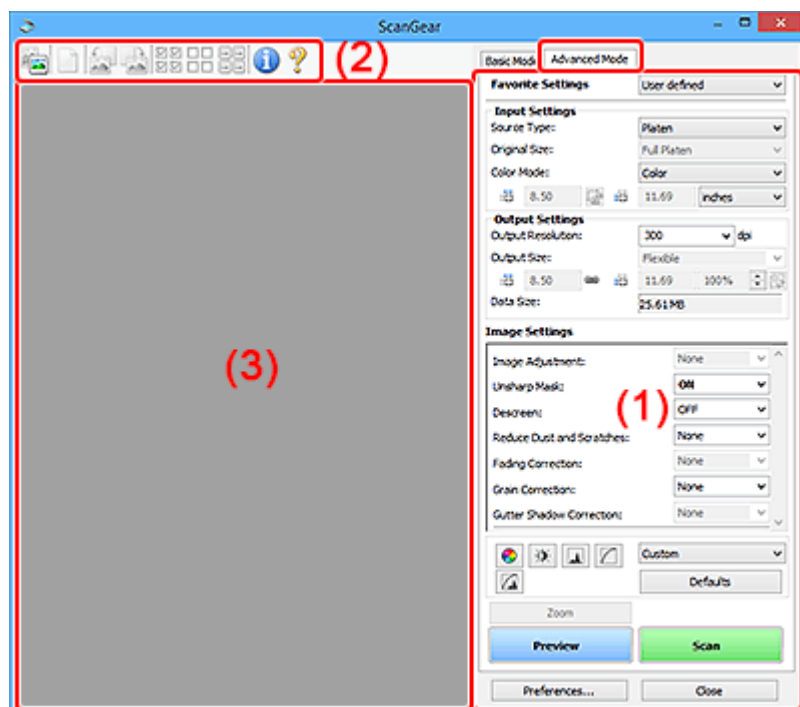

- ➔ [\(1\) Settings and Operation Buttons](#)
- ➔ [\(2\) Toolbar](#)
- ➔ [\(3\) Preview Area](#)

▶▶▶ Important

- The displayed items vary depending on your model, document type, and view.
- The preview function is not available when scanning from the ADF (Auto Document Feeder).

(1) Settings and Operation Buttons

Favorite Settings

You can name and save a group of settings (Input Settings, Output Settings, Image Settings, and Color Adjustment Buttons) on the **Advanced Mode** tab, and load it as required. It is convenient to save a group of settings if you will be using it repeatedly. You can also use this to reload the default settings.

Select **Add/Delete...** from the pull-down menu to open the **Add/Delete Favorite Settings** dialog box.

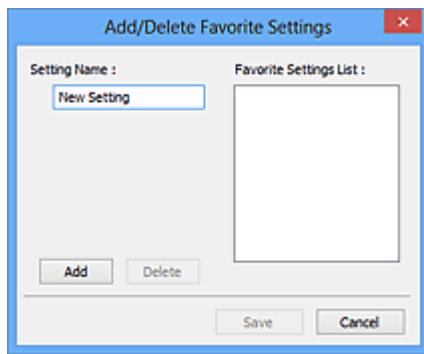

Enter **Setting Name** and click **Add**; the name appears in **Favorite Settings List**.

When you click **Save**, the item appears in the **Favorite Settings** list and can be selected, along with the predefined items.

To delete an item, select it in **Favorite Settings List** and click **Delete**. Click **Save** to save the settings displayed in **Favorite Settings List**.

▶▶▶ Note

- You can set **Add/Delete...** in **Favorite Settings** after preview.
- Save up to 10 items.

[Input Settings](#)

Specify the input settings such as the document type and size.

[Output Settings](#)

Specify the output settings such as the output resolution and size.

[Image Settings](#)

Enable/disable various image correction functions.

[Color Adjustment Buttons](#)

Fine corrections to the image brightness and color tones can be made including adjustments to the image's overall brightness or contrast and adjustments to its highlight and shadow values (histogram) or balance (tone curve).

Zoom

Zooms in on a frame, or zooms in on the image in the area specified with a cropping frame (scan area). When zoomed in, **Zoom** changes to **Undo**. Click **Undo** to return the display to its non-magnified state.

In thumbnail view:

When multiple images are displayed in thumbnail view, clicking this button zooms in on the selected frame. Click  (Frame Advance) at the bottom of the screen to display the previous or next frame.

▶▶▶ Note

- You can also zoom in on an image by double-clicking the frame. Double-click the enlarged frame again to return it to its original state.

In whole image view:

Rescans the image in the area specified with a cropping frame at higher magnification.

►►► Note

- **Zoom** rescans the document and displays high-resolution image in Preview.
-  (Enlarge/Reduce) on the Toolbar zooms in on the preview image quickly. However, the resolution of the displayed image will be low.

Preview

Performs a trial scan.

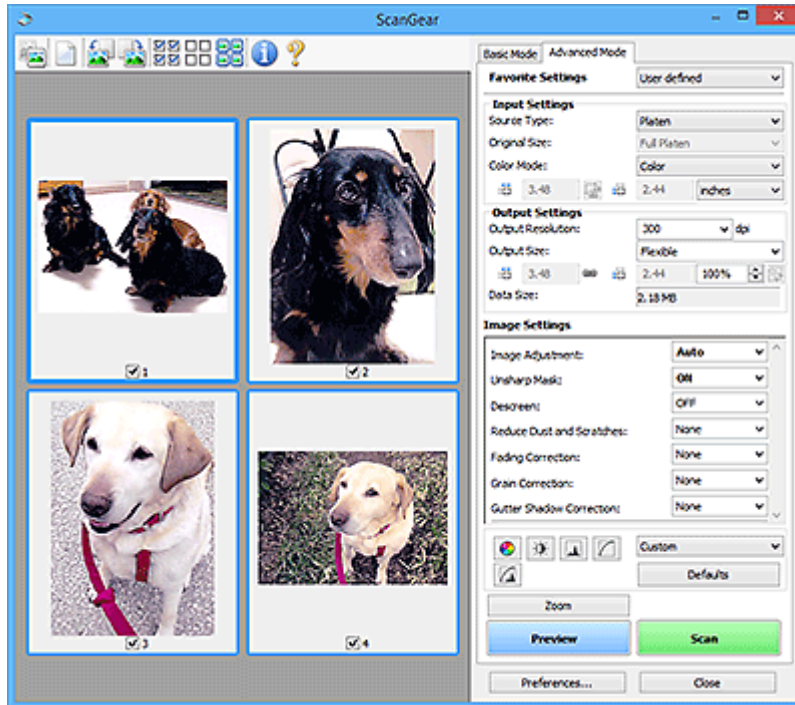

Scan

Starts scanning.

►►► Note

- When scanning starts, the progress appears. To cancel the scan, click **Cancel**.
- When scanning is completed, a dialog box prompting you to select the next action may appear. Follow the prompt to complete. For details, see **Status of ScanGear dialog after scanning** in [Scan tab](#) of **Preferences** dialog box.
- It will take time to process the images if the total size of the scanned images exceeds a certain size. In that case, a warning message appears; it is recommended that you reduce the total size. To continue, scan in whole image view.

Preferences...

Displays the [Preferences dialog box](#) for making scan/preview settings.

Close

Closes ScanGear (scanner driver).

(2) Toolbar

Adjust or rotate preview images. The buttons displayed on the Toolbar vary by view.

In thumbnail view:



In whole image view:



Switches the view in the Preview area.

➔ [\(3\) Preview Area](#)



(Clear)

Deletes the preview image from the Preview area.

It also resets the Toolbar and color adjustment settings.



(Crop)

Allows you to specify the scan area by dragging the mouse.



(Move Image)

Allows you to drag the image until the part you want to see is displayed when an image enlarged in the Preview area does not fit in the screen. You can also move the image using the scroll bars.



(Enlarge/Reduce)

Allows you to zoom in on the Preview area by clicking the image. Right-click the image to zoom out.



(Rotate Left)

Rotates the preview image 90 degrees counter-clockwise.

- The result will be reflected in the scanned image.
- The image returns to its original state when you preview again.



(Rotate Right)

Rotates the preview image 90 degrees clockwise.

- The result will be reflected in the scanned image.
- The image returns to its original state when you preview again.



(Auto Crop)

Displays and adjusts the cropping frame automatically to the size of the document displayed in the Preview area. The scan area is reduced every time you click this button if there are croppable areas within the cropping frame.



(Check All Frames)

Available when two or more frames are displayed.

Selects the checkboxes of the images in thumbnail view.



(Uncheck All Frames)

Available when two or more frames are displayed.

Deselects the checkboxes of the images in thumbnail view.



(Select All Frames)

Available when two or more frames are displayed.

Selects the images in thumbnail view and outlines them in blue.



(Select All Cropping Frames)

Available when two or more cropping frames are specified.

Turns the cropping frames into thick broken lines and applies the settings to all of them.



(Remove Cropping Frame)

Removes the selected cropping frame.



(Information)

Displays the version of ScanGear, along with the document type and other details of the current scan settings.



(Open Guide)

Opens this page.

(3) Preview Area

This is where a trial image appears after you click **Preview**. The results of image corrections, color adjustments, and other settings made in [\(1\) Settings and Operation Buttons](#) are also reflected.

When  (Thumbnail) is displayed on Toolbar:

Cropping frames are specified according to the document size, and thumbnails of scanned images appear. Only the images with the checkbox selected will be scanned.



►► Note

- When multiple images are previewed, different outlines indicate different selection status.
 - Focus Frame (thick blue outline): The displayed settings will be applied.
 - Selected Frame (thin blue outline): The settings will be applied to the Focus Frame and Selected Frames simultaneously. To select multiple images, click them while pressing the Ctrl key.
 - Unselected (no outline): The settings will not be applied.

When  (Whole Image) is displayed on Toolbar:

Items on the Platen are scanned and appear as a single image. All portions in the cropping frames will be scanned.



►► Note

- Create cropping frame(s) on the displayed image. In thumbnail view, one cropping frame can be created per image. In whole image view, multiple cropping frames can be created.
 - ➔ [Adjusting Cropping Frames \(ScanGear\)](#)

Related Topic

- ➔ [Scanning in Advanced Mode](#)
- ➔ Scanning Multiple Documents from the ADF (Auto Document Feeder) in Advanced Mode

Input Settings

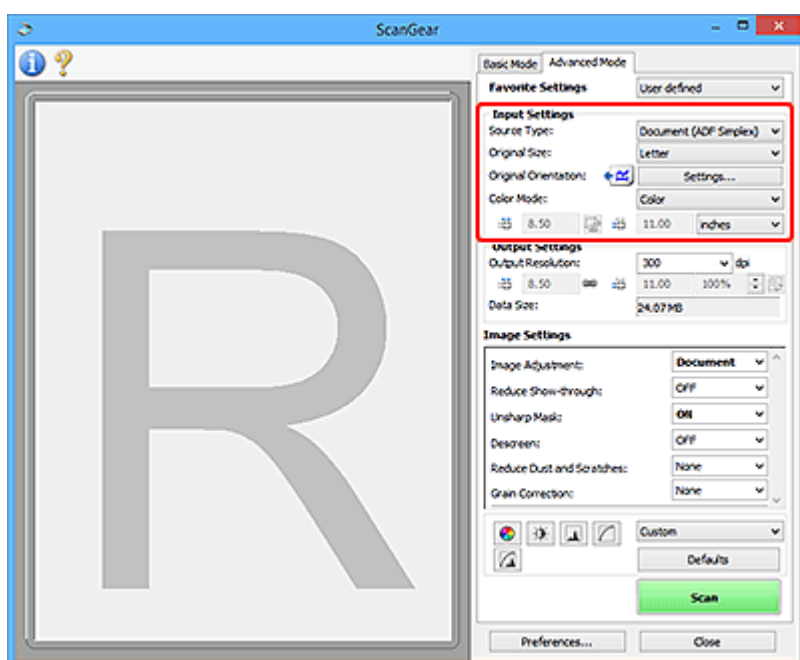

Input Settings allows you to set the following items:

►►► Important

- Available functions and settings vary depending on your scanner or printer.

Select Source

The type of document to be scanned is displayed. To scan from the Platen, select **Platen**; to scan from the ADF (Auto Document Feeder), select **Document (ADF Simplex)** or **Document (ADF Duplex)**.

►►► Important

- Some applications do not support continuous scanning from the ADF. For details, see the application's manual.

►►► Note

- You can select **Document (ADF Duplex)** when using a model supporting ADF duplex scanning.

Original Size



Select the size of the document to be scanned. This setting is available in whole image view only.

When you select a size, the Preview area size changes accordingly.

►►► Important

- Some applications have a limit to the amount of scan data they can receive. Available scan range is as follows.
 - 21000 pixels x 30000 pixels or less (and 1.8 GB or less in data size)
- If you change **Original Size** after previewing, the preview image will be deleted.

►►► Note

- If you are not sure which size you should select for **Original Size**, set **Original Size** to **Full Platen**, then measure the size of the document and enter the values into  (Width) and  (Height).

Original Orientation

Set the orientation and stapling side of the documents to scan from the ADF.

Click **Settings...** to open the **Orientation** dialog box.

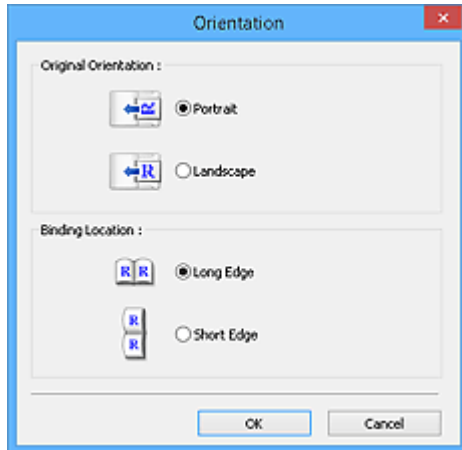

►►► Important

- The **Orientation** dialog box can only be opened when **Select Source** is **Document (ADF Simplex)** or **Document (ADF Duplex)**.
- **Binding Location** is displayed when using a model supporting ADF duplex scanning.
- **Binding Location** cannot be specified when **Select Source** is **Document (ADF Simplex)**.

Color Mode

Select how to scan the document.

Color

Select this mode to scan color documents or to create color images. This mode renders the image in 256 levels (8 bit) of R(ed), G(reen), and B(lue).

Color (48bit)

Select this mode to scan color photos. This mode renders the image in 65536 levels (16 bit) of R(ed), G(reen), and B(lue).

►►► Important

- Some applications cannot display images scanned in **Color (48bit)**.
- **Color (48bit)** is displayed only when the **Enable 48/16 bit output** checkbox is selected on the [Scan tab](#) of the **Preferences** dialog box.

Grayscale

Select this mode to scan black and white photos or to create black and white images. This mode renders the image in 256 levels (8 bit) of black and white.

Black and White



Select this mode to scan photos and documents in black and white. This mode renders the image in black and white. The contrast in the image is divided at certain levels (threshold level) into black and white and is rendered in two colors. The threshold level can be set with  (Threshold).

Input Size

In thumbnail view, the cropped document size is displayed after preview.

In whole image view, the **Original Size** is displayed before preview, and the cropping frame (scan area) size is displayed after preview.

You can adjust the cropping frame size by entering the values into  (Width) and  (Height).

Click  (Change Aspect Ratio) and change it to  (Keep Aspect Ratio) to maintain the aspect ratio when you specify the cropping frame size.

►► Important

- Input size settings are available only when **Output Size** in **Output Settings** is **Flexible**. If you select a size other than **Flexible**, a cropping frame calculated from **Output Size** and **Output Resolution** is displayed, and its aspect ratio is fixed.

►► Note

- The values you can enter will be within the range of the selected document size. The minimum size is 96 pixels x 96 pixels when **Output Resolution** is 600 dpi, scaled at 100 %.
- When Auto Crop is performed in whole image view, the aspect ratio will not be maintained since the size will be prioritized.
- Refer to "[Adjusting Cropping Frames \(ScanGear\)](#)" for details on cropping frames.

Output Settings

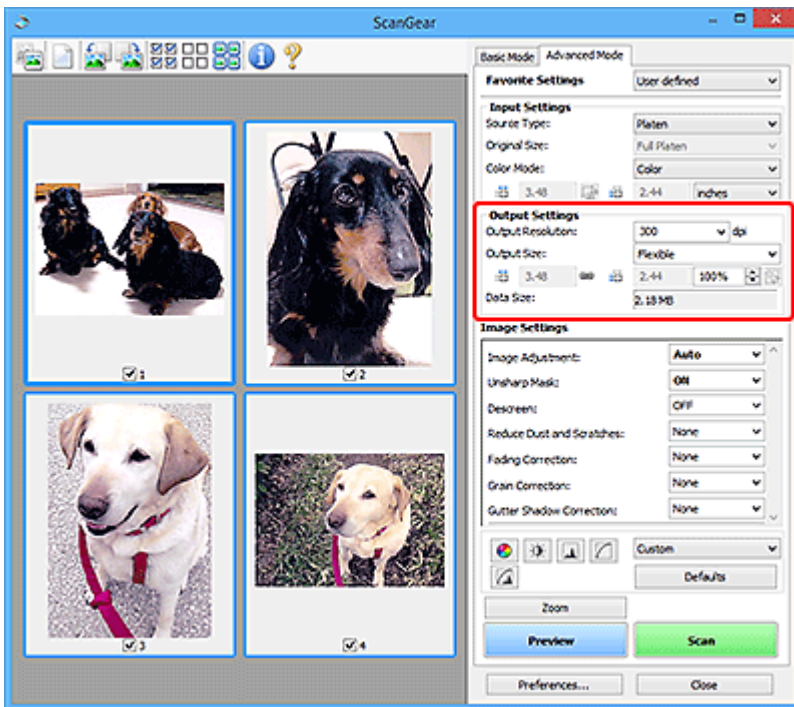

Output Settings allows you to set the following items:

Output Resolution

Select the resolution to scan at.

The higher the resolution (value), the more detail in your image.

Select a resolution from the options displayed by clicking the button, or enter a value within the range of 25 dpi to 19200 dpi (in 1 dpi increments).

For details on the resolution, see [Resolution](#).

When Select Source is Platen:

You can enter a value within the range of 25 dpi to 19200 dpi.

When Select Source is Document (ADF Simplex) or Document (ADF Duplex):

You can enter a value within the range of 25 dpi to 600 dpi.

►►► Note

- When preview images are in thumbnail view, entering 1201 dpi or a greater value will set **Output Resolution** as follows.
 - When you enter 1201 dpi to 2399 dpi: 2400 dpi
 - When you enter 2401 dpi to 4799 dpi: 4800 dpi
 - When you enter 4801 dpi to 9599 dpi: 9600 dpi
 - When you enter 9601 dpi to 19199 dpi: 19200 dpi

Output Size

Select an output size.

Select **Flexible** to set custom sizes or select a size for printing or displaying. Select **Add/Delete...** to set custom size and save it as a new output size option.

Flexible

You can specify the output resolution and scale, and adjust the cropping frames (scan areas).



In thumbnail view:

Drag the mouse over a thumbnail to display a cropping frame. When a cropping frame is displayed, the portion within the cropping frame will be scanned. When no cropping frame is displayed, each frame is scanned individually.



In whole image view:

When no cropping frame is displayed, the entire Preview area will be scanned. When a cropping frame is displayed, the portion within the cropping frame will be scanned.

➤➤➤ Note

- To enlarge/reduce the scanned image, enter values into  (Width) and  (Height) in **Output Settings** or specify a value (by 1 %) for %. Although the maximum value available for % depends on the **Output Resolution**, it can be specified for up to 19200 dpi (the maximum available output resolution).

Paper Size (L, A4, etc.) & Monitor Size (1024 x 768 pixels, etc.)

 (Width),  (Height), and scale cannot be specified. The preview image will be cropped according to the selected output size and resolution. The portion within the cropping frame will be scanned at the size of the selected paper/monitor size. You can drag the cropping frame to enlarge, reduce, or move it while maintaining the aspect ratio.

Add/Delete...

Displays the **Add/Delete the Output Size** dialog box for specifying custom output sizes.

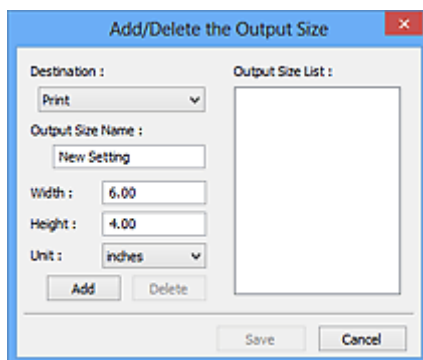

In the **Add/Delete the Output Size** dialog box, multiple output sizes can be specified and then saved at one time. Saved items will be registered to the **Output Size** list and can be selected, along with the predefined items.

Adding:

Select **Print** or **Image display** for **Destination**, then enter **Output Size Name**, **Width**, and **Height**, then click **Add**. For **Unit**, you can select **inches** or **mm** when **Destination** is **Print** but you can only select **pixels** when **Destination** is **Image display**. The name of the added size appears in **Output Size List**. Click **Save** to save the items listed in **Output Size List**.

Deleting:

Select the output size you want to delete in **Output Size List**, and then click **Delete**. Click **Save** to save the items listed in **Output Size List**.

►► Important

- Predefined output sizes such as **A4** and **1024 x 768 pixels** cannot be deleted.

►► Note

- Save up to 10 items for each destination.
- An error message appears when you enter a value outside the setting range. Enter a value within the range displayed in the message.

►► Note

- Refer to "[Adjusting Cropping Frames \(ScanGear\)](#)" for details on cropping frames.
- For details on whether or how the cropping frame initially appears on a preview image, see **Cropping Frame on Previewed Images** in [Preview tab](#) of **Preferences** Dialog Box.



(Switch Aspect Ratio)

Available when **Output Size** is set to anything but **Flexible**.

Click this button to rotate the cropping frame. Click again to return it to the original orientation.

Data Size

The data size when scanned with the current settings is displayed.

►► Note

- When the data size exceeds a certain size, the value appears in red. In that case, a warning message appears when you click **Scan**. It is recommended that you adjust the settings to reduce **Data Size**. To continue, scan in whole image view.

Image Settings

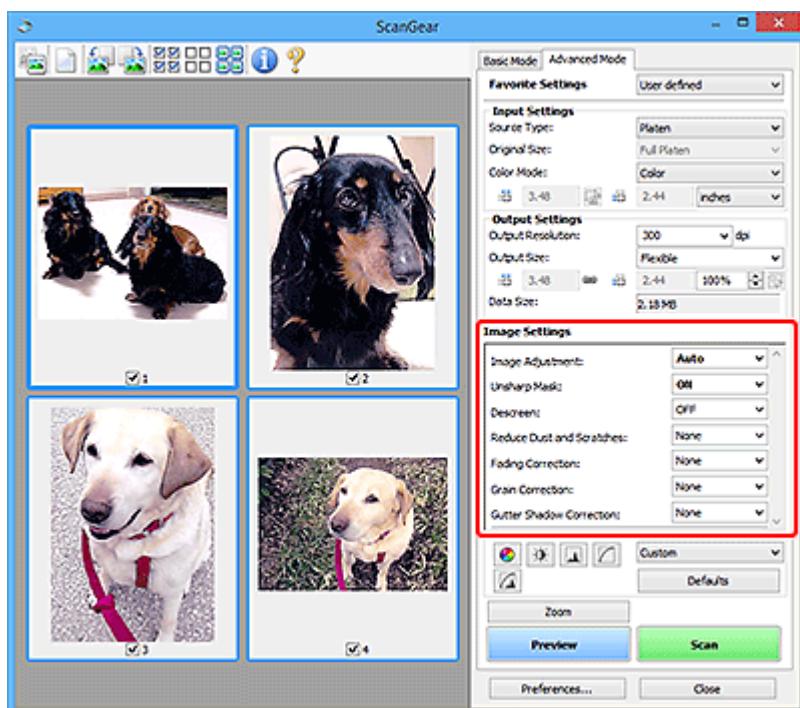

►► Important

- Do not apply these functions to images without moire, dust/scratches, or faded colors. The color tone may be adversely affected.
- Image correction results may not be reflected in the preview image.

►► Note

- Selectable settings depend on **Color Mode** settings.
- Scanning may take longer than usual when you use **Image Settings**.

Image Settings allows you to set the following items:

Image Adjustment

When Image Adjustment is set, the brightness of the specified portion of the image is optimized. Images can be adjusted according to the automatically detected document type or the specified document type. The result of the adjustment will be reflected in the entire image.

None

Image Adjustment will not be applied.

Auto

Applies Image Adjustment by automatically detecting the document type. It is recommended that you normally select this setting.

Photo

Applies Image Adjustment suitable for photos.

Magazine

Applies Image Adjustment suitable for magazines.

Document

Applies Image Adjustment suitable for text documents.

►►► Important

- You can set **Image Adjustment** after preview.
- You can set this setting when **Recommended** is selected on the **Color Settings** tab of the **Preferences** dialog box.

►►► Note

- If the image is not adjusted properly with **Auto**, specify the document type.
- The color tone may change from the source image due to the Image Adjustment. In that case, set **Image Adjustment** to **None**.

Reduce Show-through

Use this function to reduce show-through in duplex documents or lighten the base color in recycled paper and other colored paper when scanning documents.

OFF

Show-through will not be reduced.

ON

Select this to reduce show-through in duplex documents or lighten the base color. It is recommended that you normally select this setting.

►►► Important

- **Reduce Show-through** can be set when **Recommended** is selected on the **Color Settings** tab of the **Preferences** dialog box and **Document** or **Magazine** is selected for **Image Adjustment**.

Unsharp Mask

Emphasizes the outline of the subjects to sharpen the image when scanning photos.

OFF

Unsharp Mask will not be applied.

ON

Emphasizes the outline of the subjects to sharpen the image. It is recommended that you normally select this setting.

Descreen

Printed photos and pictures are displayed as a collection of fine dots. "Moire" is a phenomenon where uneven gradation or a stripe pattern appears when such photos or pictures printed with fine dots are scanned. **Descreen** is the function for reducing this moire effect.

OFF

Moire will not be reduced.

ON

Reduces moire. It is recommended that you normally select this setting.

►►► Note

- Even if **Descreen** is set to **ON**, some moire effects may remain if **Unsharp Mask** is set to **ON**. In that case, set **Unsharp Mask** to **OFF**.

Reduce Dust and Scratches

Scanned photos may contain white dots caused by dust or scratches. Use this function to reduce such noise.

None

Dust and scratches will not be reduced.

Low

Select this to reduce small dust particles and scratches. Large ones may remain.

Medium

It is recommended that you normally select this setting.

High

Select this to reduce large dust particles and scratches; however, evidence of the reduction process may remain or delicate parts of the image may be removed.

►►► Important

- This function may not be effective for some types of photos.

►►► Note

- It is recommended that you select **None** when scanning printed materials.

Fading Correction

Corrects photos that have faded with time or have a colorcast. "Colorcast" is a phenomenon where a specific color affects the entire picture due to the weather or ambient strong colors.

None

Fading Correction will not be applied.

Low

Select this to correct a small amount of fading and colorcast.

Medium

It is recommended that you normally select this setting.

High

Select this to correct a large amount of fading and colorcast. This can affect the tone of the image.

►►► Important

- You can set **Fading Correction** after preview.
- You can set this setting when **Recommended** is selected on the **Color Settings** tab of the **Preferences** dialog box.
- Correction may not be applied properly if the scan area is too small.

Grain Correction

Use this function to reduce graininess (roughness) in photos taken with high-speed or sensitized film.

None

Graininess will not be reduced.

Low

Select this when the photo is slightly grainy.

Medium

It is recommended that you normally select this setting.

High

Select this when the photo is very grainy. This can affect the gradation and sharpness of the image.

»» Important

- Correction may not be applied properly if the scan area is too small.

Gutter Shadow Correction

Corrects shadows that appear between pages when scanning open booklets.

When you set the **Gutter Shadow Correction** setting in the preview image, the result will be reflected. Preview the effects before scanning, as results vary depending on the type of document and how it is pressed.

Unclear or blurred text/lines caused by curved pages are not corrected.

None

Gutter shadow will not be corrected.

Low

Select this when the effect level is too strong with the medium setting.

Medium

It is recommended that you normally select this setting.

High

Select this when the effect level is too weak with the medium setting.

»» Important

- You can set **Gutter Shadow Correction** after preview.
- Do not place objects that weigh 4.4 lbs (2.0 kg) or more on the platen. Also, do not press on the document with a force exceeding 4.4 lbs (2.0 kg). If you press heavily, the scanner may not work correctly or you might break the glass.
- Align the document with the edge of the Platen. If not, the shadow will not be corrected properly.



- Shadows may not be corrected properly depending on the document. If the page background is not white, shadows may not be detected correctly or may not be detected at all.
- While scanning, press down on the spine with the same amount of pressure you used to preview the scan. If the binding part is not even, the shadow will not be corrected properly.

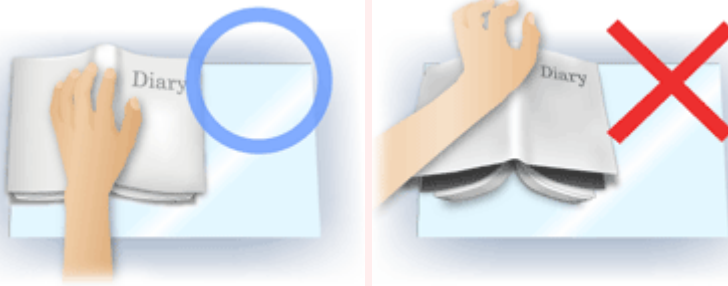

- How to place the document depends on your model and the document to be scanned.

►► Note

- Cover the document with black cloth if white spots, streaks, or colored patterns appear in scan results due to ambient light entering between the document and the Platen.
- If the shadow is not corrected properly, adjust the cropping frame (scan area) on the preview image.
 - ➔ [Adjusting Cropping Frames \(ScanGear\)](#)

Color Adjustment Buttons

The Color Adjustment Buttons allow you to make fine corrections to the image brightness and color tones including adjustments to the image's overall brightness or contrast and adjustments to its highlight and shadow values (histogram) or balance (tone curve).

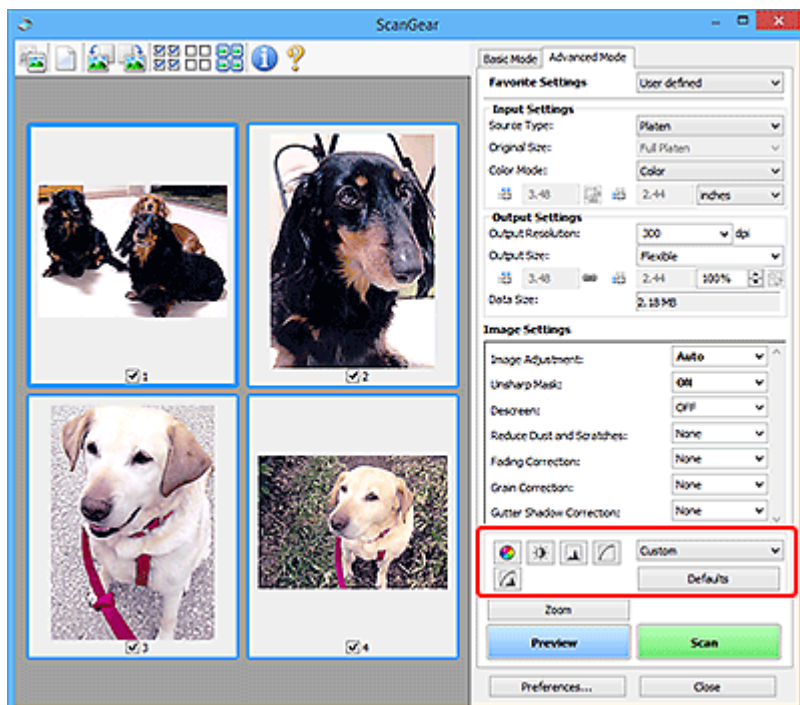

►►► Important

- The Color Adjustment Buttons are not available when you select **Color Matching** on the **Color Settings** tab of the **Preferences** dialog box.

►►► Note

- Selectable settings depend on **Color Mode** settings.
- When you adjust the image via the Color Adjustment Buttons, the results will be reflected in the preview image.

Click a Color Adjustment Button to set the following items:



(Saturation/Color Balance)

Adjust the saturation (vividness) and color tone of the image. Use this function to brighten colors that have faded with time or due to colorcast. "Colorcast" is a phenomenon where a specific color affects the entire picture due to the weather or ambient strong colors.

➔ [Adjusting Saturation and Color Balance](#)



(Brightness/Contrast)

Adjust the brightness and contrast of the image. If the image is too dark or too bright, or if the image quality is flat due to lack of contrast, you can adjust the levels of brightness and contrast.

➔ [Adjusting Brightness and Contrast](#)



(Histogram)

A histogram allows you to see the data concentration at each brightness level of an image. You can specify the brightest level (highlight) and darkest level (shadow) within an image, cut the levels and expand the middle of the tonal range of the image.

➔ [Adjusting Histogram](#)



(Tone Curve Settings)

Adjust the brightness of an image by selecting the type of graph (tone curve) showing the balance of tone input and output. You can make fine adjustments to the brightness of a specific area.

➔ [Adjusting Tone Curve](#)



(Final Review)

Make a final check of color adjustments. The final synthesized tone curve and the histogram derived from the subsequent image processing will be displayed. There are no settings to make in this screen.

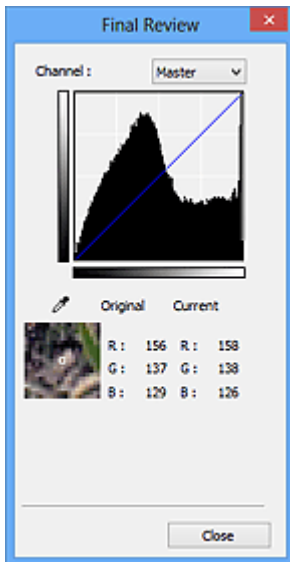

- For a color image, select a color in **Channel** to check either **Red**, **Green**, or **Blue**, or select **Master** to check three colors together.
- If you place the cursor on the preview image, the portion will be enlarged and its RGB values (only L when **Color Mode** is **Grayscale**) before and after the adjustments will be displayed.



(Threshold)

Set the boundary (threshold) at which black and white are divided. By adjusting the threshold level, you can sharpen text in a document or reduce show-through in newspapers.

➔ [Setting Threshold](#)

Custom

You can name and save a set of tone curve and threshold settings of the Color Adjustment Buttons.

Select **Add/Delete...** from the pull-down menu; when **Color Mode** is set to anything but **Black and White**, the **Add/Delete Tone Curve Settings** dialog box opens; when **Color Mode** is **Black and White**, the **Add/Delete Threshold Settings** dialog box opens.

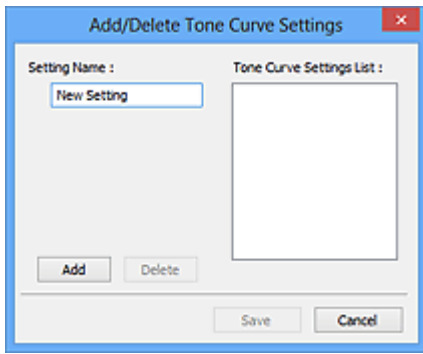

Enter **Setting Name** and click **Add**; the name appears in **Tone Curve Settings List** or **Threshold Settings List**. Click **Save** to save.

To delete an item, select it in **Tone Curve Settings List** or **Threshold Settings List** and click **Delete**. Click **Save** to save the settings displayed in **Tone Curve Settings List** or **Threshold Settings List**.

You can load and apply the saved tone curve/threshold settings to a preview image. To load the settings, select the saved item from the pull-down menu.

»» Note

- Save up to 20 items.

Defaults

Reset all adjustments (saturation/color balance, brightness/contrast, histogram, and tone curve).

Preferences Dialog Box

In the **Preferences** dialog box, you can make advanced settings to ScanGear (scanner driver) functions via the **Scanner**, **Preview**, **Scan**, and **Color Settings** tabs.

Click **Preferences...** in the ScanGear screen to open the **Preferences** dialog box.

►►► Important

- The displayed items vary depending on your model, document type, and view.
- Available functions and settings vary depending on your model.

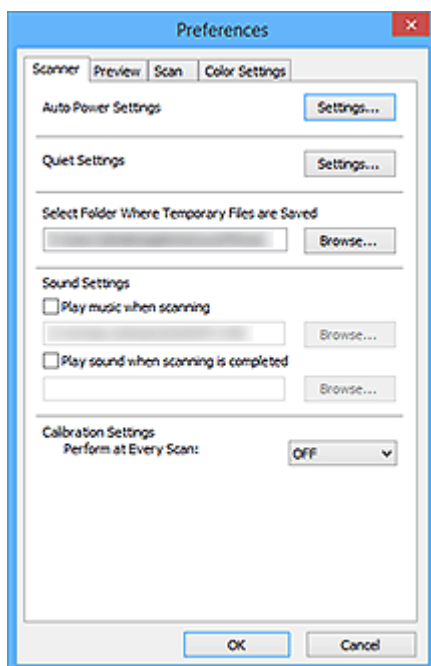

- ➔ [Scanner Tab](#)
- ➔ [Preview Tab](#)
- ➔ [Scan Tab](#)
- ➔ [Color Settings Tab](#)

Scanner Tab

Set the auto power settings and quiet settings, specify the folder in which to save images temporarily, set the music file to play during or at the end of a scan, and more.

Auto Power Settings

You can set to turn the machine on or off automatically.

Click **Settings...** to display the **Auto Power Settings** dialog box.

►►► Note

- If the machine is off or bi-directional communication is disabled, a message may appear because the computer cannot collect the machine status. In that case, click **OK** to exit ScanGear (scanner driver).

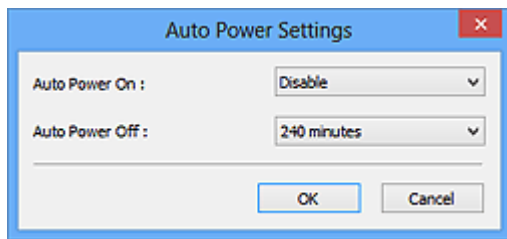

Auto Power On

Select **Enable** to turn on the machine automatically when data is received.

Auto Power Off

Specify the amount of time you want to set from the list. When this time lapses without any data being received, the machine turns off automatically.

»» Important

- When connected to the network, depending on your model, the power does not turn off automatically even if **Auto Power Off** is set.

To check unsupported models, see [List of Unsupported Models \(Auto Power Off\)](#).

Quiet Settings

The silent function allows you to reduce the operating noise of this machine. Use this when you wish to reduce the operating noise such as when scanning or printing at night.

Click **Settings...** to set the quiet mode.

»» Note

- You can set the quiet mode from the operation panel of the machine, the printer driver, or ScanGear.
No matter how the setting is made, it applies to operations from the operation panel of the machine or when printing/scanning from a computer, etc.
- Scanning or printing may take longer than usual when this function is used.

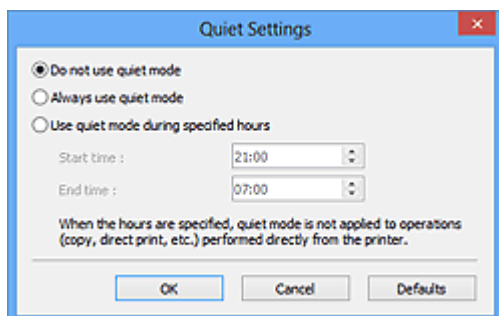

Do not use quiet mode

Select this option when you wish to use the machine with volume of normal operating noise.

Always use quiet mode

Select this option when you wish to reduce the operating noise of the machine.

Use quiet mode during specified hours

Select this option when you wish to reduce the operating noise of the machine during a specified period of time.

Set the **Start time** and **End time** during which quiet mode is to be activated.

»» Important

- The time specified in **Start time** and in **End time** must be different.
- If your scanner or printer does not support fax functions, quiet mode is not applied to operations (copy, direct print, etc.) performed directly from the machine even if the hours are specified.

Select Folder Where Temporary Files are Saved

Displays the folder in which to save images temporarily. To change the folder, click **Browse...** to specify another one.

Sound Settings

You can set the machine to play music during/at the end of a scan.

Select the **Play music when scanning** or **Play sound when scanning is completed** checkbox, then click **Browse...** and specify a sound file.

You can specify the following files.

- MIDI file (*.mid, *.rmi, *.midi)
- Audio file (*.wav, *.aif, *.aiff)
- MP3 file (*.mp3)

Calibration Settings

Platen Calibration

When you click **Start**, calibration starts and the scanner will be adjusted to reproduce correct color tones in scanned images. Perform calibration when the color tones in the preview image are significantly different from the original item or when colors appear in white areas.

Perform at Every Scan

When you set to **ON**, the scanner will be calibrated every time before previewing and scanning, to reproduce correct color tones in scanned images.

»» Note

- Even when **Perform at Every Scan** is set to **OFF**, the scanner may be calibrated automatically in some cases (such as immediately after you turn the machine on).

»» Note

- Calibration may take time depending on your computer.

Test Scanner...

Opens the **Scanner Diagnostics** dialog box from which you can run the scanner performance test. Click **Start** to start the diagnostics.

Preview Tab

Allows you to select what to do with Preview when ScanGear is started, how to display cropping frames after previewing images, and the cropping size for thumbnails of scanned documents.

Preview When ScanGear Starts

Select what to do with Preview when ScanGear (scanner driver) is started.

Automatic preview

ScanGear will automatically start previewing at startup.

Display saved preview image

The previously previewed image will be displayed.

The Color Adjustment Button settings, the Toolbar settings, and the **Advanced Mode** tab settings are also saved.

None

No preview image will be displayed at startup.

▶▶▶ Note

- Select **None** if you do not want to save the preview image.

Cropping Frame on Previewed Images

Select how to display cropping frames after previewing images.

Auto crop previewed images

The cropping frame (scan area) will automatically be displayed in the document size after previewing.

Display the last frame

A cropping frame of the same size as the last used cropping frame will be displayed after previewing.

None

No cropping frame will be displayed after previewing.

Thumbnail Viewing Size

Select the cropping size for thumbnails of scanned documents.

Larger

Displays 105 % (in width and height) of the area displayed for the standard size.

Standard

The standard size.

Smaller

Displays 95 % (in width and height) of the area displayed for the standard size.

▶▶▶ Note

- When you change the **Thumbnail Viewing Size** setting, the preview images will be refreshed and cropped to the new size. As the preview images are refreshed, the color adjustments and other settings applied to them are reset.

Scan Tab

Allows you to select what to do with ScanGear after scanning and set the **Color Mode** (48 bit output) option for **Advanced Mode** tab. Allows you to select what to do with ScanGear after scanning image.

Status of ScanGear dialog after scanning

Select what to do with ScanGear (scanner driver) after scanning images.

Close ScanGear automatically

Select this to return to the original application when scanning is completed.

Do not close ScanGear automatically

Select this to return to the ScanGear screen for another scan when scanning is completed.

Display the dialog to select the next action

Select this to open a screen and select what to do when scanning is completed.

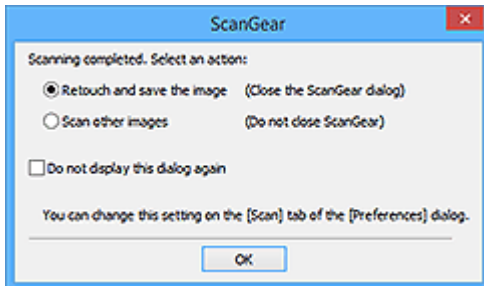

»»» Note

- Even if **Do not close ScanGear automatically** or **Display the dialog to select the next action** is set, some applications may not support it.

Advanced Mode Settings

Enable 48/16 bit output

Select this checkbox to display **Color (48bit)** in **Color Mode** on the **Advanced Mode** tab.

»»» Important

- Some applications cannot receive images scanned in **Color (48bit)** or may close when such images are received.

»»» Note

- When **Color (48bit)** is selected for **Color Mode**, deselecting this checkbox changes **Color (48bit)** to **Color**.
- When using a model supporting 16 bit output, **Grayscale (16bit)** appears in **Color Mode**.

Color Settings Tab

Allows you to select how to adjust color, and specify the monitor gamma value.

Recommended

Select this to vividly reproduce the tone of a document on the screen. It is recommended that you normally select this setting.

Color Matching

Select this to automatically match the scanner, monitor, and color printer colors, thus reducing time and trouble to manually match the monitor and printer colors.

Source (Scanner)

Select scanner profile.

Target

Select target profile.

Monitor

Select this checkbox to display preview image with optimum correction for monitor.

Defaults

Returns to the default **Color Matching** settings.

»» Note

- The Color Adjustment Buttons on the **Advanced Mode** tab are not available when you select **Color Matching**.
- This function is available when **Color Mode** is **Color** or **Color (48bit)**.

None

Select this to disable color correction provided by ScanGear (scanner driver).

»» Note

- Depending on your scanner or printer, this setting may not be available when scanning from the ADF (Auto Document Feeder).
- You can select one when **Color Mode** is **Color**, **Color (48bit)**, or **Grayscale**.
- Color Matching is available when ScanGear, monitor, color management-compliant application (such as Adobe Photoshop), and printer are set up correctly.

Refer to the corresponding manual for the monitor, printer, and application settings.

Monitor Gamma

By setting the gamma value of a monitor, you can adjust the input data to the brightness characteristics of the monitor. Adjust the value if your monitor's gamma value does not match the default value set in ScanGear, and the colors of the original image are not accurately reflected in the monitor.

Click **Defaults** to return to the default Monitor Gamma value (2.20).

»» Note

- Refer to the manual of your monitor to check its gamma value. If it is not written in the manual, contact the manufacturer.

List of Unsupported Models (Auto Power Off)

- ➔ [MG series](#)
- ➔ [MX series](#)
- ➔ [E series](#)

MG series

Model Name	Auto Power Off Function	
	With USB Connection	With Network Connection
MG7500 series	✓	×
MG7100 series	✓	×
MG6700 series	✓	×
MG6600 series	✓	×
MG6500 series	✓	×
MG6400 series	✓	×
MG5600 series	✓	×
MG5500 series	✓	×
MG3500 series	✓	×
MG2900 series	✓	×

MX series

Model Name	Auto Power Off Function	
	With USB Connection	With Network Connection
MX530 series	×	×
MX490 series	✓	×
MX470 series	×	×

E series

Model Name	Auto Power Off Function	
	With USB Connection	With Network Connection
E560 series	✓	×
E480 series	✓	×
E460 series	✓	×

General Notes (Scanner Driver)

ScanGear (scanner driver) is subject to the following restrictions. Keep these points in mind when using it.

Scanner Driver Restrictions

- When using the NTFS file system, the TWAIN data source may not be invoked. This is because the TWAIN module cannot be written to the winnt folder for security reasons. Contact the computer's administrator for help.
- Some computers (including laptops) connected to the machine may not resume correctly from standby mode. In that case, restart the computer.
- Do not connect two or more scanners or multifunction printers with scanner function to the same computer simultaneously. If multiple scanning devices are connected, you cannot scan from the operation panel or scanner buttons of the machine and also may experience errors while accessing the devices.
- Calibration may take time if the machine is connected via USB 1.1.
- Scanning may fail if the computer has resumed from sleep or standby mode. In that case, follow these steps and scan again.

If your model has no power button, perform Step 2 only.

1. Turn off the machine.
2. Exit ScanGear, then disconnect the USB cable from the computer and reconnect it.
3. Turn on the machine.

If scanning still fails, restart the computer.

- ScanGear cannot be opened in multiple applications at the same time. Within an application, ScanGear cannot be opened for the second time when it is already open.
- Be sure to close the ScanGear window before closing the application.
- When using a network compatible model by connecting to a network, the machine cannot be accessed from multiple computers at the same time.
- When using a network compatible model by connecting to a network, scanning takes longer than usual.
- Make sure that you have adequate disk space available when scanning large images at high resolutions. For example, at least 300 MB of free space is required to scan an A4 document at 600 dpi in full-color.
- ScanGear and WIA driver cannot be used at the same time.
- Do not enter the computer into sleep or hibernate state during scanning.

Applications with Restrictions on Use

- Some applications may not display the TWAIN user interface. In that case, refer to the application's manual and change the settings accordingly.
- Some applications do not support continuous scanning of multiple documents. In some cases, only the first scanned image is accepted, or multiple images are scanned as one image. For such applications, do not scan multiple documents from the ADF (Auto Document Feeder).
- To import scanned images into Microsoft Office 2000, first save them using IJ Scan Utility, then import the saved files from the **Insert** menu.

- When scanning Platen size images into Microsoft Office 2003 (Word, Excel, PowerPoint, etc.), click **Custom Insert** in the **Insert Picture from Scanner or Camera** screen. Otherwise, images may not be scanned correctly.
- When scanning images into Microsoft Office 2007/Microsoft Office 2010 (Word, Excel, PowerPoint, etc.), use Microsoft Clip Organizer.
- Images may not be scanned correctly in some applications. In that case, increase the operating system's virtual memory and retry.
- When image size is too large (such as when scanning large images at high resolution), your computer may not respond or the progress bar may remain at 0 % depending on the application. In that case, cancel the action (for example by clicking **Cancel** on the progress bar), then increase the operating system's virtual memory or reduce the image size/resolution and retry. Alternatively, scan the image via IJ Scan Utility first, then save and import it into the application.

Scanning in Advanced Mode

Use the **Advanced Mode** tab to scan by specifying the color mode, output resolution, image brightness, color tone, and other settings.

To scan multiple documents at one time, see [Scanning Multiple Documents at One Time with ScanGear \(Scanner Driver\)](#).

To scan multiple documents placed on the ADF (Auto Document Feeder), see [Scanning Multiple Documents from the ADF \(Auto Document Feeder\) in Advanced Mode](#).

►►► Important

- The following types of documents may not be scanned correctly. In that case, click  (Thumbnail) on the Toolbar to switch to whole image view and scan.
 - Photos with a whitish background
 - Documents printed on white paper, hand-written text, business cards, and other unclear documents
 - Thin documents
 - Thick documents
- The following types of documents cannot be scanned correctly.
 - Documents smaller than 1.2 inches (3 cm) square
 - Photos that have been cut to irregular shapes

1. Place document on Platen, and then start ScanGear (scanner driver).

- ➔ [Positioning Originals \(Scanning from Computer\)](#)
- ➔ [Starting ScanGear \(Scanner Driver\)](#)

2. Click **Advanced Mode** tab.

The tab switches to **Advanced Mode**.

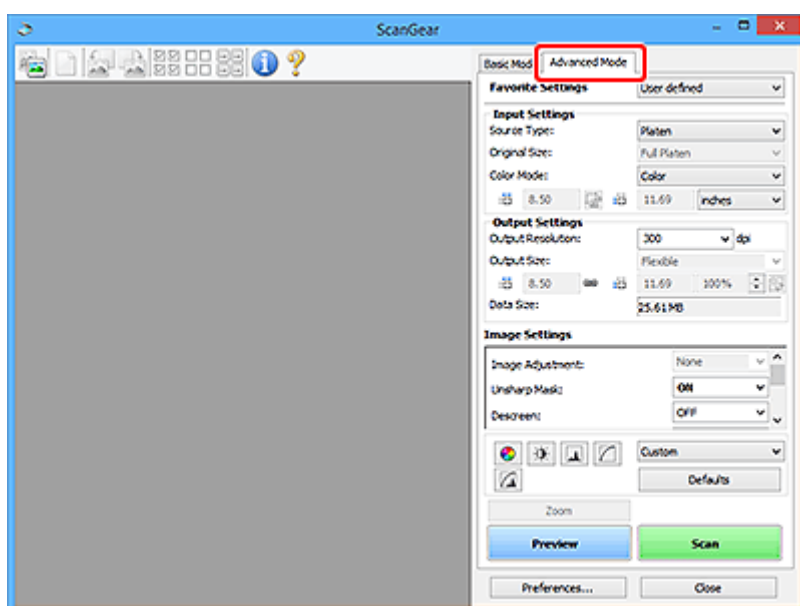

►►► Note

- Settings are not retained when you switch modes.

3. Set [Input Settings](#).

4. Click **Preview**.

Preview images appear in the Preview area.

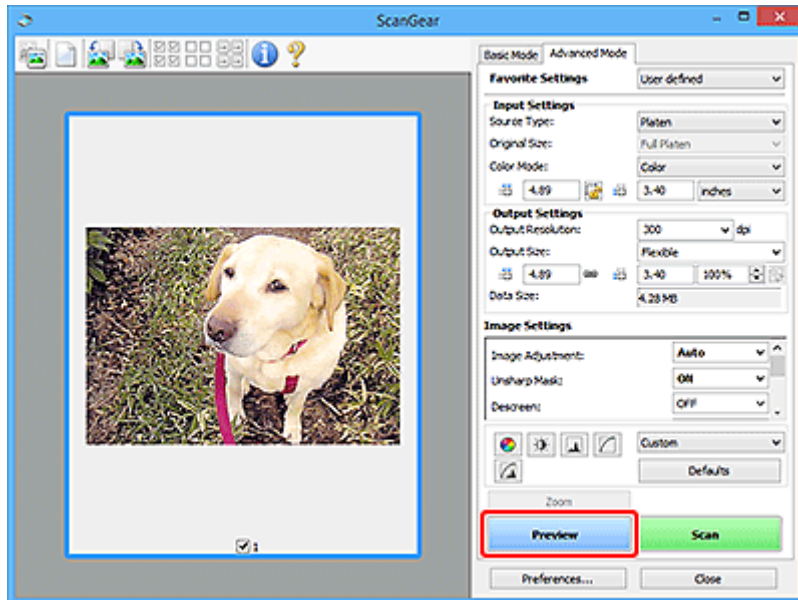

►►► Important

- **Preview** is not available when scanning from the ADF.

5. Set [Output Settings](#).

6. Adjust cropping frame (scan area), correct image, and then adjust colors as needed.

- ➔ [Adjusting Cropping Frames \(ScanGear\)](#)
- ➔ [Image Settings](#)
- ➔ [Color Adjustment Buttons](#)

7. Click **Scan**.

Scanning starts.

►►► Note

- Click  (Information) to display a dialog box showing the document type and other details of the current scan settings.
- How ScanGear behaves after scanning is complete can be set from **Status of ScanGear dialog after scanning** on the [Scan tab](#) of the **Preferences** dialog box.

Related Topic

➔ [Advanced Mode Tab](#)

Scanning Multiple Documents at One Time with ScanGear (Scanner Driver)

You can scan two or more photos (small documents) on the Platen at one time on the **Basic Mode** tab and **Advanced Mode** tab.

This section explains how to scan multiple documents from the **Basic Mode** tab.

▶▶▶ Important

- To scan multiple documents as a single image, scan in whole image view.
- The following types of documents may not be cropped correctly. In that case, adjust the cropping frames (scan areas) in whole image view and scan.
 - Photos with a whitish background
 - Documents printed on white paper, hand-written text, business cards, and other unclear documents
 - Thin documents
 - Thick documents
- ➔ [Scanning Multiple Documents in Whole Image View](#)
- The following types of documents cannot be scanned correctly.
 - Documents smaller than 1.2 inches (3 cm) square
 - Photos that have been cut to various shapes

▶▶▶ Note

- You can also scan multiple documents at one time from the **Advanced Mode** tab. Use the **Advanced Mode** tab to make advanced scan settings such as the color mode, output resolution, image brightness, and color tone.
- Refer to the corresponding sections below for details on the **Basic Mode** tab and **Advanced Mode** tab.
 - ➔ [Basic Mode Tab](#)
 - ➔ [Advanced Mode Tab](#)

1. Place document on Platen, and then start ScanGear (scanner driver).

- ➔ [Positioning Originals \(Scanning from Computer\)](#)
- ➔ [Starting ScanGear \(Scanner Driver\)](#)

2. Set **Select Source** according to the document placed on the Platen.

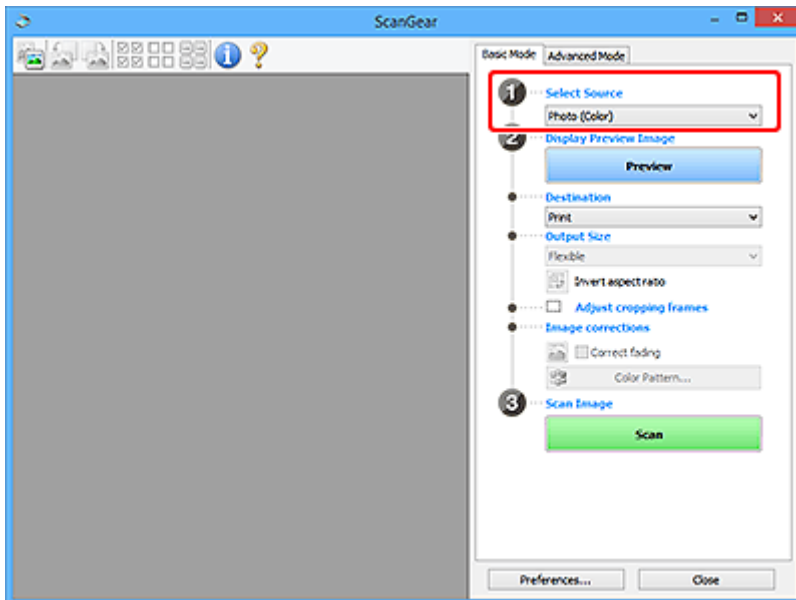

3. Click Preview.

Thumbnails of the preview images appear in the Preview area. Cropping frames are specified automatically according to the document size.

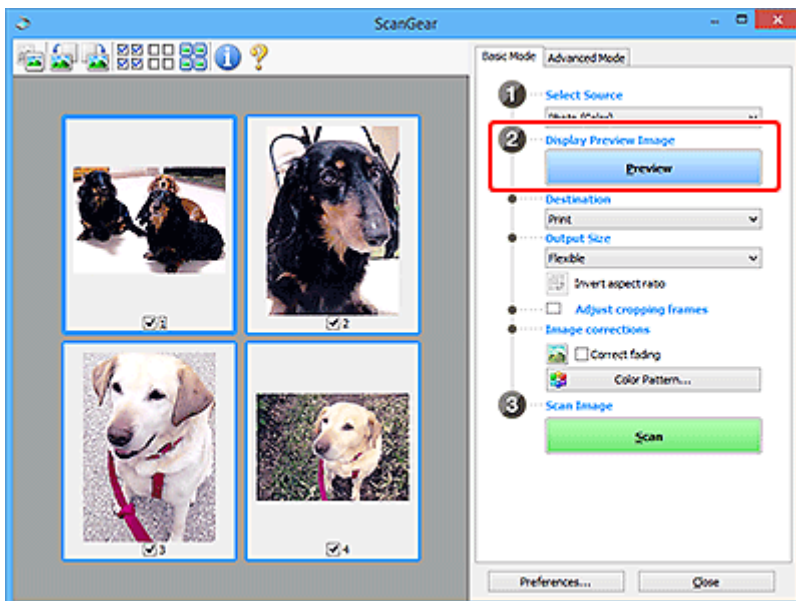

4. Set Destination.

5. Set Output Size according to purpose.

6. Adjust the cropping frames and set Image corrections as required.

▶▶▶ Note

- You can correct each image separately. Select the frame you want to correct.
- In thumbnail view, you can only create one cropping frame per image. To create multiple cropping frames in an image, scan in whole image view.

➔ [Scanning Multiple Documents in Whole Image View](#)

7. Select the images you want to scan.

Select the checkboxes of the images you want to scan.

8. Click **Scan**.

Scanning Multiple Documents in Whole Image View

Follow these steps if thumbnails are not displayed correctly when previewed or if you want to scan multiple documents as a single image.

➤➤➤ Note

- Positions of slanted documents are not corrected in whole image view.

1. After previewing images, click  (Thumbnail) on the Toolbar.

Switch to whole image view.

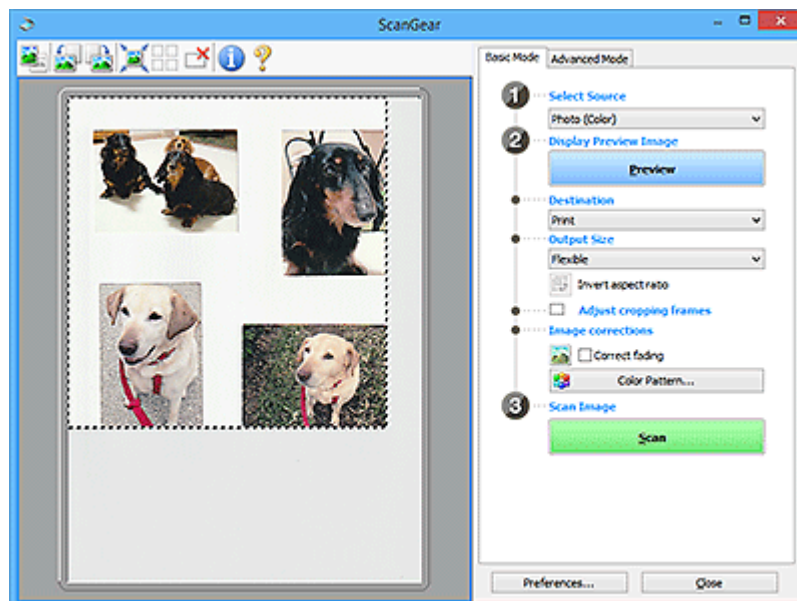

➤➤➤ Note

- When the whole image is displayed, the icon changes to  (Whole Image).

2. Set **Destination**.

3. Set **Output Size** according to purpose.

Invert aspect ratio will be enabled when **Output Size** is set to anything but **Flexible**. Click this button to rotate the cropping frame. Click again to return it to the original orientation.

4. Adjust the cropping frames.

Adjust the size and position of the cropping frames on the preview image. You can also create two or more cropping frames.

If an area is not specified, the document will be scanned at the document size (Auto Crop). If an area is specified, only the portion in the specified area will be scanned.

➔ [Adjusting Cropping Frames \(ScanGear\)](#)

5. Set Image corrections as needed.

6. Click Scan.

Areas framed by broken lines are scanned.

▶▶▶ Note

- How ScanGear behaves after scanning is complete can be set from **Status of ScanGear dialog after scanning** on the [Scan tab](#) of the **Preferences** dialog box.

Correcting Images and Adjusting Colors with ScanGear (Scanner Driver)

- **Correcting Images (Unsharp Mask, Reduce Dust and Scratches, Fading Correction, etc.)**
- **Adjusting Colors Using a Color Pattern**
- **Adjusting Saturation and Color Balance**
- **Adjusting Brightness and Contrast**
- **Adjusting Histogram**
- **Adjusting Tone Curve**
- **Setting Threshold**

Correcting Images (Unsharp Mask, Reduce Dust and Scratches, Fading Correction, etc.)

The **Image Settings** functions on the **Advanced Mode** tab of ScanGear (scanner driver) allow you to enhance the outline of the subjects, reduce dust/scratches, and correct faded colors when scanning images.

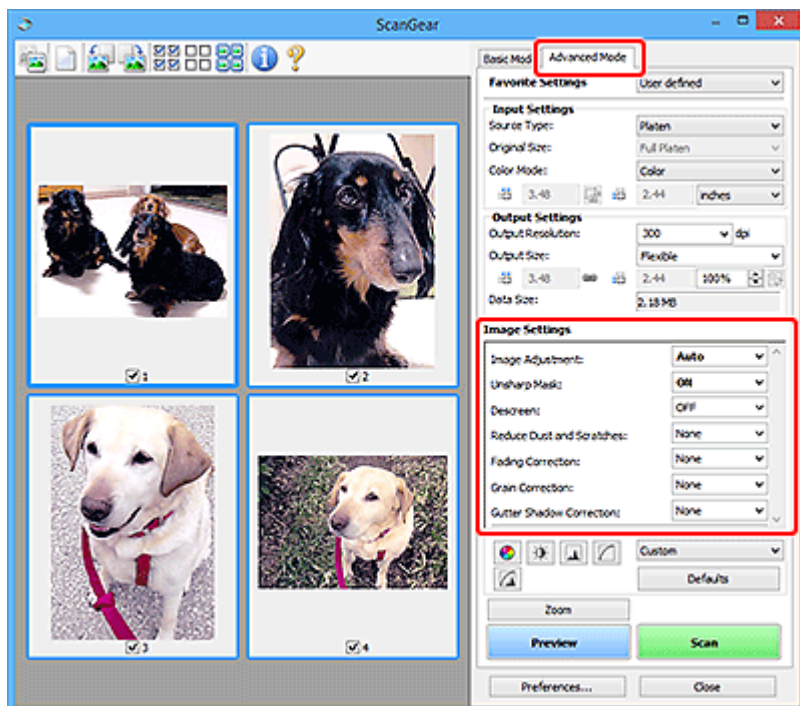

Setting Items

Click  (Arrow) of a function and select an item from the pull-down menu.

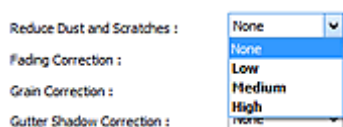

Important

- Do not apply these functions to images without moire, dust/scratches, or faded colors. The color tone may be adversely affected.
- Refer to "[Image Settings](#)" for details and precautions on each function.

Note

- Refer to "[Scanning in Advanced Mode](#)" to start the **Advanced Mode** tab of ScanGear and scan.

Adjusting the image brightness and color tone

Set **Image Adjustment** to **Auto**, **Photo**, **Magazine**, or **Document** according to the document type.

None	Auto
------	------



Reducing show-through in text documents or lightening the base color in recycled paper, newspapers, etc. when scanning documents

Set **Reduce Show-through** to **ON**.

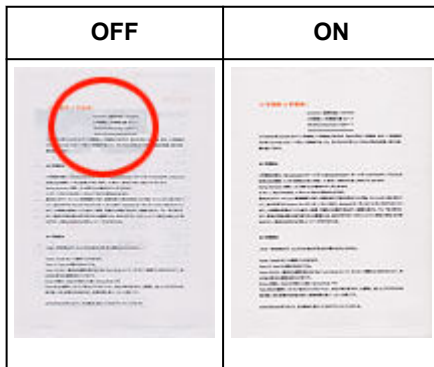

Sharpening slightly out-of-focus images

Set **Unsharp Mask** to **ON**.

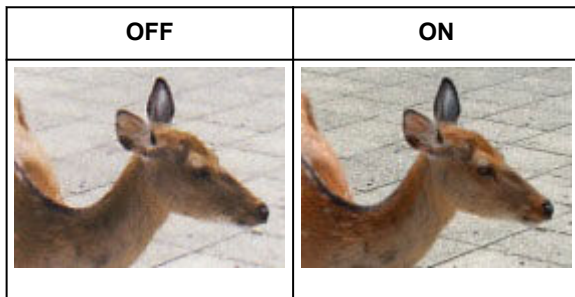

Reducing gradations and stripe patterns

Set **Descreen** to **ON**.



►► Note

- Printed photos and pictures are displayed as a collection of fine dots. "Moire" is a phenomenon where uneven gradation or a stripe pattern appears when such photos or pictures printed with fine dots are scanned. **Descreen** is the function for reducing this moire effect.

Reducing dust and scratches

Set **Reduce Dust and Scratches** to **Low**, **Medium**, or **High** according to the degree of dust and scratches.

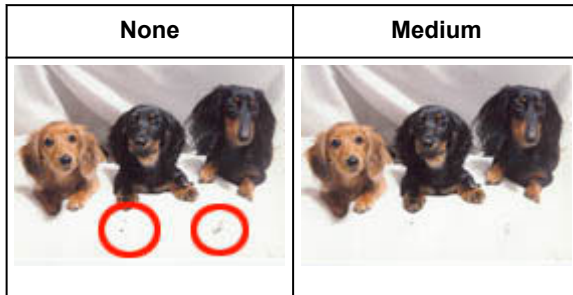

Correcting photos that have faded with time or due to colorcast

Set **Fading Correction** to **Low**, **Medium**, or **High** according to the degree of fading or colorcast.

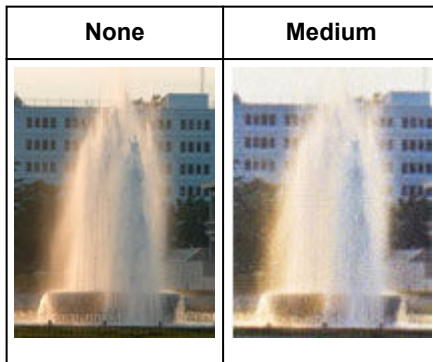

Reducing graininess

Set **Grain Correction** to **Low**, **Medium**, or **High** according to the degree of graininess.

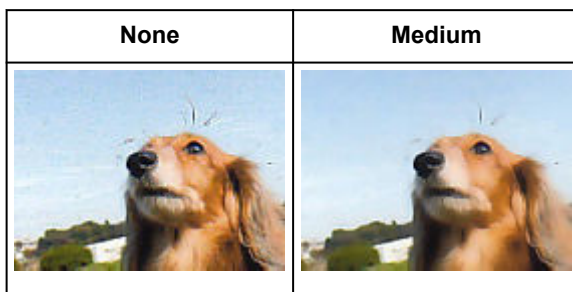

Correcting shadows that appear between pages when scanning open booklets

Set **Gutter Shadow Correction** to **Low**, **Medium**, or **High** according to the degree of shadows.

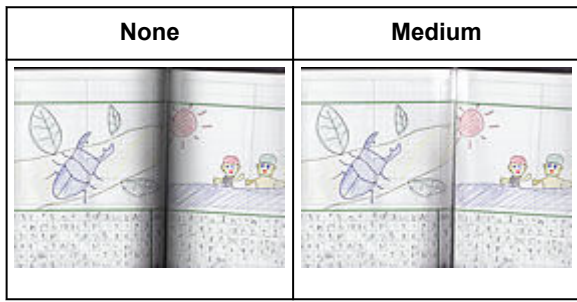

Adjusting Colors Using a Color Pattern

You can preview color changes and reproduce natural colors by using the color pattern function in ScanGear (scanner driver)'s **Basic Mode** tab.

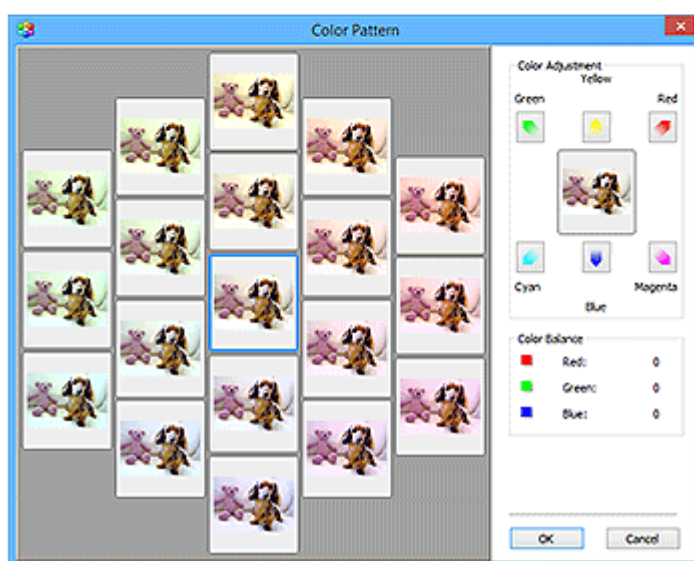
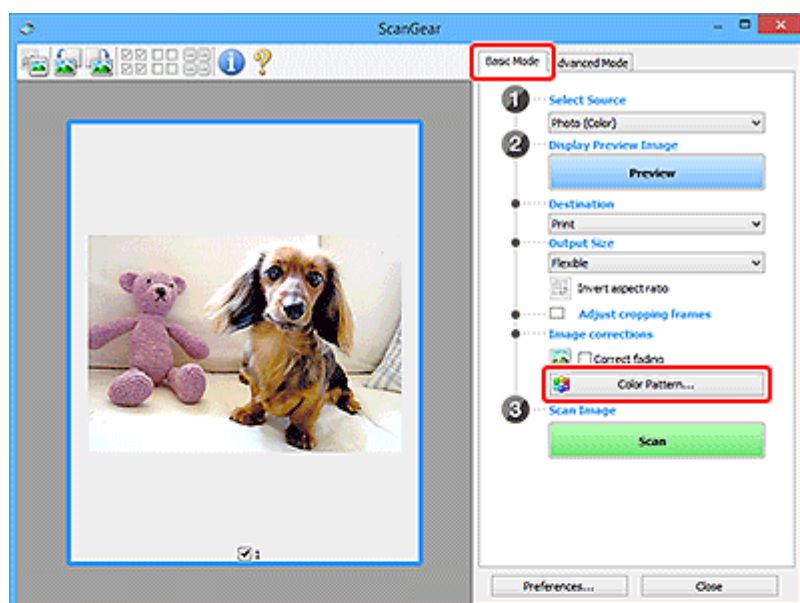

Color Adjustment

Correct colors that have faded with time or due to colorcast. "Colorcast" is a phenomenon where a specific color affects the entire picture due to the weather or ambient strong colors.

Click an arrow in **Color Adjustment** to emphasize the corresponding color.

Cyan & red, magenta & green, and yellow & blue are complementary color pairs (each pair produces a shade of gray when mixed). You can reproduce the natural colors of the scene by reducing the cast color and increasing the complementary color.

It is recommended that you find a portion in the image where it should be white, and adjust the colors so that the portion turns white.

Preview image appears in the center. Preview image colors change as you adjust them.

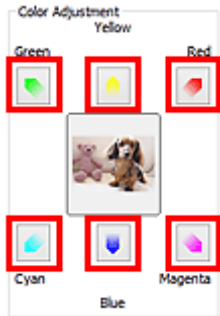

Below is an example of correcting a bluish image.

Since **Blue** and **Green** are too strong, click the **Yellow** and **Magenta** arrows to correct.



»» Note

- Color adjustments are applied only to the cropping frames (scan areas) or the frame selected in thumbnail view.
- You can select multiple frames or cropping frames by clicking them while pressing the Ctrl key.
- You can also select a color tone from the color pattern displayed on the left of the **Color Pattern** screen.
- You can also use this function to add a specific tint to an image. Increase the magenta to add a warm tint, and increase the blue to add a cool tint.

Adjusting Saturation and Color Balance

You can brighten colors that have faded with time or due to colorcast by using  (Saturation/Color Balance) in ScanGear (scanner driver)'s **Advanced Mode** tab.

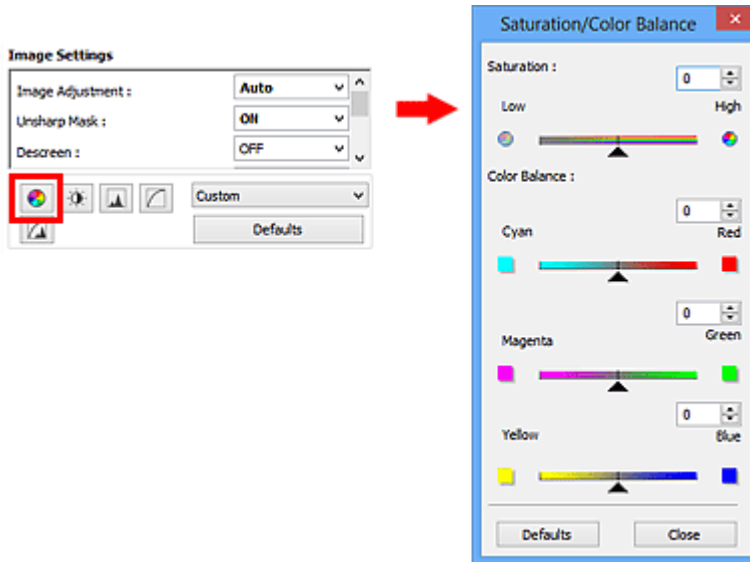

▶▶▶ Note

- Click **Defaults** to reset all adjustments in the current window.

Saturation

Adjust the image's saturation (vividness). You can brighten colors that have faded with time, etc.

Move ▲ (Slider) under **Saturation** to the left to decrease the saturation (darken the image), and to the right to increase the saturation (brighten the image). You can also enter a value (-127 to 127).



Saturation decreased	Original image	Saturation increased
		

▶▶▶ Note

- The natural color tone of the original image may be lost if you increase saturation too much.

Color Balance

Adjust images that have a colorcast. "Colorcast" is a phenomenon where a specific color affects the entire picture due to the weather or ambient strong colors.

Move ▲ (Slider) under **Color Balance** to the left or right to emphasize the corresponding color.

Cyan & Red

Magenta & Green

Yellow & Blue

These are complementary color pairs (each pair produces a shade of gray when mixed). You can reproduce the natural colors of the scene by reducing the cast color and increasing the complementary color.

It is usually difficult to correct the image completely by adjusting only one color pair. It is recommended that you find a portion in the image where it should be white, and adjust all three color pairs so that the portion turns white.

You can also enter a value (-127 to 127).

Below is an example of an image in which the "Cyan & Red" pair has been adjusted.

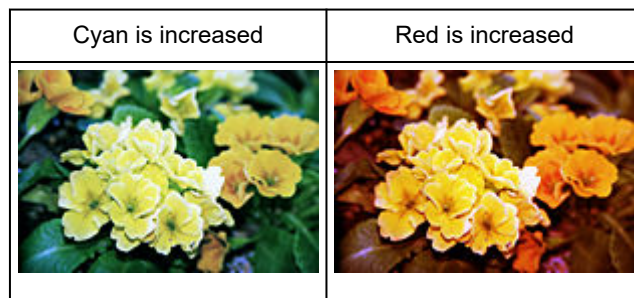

Adjusting Brightness and Contrast

You can adjust images that are too dark or bright, or too flat due to lack of contrast by using  (Brightness/Contrast) in ScanGear (scanner driver)'s **Advanced Mode** tab.

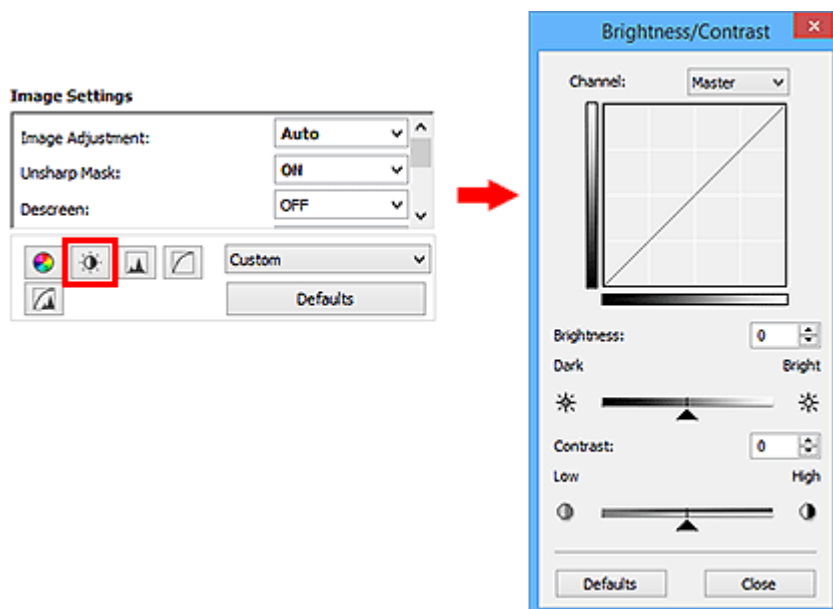

►►► Note

- Click **Defaults** to reset all adjustments in the current window.

Channel

Each dot of an image is a mixture of Red, Green, and Blue in various proportions (gradation). These colors can be adjusted individually as a "channel."

Master

Adjust the Red, Green, and Blue combined.

Red

Adjust the Red channel.

Green

Adjust the Green channel.

Blue

Adjust the Blue channel.

►►► Note

- Only **Grayscale** will be displayed in **Channel** when **Color Mode** is **Grayscale**.

Brightness

Adjust the image brightness.

Move ▲ (Slider) under **Brightness** to the left to darken and right to brighten the image. You can also enter a value (-127 to 127).



Darkened	Original image	Brightened
		

►►► Note

- Highlights may be lost if you brighten the image too much, and shadows may be lost if you darken the image too much.

Contrast

"Contrast" is the degree of difference between the brighter and darker parts of an image. Increasing contrast will increase the difference, thus sharpening the image. Decreasing contrast will decrease the difference, thus softening the image.

Move ▲ (Slider) under **Contrast** to the left to decrease and right to increase the contrast of the image. You can also enter a value (-127 to 127).



Decreased contrast	Original image	Increased contrast
		

►►► Note

- Increasing the contrast is effective in adding a three-dimensional feel to soft images. However, shadows and highlights may be lost if you increase the contrast too much.

Adjusting Histogram

You can adjust the image color tone by using a graph (histogram) showing brightness distribution, via (Histogram) in ScanGear (scanner driver)'s **Advanced Mode** tab.

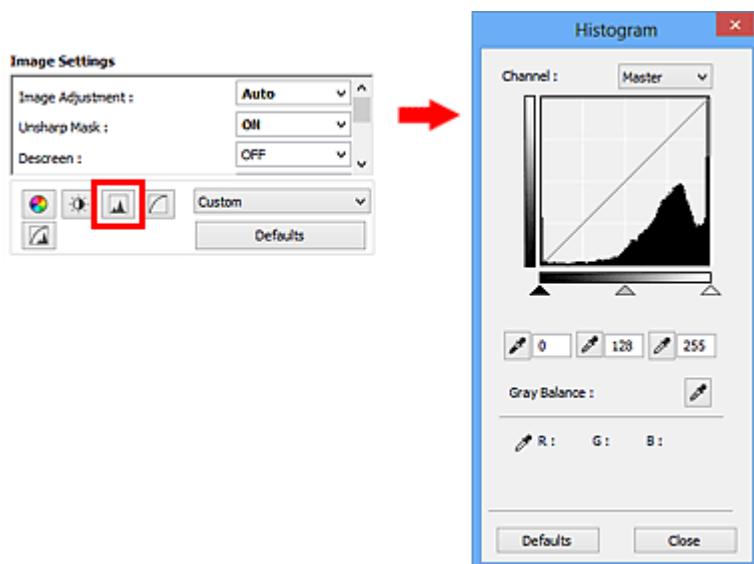

Note

- Click **Defaults** to reset all adjustments in the current window.

Channel

Each dot of an image is a mixture of Red, Green, and Blue in various proportions (gradation). These colors can be adjusted individually as a "channel."

Master

Adjust the Red, Green, and Blue combined.

Red

Adjust the Red channel.

Green

Adjust the Green channel.

Blue

Adjust the Blue channel.

Note

- Only **Grayscale** will be displayed in **Channel** when **Color Mode** is **Grayscale**.

Reading Histograms

You can see the histogram of a specified area for each **Channel**. The higher the histogram peak, the more data is distributed to that level.

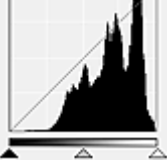
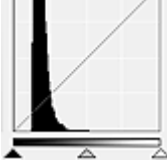
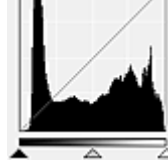

(1) Bright area	(2) Dark area	(3) Whole image
		
More data is distributed to the high-light side.	More data is distributed to the shadow side.	Data is widely distributed between the highlight and shadow.

Adjusting Histograms (Using the Slider)

Select a **Channel**, then move ▲ (Black-point Slider) or △ (White-point Slider) to specify the level to be set as the shadow or highlight.

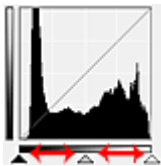

- All parts to the left of ▲ (Black-point Slider) will be black (level 0).
- The parts at △ (Mid-point Slider) will turn to the color exactly between the black-point and white-point.
- All parts to the right of △ (White-point Slider) will turn white (level 255).

When **Image Adjustment** is set to anything but **None**, the adjustments shown below are performed automatically.

Moving the Black-point and White-point Sliders

Move the Black-point Slider or White-point Slider to adjust brightness.

Images with more data distributed to the highlight side

Move the Black-point Slider toward the highlight side.

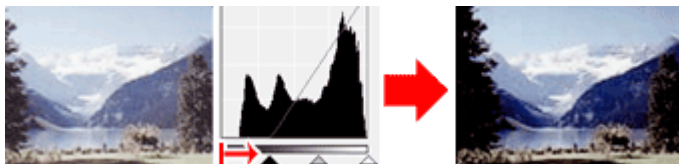

Images with more data distributed to the shadow side

Move the White-point Slider toward the shadow side.

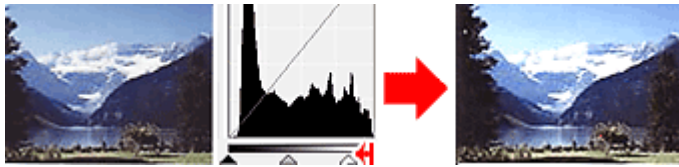

Images with widely distributed data

Move the Black-point Slider toward the highlight side, and White-point Slider toward the shadow side.

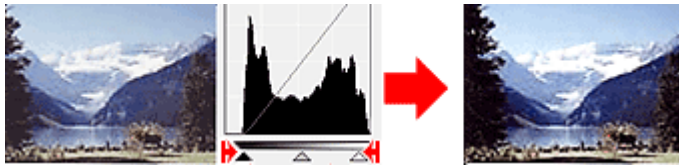

Moving the Mid-point Slider

Move the Mid-point Slider to specify the level to be set as the middle of the tonal range.

Images with more data distributed to the highlight side

Move the Mid-point Slider toward the highlight side.

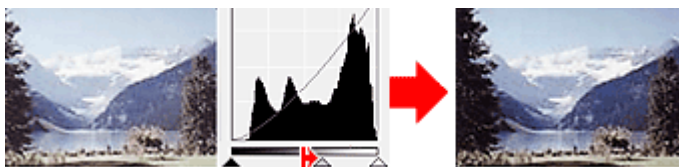

Images with more data distributed to the shadow side





Move the Mid-point Slider toward the shadow side.

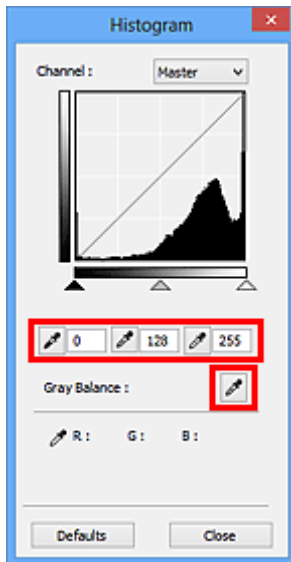

Adjusting Histograms (Using the Droppers)

When you select a **Channel** and click the Black-point, Mid-point, or White-point Dropper, the mouse pointer on the preview image changes to a dropper. Click a Dropper displayed below the histogram to change the setting.



- The point clicked with  (Black-point Dropper) will be the darkest point. You can also enter a value (0 to 245).
- The point clicked with  (Mid-point Dropper) will be the middle of the tonal range. You can also enter a value (5 to 250).
- The point clicked with  (White-point Dropper) will be the brightest point. You can also enter a value (10 to 255).
- Click  (Dropper) for **Gray Balance** and click the area you want to adjust the color in the preview image.

The clicked point will be set as the achromatic color reference, and the rest of the image is adjusted accordingly. For instance, if snow in a photo appears bluish, click the bluish part to adjust the whole image and reproduce natural colors.

Adjusting Tone Curve

You can adjust the brightness of an image by selecting the type of graph (tone curve) showing the balance of tone input and output, via  (Tone Curve Settings) in ScanGear (scanner driver)'s **Advanced Mode** tab.

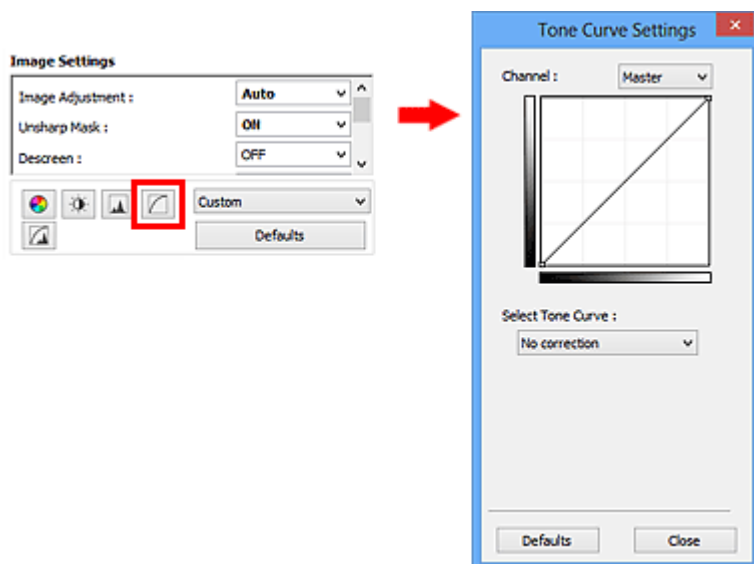

▶▶▶ Note

- Click **Defaults** to reset all adjustments in the current window.

Channel

Each dot of an image is a mixture of Red, Green, and Blue in various proportions (gradation). These colors can be adjusted individually as a "channel."

Master

Adjust the Red, Green, and Blue combined.

Red

Adjust the Red channel.

Green

Adjust the Green channel.

Blue

Adjust the Blue channel.

▶▶▶ Note

- Only **Grayscale** will be displayed in **Channel** when **Color Mode** is **Grayscale**.

Reading Tone Curves

With ScanGear, scanning images via a scanner is the input, and displaying to a monitor is the output. "Tone Curve" shows the balance of tone input and output for each **Channel**.

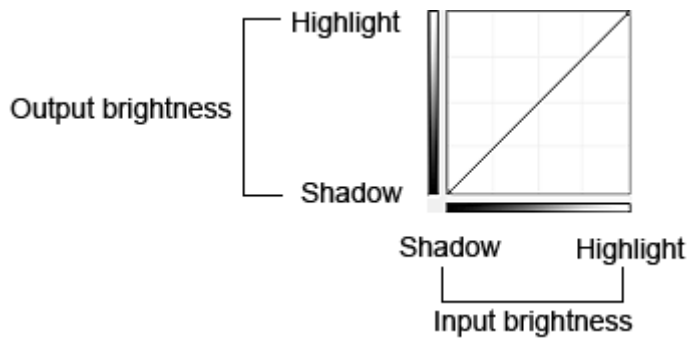

Adjusting Tone Curve

In **Select Tone Curve**, select a tone curve from **No correction**, **Overexposure**, **Underexposure**, **High contrast**, **Reverse the negative/positive image**, and **Edit custom curve**.

No correction (No adjustment)

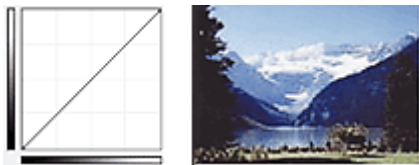

Overexposure (Convex curve)

The midtone data of the input side is stretched toward the highlight of the output side, resulting in a bright-toned image when viewed on a monitor.



Underexposure (Concave curve)

The midtone data of the input side is stretched toward the shadow of the output side, resulting in a dark-toned image when viewed on a monitor.

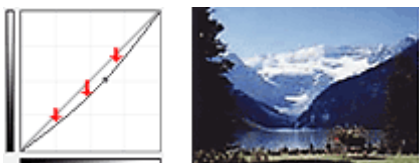

High contrast (S curve)

The highlight and shadow of the input side are enhanced, resulting in a high-contrast image.

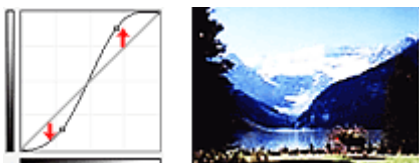

Reverse the negative/positive image (Downward-sloping line)

The input and output sides are reversed, resulting in a negative-positive inverted image.

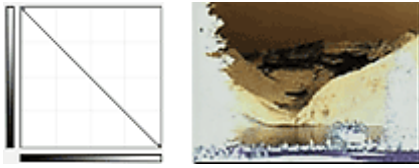

Edit custom curve

You can drag specific points on the Tone Curve to freely adjust the brightness of the corresponding areas.

Setting Threshold

You can sharpen text in a document or reduce show-through in newspapers by adjusting the threshold level via  (Threshold) in ScanGear (scanner driver)'s **Advanced Mode** tab.

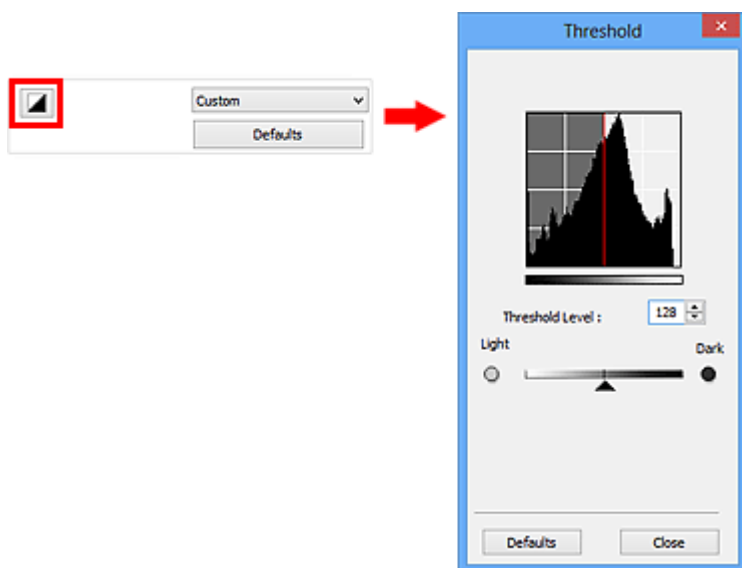

►►► Note

- This function is available when **Color Mode** is **Black and White**.
- Click **Defaults** to reset all adjustments in the current window.

Adjusting Threshold

The brightness of color and grayscale images is expressed in a value between 0 and 255. However, in creating black and white images, all colors are mapped to either black (0) or white (255). "Threshold" is the borderline value that determines a color as black or white.

Move  (Slider) to the right to increase the threshold value and thus increase the black areas. Move the slider to the left to decrease the value and thus increase the white areas. You can also enter a value (0 to 255).



Positioning Originals (Scanning from Computer)

This section describes how to load originals on the platen or ADF (Auto Document Feeder) for scanning. If items are not placed correctly they may not be scanned correctly.

Important

- Be sure to observe the following when loading the original on the platen. Failure to observe the following may cause the scanner to malfunction or the platen glass to break.
 - Do not place any objects weighing 4.4 lb (2.0 kg) or more on the platen glass.
 - Do not put any pressure of 4.4 lb (2.0 kg) or more on the platen glass, such as pressing down the original.
- Close the document cover when scanning.
- Do not touch the operation panel buttons or LCD (Liquid Crystal Display) when opening/closing the document cover. May result in unintended operation.
- When using a personal scanner in the upright position, the item type may not be detected automatically. In that case, specify the item type in IJ Scan Utility or ScanGear (scanner driver) and scan.

➔ [Placing Items \(Platen\)](#)

➔ [Placing Documents \(ADF \(Auto Document Feeder\)\)](#)

➔ [Placing Items \(When Using Stand\)](#)

Placing Items (Platen)

Place items as described below to scan by detecting the item type and size automatically.

Important

- When scanning by specifying the paper size in IJ Scan Utility or ScanGear (scanner driver), align an upper corner of the item with the corner at the arrow (alignment mark) of the platen.
- Photos that have been cut to irregular shapes and items smaller than 1.2 inches (3 cm) square cannot be cropped accurately when scanning.
- Reflective disc labels may not be scanned as expected.

Photos, Postcards, Business Cards, and BD/DVD/CD	Magazines, Newspapers, and Documents
<div data-bbox="220 1568 726 1697" data-label="Image"> </div> <p data-bbox="188 1749 327 1776">Single item:</p> <p data-bbox="188 1798 1091 1899">Place the item face-down on the platen, with 0.4 inch (1 cm) or more space between the edges (diagonally striped area) of the platen and the item. Portions placed on the diagonally striped area cannot be scanned.</p>	<div data-bbox="1157 1563 1380 1639" data-label="Image"> </div> <p data-bbox="1110 1671 1433 1946">Place the item face-down on the platen and align an upper corner of the item with the corner at the arrow (alignment mark) of the platen. Portions placed on the diagonally striped area cannot be scanned.</p>

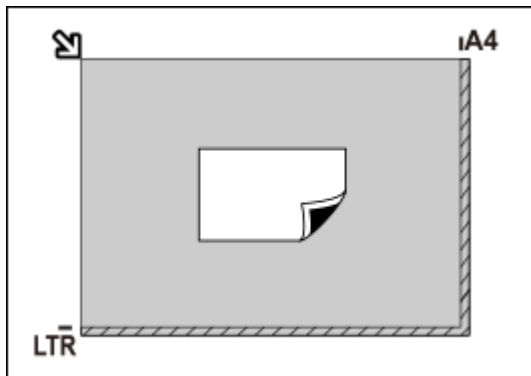

▶▶▶ Important

- Large items (such as A4 size photos) that cannot be placed away from the edges/arrow (alignment mark) of the platen may be saved as PDF files. To save in a format other than PDF, scan by specifying the data format.

Multiple items:

Allow 0.4 inch (1 cm) or more space between the edges (diagonally striped area) of the platen and items, and between items. Portions placed on the diagonally striped area cannot be scanned.

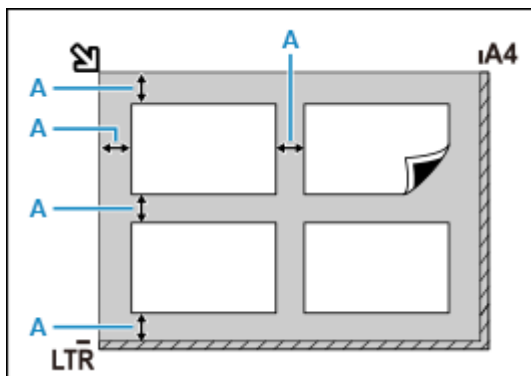

A : 0.4 inch (1 cm) or more

▶▶▶ Note

- Place up to 12 items.
- Place up to four items if the **Compress scanned images upon transfer** checkbox is selected in the Settings dialog box of IJ Scan Utility.
- With network connection, items may not be scanned correctly when five or more items are placed. In that case, reduce the number of items placed on the platen to four or less, and then scan again.
- Positions of slanted items (10 degrees or less) are corrected automatically.

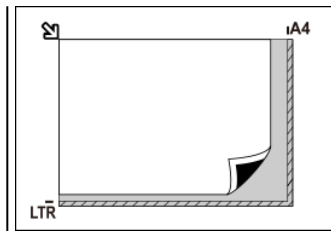

▶▶▶ Important

• Inkjet All-In-One printer:

For the portions in which items cannot be scanned, see Loading Originals.

• Personal scanner:

For the portions in which items cannot be scanned, see Items You Can Place & How to Place Items.

Placing Documents (ADF (Auto Document Feeder))

▶▶▶ Important

- Do not leave thick items on the platen when scanning from the ADF. May result in paper jam.
- Place and align documents of the same size when scanning two or more documents.
- For supported document sizes when scanning from the ADF, see Supported Originals.

1. Make sure any original has been removed from platen.
2. Open document tray (A).

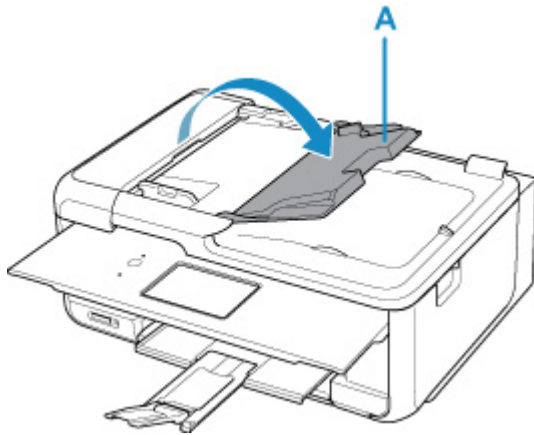

3. Slide the document guide (B) all the way out.

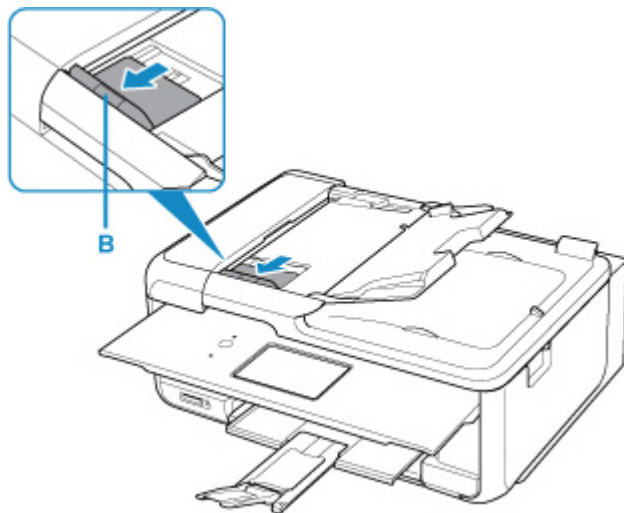

▶▶▶ Note

- The location and number of document guides may vary depending on your model.

4. Load document with side to scan facing up in document tray.

Insert the document until it stops.

5. Adjust document guide to match width of document.

Do not slide the document guide too hard against the document. The document may not be fed properly.

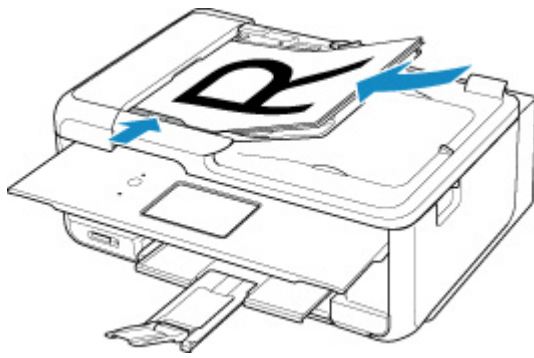

►► Note

- When scanning duplex documents, place the front sides facing up. They will not be scanned correctly if placed the other way around.

Placing Items (When Using Stand)

1. Place item on platen.

1. Open the document cover.
2. Place the item with the side to scan facing the platen, and then align it with the alignment mark.

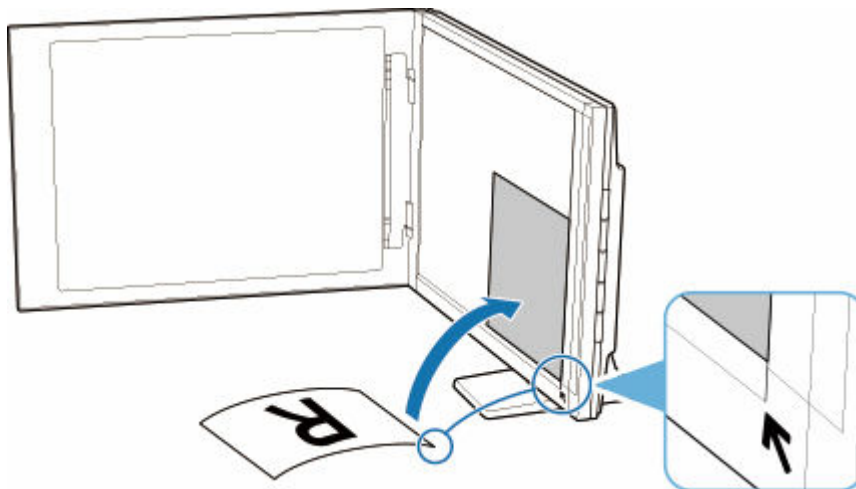

►► Important

- If you open the document cover wide, the scanner may fall over.
- Portions placed over (A) (0.094 inch (2.4 mm) from the left edge of the platen) or (B) (0.106 inch (2.7 mm) from the front edge) cannot be scanned.

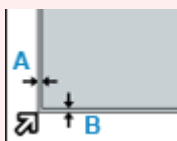

2. Gently close document cover.

While scanning, hold the document cover gently with your hand to keep it closed.

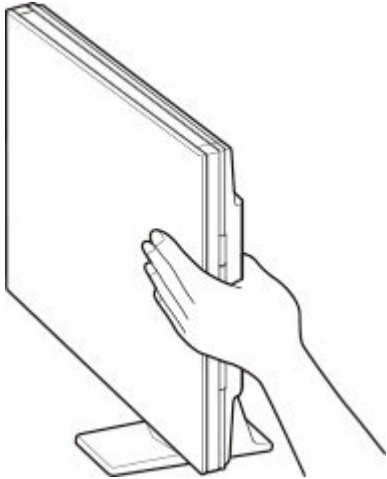

▶▶ Important

- Keep these points in mind when using the scanner in the upright position.
 - Do not subject the scanner to vibration during operation. The correct image results may not be obtained (for example, images may blur).
 - The item type may not be detected automatically. In that case, specify the item type in IJ Scan Utility or ScanGear (scanner driver) and scan.

Adjusting Cropping Frames (ScanGear)

"Cropping" is the act of selecting the area you want to keep in an image and discarding the rest when scanning it.

On the **Basic Mode** tab and **Advanced Mode** tab, you can specify cropping frames (scan areas) on the image(s) displayed in the Preview area of the screen.

When you perform a scan, each area specified with a cropping frame will be scanned as a separate image.

▶▶ Note

- In whole image view, you can specify multiple cropping frames on the preview image.
- For how to adjust cropping frames with IJ Scan Utility, see [Adjusting Cropping Frames in the Image Stitch Window](#).

Initial Cropping Frame

In thumbnail view:

No cropping frame is specified. You can drag the mouse over a thumbnail to specify a cropping frame.

In whole image view:

An active cropping frame is automatically specified around the preview image. You can drag the cropping frame in the Preview area to specify the area.

▶▶ Note

- The auto crop setting can be changed with **Cropping Frame on Previewed Images** on the [Preview tab](#) of the **Preferences** dialog box.

Cropping Frame Types

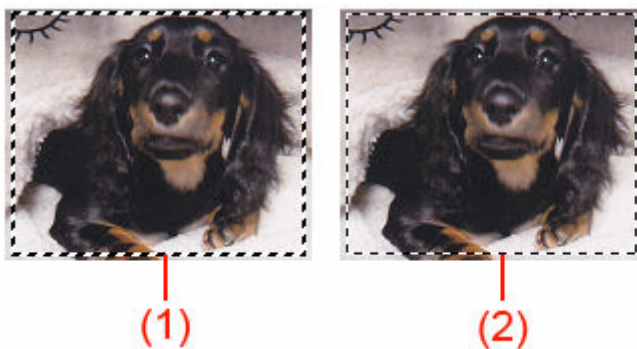

(1) Thick cropping frame (rotating or stationary)

Represents a selected cropping frame. Appears only in whole image view. You can select multiple cropping frames by clicking them while pressing the Ctrl key. Output size, image corrections, and other settings on the **Basic Mode** tab or **Advanced Mode** tab will be applied to all the selected cropping frames.

(2) Thin cropping frame

In thumbnail view:

Output size, image corrections, and other settings on the **Basic Mode** tab or **Advanced Mode** tab will be applied.

In whole image view:

Represents an unselected cropping frame. The settings on the **Basic Mode** tab or **Advanced Mode** tab will not be applied.

Adjusting a Cropping Frame





The cursor will change into  (Arrow) when it is positioned over a cropping frame. If you click and drag the mouse in the direction of the arrow, the cropping frame will expand or contract accordingly.



The cursor will change into  (Crosshair Arrow) when it is positioned within a cropping frame. Click and drag the mouse to move the entire cropping frame.



▶▶ Note

- On the **Advanced Mode** tab, you can specify the cropping frame size by entering the values into  (Width) and  (Height) in [Input Settings](#).
- You can rotate a cropping frame 90 degrees by clicking  (Switch Aspect Ratio). However,  (Switch Aspect Ratio) is not available when **Output Size** is **Flexible**.

Creating Multiple Cropping Frames

In thumbnail view:

You can only create one cropping frame per image.

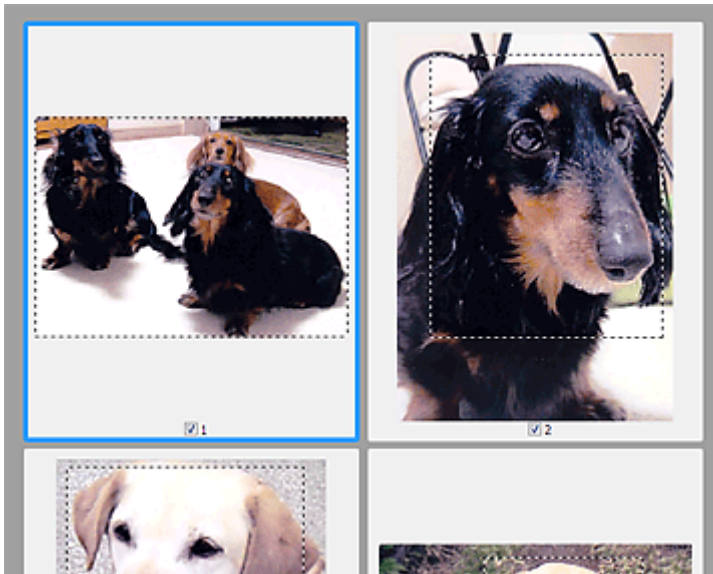

In whole image view:

Click and drag the mouse in a space outside the existing cropping frame to create a new cropping frame in the Preview area. The new cropping frame will be the active cropping frame, and the old cropping frame will be the unselected cropping frame.

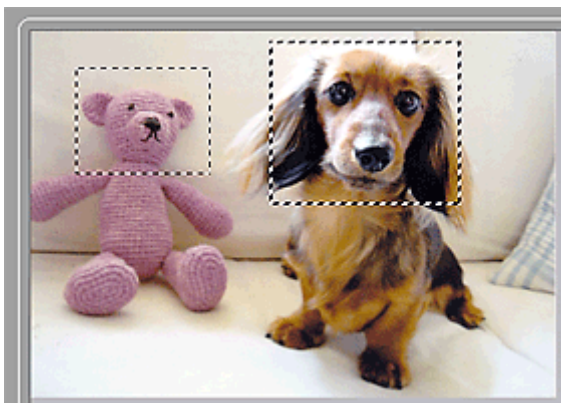

You can create multiple cropping frames and apply different scan settings to each cropping frame.

You can also select multiple cropping frames by clicking them while pressing the Ctrl key.

If you select multiple cropping frames and change the settings on a tab at the right of ScanGear, the settings will be applied to all the selected cropping frames.

When you create a new cropping frame, it retains the settings of the latest cropping frame.

➤➤ Note

- Create up to 12 cropping frames.
- Scanning takes longer than usual when multiple cropping frames are selected.

Deleting Cropping Frames

In thumbnail view:

To delete a cropping frame, click an area outside the cropping frame on an image.

In whole image view:

To delete a cropping frame, select it and click  (Remove Cropping Frame) on the Toolbar. Alternatively, press the Delete key.

When there are multiple cropping frames, all the selected cropping frames (active cropping frame and selected cropping frames) are deleted simultaneously.

Scanning Tips

- ▶ **Positioning Originals (Scanning from Computer)**
- ▶ **Network Scan Settings**
 - IJ Network Scanner Selector EX2 Menu and Setting Screen
- ▶ **Scanning with WIA Driver**
- ▶ **Resolution**
- ▶ **Data Formats**
- ▶ **Color Matching**

Positioning Originals (Scanning from Computer)

This section describes how to load originals on the platen or ADF (Auto Document Feeder) for scanning. If items are not placed correctly they may not be scanned correctly.

Important

- Be sure to observe the following when loading the original on the platen. Failure to observe the following may cause the scanner to malfunction or the platen glass to break.
 - Do not place any objects weighing 4.4 lb (2.0 kg) or more on the platen glass.
 - Do not put any pressure of 4.4 lb (2.0 kg) or more on the platen glass, such as pressing down the original.
- Close the document cover when scanning.
- Do not touch the operation panel buttons or LCD (Liquid Crystal Display) when opening/closing the document cover. May result in unintended operation.

➔ [Placing Items \(Platen\)](#)

➔ [Placing Documents \(ADF \(Auto Document Feeder\)\)](#)

Placing Items (Platen)

Place items as described below to scan by detecting the item type and size automatically.

Important

- Depending on your model, the function to scan by automatically detecting the item type and size does not appear.
- When scanning by specifying the paper size in IJ Scan Utility or ScanGear (scanner driver), align an upper corner of the item with the corner at the arrow (alignment mark) of the platen.
- Photos that have been cut to irregular shapes and items smaller than 1.2 inches (3 cm) square cannot be cropped accurately when scanning.
- Reflective disc labels may not be scanned as expected.
- If scanned by detecting the item type and size automatically, the response may differ. In that case, adjust the cropping frame (scan area) manually.

Photos, Postcards, Business Cards, and BD/DVD/CD	Magazines, Newspapers, and Documents
<div data-bbox="220 1630 724 1733" data-label="Image"> </div> <p data-bbox="188 1787 327 1816">Single item:</p> <p data-bbox="188 1839 1096 1935">Place the item face-down on the platen, with 0.4 inch (1 cm) or more space between the edges (diagonally striped area) of the platen and the item. Portions placed on the diagonally striped area cannot be scanned.</p>	<div data-bbox="1161 1603 1378 1675" data-label="Image"> </div> <p data-bbox="1110 1709 1430 1984">Place the item face-down on the platen and align an upper corner of the item with the corner at the arrow (alignment mark) of the platen. Portions placed on the diagonally striped area cannot be scanned.</p>

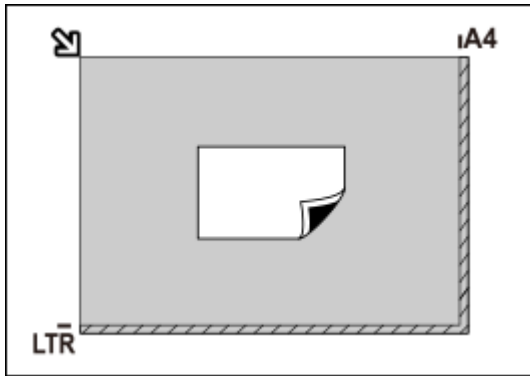

Important

- Large items (such as A4 size photos) that cannot be placed away from the edges/arrow (alignment mark) of the platen may be saved as PDF files. To save in a format other than PDF, scan by specifying the data format.

Multiple items:

Allow 0.4 inch (1 cm) or more space between the edges (diagonally striped area) of the platen and items, and between items. Portions placed on the diagonally striped area cannot be scanned.

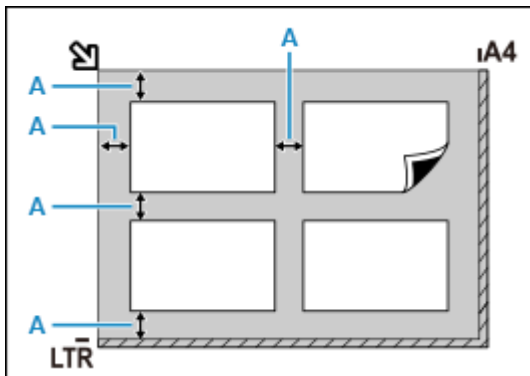

A : 0.4 inch (1 cm) or more

Note

- Place up to 12 items.
- Positions of slanted items (10 degrees or less) are corrected automatically.

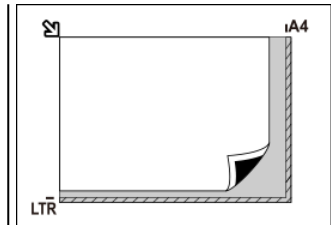

Important

- For the portions in which items cannot be scanned, see Loading Originals.

Placing Documents (ADF (Auto Document Feeder))

Important

- Be careful not to let anything get inside the document output slot. It may cause damage.
- Place and align documents of the same size when scanning two or more documents.
- For supported document sizes when scanning from the ADF, see Supported Originals.

Note

- To scan a document at optimum quality, load it on the platen.

1. Make sure any original has been removed from platen.

2. Open document tray (A).

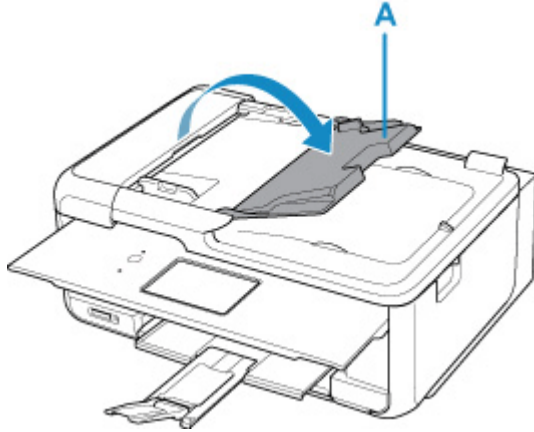

3. Slide the document guide (B) all the way out.

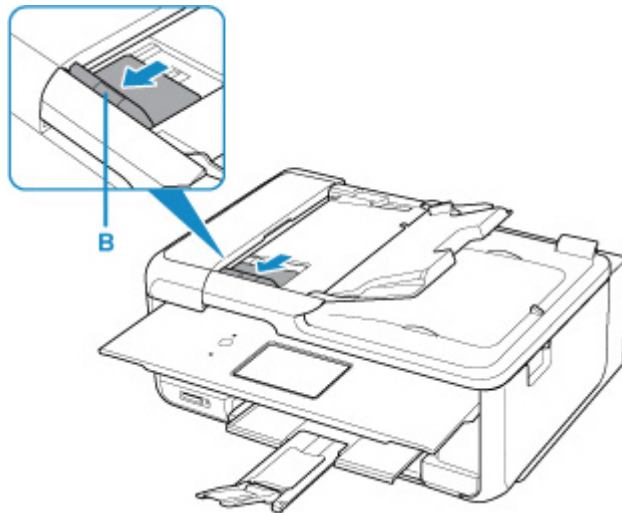

▶▶▶ Note

- The location and number of document guides may vary depending on your model.

4. Load document with side to scan facing up in document tray.

Insert the document until it stops.

5. Adjust document guide to match width of document.

Do not slide the document guide too hard against the document. The document may not be fed properly.

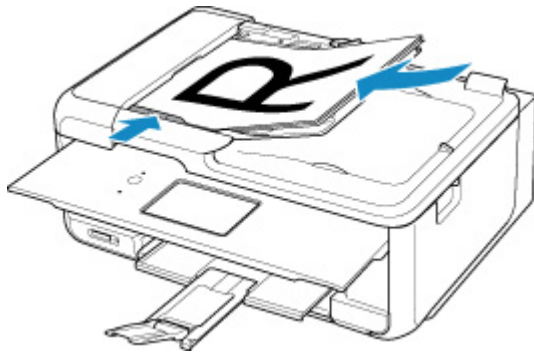

»» Note

- When scanning duplex documents, place the front sides facing up. They will not be scanned correctly if placed the other way around.

Network Scan Settings

You can connect your scanner or printer to a network to share it among multiple computers or scan images into a specified computer.

▶▶▶ Important

- Multiple users cannot scan at the same time.

▶▶▶ Note

- Complete the network settings of your scanner or printer beforehand by following the instructions on our website.
- With network connection, scanning takes longer than USB connection.

Complete the following settings to enable scanning over a network.

Specifying Your Scanner or Printer

Use IJ Network Scanner Selector EX to specify the scanner you want to use. By specifying the scanner, you can scan over a network from your computer or the operation panel.

▶▶▶ Important



- If the product you want to use is changed with IJ Network Scanner Selector EX, the product used for scanning with IJ Scan Utility changes as well. The product for scanning from the operation panel also changes.

If your scanner or printer is not selected in IJ Scan Utility, check that it is selected with IJ Network Scanner Selector EX.

Refer to "[IJ Network Scanner Selector EX2 Menu and Setting Screen](#)" for details.

- To scan from the operation panel, specify your scanner or printer with IJ Network Scanner Selector EX beforehand.

1. Check that IJ Network Scanner Selector EX is running.

If IJ Network Scanner Selector EX is running,  (IJ Network Scanner Selector EX2) appears in the notification area on the desktop. Click  to check the hidden icons as well.

▶▶▶ Note

- If the icon is not displayed in the notification area on the desktop, follow the procedure below to start.

- **Windows 11/Windows 10:**

From the **Start** menu, click **(All apps >) Canon Utilities > IJ Network Scanner Selector EX2**.

- **Windows 8.1:**

Click **IJ Network Scanner Selector EX2** on the Start screen.

If **IJ Network Scanner Selector EX2** is not displayed on the Start screen, select the **Search** charm, then search for "IJ Network Scanner Selector EX2".

– **Windows 7:**

From the **Start** menu, click **All Programs > Canon Utilities > IJ Network Scanner Selector EX2 > IJ Network Scanner Selector EX2**.

The icon appears in the notification area on the desktop, and the Scan-from-PC Settings screen appears. In that case, skip ahead to Step 3.

2. In the notification area on the desktop, right-click  (IJ Network Scanner Selector EX2), then select **Settings...**

The Scan-from-PC Settings screen appears.

3. Select your scanner or printer from **Scanners**.

Normally, the MAC address of your scanner or printer is already selected after the network setup. In that case, you do not need to select it again.

Important

- If multiple scanners exist on the network, multiple model names appear. In that case, you can select one scanner per model.



4. Click **OK**.

Note

- The scanner selected in the Scan-from-PC Settings screen will be automatically selected in the Scan-from-Operation-Panel Settings screen as well.

Setting for Scanning with IJ Scan Utility

To scan from IJ Scan Utility using a scanner or printer connected to a network, specify your scanner or printer with IJ Network Scanner Selector EX, then follow the steps below to change the connection status between it and the computer.

1. [Start IJ Scan Utility](#).
2. Select "Canon XXX series Network" (where "XXX" is the model name) for **Scanner**.
3. Click  **Settings...** to use another scanner connected to a network.
4. Click  (General Settings), then click **Select** in **Product Name**.

The Scan-from-PC Settings screen of IJ Network Scanner Selector EX appears.

Select the scanner you want to use and click **OK**.

5. In the **Settings (General Settings)** dialog box, click **OK**.

The IJ Scan Utility main screen reappears. You can scan via a network connection.

Setting for Scanning from the Operation Panel



You can make the setting for scanning from the operation panel.

Important

- Set IJ Scan Utility to use your scanner or printer via a network connection beforehand.

➔ [Setting for Scanning with IJ Scan Utility](#)

1. Check that IJ Network Scanner Selector EX is running.

If IJ Network Scanner Selector EX is running,  (IJ Network Scanner Selector EX2) appears in the notification area on the desktop. Click  to check the hidden icons as well.

Note

- If the icon is not displayed in the notification area on the desktop, follow the procedure below to start.

- **Windows 11/Windows 10:**

From the **Start** menu, click (**All apps >**) **Canon Utilities > IJ Network Scanner Selector EX2**.

- **Windows 8.1:**

Click **IJ Network Scanner Selector EX2** on the Start screen.

If **IJ Network Scanner Selector EX2** is not displayed on the Start screen, select the **Search** charm, then search for "IJ Network Scanner Selector EX2".

- **Windows 7:**

From the **Start** menu, click **All Programs > Canon Utilities > IJ Network Scanner Selector EX2 > IJ Network Scanner Selector EX2**.

The icon appears in the notification area on the desktop, and the Scan-from-PC Settings screen appears. In that case, skip ahead to Step 3.

2. In the notification area on the desktop, right-click  (IJ Network Scanner Selector EX2), then select **Settings...**

The Scan-from-PC Settings screen appears.

3. Click **Scan-from-Operation-Panel Settings**.

The Scan-from-Operation-Panel Settings screen appears.

4. Select your scanner or printer from **Scanners** and click **OK**.

Select the MAC address of your scanner or printer.

▶▶▶ Note

- When multiple scanners are connected via a network, you can select up to three scanners.

5. In the Scan-from-PC Settings screen, click **OK**.

▶▶▶ Note

- If your scanner or printer does not appear, check the following, click **OK** to close the screen, then reopen it and try selecting again.
 - MP Drivers is installed
 - Network settings of your scanner or printer is completed after installing the MP Drivers
 - Network communication between your scanner or printer and computer is enabled

If the problem is still not solved, see [Network Communication Problems](#).

IJ Network Scanner Selector EX2 Menu and Setting Screen

IJ Network Scanner Selector EX2 allows you to select the scanners or printers to be used for scanning or printing over a network from your computer or the operation panel.

After installation, IJ Network Scanner Selector EX2 appears in the notification area on the desktop.

▶▶▶ Important

- If you cannot scan over a network, download and upgrade to the latest MP Drivers from our website.
- While IJ Network Scanner Selector EX2 is enabled, it periodically transmits packets to check whether it can communicate with your scanner or printer over the network. When using the computer in a network environment other than the one used to set up your scanner or printer, disable IJ Network Scanner Selector EX2.

▶▶▶ Note

- If the icon is not displayed in the notification area on the desktop, follow the procedure below to start.
 - **Windows 11/Windows 10:**
From the **Start** menu, click **(All apps >) Canon Utilities > IJ Network Scanner Selector EX2**.
 - **Windows 8.1:**
Click **IJ Network Scanner Selector EX2** on the Start screen.
If **IJ Network Scanner Selector EX2** is not displayed on the Start screen, select the **Search** charm, then search for "IJ Network Scanner Selector EX2".
 - **Windows 7:**
From the **Start** menu, click **All Programs > Canon Utilities > IJ Network Scanner Selector EX2 > IJ Network Scanner Selector EX2**.

Menu

Displays a menu when you right-click  (IJ Network Scanner Selector EX2) in the notification area on the desktop.

Disable Canon IJ Network Scanner Selector EX2 / Enable Canon IJ Network Scanner Selector EX2

Enables or disables IJ Network Scanner Selector EX2.

When you select **Disable Canon IJ Network Scanner Selector EX2**, you will not be able to scan over a network from the operation panel.

Enabled:  , Disabled: 

▶▶▶ Important

- When using a model with which you cannot scan over a network from the operation panel, you cannot scan using the operation panel even if this setting is enabled.

Settings...



The Scan-from-PC Settings screen appears. You can select the model you want to use.

About

Displays the version information.

In the displayed dialog box, you can change the language to be used in the application. The change will be reflected after restarting the computer.

Exit

Exits IJ Network Scanner Selector EX2;  (Enabled) or  (Disabled) disappears from the notification area on the desktop.

Scan-from-PC Settings Screen

Right-click the icon from the notification area on the desktop, then select **Settings...** to display the Scan-from-PC Settings screen.

Your scanner or printer must be selected with IJ Network Scanner Selector EX2 before scanning over a network.

Scanners

MAC addresses of the scanners or printers that can be used over the network are displayed.

You can select one scanner or printer per model. Selecting a scanner or printer automatically enables scanning from the operation panel.

Instructions

Opens this guide.

Scan-from-Operation-Panel Settings

The **Scan-from-Operation-Panel Settings** screen appears. You can select up to three scanners and printers in total for scanning from the operation panel. You can scan items using the operation panel of the selected scanner or printer, and send the scanned images to your computer over a network.

Important

- When using a model with which you cannot scan over a network from the operation panel, that model does not appear in **Scanners** and the setting is not available.

Scan-from-Operation-Panel Settings Screen

Click **Scan-from-Operation-Panel Settings** in the Scan-from-PC Settings screen to display the **Scan-from-Operation-Panel Settings** screen.

Scanners

MAC addresses of the scanners or printers that can be used over the network are displayed.

You can select up to three scanners and printers in total at the same time. Selecting a scanner or printer automatically enables scanning from the operation panel.

Instructions

Opens this guide.

▶▶ Important

- When using a model with which you cannot scan over a network from the operation panel, **Scan-from-Operation-Panel Settings** may appear in the Scan-from-PC Settings screen; however, the setting is not available.

▶▶ Note

- If your scanner or printer does not appear, check the following, click **OK** to close the screen, then reopen it and try selecting again.
 - MP Drivers is installed
 - Network settings of your scanner or printer is completed after installing the MP Drivers
 - Network communication between your scanner or printer and computer is enabled

If the problem is still not solved, see Network Communication Problems.

- You do not need to use this software when scanning via USB. Refer to "[Uninstalling IJ Network Scanner Selector EX2](#)" to delete it. You can scan via USB even if it is not deleted.

Uninstalling IJ Network Scanner Selector EX2

Follow the procedure below to uninstall IJ Network Scanner Selector EX2 from your computer.

►► Important

- You cannot scan over a network after uninstalling IJ Network Scanner Selector EX2.
- Log into a user account with administrator privilege.

1. Click **Control Panel > Programs > Programs and Features**.
2. Select **Canon IJ Network Scanner Selector EX2**, then click **Uninstall/Change**.

►► Note

- If the **User Account Control** screen appears, click **Continue**.

3. Click **Yes** when the confirmation message appears.
4. When uninstallation is complete, click **OK**.

►► Note

- When the message prompting you to restart your computer appears, click **OK** to restart your computer.

Updating the ScanGear (Scanner Driver)

- **Obtaining the Latest ScanGear (Scanner Driver)**
- **Deleting the Unnecessary ScanGear (Scanner Driver)**
- **Before Installing the ScanGear (Scanner Driver)**
- **Installing the ScanGear (Scanner Driver)**

Obtaining the Latest ScanGear (Scanner Driver)

Upgrading your current ScanGear (scanner driver) to the latest ScanGear may solve some problems you have experienced.

Checking the Version of ScanGear

Start ScanGear and click  (Information) to display the version of ScanGear.

Obtaining ScanGear

To obtain ScanGear, access our website, and then download the ScanGear for your model.

»» Important

- ScanGear can be downloaded for free; however, Internet connection fees apply.
- Install the latest ScanGear after deleting the old one. Refer to "[Deleting the Unnecessary ScanGear \(Scanner Driver\)](#)" for how to delete ScanGear.

Related Topic

- ➔ [Before Installing the ScanGear \(Scanner Driver\)](#)
- ➔ [Installing the ScanGear \(Scanner Driver\)](#)

Deleting the Unnecessary ScanGear (Scanner Driver)

You can delete the ScanGear (scanner driver) you no longer use.

When deleting ScanGear, close all running applications, and then remove the USB cable connecting the scanner and computer.

1. From **Control Panel**, click **Programs > Programs and Features**.
2. Double-click **CanoScan XXX Scanner Driver** (where "XXX" is model name).
3. When the **Scanner Driver Uninstall** dialog box appears, click **Execute**.
4. When a confirmation appears, click **Yes**.
5. When uninstallation is complete, click **Complete**.

ScanGear is deleted.

▶▶▶ Note

- A confirmation or warning dialog box may appear when installing, uninstalling, or starting up software. This dialog box appears when administrative rights are required to perform a task. If you are logged on to an administrator account, click **Yes** (or **Continue**, **Allow**) to continue.

Before Installing the ScanGear (Scanner Driver)

Check the following points before installing ScanGear (scanner driver). Check these also when you cannot install ScanGear.

Scanner Status

- If the scanner and computer are connected with a USB cable, disconnect the USB cable from the computer.
- Turn off the scanner.

Computer Settings

- Close all running applications.
- Log in as the administrator of the computer.

▶▶▶ Note

- If an older version of ScanGear is already installed, delete (uninstall) it beforehand. Refer to "[Deleting the Unnecessary ScanGear \(Scanner Driver\)](#)" for how to delete ScanGear.

Related Topic

- ➔ [Updating the ScanGear \(Scanner Driver\)](#)
- ➔ [Installing the ScanGear \(Scanner Driver\)](#)

Installing the ScanGear (Scanner Driver)

To download the latest ScanGear (scanner driver), access our website via the Internet.

Follow these steps to install the downloaded ScanGear.

1. Double-click the icon of the downloaded file.

The installation program starts.

»» Note

- A confirmation or warning dialog box may appear when installing, uninstalling, or starting up software. This dialog box appears when administrative rights are required to perform a task. If you are logged on to an administrator account, click **Yes** (or **Continue**, **Allow**) to continue.

Some applications require administrator account to continue. If you are logged on to a standard account, switch to an administrator account and start over.

2. In the Welcome screen, click **Next**.

3. Read and understand the License Agreement, then click Yes.

ScanGear installation starts.

4. Connect scanner and computer with supplied USB cable.

The computer recognizes the scanner.

ScanGear is installed.

5. When the Installation Complete screen appears, click **Complete**.

A message prompting you to restart the computer may appear depending on your environment. Restart the computer to complete the installation properly.

»» Important

- ScanGear can be downloaded for free; however, Internet connection fees apply.

Related Topic

- ➔ [Obtaining the Latest ScanGear \(Scanner Driver\)](#)
- ➔ [Deleting the Unnecessary ScanGear \(Scanner Driver\)](#)
- ➔ [Before Installing the ScanGear \(Scanner Driver\)](#)

Scanning with WIA Driver

You can scan an item from a WIA (Windows Image Acquisition)-compliant application.

The procedure varies depending on the application. The following procedures are examples only.

Refer to the application's manual for details.

▶▶ Important

- Available functions, the displayed items, and available settings vary depending on your model.
- Some applications do not support continuous scanning from the ADF (Auto Document Feeder). Refer to the application's manual for details.
- Follow these steps to enable scanning over a network.

— Windows 11/Windows 10/Windows 8.1:

1. Right-click **Start** menu, and then select **File Explorer > Network**.
2. In **Network** menu of displayed screen, select **Add devices and printers**.
3. In screen for adding device, select **XXX_MAC address** (where "XXX" is model name), and then click **Next**.

— Windows 7:

1. From **Start** menu, select **Computer > Network**.
2. Right-click **XXX_MAC address** (where "XXX" is model name) in the displayed screen, then select **Install**.

The setting may have been completed already depending on your environment. In that case, **Uninstall** appears.

Scanning with WIA Driver 2.0

The following is an example of scanning using "Windows Fax and Scan."

1. Place items on platen or ADF.

➡ [Positioning Originals \(Scanning from Computer\)](#)

2. Select **New** on the **File** menu of "Windows Fax and Scan," then click **Scan...**

The scan setting screen appears.

▶▶ Note

- If you have more than one scanner or printer, a scanner selection screen may appear. Double-click the scanner you want to use.
 - For USB connection: **Canon XXX series** (where "XXX" is the model name)
 - For network connection: **XXX series_MAC address** (where "XXX" is the model name)

3. Specify the settings.

Scanner

The currently set product name is displayed. To change the scanner, click **Change...** and select the product you want to use.

Profile

Select **Photo (Default)** or **Documents** according to the type of item to be scanned. To save a new **Profile**, select **Add profile...** You can specify the details in the **Add New Profile** dialog box.

Source

Select a scanner type. To scan from the platen, select **Flatbed**. To scan from the ADF, select **Feeder (Scan one side)** or **Feeder (Scan both sides)**.

Paper size

Select the paper size. **Paper size** can be set only when **Source** is **Feeder (Scan one side)** or **Feeder (Scan both sides)**.

Color format

Select the color mode in which to scan the item.

File type

Select a data format from BMP, JPEG, PNG, and TIFF.

Resolution (DPI)

Enter the resolution. Specify a value between 50 dpi and 600 dpi.

➔ [Resolution](#)

»» Note

- When using the scanner or printer with network connection, the following resolutions can be specified.
150 dpi / 300 dpi / 600 dpi

Brightness

Move the slider to adjust the brightness. Move it to the left to darken and right to brighten the image. You can also enter a value (-100 to 100).

Contrast

Move the slider to adjust the contrast. Moving it to the left will decrease the contrast of the image, thus softening the image. Moving it to the right will increase the contrast of the image, thus sharpening the image. You can also enter a value (-100 to 100).

Preview or scan images as separate files

Select this checkbox to preview or scan multiple images as separate files.

»» Important

- When using the scanner or printer with network connection, you cannot specify **Brightness**, **Contrast**, and **Preview or scan images as separate files**.

4. Click **Preview** to preview the image.

The preview image appears on the right.

»» Important

- With network connection, scan without preview when scanning documents from the ADF. If you preview, place the document again and scan.

If there is document left in the ADF after previewing, press the **OK** button on the operation panel and remove the document.

5. Click **Scan**.

Scanning starts, then the scanned image appears in the application.

Scanning with WIA Driver 1.0

The following is an example of scanning using "Paint."

1. Place items on platen or ADF.

➔ [Positioning Originals \(Scanning from Computer\)](#)

2. Click **From scanner or camera** from the **File** menu of Paint. (Select the command to scan an item in the application.)

▶▶▶ Note

- If you have more than one scanner or printer, a scanner selection screen may appear. Double-click the scanner you want to use.
 - For USB connection: **Canon XXX series** (where "XXX" is the model name)
 - For network connection: **XXX series_MAC address** (where "XXX" is the model name)

3. Select the paper source and type of picture according to the item to be scanned.

To scan from the platen, select **Flatbed** for **Paper source**. To scan from the ADF, select **Document Feeder**.

Select the type of picture from **Color picture**, **Grayscale picture**, **Black and white picture or text**, and **Custom Settings**.

▶▶▶ Note

- When using the scanner or printer with network connection, the options for the type of picture may differ from those displayed with USB connection.
- To scan with the values previously set in **Adjust the quality of the scanned picture**, select **Custom Settings**.
- Selecting **Document Feeder** for **Paper source** enables you to select **Page size**.

4. Click **Adjust the quality of the scanned picture** and set the preferences as required.

Brightness

Move the slider to adjust the brightness. Move it to the left to darken and right to brighten the image. You can also enter a value (-127 to 127).

Contrast

Move the slider to adjust the contrast. Moving it to the left will decrease the contrast of the image, thus softening the image. Moving it to the right will increase the contrast of the image, thus sharpening the image. You can also enter a value (-127 to 127).

Resolution (DPI)

Enter the resolution. Specify a value between 50 dpi and 600 dpi.

➔ [Resolution](#)

▶▶▶ Note

- When using the scanner or printer with network connection, the following resolutions can be specified.
150 dpi / 300 dpi / 600 dpi

Picture type

Select the type of scan you want for your item.

Reset

Click to restore the original settings.

▶▶▶ Important

- When using the scanner or printer with network connection, you cannot specify **Brightness** and **Contrast**.

5. Click **Preview** to preview the image.

The preview image appears on the right. Drag to specify the scan area.

▶▶▶ Important

- With network connection, scan without preview when scanning documents from the ADF. If you preview, place the document again and scan.
If there is document left in the ADF after previewing, press the **OK** button on the operation panel and remove the document.

6. Click **Scan**.

Scanning starts, then the scanned image appears in the application.

Resolution

The data in the image you have scanned is a collection of dots carrying information about brightness and color. The density of these dots is called "resolution," and resolution will determine the amount of detail your image contains. The unit of resolution is dots per inch (dpi). Dpi is the number of dots per inch (2.5 cm).

The higher the resolution (value), the more detail in your image; the lower the resolution (value), the less detail.



How to Set the Resolution

You can set the resolution in the following screens.

IJ Scan Utility:



Resolution on the (Scanning from a Computer) tab of the Settings dialog box

ScanGear (Scanner Driver):

Output Resolution in **Output Settings** on the **Advanced Mode** tab

Appropriate Resolution Settings

Set the resolution according to the use of the scanned image.

Item Type	Use	Color Mode	Appropriate Resolution
Color photo	Copying (Printing)	Color	300 dpi
	Creating a postcard	Color	300 dpi
	Saving to a computer	Color	300 dpi
	Using on a website or attaching to e-mail	Color	150 dpi
Black and white photo	Saving to a computer	Grayscale	300 dpi
	Using on a website or attaching to e-mail	Grayscale	150 dpi
Text document (document or magazine)	Copying	Color, Grayscale, or Black and White	300 dpi
	Attaching to e-mail	Color, Grayscale, or Black and White	150 dpi

	Scanning text using OCR	Color or Grayscale	300 dpi
--	-------------------------	--------------------	---------

►► Important

- If you double the resolution, the data size of the scanned image quadruples. If the file is too large, the processing speed will slow down significantly, and you will experience inconvenience such as lack of memory. Set the minimum required resolution according to the use of the image.

►► Note

- When you will be printing the scanned image by enlarging it, scan by setting a higher resolution than the recommended one above.

Data Formats

You can select a data format when saving scanned images. You should specify the most suitable data format according to how you want to use the image on which application.

Available data formats vary by application and operating system (Windows or Mac OS).

See below for the characteristics of each image data format.

PNG (Standard File Extension: .png)

A data format often used on websites.

PNG is suitable for editing saved images.

JPEG (Standard File Extension: .jpg)

A data format often used on websites and for digital camera images.

JPEG features high compression rates. JPEG images slightly degrade every time they are saved, and cannot be returned to their original state.

JPEG is not available for black and white images.

TIFF (Standard File Extension: .tif)

A data format featuring a relatively high compatibility between various computers and applications.

TIFF is suitable for editing saved images.

»» Note

- Some TIFF files are incompatible.
- IJ Scan Utility supports the following TIFF file formats.
 - Uncompressed, black and white binary
 - Uncompressed, RGB (8 bits per channel)
 - Uncompressed, Grayscale

PDF (Standard File Extension: .pdf)

A data format for electronic documents, developed by Adobe Systems Incorporated.

It can be used on various computers and operating systems, and fonts can be embedded as well; therefore, people in different environments can exchange the files without being aware of the differences.

Color Matching

"Color Matching" is the act of making adjustments so that the color tones match between the original item, the monitor display, and the color printout. On your scanner or printer, the color tones are adjusted as shown below.

Example: When sRGB is selected as the output profile (target):

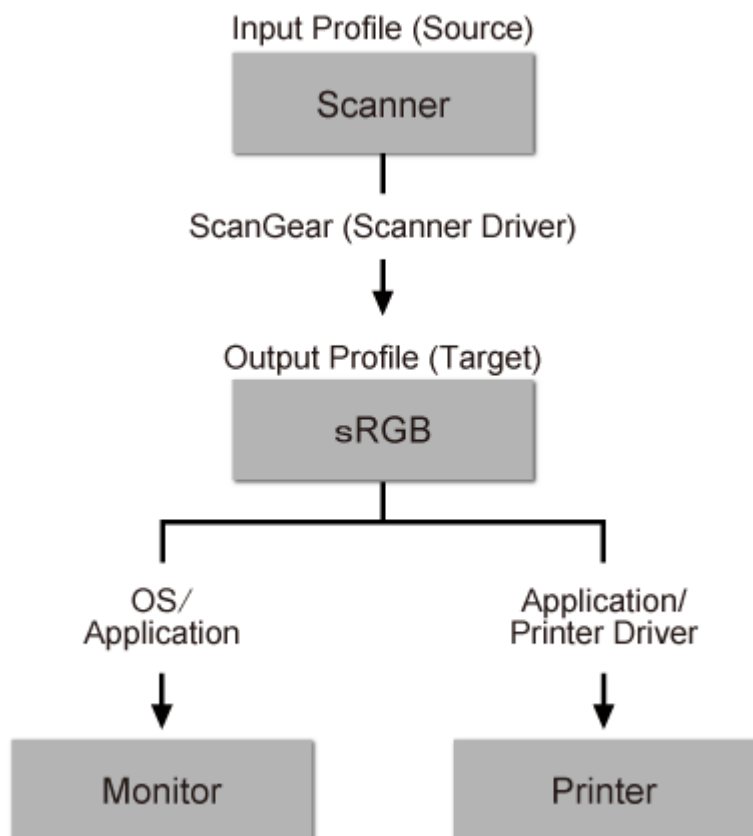

The image's color space is converted from the scanner's color space to sRGB by ScanGear.

When displaying on a monitor, the image's color space is converted from sRGB to the monitor's color space based on the operating system's monitor settings and the application's working space settings.

When printing, the image's color space is converted from sRGB to the printer's color space based on the application's print settings and the printer driver's settings.

Setting Up Operation Panel with IJ Scan Utility (Windows)

IJ Scan Utility allows you to specify how to respond when scanning from the operation panel.

»» Important

- Depending on your model, you cannot scan from the operation panel.

1. [Start IJ Scan Utility.](#)

2. Click  **Settings...**

The Settings dialog box appears.

3. Select a scan mode on the  (Scanning from the Operation Panel) tab.

»» Note

- For the setting items in the Settings dialog box, see [Settings \(Scanning from the Operation Panel\) dialog box.](#)

4. Set **Scan Options**.

5. Specify the file name and other settings in **Save Settings**.

6. Select the application you want to start after scanning in **Application Settings**.

7. Click **OK**.

The responses will be executed according to the specified settings when you start scanning from the operation panel.

Printer Driver

- [Windows Printer Driver](#)
- [macOS Printer Driver](#)

Windows Printer Driver

- **Overview of the Printer Driver**
- **Printer Driver Description**
- **Updating the Printer Driver**

Overview of the Printer Driver

- **Canon IJ Printer Driver**
- **Changing the Print Options**
- **Canon imagePROGRAF Preview**
- **How to Open the Printer Driver Setup Window**
- **Updating Media Information in Printer Driver**
- **Deleting the Undesired Print Job**
- **Canon IJ Status Monitor**
- **Instructions for Use (Printer Driver)**

Canon IJ Printer Driver

The Canon IJ printer driver (called printer driver below) is a software that is installed on your computer for printing data with this printer.

The printer driver converts the print data created by your application software into data that your printer can understand, and sends the converted data to the printer.

Because different models support different print data formats, you need a printer driver for the specific model you are using.

Installing the Printer Driver

To install the printer driver, install the driver from the Setup CD-ROM or our website.

Specifying the Printer Driver

To specify the printer driver, open the **Print** dialog box of the application software you are using, and select "XXX" (where "XXX" is your model name).

Displaying the Manual from the Printer Driver

To display a description of a tab in the printer driver setup window, click the **Help** button found on the tab.

Related Topic

➔ [How to Open the Printer Driver Setup Window](#)

Changing the Print Options

You can change the detailed printer driver settings for print data that is sent from an application software.

Check this check box if part of the image data is cut off, the paper source during printing differs from the driver settings, or printing fails.

The procedure for changing the print options is as follows:

1. Open the [printer driver setup window](#)
2. Click **Special Settings...** on the **Layout** tab

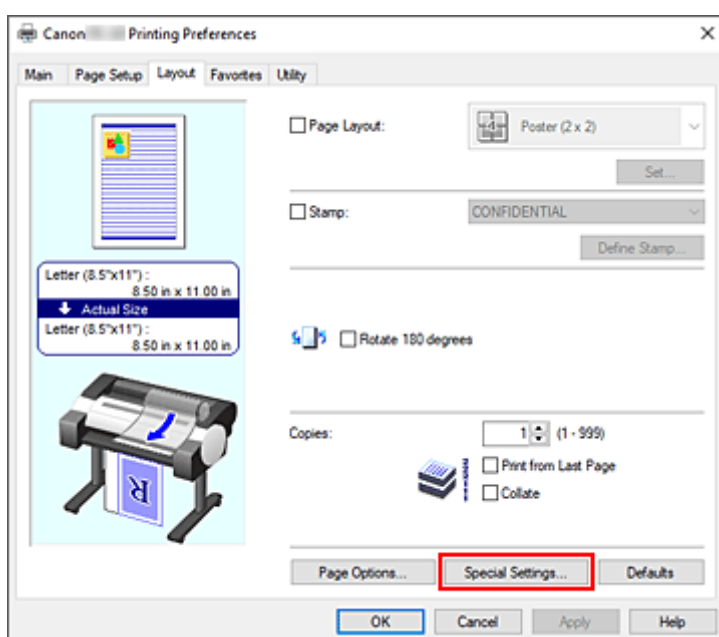

The **Special Settings** dialog box opens.

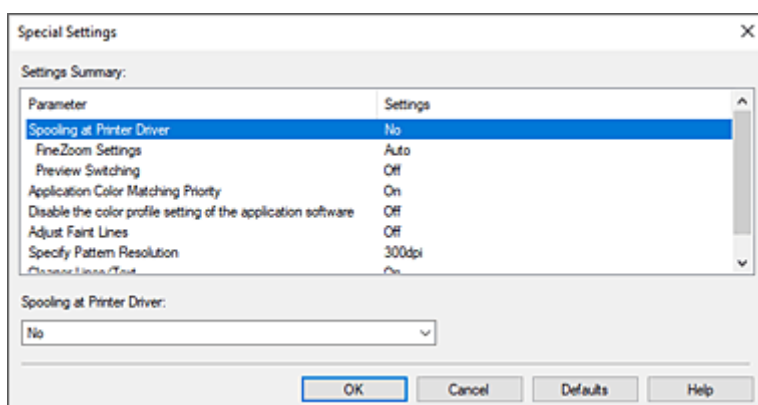

3. Change the individual settings

If necessary, change the setting of each item, and then click **OK**.

The **Layout** tab is displayed again.

Canon imagePROGRAF Preview

The Canon imagePROGRAF Preview is an application software that displays what the print result will look like before a document is actually printed.

The preview reflects the information that is set within the printer driver and allows you to check the document layout, print order, and number of pages. You can also change the media type and paper source settings.

When you want to display a preview before printing, open the [printer driver setup window](#), click the **Main** tab, and check the **Preview before printing** check box.

When you do not want to display a preview before printing, uncheck the check box.

Related Topic

➔ [Displaying the Print Results before Printing](#)

How to Open the Printer Driver Setup Window

You can display the printer driver setup window from the application software in use or from the printer icon.

Open the Printer Driver Setup Window through the Application Software

Follow the procedure below to configure printing profile when printing.

1. Select the command that you perform printing on the application software

In general, select **Print** on the **File** menu to open the **Print** dialog box.

2. Select your model name and click **Preferences** (or **Properties**)

The printer driver setup window appears.

▶▶▶ Note

- Depending on application software you use, command names or menu names may vary and there may be more steps. For details, refer to the user's manual of your application software.

Opening the Printer Driver Setup Window from the Printer Icon

Follow the procedure below to perform printer maintenance operations such as print head cleaning, or to configure a printing profile that is common to all application software.

1. Display the **Devices and Printers** window

Select the **Control Panel** -> **Hardware and Sound (Hardware)** -> **Devices and Printers**.

2. Right-click your model name icon, and then select **Printing preferences** from the displayed menu

The printer driver setup window appears.

▶▶▶ Important

- Opening the printer driver setup window through **Printer properties** displays such tabs regarding the Windows functions as the **Ports** (or **Advanced**) tab. Those tabs do not appear when opening through **Printing preferences** or application software. For tabs regarding Windows functions, refer to the user's manual for the Windows.

Updating Media Information in Printer Driver

This function gets the latest media information from the printer and updates the media information in the printer driver.

When the media information is updated, the media displayed for **Media Type** on the **Main** tab is updated to the latest information.

The procedure for updating media information is described below.

1. Display the **Devices and Printers** window

Select the **Control Panel -> Hardware and Sound (Hardware) -> Devices and Printers**.

The **Devices and Printers** window is displayed.

2. Display setup window

Right-click the "Your model name" icon, and select **Printer properties**.

The printer's **Properties** window appears.

3. Update media information

Click **Update Media Information** the **Device Settings** tab.

When a confirmation message appears, click **Start**.

If the paper information on the driver cannot be updated, click **Initial Check Items** and check the displayed information.

The printer driver media information will update.

▶▶▶ Important

- It may take some time to update the media information.

4. Finish updating media information

When a confirmation message appears, click **OK**.

The media information will be updated.

▶▶▶ Important

- Restart the printer driver after updating media information.
- Do not change media information on the printer while you are updating media information on the driver.

▶▶▶ Important

- Ensure that a user with administrative privileges carries out the media information update. Users other than administrators can check if a media information update is required, but cannot carry out the update itself.
- When you have added, deleted, or edited media using administrative tools (the Media Configuration Tool) but have not updated the media information, issues may arise such as the inability to print.

Deleting the Undesired Print Job

If the printer does not start printing, canceled or failed print job data may be remaining. Delete the undesired print job by using the Canon IJ Status Monitor.

1. Open the [printer driver setup window](#)

2. Display the Canon IJ Status Monitor

Click **Status Monitor...** on the **Main** tab.

The Canon IJ Status Monitor appears.

3. Display the print jobs

Click **Display Print Queue**.

The print queue window opens.

4. Delete the print jobs

Select the print jobs you want to delete, and select **Cancel** from the **Document** menu.

When the confirmation message appears, click **Yes**.

The deletion of the print job is complete.

Important

- Users who have not been granted access permission for printer management cannot delete the print job of another user.

Canon IJ Status Monitor

The Canon IJ Status Monitor is an application software that shows the status of the printer and the progress of printing. You will know the status of the printer with graphics, icons, and messages.

Launching the Canon IJ Status Monitor

The Canon IJ Status Monitor launches automatically when print data is sent to the printer. When launched, the Canon IJ Status Monitor appears as a button on the task bar.

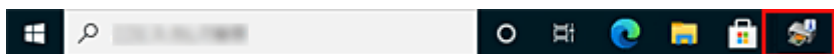

Click the button of the status monitor displayed on the task bar. The Canon IJ Status Monitor appears.

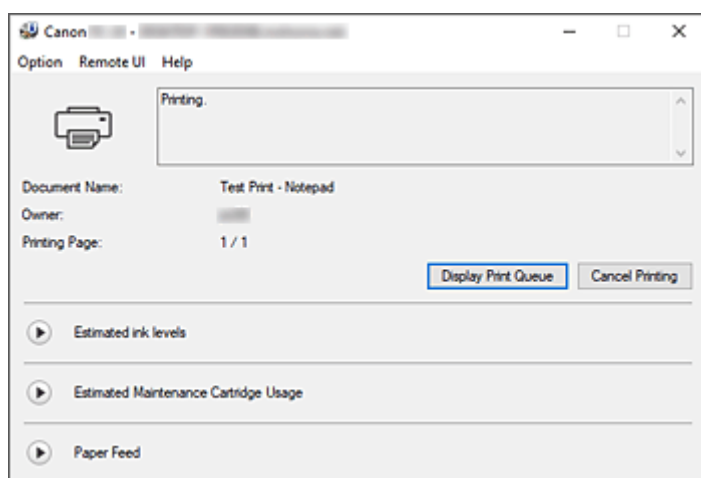

Note

- To open the Canon IJ Status Monitor when the printer is not printing, open the [printer driver setup window](#) and click **Status Monitor...** on the **Main** tab.
- The information displayed on the Canon IJ Status Monitor may differ depending on the country or region where you are using your printer.

When Errors Occur

If an error occurs (e.g., if the printer runs out of paper or if the ink is low), the Canon IJ Status Monitor displays an error information dialog box.

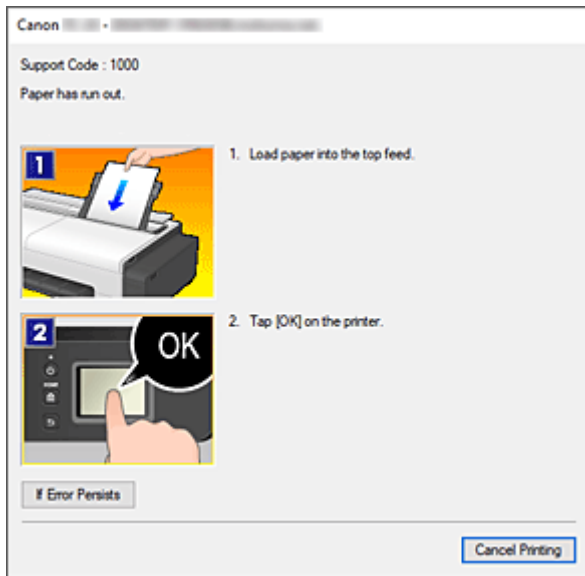

In such cases, take the appropriate action as described.

Checking the Ink Status from Your Computer

You can check the remaining ink level and the ink tank types for your model.

1. Open the [printer driver setup window](#)
2. Launching the Canon IJ Status Monitor

On the **Main** tab, click **Status Monitor...**
The Canon IJ Status Monitor opens.

3. Display **Estimated ink levels**

Ink status is displayed as an illustration.

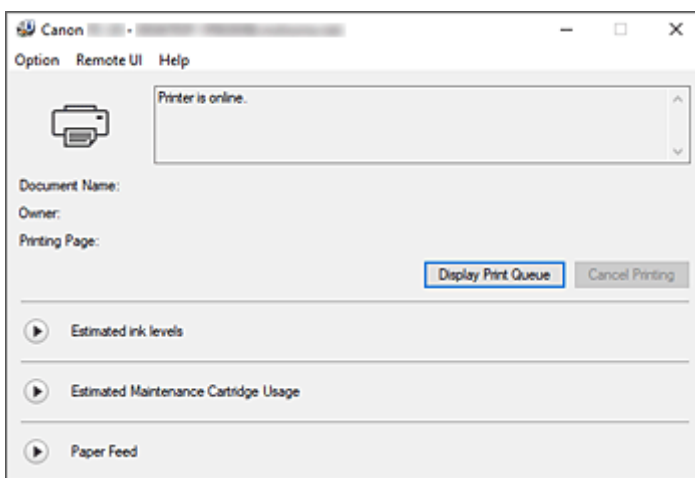

►►► Note

- The information displayed on the Canon IJ Status Monitor may differ depending on the country or region where you are using your printer.

Instructions for Use (Printer Driver)

This printer driver is subject to the following restrictions. Keep the following points in mind when using the printer driver.

Restrictions on the Printer Driver

- Before installing, log on to Windows as user with administrator rights.
- Always check the following before installing the software.
 1. Quit the application software while it is running.
 2. If you are printing a document, abort printing or wait for it to finish.
 3. Close all the printer driver's dialog boxes.
- If you can set the number of copies with the application software, set them either with the printer driver or the application software.
- If you can configure enlarging/reducing settings with the application software, set the normal size (100%) in the printer driver, and then configure the magnification factor with the application software.
- Depending on the application software used, it may be possible to print collated copies; however, please do not use this feature when configuring layout printing with the **Page Layout** option in the **Layout** tab.

This may cause incorrect layout.
- When printing enlarged/reduced documents, printed results may come out different due to a discrepancy between the image data resolution and the enlarging/reducing ratio.
- When printing reduced color images, 1-dot wide lines or points may disappear from the color images.
- Depending on the application software, lines drawn at almost horizontal angles may not print correctly.

If that should happen, re-draw the line horizontally and print one more time.
- Immediately after installing (or updating) the printer driver, you might not be able to visualize new features in some of the application software.

In all application software provided with printing features, choose Print from the File menu and, after selecting the printer you are using, click the Properties.
After the Properties dialog box has opened, immediately close it by clicking OK.
- If you update the model name of your printer through the **General** tab in the printer's Properties, the **Favorites** settings registered in the printer driver will be disabled.

In such cases, save the Favorites settings as a file before changing the name of the printer and reload the saved file after you have updated the printer's name.
- Printing at high resolution requires a large amount of memory on your computer.

When your computer is low on memory or you are using a large number of application software, the application software may not work correctly.
In such cases, re-start Windows and, before resuming printing, close all the applications you are not using. Also, when the printer is not printing correctly, switch the **Print Quality** setting in the **Main** tab to a lower resolution.
- When using a local connection, if you do not see a check mark next to the **Enable bidirectional support** option in the **Ports** tab in the printer's Properties, it will not be possible to acquire printer and device information correctly.
- If you are using your printer with a USB connection, refrain from using standby mode. You can set standby mode through the **Power Options** on the **Control Panel**.

- In case of a large amount of print data, the printer may time-out during printing and you may no longer be able to print.
In such cases, in the **Advanced** tab in the printer's Properties, choose **Spool print documents so program finishes printing faster** and place a check mark next to **Start printing after last page is spooled**.
- Fine lines and gradients may not print correctly.
In such cases, choose Print from the File menu of the application, and after opening from there the property dialog box of the printer driver, follow the procedure below and then run printing.
 1. In the **Main** tab, uncheck **Preview before printing**.
 2. In the **Layout** tab, uncheck **Page Layout**.
 3. If you are using a 32-bit driver, open the **Layout** tab and click **Special Settings....**
Turn off **Fast Graphic Process**.
- In case of a large amount of print data, the printer may time-out during printing and you may no longer be able to print.
In such cases, you may be able to print by increasing the time set in Job timeout in the printer's operation panel.
- Depending on the application used, if you print using features like enlarging/reducing, layout printing, page borders and so on, some of the data in the resulting printed document, for example graphics, may differ from the source document.
- If you print very large images from your computer when it's running low on memory, you may not be able to print correctly; for example, it may take a very long time to print or parts of the image may end up missing.
In such cases, try printing after following the procedure indicated below.
 - If you are using a 32-bit driver, open the **Layout** tab and click **Special Settings....**
Turn off **Fast Graphic Process**.
 - Increase your computer memory.
 - Increase the virtual memory of your operating system.
- Do not change the **Print Processor...** settings in the **Advanced** tab in the printer Properties.
If you change them, you will not be able to use some of the features correctly, such as the **Page Layout** feature in the **Layout** tab.
- In the cases described below, you will not be able to use the **Edit Using PosterArtist** feature of **Page Layout** in the **Layout** tab, as well as the Canon imagePROGRAF Preview feature.
 - When right-clicking on the printer icon and choosing from **See what's printing: Printer -> Pause Printing**, or when right-clicking on the printer icon and choosing **Pause Printing**
 - When right-clicking on the printer icon and choosing from **See what's printing: Printer -> Use Printer Offline**, or when right-clicking on the printer icon and choosing **Use Printer Offline**
 - When printing during hours other than those set in **Available from** and **To** in the **Advanced** tab in the printer's Properties
 - When printing with the **Enable advanced printing features** turned off in the **Advanced** tab in the printer's Properties
 - When printing with **Print directly to the printer** enabled in the **Advanced** tab in printer's Properties
 - When printing after the printing port in the **Ports** tab in the printer's Properties has changed to **FILE:**
 - When printing after choosing **Output to file** in the **Print** dialog box in the application software

- If you perform a point-and-print installation, you will not be able to use the **Edit Using PosterArtist** features of **Page Layout** in the **Layout** tab.
- If you print after setting **Edit Using PosterArtist**, refrain from printing from other drivers.
- If you combine specific **Print Quality** with large paper sizes, you may not be able to correctly print stamps and borders.
- In the Canon imagePROGRAF Preview, characters and fine lines visualized in the View screen may look differ from printed results. In such cases, try choosing the **Layout** tab, opening the **Special Settings** dialog and turning on **Preview Switching**.

Points to Note About Applications with Restrictions

- If, in Microsoft Excel, you place a checkmark next to the Collate and then you print more than one copy, or if you do **Entire workbook** after configuring different settings in each tab, you may not be able to perform layout printing nor to get the intended printing results.
- If you try to print data on a very large-size paper through applications like Adobe Illustrator, you may not be able to print.
In such cases, try printing after following the procedure indicated below.
 - Open the **Main** tab and uncheck **Preview before printing**.
 - If you are using a 32-bit driver, open the **Layout** tab and click **Special Settings....**
Turn off **Fast Graphic Process**.
 - Increase the virtual memory of your operating system.
 - If you are using Adobe Illustrator, turn off/on **Bitmap printing** in the Print dialog box.
- When printing from application software that does not allow EMF spooling, you will not be able to use the Edit Using PosterArtist feature of Page Layout in the Layout tab.
- When printing from Adobe Photoshop, tone jumps may occur in the gradation of black and white photographs.

Printer Driver Description

- **Main Tab Description**
- **Page Setup Tab Description**
- **Layout Tab Description**
- **Favorites Tab Description**
- **Utility Tab Description**
- **Device Settings Tab Description**
- **Canon IJ Status Monitor Description**

Main Tab Description

The **Main** tab allows you to create a basic print setup in accordance with the media type. Unless special printing is required, normal printing can be performed just by setting the items on this tab.

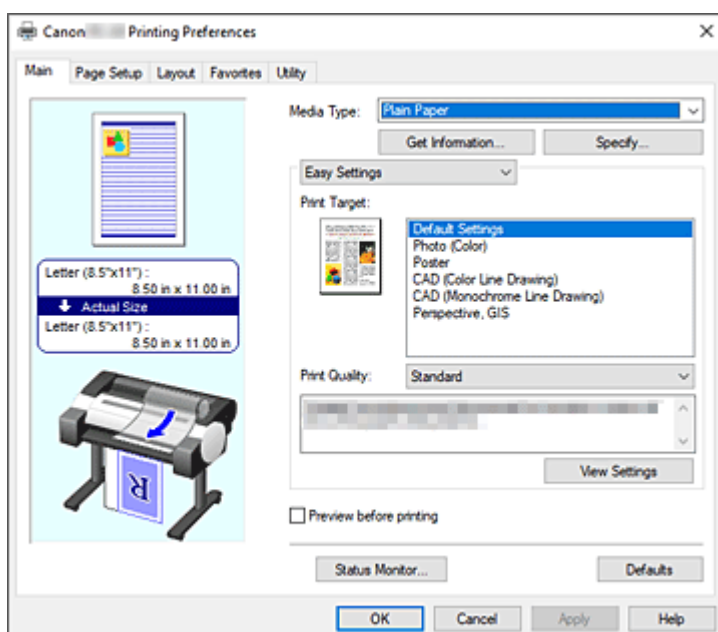

Settings Preview

The paper illustration shows how the original will be laid out on a sheet of paper.

You can check an overall image of the layout.

The printer illustration shows how to load paper to match the printer driver settings.

Check whether the printer is set up correctly by looking at the illustration before you start printing.

Media Type

Selects a type of printing paper.

Select a media type that matches the paper that is loaded in the printer. This ensures that printing is carried out properly for the specified paper.

Get Information...

Opens the **Paper Information on Printer** dialog box.

You can check the settings on the printer and apply the checked settings to the printer driver.

Specify...

Open the [Paper Detailed Settings dialog box](#), and specify detailed print settings that match the media type loaded in the printer.

Pull-down menu

Switches the **Easy Settings** and **Advanced Settings**.

Easy Settings

This mode allows you to print by using pre-registered print settings.

Print Target

Print settings that are generally used frequently are pre-registered as print purposes. By using a print purpose to print, you can print by using settings that match the document.

Default Settings

Select this when printing general documents such as business documents.

Photo (Color)

Select this when printing a color illustration or a photograph.

Poster

Select this when printing posters.

CAD (Color Line Drawing)

Select when printing data such as drawings.

CAD (Monochrome Line Drawing)

Select when printing data such as drawings in monochrome.

Perspective, GIS

Select when printing data such as perspectives and GIS.

Print Quality

Selects your desired printing quality.

Select one of the following to set the print quality level that is appropriate for the purpose.

»»» Important

- Depending on the **Media Type** settings, the same print results may be produced even if the **Print Quality** is changed.

High

Gives priority to print quality over printing speed.

Standard

Prints with average speed and quality. Resolution settings depend on media type.

Draft

Good for trial printing.

Custom

Opens the [Custom dialog box](#).

Select this when you want to set the printing quality level individually.

View Settings

Opens the [View Settings dialog box](#).

Advanced Settings

This mode allows you to print by specifying detailed settings that match your purpose.

Print Priority

Select elements to prioritize for print results.

Image

Prioritize image results when printing.

Line Drawing/Text

Prioritize detailed lines and text when printing.

Auto (Use Printer Settings)

Use printer settings when printing.

Print Quality

Selects your desired printing quality.

Select one of the following to set the print quality level that is appropriate for the purpose.

»» Important

- Depending on the **Media Type** settings, the same print results may be produced even if the **Print Quality** is changed.

High

Gives priority to print quality over printing speed.

Standard

Prints with average speed and quality. Resolution settings depend on media type.

Draft

Good for trial printing.

Custom

Opens the [Custom dialog box](#).

Select this when you want to set the printing quality level individually.

Color Mode

Select the color to print.

Color

Prints with the number of colors in the document.

Monochrome

Select this setting to print a line drawing using black ink.

Monochrome Bitmap

Print all non-white parts in black.

Color Settings

Opens the [Color Settings dialog box](#).

You can adjust individual color settings such as **Cyan**, **Magenta**, **Yellow**, **Brightness**, and **Contrast** on the **Color Adjustment** tab, and select the **Color Correction** method on the **Matching** tab.

Thicken Fine Lines

To make thin lines thicker and easier to see when printing, add a checkmark.

Preview before printing

You can start up the Canon imagePROGRAF Preview, and check what the printing results will be before executing the print.

Check this check box to display a preview before printing.

Status Monitor...

Displays the status monitor.

Defaults

Restores all the settings you have changed to their default values.

Clicking this button restores all the settings on the current screen to their default values (factory settings).

Paper Detailed Settings dialog box

Drying Time

Wait time can be set to allow ink to dry. **Between Pages** settings are only enabled for roll paper.

Between Pages

The wait time until outputting paper can be set after printing one page. Time is taken before cutting roll paper to allow the ink to dry, so the page may be dropped into the basket with dried ink.

Printer Default

Settings in printer unit operation panel are applied.

None

Page will be output immediately after printing

30 sec. / 1 min. / 3 min.

Page will be output after set amount of time has passed after printing.

Between Scans

The wait time until printing the next scan can be set after printing one scan in the page. Set to avoid smudging or unevenness in the page.

Printer Default

Settings in printer unit operation panel are applied.

None

Next scan will be print immediately after first scan is print.

0.5 sec./1 sec.

Next scan will be print after the set amount of time has passed after printing one scan.

* If smudges and/or unevenness occur, please increase time.

Roll Paper Safety Margin

The margin length on the edge of the paper can be selected.

Top/Bottom Margins

Set how images are printed relative to the margin amount on the roll paper.

Printer Default

Settings in printer unit operation panel are applied.

Prioritize Image Size

This setting adds margins to the outside of the print data. Larger margins make the printed material vertically longer, and more of the roll paper will be used.

Prioritize Paper Size

This setting adds margins to the inside of the print data. Larger margins increase the unprinted area at the top and bottom of the printed material.

▶▶▶ Important

- When using **Prioritize Paper Size**, the top and bottom of the image may be cut off depending on the margin amount you set. It is recommended that you consider the margins beforehand when creating the print data.

Leading Edge/Far End Margin

Set the margin length on each end of the roll paper.

Printer Default

Settings in printer unit operation panel are applied.

Auto

Automatically set the margin amount.

Leading Edge 5 mm / Far End 5 mm / Leading Edge 15 mm / Far End 15 mm / Leading Edge 30 mm / Far End 30 mm

Select a larger margin when rubbing of the print heads occurs, such as when heavily curling paper is being used.

Cut Speed

Select auto-cut speed. This can be adjusted when paper cannot be cut precisely with auto-cut.

Printer Default

Settings in printer unit operation panel are applied.

Fast

Select when cut is not smooth with **Standard** settings.

Standard

Select when there are no particular problems with auto-cut.

Slow

If this is selected for paper with adhesive, the cutter will not stick to the adhesive easily and it will slow deterioration of the cutter's capabilities.

Unidirectional Printing

Controls color unevenness and unaligned ruled lines.

Please check when printing in one direction.

Mirror

Select whether to print reflected image or not. When you select this check box, text and images will be printed as if reflected in a mirror.

Custom dialog box

Set the quality level, and select the desired print quality.

Quality

You can use the slider bar to adjust the print quality level.

Important

- Certain print quality levels cannot be selected depending on the settings of **Media Type**.

Note

- The **High**, **Standard**, or **Draft** print quality modes are linked with the slider bar. Therefore when the slider bar is moved, the corresponding quality and value are displayed on the left. This is the same as when the corresponding quality is selected for **Print Quality** on the **Main** tab.

View Settings dialog box

Print Target

Select the print purpose. The settings of the selected print purpose are displayed in **Details**.

Name

Displays the name of the selected print purpose.

Details

Displays the settings of the print purpose that was selected for **Print Target**.

Color Settings dialog box

Color Adjustment Tab

This tab allows you to adjust the color balance by changing the settings of the **Cyan, Magenta, Yellow, Brightness**, and **Contrast** options.

Preview

Shows the effect of color adjustment.

The color and brightness change when each item is adjusted.

View Color Pattern

Displays a pattern for checking color changes produced by color adjustment.

If you want to display the preview image with a color pattern, check this check box.

Cyan / Magenta / Yellow

Adjusts the strengths of **Cyan, Magenta, and Yellow**.

Moving the slider to the right makes a color stronger, and moving the slider to the left makes a color weaker.

You can also directly enter a value linked to the slider. Enter a value in the range from -50 to 50.

This adjustment changes the relative amount of ink of each color used, which alters the total color balance of the document. Use your application if you want to change the total color balance significantly. Use the printer driver only if you want to adjust the color balance slightly.

►► Important

- When **Monochrome** is selected for **Color Mode**, the color balance (**Cyan, Magenta, and Yellow**) can't be set.

Brightness

Adjusts the brightness of your print. You cannot change the levels of pure white and black.

However, the brightness of the colors between white and black can be changed. Colors become brighter as you drag the slider toward the right and darker as you drag the slider toward the left.

You can also directly enter brightness values that are linked to the slider bar. Enter a value in the range from -50 to 50.

Contrast

Adjusts the contrast between light and dark in the image to be printed.

Moving the slider to the right increases the contrast, moving the slider to the left decreases the contrast.

You can also directly enter a value linked to the slider. Enter a value in the range from -50 to 50.

Matching Tab

This is displayed when **Color** is selected for **Color Mode**.

Allows you to select the method for adjusting colors to match the type of document to be printed.

Color Correction

Allows you to select **Driver Matching**, **ICC Profile Matching**, **ICM**, or **Off** to match the purpose of the print operation.

Driver Matching

Print with the optimal color using the driver's original color profile. Normally, you should choose this mode.

ICC Profile Matching

Carry out color matching using the ICC profile. Specify the input profile, printer profile and matching method in detail, and select when printing. You can use the digital camera or scanner ICC profile, or the ICC profile created using the profile creation tool.

ICM

Perform color matching on the host computer using the Windows ICM function. Select when printing from an ICM function-compatible application.

Off

Print without performing color matching on the printer driver. Select this when performing color matching using applications such as Adobe Photoshop, or printing using a profile creation tool or color chart.

»» Important

- When setting not to use ICM in the application software, **ICC Profile Matching** and **ICM** of **Color Correction** do not function. There are also times when it does not print correctly.

Input Profile

Specifies the input profile to be used when you select **ICC Profile Matching** for **Color Correction**.

Printer Profile

Specifies the printer profile to be used when **ICC Profile Matching** is selected for **Color Correction**. Normally **Auto Settings** is selected but you can also select a printer profile manually.

Rendering Intent

Specifies the matching method to be used when you select **Driver Matching**, **ICC Profile Matching**, or **ICM**, for **Color Correction**.

Perceptual (Photo) / Perceptual

Reproduces colors of general photos naturally and features smooth gradation. In addition, selecting this setting allows you to adjust colors easily using an application software.

Saturation (Poster/CAD) / Saturation

Reproduces vivid colors on data such as a poster. In addition, prints in easy-to-see colors suitable for line drawing.

Relative Colorimetric

When image data is converted to the color space of the printer, this method converts the image data so the color reproduction approximates the shared color regions. Select this method to print image data with colors that are close to the original colors.

The white spots are reproduced as white spots (background color) on the paper.

Absolute Colorimetric

This method uses the white spot definitions in the input and output ICC profiles to convert the image data.

Although the color and color balance of the white spots change, you may not be able to get the desired output results because of the profile combination.

»» Important

- Depending on the media type, you may obtain the same print results even when you change the **Rendering Intent** setting.
- If **Driver Matching** is selected for **Color Correction**, then **Relative Colorimetric** and **Absolute Colorimetric** are not displayed.

Page Setup Tab Description

The **Page Setup** tab allows you to specify the scaling for enlarging or reducing, set the paper feeding method, and more.

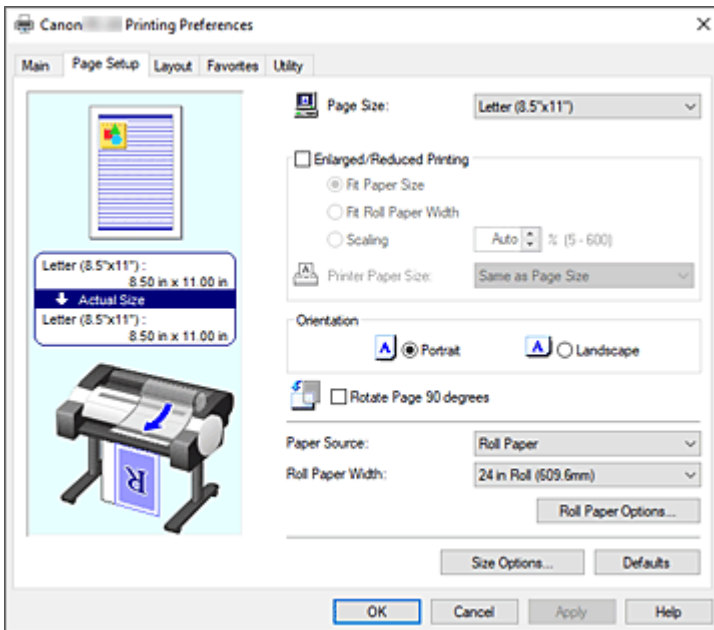

Settings Preview

The paper illustration shows how the original will be laid out on a sheet of paper.

You can check an overall image of the layout.

The printer illustration shows how to load paper to match the printer driver settings.

Check whether the printer is set up correctly by looking at the illustration before you start printing.

Page Size

Selects a page size.

Ensure that you select the same page size as you selected within the application.

When you select **Custom Size** from **Custom Paper Size**, the [Custom Size Settings dialog box](#) appears, and you can specify any vertical and horizontal dimensions for the paper.

Enlarged/Reduced Printing

You can enlarge or reduce a document and then print it.

When you select **Enlarged/Reduced Printing**, you can then set **Fit Paper Size**, **Fit Roll Paper Width**, or **Scaling**.

Fit Paper Size

Enlarge/reduce the document to match the size of the paper to be printed, and then print the document.

Fit Roll Paper Width

You can enlarge/reduce the document to match the roll paper width and then print the document.

When you select this radio button, the **Information** dialog box appears, and you can select **Roll Paper Width**.

Scaling

Enlarge or reduce the document to a specified scale before printing.

Printer Paper Size

When you select **Fit Paper Size**, or **Scaling**, you can specify the setting.
Select the size of the paper to be printed.

Orientation

Selects the printing orientation.

If the application used to create your document has a similar function, select the same orientation that you selected in that application.

Portrait

Prints the document so that its top and bottom positions are unchanged relative to the paper feed direction. This is the default setting.

Landscape

Prints the document by rotating it 90 degrees relative to the paper feed direction.

Rotate Page 90 degrees

Rotate the long edge of the document 90 degrees, match it to the width of the roll paper, and then print the document.

When you print a portrait document onto roll paper, you can save paper by rotating the document 90 degrees and print the document horizontally relative to the paper.

Paper Source

Shows the source from which paper is supplied.

You may be able to switch the paper source with the printer driver.

Roll Paper

Feeds paper using roll paper.

Top Feed

Feeds paper using the cut sheet.

»» Important

- Depending on the media type and size, the **Paper Source** settings that can be selected may differ.

Roll Paper Width

Select the roll paper width.

Select the width that matches the width of the roll paper loaded in the printer.

Roll Paper Options...

Displays the [Roll Paper Options dialog box](#).

You can specify banner printing, and other settings for printing on roll paper.

Size Options...

Displays the [Paper Size Options dialog box](#).

The **Paper Size Options** dialog box allows you to create and register any user-defined paper.

Custom Size Settings dialog box (Paper Size)

This dialog box allows you to specify the size (width and height) of the custom paper.

Paper Size

Specifies the **Width** and the **Height** of the custom paper. Measurement is shown according to the units specified in **Units**.

Units

Select the unit for entering a user-defined paper size.

Roll Paper Options dialog box

You can specify settings for printing on roll paper.

Banner Printing

Select this check box to print documents with several pages as one continuous document. When you do this, the spaces between the pages will be removed.

Paper Size Options dialog box

You can create and register any user-defined paper. You can then select the defined paper size from **Custom Paper Size** of **Page Size**.

Paper Size List

The names and sizes of the paper sizes that the printer driver can use are displayed.

Delete

From **Paper Size List**, you can delete a user-defined paper that a user created.

▶▶▶ Note

- Paper deletion is not possible in the following case:
 - When a standard paper size of the printer driver is selected
 - When an oversized paper size is selected
 - When a paper size with a red circle is selected

Custom Paper Size Name

You can specify the name of a user-defined paper.

Units

You can specify the units for the height and width dimensions of the user-defined paper.

Page Size

You can specify the **Width** and **Height** settings of the paper.

Fix the Ratio of the Width to Height

When you select this check box, you can change the size while keeping the **Width** and **Height** ratio.

Width

Specify the paper width.

Height

Specify the paper height.

Register with the OS

Register the set user-defined paper in the OS.

By registering in the OS, any user sharing the use of the printer or PC can use the set user -defined paper.

Add

You can register a user-defined paper that was set and overwrite the existing user-defined paper.

Display Series

You can narrow down the paper sizes to be displayed in **Paper Size List**.

Oversize

When you select this check box, add appropriate margins so that the document contents will not get cut off, and then print the document.

Layout Tab Description

The **Layout** tab allows you to specify how to arrange the document onto the paper. You can also set the number of copies to be printed and the print sequence. If the application software that you used to create the document features the same functions, specify the settings from the application software.

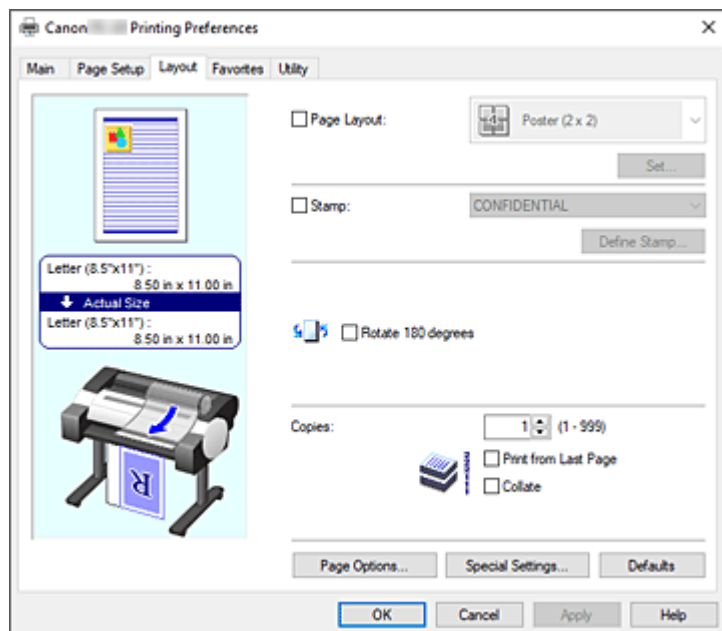

Settings Preview

The paper illustration shows how the original will be laid out on a sheet of paper.

You can check an overall image of the layout.

The printer illustration shows how to load paper to match the printer driver settings.

Check whether the printer is set up correctly by looking at the illustration before you start printing.

Page Layout

Selects the size of the document you want to print and the type of printing.

Poster (1 x 2)/Poster (2 x 2)

Printing is performed with poster settings.

The value in parentheses represents the ratio of the vertical x horizontal lengths. As the number of divisions increases, the number of sheets used for printing increases. If you are pasting pages together to create a poster, increasing the number of divisions allows you to create a larger poster.

Set...

Opens the [Pages to Print dialog box](#).

Specify this setting when you want to print only specific pages.

2 Pages/Sheet / 4 Pages/Sheet / 6 Pages/Sheet / 8 Pages/Sheet / 9 Pages/Sheet / 16 Pages/Sheet

Multiple pages are assigned to one sheet of paper and printed. The number presents the number of pages assigned to one sheet.

Set...

Opens the [Page Layout Printing dialog box](#).

You can freely specify detailed settings for assigned printing.

Edit Using PosterArtist

Word processing and spreadsheet software documents and web browser screens, etc. can be edited a print from PosterArtist.

You must install PosterArtist to use this function. Go to the Canon website, download PosterArtist, and then install it.

Stamp

The **Stamp** function prints a specific character string over the document pages. You can select the characters to be printed from a list or use the **Define Stamp** dialog box to set any characters.

Define Stamp...

Opens the [Define Stamp dialog box](#).

You can specify detailed stamp settings or register any stamp.

Rotate 180 degrees

Rotates document 180 degrees and prints it.

Copies

Specifies the number of copies you want to print. You can specify a value from 1 to 999.

▶▶▶ Important

- If the application used to create your document has a similar function, specify the number of copies with the application without specifying it here.

Print from Last Page

Check this check box when you want to print from the last page in order. If you do this, you do not need to sort the pages into their correct order after printing.

Uncheck this check box to print your document in normal order, starting from the first page.

Collate

Check the check box when you are printing two or more copies, and want to print them in groups.

Uncheck the check box when you want to print them as a group on the same page.

Page Options...

Opens the [Page Options dialog box](#).

You specify settings for printing information such as date, user name, and page number.

▶▶▶ Important

- Depending on your usage environment, you may not be able to use the **Page Options** function. In this case, set **Spooling at Printer Driver** in the [Special Settings dialog box](#) to **Yes**.

Special Settings...

Opens the [Special Settings dialog box](#).

If you are unable to obtain the desired print results, you can change the print processing method.

Pages to Print dialog box

When printing a poster that has been divided into several pages, you can specify which pages to print and just print those pages.

Simply clear the check boxes of the pages you do not want to print.

In the setting view, the pages that were unchecked are hidden, and only the pages to be printed are displayed.

Invert

Switches the pages to be displayed or hidden.

»» Note

- The **Pages to Print** dialog box appears only when **Poster (1 x 2)** or **Poster (2 x 2)** is selected for **Page Layout**.

Page Layout Printing dialog box

This dialog box allows you to select the number of document pages to be placed on one sheet of paper, the page order, and whether a page border line is to be printed around each document page.

The settings specified in this dialog box can be confirmed in the settings preview on the printer driver.

Preview Icon

Shows the settings made on the **Page Layout Printing** dialog box.

You can check what the print result will look like before you actually print the data.

Page Order

Specifies the document orientation to be printed on a sheet of paper.

Page Border

Prints a page border line around each document page.

Select something other than **None** from the list to print the page border line.

»» Note

- The **Page Layout Printing** dialog box appears only when **2 Pages/Sheet**, **4 Pages/Sheet**, **6 Pages/Sheet**, **8 Pages/Sheet**, **9 Pages/Sheet**, or **16 Pages/Sheet** is selected for **Page Layout**.

Define Stamp dialog box

The **Define Stamp** dialog box allows you to specify settings for printing a stamp over the document pages. In addition to the pre-registered ones, you can register and use your original stamp.

Stamps

This is a list of the pre-registered stamps.

Add

Creates an original stamp.

Click this item to set **Name**, **Text**, **Font**, **Style**, **Size**, and **Color**.

Name

Enter the stamp name to be registered.

Text

Enter the characters to be used in the stamp.

Font

Selects the font for the stamp text string.

Style

Selects the font style for the stamp text string.

Size

Selects the font size for the stamp text string.

Color

Select the color of the stamp text string.

Delete

Deletes an unnecessary stamp.

Specify the title of an unnecessary stamp from the **Stamps**, and click this button.

Outline

Selects a frame that encloses the stamp text string.

Print Style

Select the stamp printing method.

Select **Transparent** to print the stamp on the back of the document, and select **Overlap** to print the stamp on the front.

Position

Specifies the stamp position on the page.

You can specify values in **X** and **Y** to set the coordinates, or you can drag the horizontal and vertical slide bars to the left/right or up/down to change the coordinates.

Move to Center

Moves the stamp to the center of the paper.

Angle

Set the stamp positioning angle.

You can specify a value in **Set Angle** to set the angle, or you can drag the slide bar left/right to change the angle.

When specifying an angle value, set a value in the range of -180 to 180.

Stamp first page only

Select this check box if you want to print a stamp only on the first page.

Page Options dialog box

Specify the print settings, such as date, user name, and page number.

Print Date

Select the position for printing the date.

Print Time Also

Prints the time along with the date.

Print User Name

Select the position for printing the user name.

Print Page Number

Select the position for printing the page number.

►►► Note

- It will be displayed if you select **Yes** in **Spooling at Printer Driver** in the **Special Settings** dialog box.

Format Settings

The [Format Settings dialog box](#) opens, and you can set the format.

Format Settings dialog box

Set the format to be used when printing the contents set in the **Page Options** dialog box.

Font

Select the font type.

Style

Select the font style.

Size

Select the font size.

Color

Select the font color.

Special Settings dialog box

The **Special Settings** dialog box allows you to change the print processing method if you do not get the print results you want.

Settings Summary

This is a list of items that you can set in the **Special Settings** dialog box.

When you click an item that you want to set, the setting contents are displayed outside the box.

Spooling at Printer Driver

Set whether print jobs are to be spooled in the print driver or whether PageComposer processing is to be performed.

Setting **No (Use RAW Spooling)** or **Yes** may improve the print results or the printing speed.

Also, depending on the setting, you may not be able to use some of the driver functions.

FineZoom Settings

Use this function to print on long paper.

Yes

The print problem may be corrected.

Select this in usual cases.

No

Image distortions may be corrected (for example, small lines may be eliminated).

Preview Switching

If you check the **Preview before printing** check box on the **Main** tab and then print, PageComposer starts.

Application Color Matching Priority

You can assign higher priority to color management by the application software.

Fast Graphic Process

If image colors or line thicknesses are printed incorrectly, you may be able to get the print results you want by setting this function to off.

This is only displayed when using a 32-bit driver.

Disable the color profile setting of the application software

If the color profile information set in the application software is output to the printer driver, the printing results may include an unexpected tint. You can resolve the problem in this case by setting **Disable the color profile setting of the application software** to **On**.

»» Important

- Even if this is set to **On**, it will only disable some of the color profile information, and it is still possible to print using the color profile.
This should normally be set to **Off** when using.

Adjust Faint Lines

This function prevents thin lines from fading when printing by darkening light colored lines.

Specify Pattern Resolution

This function is for switching the rendering resolution for drawings using the hatch brush or pattern brush.

Cleaner Lines/Text

Set to **Off** if the thickness and density of lines and text are not printed uniformly.

Favorites Tab Description

The **Favorites** tab allows you to register frequently used print settings as favorites.

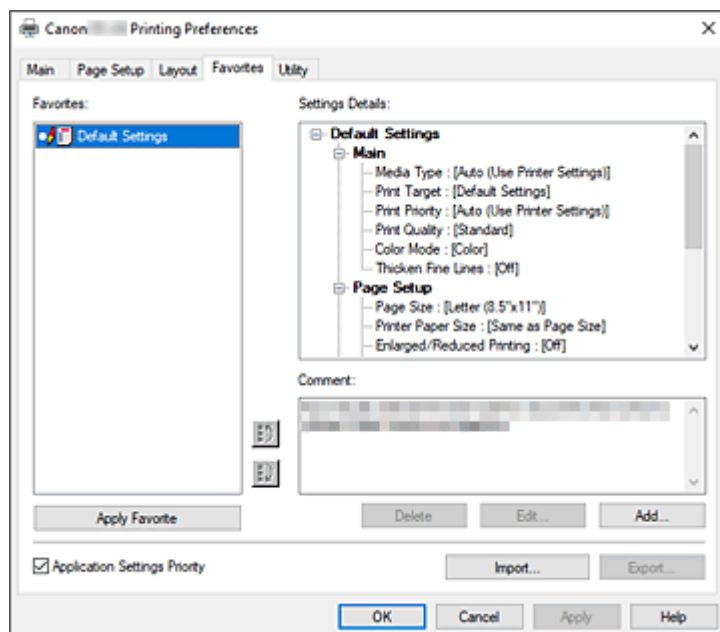

Favorites

A list of the registered favorite settings appears. The Default Settings are registered in the initial settings.

Settings Details

The settings of the favorite that you selected from **Favorites** appear.

Comment

The comment registered to the favorite appears.

Apply Favorite

You can change the print settings to the settings of the favorite that you selected from the **Favorites** list.

Delete

You can delete favorites that have become unnecessary.

Edit...

[The Edit dialog box](#) opens.

You can change the name and icon settings of the favorite that you selected from the **Favorites** list.

Add...

[The Add dialog box](#) opens.

You can register the current settings as a favorite.

Application Settings Priority

The setting in the application software will take priority over the favorites setting set on the printer driver. The setting in the application software is only prioritized for **Page Size**, **Orientation** and **Copies**. Place a checkmark to prioritize the settings for the application software.

Import...

You can read the settings of the favorite that was saved to a file (.cfg).

Export...

You can save the settings of a favorite to a file (.cfg).

Edit dialog box

You can change the name and icon of the favorite that you selected from the **Favorites** list.

Name

Changes name to be displayed in **Favorites** list.

Icon

Changes icon to be displayed in **Favorites** list.

Comment

Changes information to be displayed in **Comment**.

Add dialog box

You can save the current print settings as the settings of a favorite.

Name

Set the name to be displayed in **Favorites** list.

Icon

Set the icon to be displayed in **Favorites** list.

Comment

Enter information to be displayed in **Comment**.

Utility Tab Description

The **Utility** tab allows you to perform printer maintenance or check the settings of the printer.

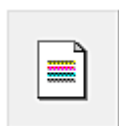
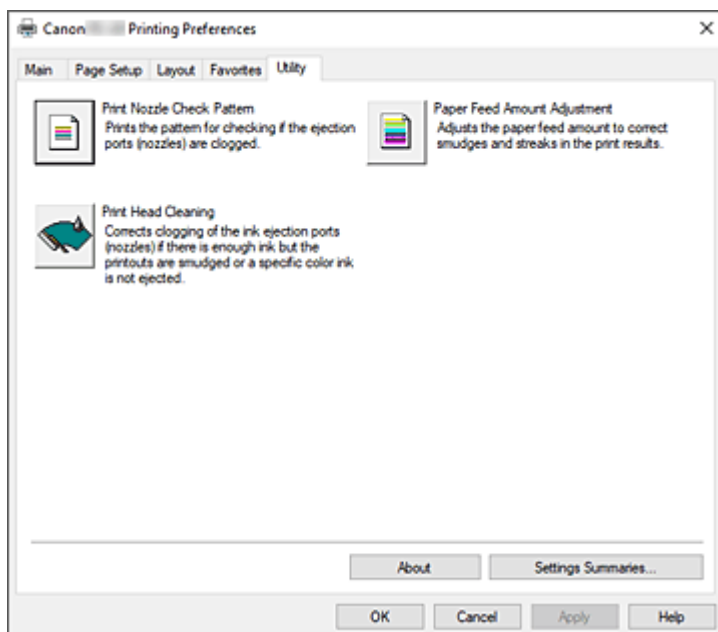

Print Nozzle Check Pattern

Prints a nozzle check pattern.

Perform this function if printing becomes faint or a specific color fails to print. Print a nozzle check pattern, and check whether the print head is working properly.

If the print result for a specific color is faded, or if there are any unprinted sections, use **Print Head Cleaning** to clean the print head.

Paper Source

Displayed using the **Media Type**, **Page Size** and **Roll Paper Width** for each currently set paper feed position.



Print Head Cleaning

Performs print head cleaning.

Print head cleaning removes any blockage in the print head nozzles.

Perform cleaning when printing becomes faint, or a specific color fails to print, even though all ink levels are sufficiently high.



Paper Feed Amount Adjustment

This function adjusts the paper feed amount if the print result is faint or contains streaks.

About

Opens the **About** dialog box.

You can check information such as the version and copyright of the printer driver.

Settings Summaries...

The **Settings Summaries** dialog box is displayed.

You can confirm the list of items set in the printer driver.

If you click the tab of each sheet, you can confirm the setting details of each item.

Related Topics

- ➔ [Cleaning the Print Heads](#)
- ➔ [Printing a Nozzle Check Pattern](#)

Device Settings Tab Description

Many of the tabs in the Properties windows of the printer are controlled by Windows. However, the **Device Settings** tab is for specifying printer configuration-related settings and is part of the printer driver. The **Device Settings** tab allows you to specify settings related to the printer unit, as well as administrator settings.

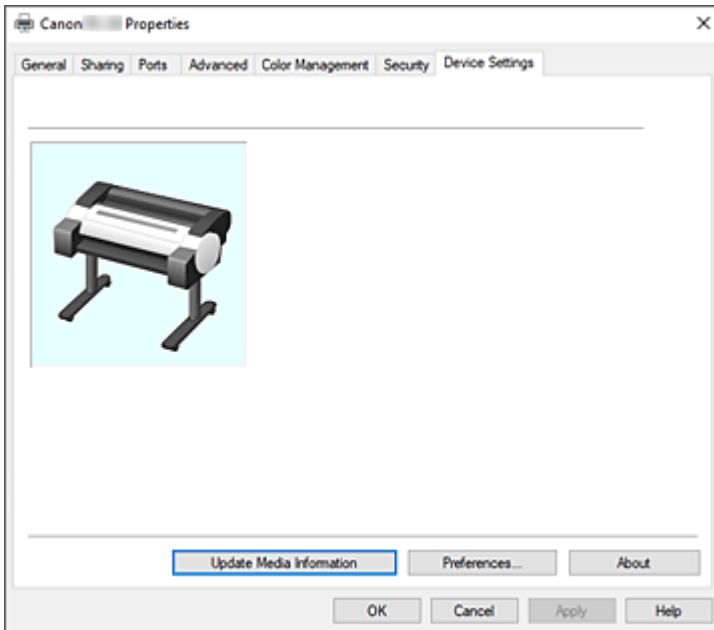

Update Media Information

Opens the **Update Media Information** dialog box.

Gets the latest media information from the printer and updates the media information in the printer driver.

Preferences...

Configure administrator settings for the printer driver.

About

Opens the **About** dialog box.

You can check information such as the version and copyright of the printer driver.

Preferences dialog box

Use System Language

Set this to **On** to change the display language of the printer driver according to the OS language settings.

Canon IJ Status Monitor Description

The Canon IJ Status Monitor displays the status of the printer and the printing progress. The monitor uses graphics, icons, and messages to let you know the printer status.

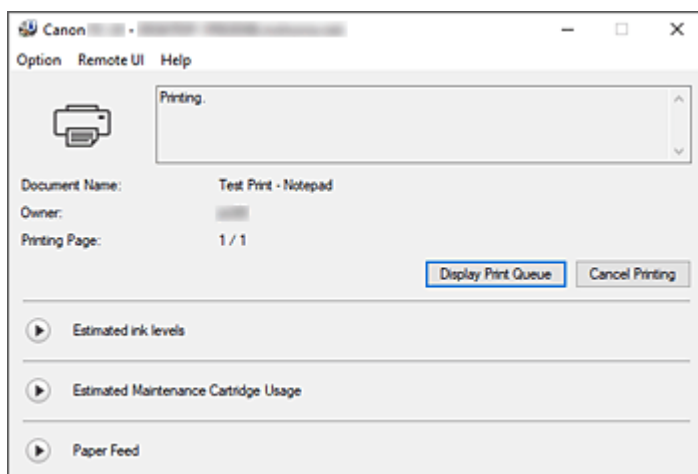

Canon IJ Status Monitor Features

The Canon IJ Status Monitor offers the following advantages:

You can check the status of the printer on the screen.

The status of the printer is shown on the screen in real time.

You can check the printing progress of each printing document (print job).

Error types and solutions are shown on the screen.

Shown when a printer error occurs.

You can immediately check how to respond.

You can check the ink status.

This function displays graphics showing the ink tank type and the estimated ink levels.

Icons and messages are displayed when ink is running low (ink level warning).

Canon IJ Status Monitor Overview

Canon IJ Status Monitor allows you to check the status of the printer and ink with graphics and messages.

You can check the information on the printing document and the printing progress during printing.

When a printer error occurs, it shows the cause and solution. Follow the instruction in the message.

Printer

Canon IJ Status Monitor shows an icon when a warning or error occurs to the printer.



: A warning is being displayed.



: An operation error has occurred.



: You are being informed of remaining ink levels, etc.



: There has been an error which requires a service.

Document Name

Shows the name of the document to be printed.

Owner

Shows the owner's name of the document to be printed.

Printing Page

Shows the number of printing page and total printing pages.

Display Print Queue

Shows the print window used to manage the print job that is being printed or being in the print queue.

Cancel Printing

Cancels the current print job.

Estimated ink levels

Displays icons to report a remaining ink level warning and an ink depletion error.

Click  (the disclosure triangle) to display a pictorial representation of the estimated ink level in the ink tank.

Ink Model Number

You can look up the correct ink tank for your printer.

Estimated Maintenance Cartridge Usage

Displays icons to report that the available space in the maintenance cartridge is low or the cartridge is full.

Click  (the disclosure triangle) to display a pictorial representation of the estimated usage amount in the maintenance cartridge.

Paper Feed

Displays the size and type of paper loaded in each feeder.

Click  (the disclosure triangle) to check the remaining amount of paper.
Purchase information is displayed in **Purchase Paper....**

Option Menu

If you select **Enable Status Monitor**, when a printer related message is generated the Canon IJ Status Monitor starts.

When **Enable Status Monitor** is selected, following commands are available.

Always Display Current Job

Displays the Canon IJ Status Monitor during printing.

Always Display on Top

Displays the Canon IJ Status Monitor in front of other windows.

Display Warning Automatically**When a Low Ink Warning Occurs**

Starts the Canon IJ Status Monitor window automatically and displays it in front of the other windows when a low ink warning occurs.

When a Maintenance Cartridge Warning Occurs

When a maintenance cartridge remaining space warning occurs, the Canon IJ status monitor starts automatically and appears in front of all other windows.

Other Warnings

When any other warning occurs, the Canon IJ Status Monitor will open automatically and be displayed in front of other windows.

Start when Windows is Started

Starts the Canon IJ Status Monitor automatically when you start Windows.

Remote UI menu

You are able to open the printer's Remote User Interface.

You are able to check the printer status and run maintenance functions on the printer when connected to and using it through a network.

Note

- When the printer is being used via USB connection **Remote UI** will not display.

Printer Information

Allows you check detailed information, such as the printer status, the print progress, and remaining ink levels.

Maintenance

Allows you to run printer maintenance and change printer settings.

Job Log

Displays the **Job history** window.

Download Security Certificate

Displays the **For secure communication** window.

This window allows you to download the root certificate, register it to the browser, and disable warning displays.

Help Menu

When you select this menu item, the Help window for Canon IJ Status Monitor is displayed, and you can check the version and copyright information.

Updating the Printer Driver

- **Obtaining the Latest Printer Driver**
- **Deleting the Unnecessary Printer Driver**
- **Before Installing the Printer Driver**
- **Installing the Printer Driver**

Obtaining the Latest Printer Driver

By updating the printer driver to the latest version of the printer driver, unresolved problems may be solved.

You can check the version of the printer driver by clicking the **About** button on the **Utility** tab.

You can access our website and download the latest printer driver for your model.

▶▶ Important

- You can download the printer driver for free, but any Internet access charges incurred are your responsibility.

Related Topics

- ➔ [Before Installing the Printer Driver](#)
- ➔ [Installing the Printer Driver](#)

Deleting the Unnecessary Printer Driver

The printer driver which you no longer use can be deleted.

When deleting the printer driver, first exit all programs that are running.

The procedure to delete the unnecessary printer driver is as follows:

1. Start the uninstaller

Select the **Control Panel** -> **Programs** -> **Uninstall a program (Programs and Features)**.

From the program list, select "XXX Driver" (where "XXX" is your model name) and then click **Uninstall**.

The confirmation window for uninstalling the model appears.

Important

- A confirmation/warning dialog box may appear when starting, installing or uninstalling software. This dialog box appears when administrative rights are required to perform a task. When you are logged on to an administrator account, click **Yes** (or **Continue**, **Allow**) to continue. Some applications require an administrator account to continue. In such cases, switch to an administrator account, and restart the operation from the beginning.

2. Execute the uninstaller

Click **Start**. When the confirmation message appears, click **Yes**.

When all the files have been deleted, click **Complete**.

The deletion of the printer driver is complete.

Before Installing the Printer Driver

This section describes the items that you should check before installing the printer driver. You should also refer to this section if the printer driver cannot be installed.

Checking the Printer Status

- Turn on the printer.

Checking the Personal Computer Settings

- Terminate all running applications.
- Log on as a user who has the administrator account.

Related Topics

- ➔ [Obtaining the Latest Printer Driver](#)
- ➔ [Installing the Printer Driver](#)

Installing the Printer Driver

You can access our web site through the Internet and download the latest printer driver for your model.

The procedure for installing the downloaded printer driver is as follows:

1. Turn on the printer

2. Start the installer

Double-click the icon of the downloaded file.

The installation program starts.

▶▶▶ Important

- A confirmation/warning dialog box may appear when starting, installing or uninstalling software. This dialog box appears when administrative rights are required to perform a task. When you are logged on to an administrator account, click **Yes** (or **Continue**, **Allow**) to continue. Some applications require an administrator account to continue. In such cases, switch to an administrator account, and restart the operation from the beginning.

3. Install the printer driver

Take the appropriate action as described on the screen.

4. Complete the installation

Click **Exit**.

Depending on the environment you are using, a message prompting you to restart the computer may be displayed. To complete the installation properly, restart the computer.

▶▶▶ Important

- You can download the printer driver for free, but any Internet access charges incurred are your responsibility.

Related Topics

- ➔ [Obtaining the Latest Printer Driver](#)
- ➔ [Deleting the Unnecessary Printer Driver](#)
- ➔ [Before Installing the Printer Driver](#)

Application Software

- ▶ **PosterArtist on the Web**
- ▶ **PosterArtist Guide (Windows)**
- ▶ **Direct Print Plus Guide**
- ▶ **Preview Guide (Windows)**
- ▶ **Preview Guide (macOS)**
- ▶ **Free Layout plus Guide (Windows)**
- ▶ **Free Layout Guide (macOS)**
- ▶ **Quick Utility Toolbox Guide**
- ▶ **Wi-Fi Connection Assistant Guide**
- ▶ **Media Configuration Tool Guide**

Handling Paper

- **Loading Rolls in the Printer**
 - Moving the Roll Holder Support
- **Removing the Roll from the Printer**
- **Loading Sheets in the Printer**
- **Paper Settings**
 - Changing the Type of Paper
 - Specifying the Ink Drying Time
 - Specifying the Cutting Method for Rolls
 - Making Margin Settings for Rolls
 - Cutting the Leading Edge of Roll Paper Automatically
 - Reducing Dust from Cutting Rolls
- **Remove Jammed Roll Paper**
- **Remove a Jammed Sheet**
- **Information about Paper**
 - Paper Sizes
 - Paper Information List
 - Updating paper information
 - Using Paper Other Than Genuine Paper and feed confirmed Paper
 - Printing on Paper Other Than Genuine Paper and feed confirmed Paper Using Existing Settings
 - Printing on Paper Other Than Genuine Paper and feed confirmed Paper by Adding a Media Type
- **Managing Paper Information on Printer Using Media Configuration Tool**

Loading Rolls in the Printer

Follow these steps to load rolls in the printer.

⚠ Caution

- Set the roll on its side on a table or other flat surface so that it does not roll or fall. Rolls are heavy, and dropping a roll may cause injury.

➤➤ Important

- Before loading a roll, make sure that the inside of the printer and the output guide are clean. If these areas are dirty, we recommend cleaning them in advance.
 - ➔ [Cleaning Inside the Printer](#)
- When handling the roll, be careful not to soil the printing surface. This may affect the printing quality. We recommend wearing clean cloth gloves when handling rolls to protect the printing surface.
- Cut the edge of the roll paper if it is uneven, dirty, or has tape residue. Otherwise, it may cause feeding problems and affect the printing quality.

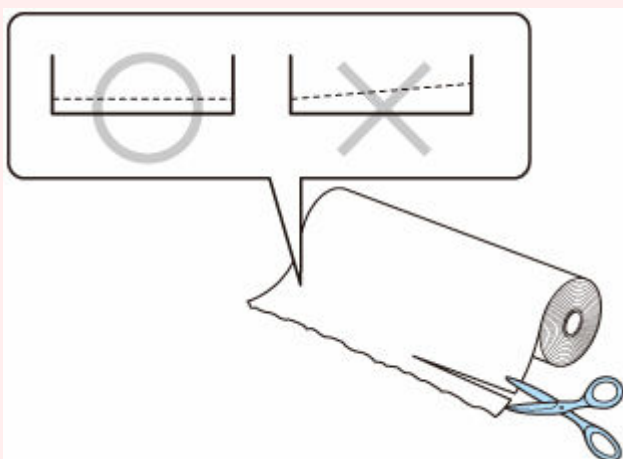

- Align the edges of the paper on both ends of the roll. This may cause feeding problems.

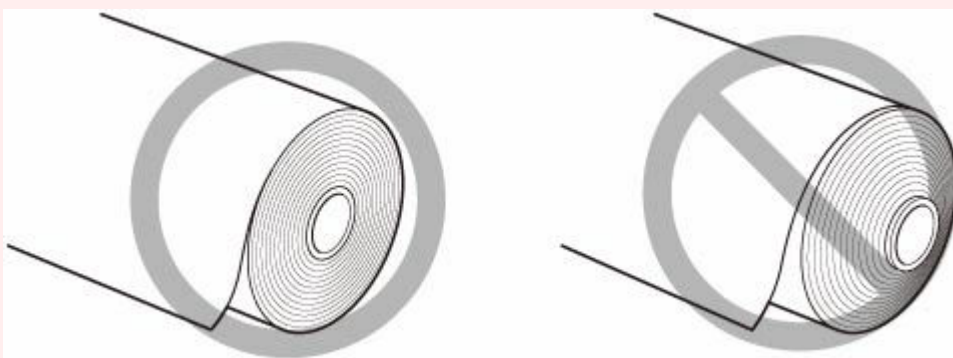

➤➤ Note

- For details on roll paper sizes and types that can be used, see "[Paper Sizes](#)" or "Paper Information List".

1. Select paper settings display area on the Home Screen.

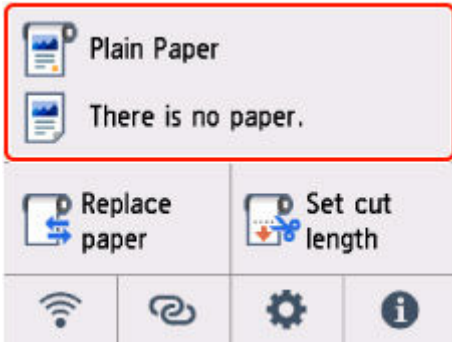

2. Select the roll paper area.

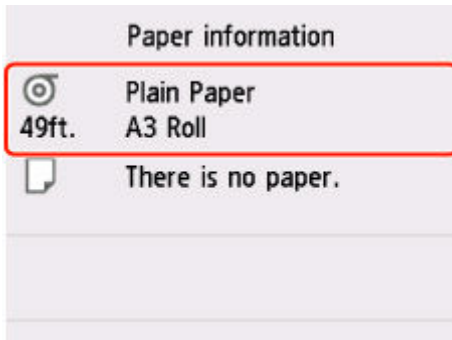

3. Select **Load roll paper** or **Replace paper**.

»» Important

- If paper that will not be used is fed, a message confirming paper replacement is displayed. Follow the instructions on the screen, and then go to the next step.
 - ➔ [Removing the Roll from the Printer](#)
- When the cover is ready to be opened, instructions will be displayed on the touch screen. Do not open the cover before these instructions are displayed.

4. When a message confirming the change of roll paper width is displayed, confirm the contents and select **OK**.

5. Open the cut sheet feed cover.

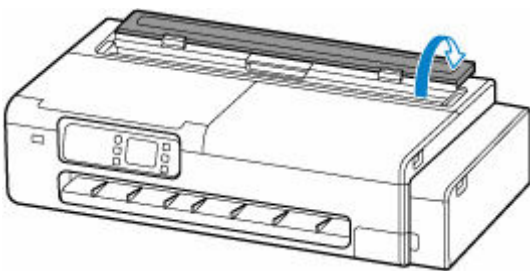

6. Unlock with the lever and open the roll paper feed cover.

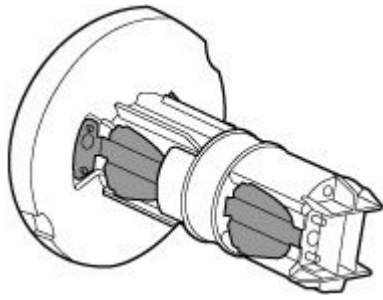

Important

- When loading a roll, be careful to avoid hitting the printer hard with the roll. This may damage the roll holder.

3. Turn the lock lever (B) of the inserted roll holder toward  to lock it.

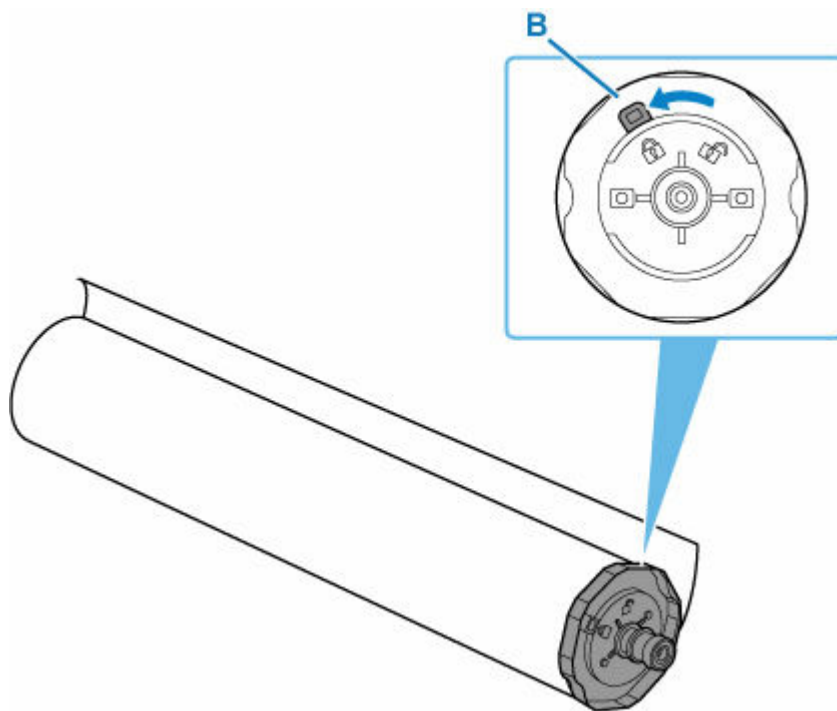

4. Insert the roll holder marked with [L] from the left and press it firmly until the side of the paper roll (C) sits flush against the roll holder with no gap.

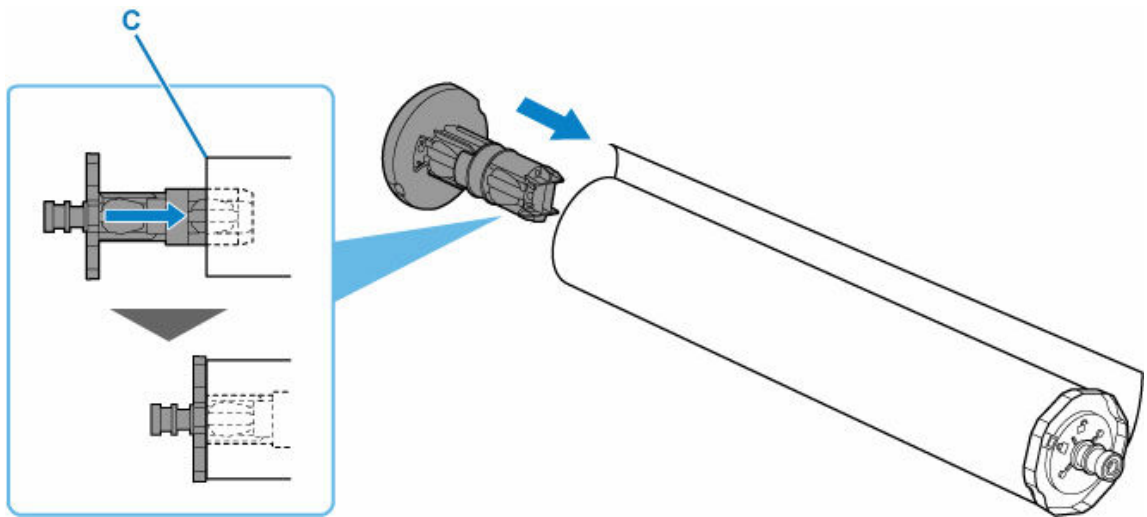

5. Turn the lock lever (D) of the inserted roll holder toward  to lock it.

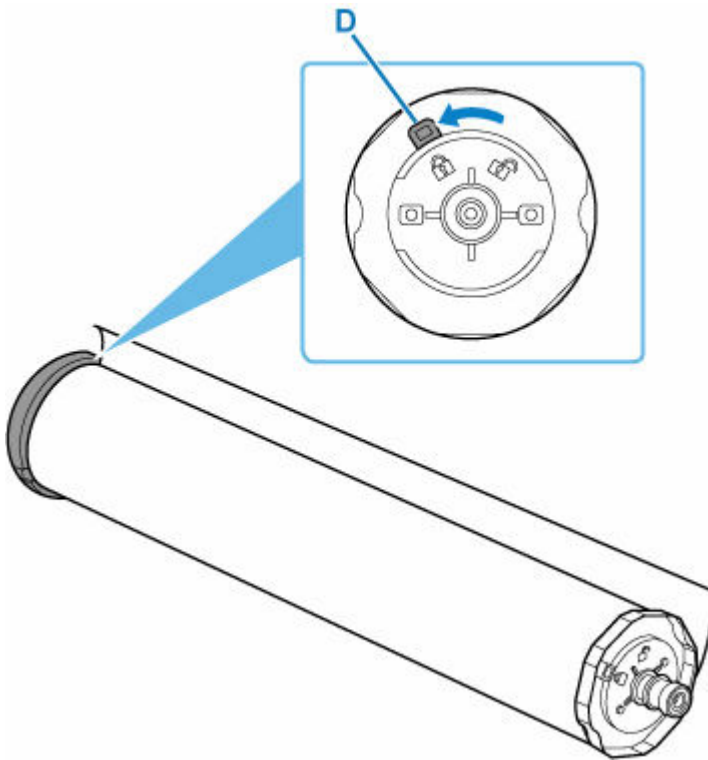

8. If necessary, move the roll holder support to match the width of the roll paper to be loaded.

➔ [Moving the Roll Holder Support](#)

9. Before setting the roll holder, make sure that the roll holder support is firmly fixed.

Depending on your printer, there may be one or two knurled screws.

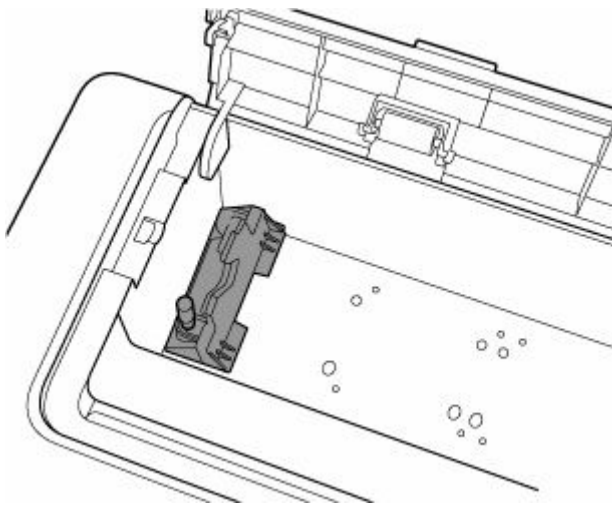

»» Important

- Make sure that the knurled screws on the roll holder support are tightened until they do not turn.

- 10.** Hold the left and right roll holders (E) and place the roll paper on the slide guide (H) so that the roll holder shafts (F) are in front of the roll holder slots (G).

Place the paper roll so that the roll holder marked with [R] is on the right side and the roll holder marked with [L] is on the left side.

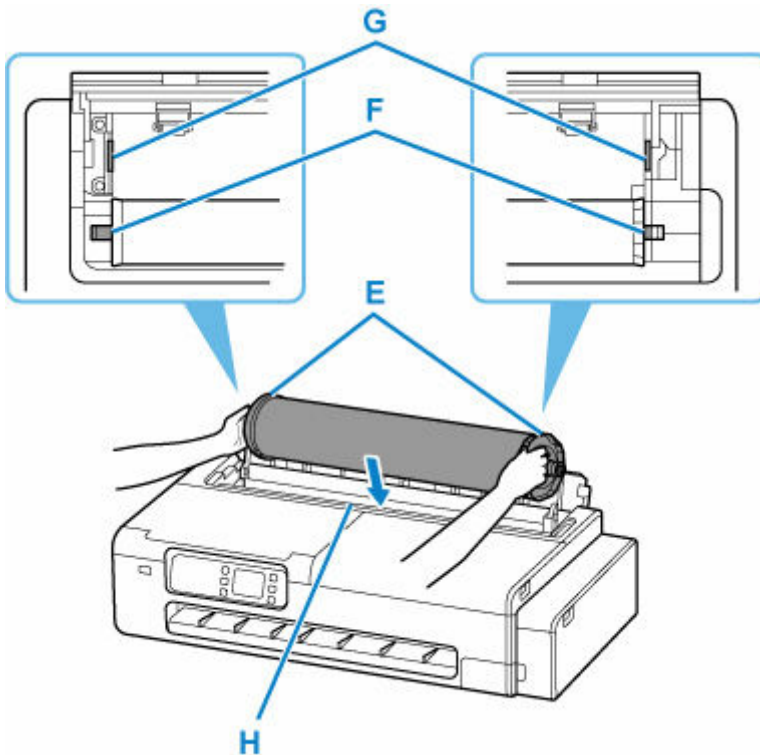

»» Important

- Do not allow roll paper or other materials to come in strong contact with the feed cover rollers located inside the roll paper feed cover. Doing so may result in problems with paper feeding.

11. Set the shafts (F) of the left and right roll holders in the roll holder slots (G) by sliding them on the slide guides (H).

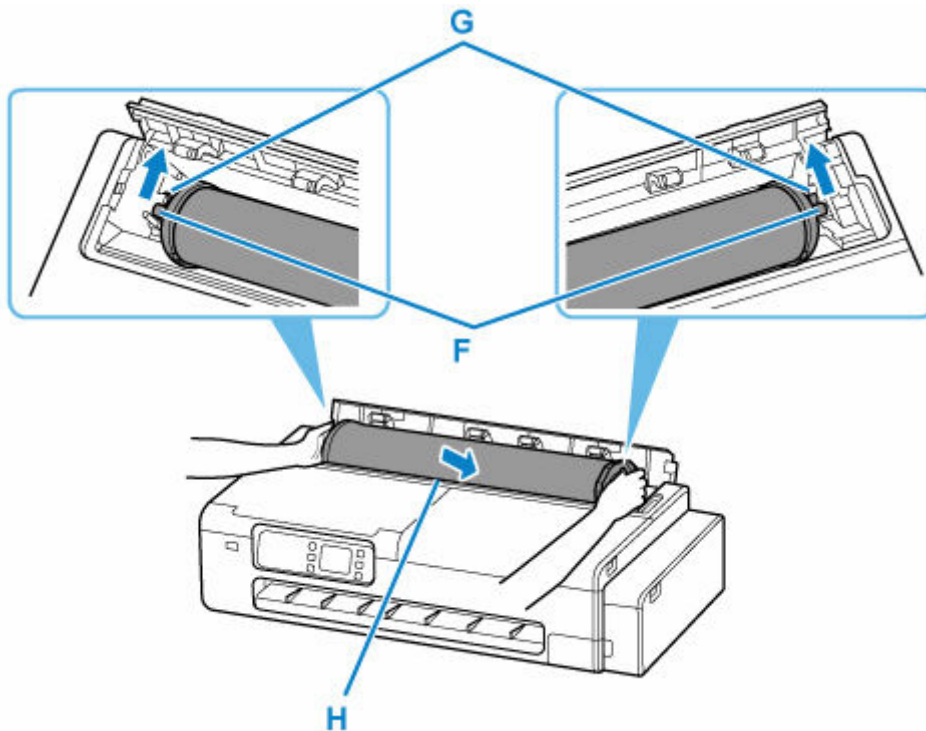

⚠ Caution

- Do not force the roll holder into the printer with the right and left ends reversed. This may damage the printer and roll holder.
- Do not release the roll holder until the holder is loaded in the roll holder slot.
- Be careful not to pinch your fingers between the roll holder shafts (F) and the roll holder slots (G) when loading rolls.

»» Important

- If the leading edge of the roll paper is cut crooked or folded, it may not be fed correctly. Cut the leading edge of the roll paper with scissors or the like and straighten it.
- Load the roll paper so that it is not loaded in the opposite direction.
- If the roll paper has become unwound, remove the slack before loading the roll paper.
- If the paper is wrinkled or warped, straighten it out before loading it.
- Load the roll so that there is no gap between the sides of the roll and the roll holder.

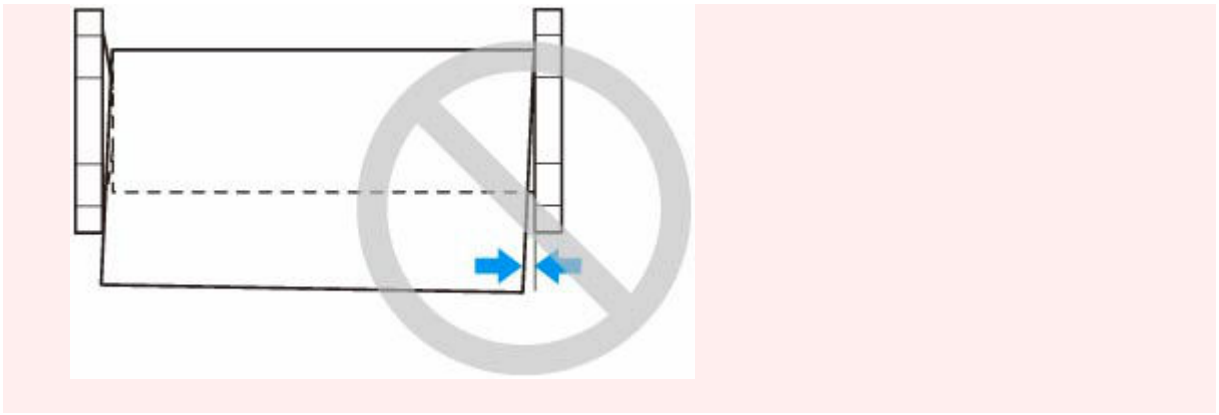

12. Insert the leading edge of the roll into the feed slot (I) and feed it until you hear a sound.

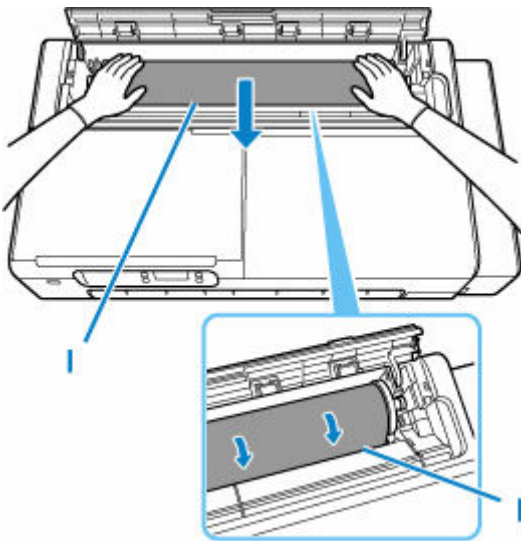

»» Important

- If the leading edge of the paper is stuck to the roll and difficult to insert into the feed slot, pull out the roll slightly before inserting the edge into the feed slot.
- Be careful not to soil the printing surface of roll paper as you insert it in the slot. This may affect the printing quality. We recommend wearing clean cloth gloves when handling rolls to protect the printing surface.

13. Close the roll paper feed cover completely.

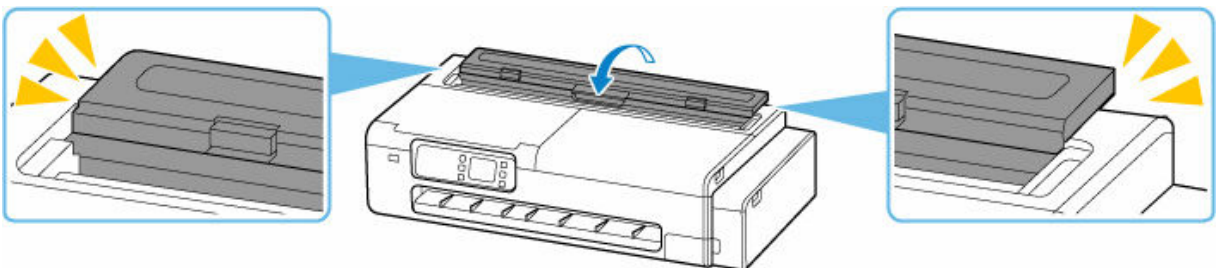

14. Select **OK**.

15. Select the type of paper to use.

After selecting the paper type, paper feeding starts.

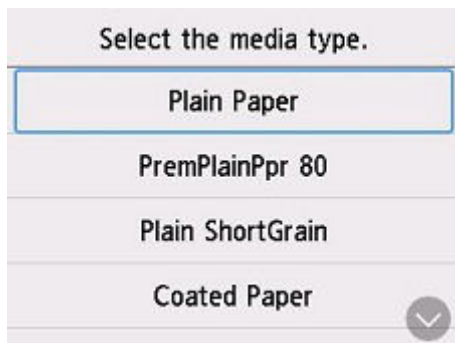

▶▶▶ Important

- Do not open the roll paper feed cover after the paper feeding has started. It may cause paper feeding to fail.
- Cut the edge of the roll using the **Set cut length** function if the edge is creased or soiled.
 - ➔ [Set cut length \(feeds and cuts paper rolls by a specified length\)](#)
- Depending on the type of paper, the paper width may not be detected automatically. Follow the instructions on the screen to manually select the paper size.

▶▶▶ Note

- For details on media types that you can select, see "Paper Information List."
- When selecting **Enable** in **Keep roll paper type**, there is no need to specify the type of the paper.

Moving the Roll Holder Support

To load roll paper of different widths, move the roll holder support as described below.

1. Loosen the knurled screws (A) securing the roll holder support by turning them counterclockwise.

Depending on your printer, there may be one or two knurled screws.

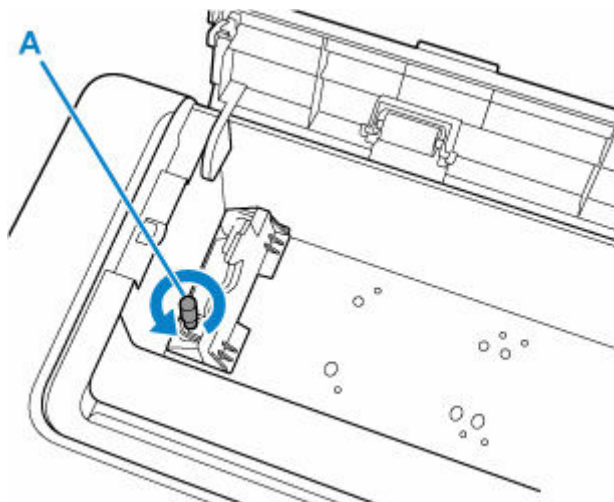

2. Move the roll holder support according to the width of the roll paper to be set.

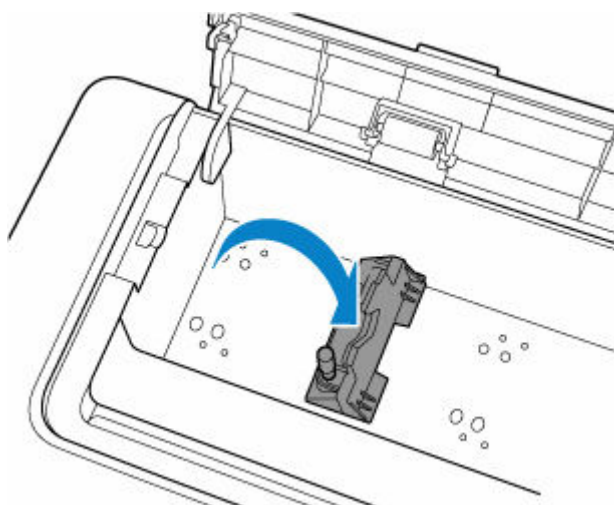

►► Important

- There are holes for the knurling screws at the positions of each support roll paper size. Move the holder to the required position and make sure that the screws are aligned with the holes.

3. Turn the knurled screws (A) clockwise to secure the roll holder support to the printer.

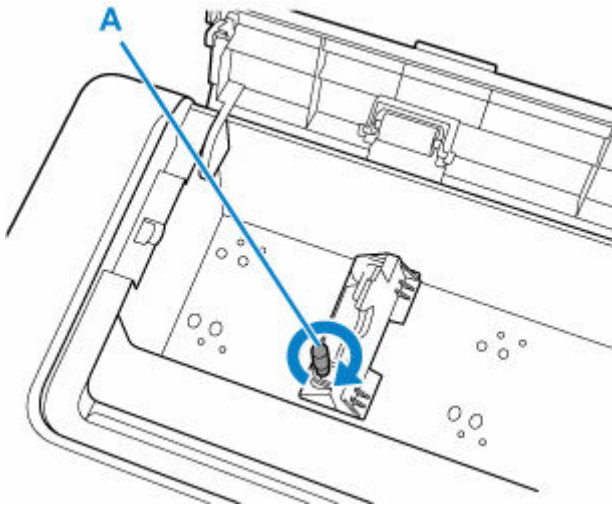

►► Important

- Tighten knurled screws finger-tight until they stop turning. Do not use a screwdriver or similar tool to tighten the screws too tightly.

►► Note

- After moving the roll holder support, continue loading the roll paper.
 - ➔ [Loading Rolls in the Printer](#)

Removing the Roll from the Printer

Remove rolls from the printer as follows.

1. Select paper settings display area on the Home Screen.

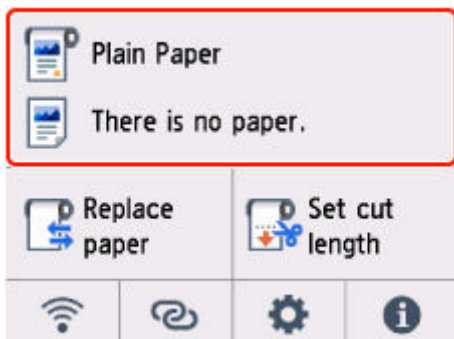

2. Select the roll paper area.

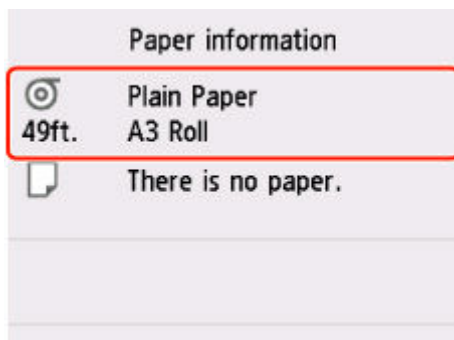

3. Select **Remove paper**.

4. Select **Yes**.

The roll is rewind.

»» Important

- When the cover is ready to be opened, instructions will be displayed on the touch screen. Do not open the cover before these instructions are displayed.

5. Open the cut sheet feed cover.

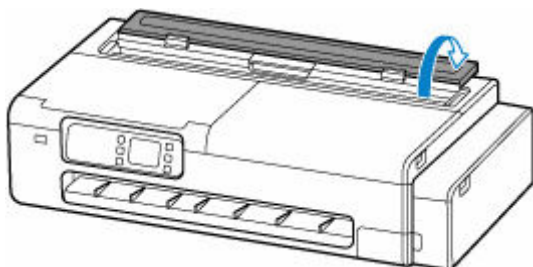

6. Unlock with the lever and open the roll paper feed cover.

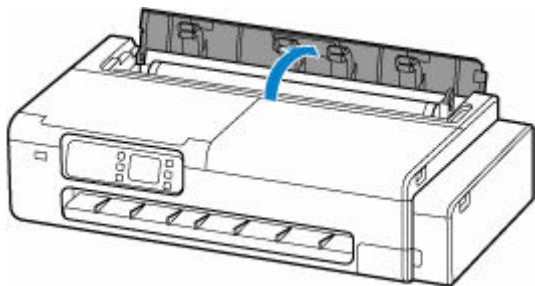

7. Using both hands, rotate the roll holder toward the back to rewind the roll.

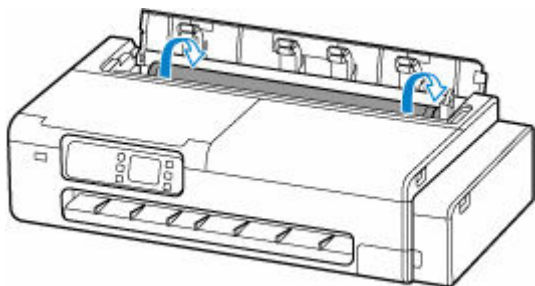

8. Hold the left and right roll holders (A) and remove the roll paper from the printer.

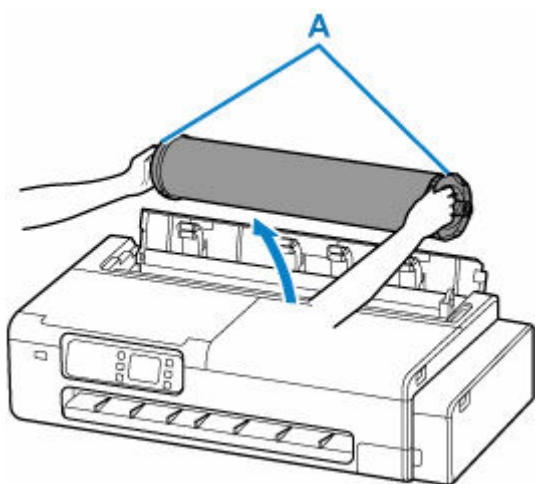

9. Remove the roll from the roll holder.

1. Turn the lock lever (B) on the left roll holder toward  to unlock.

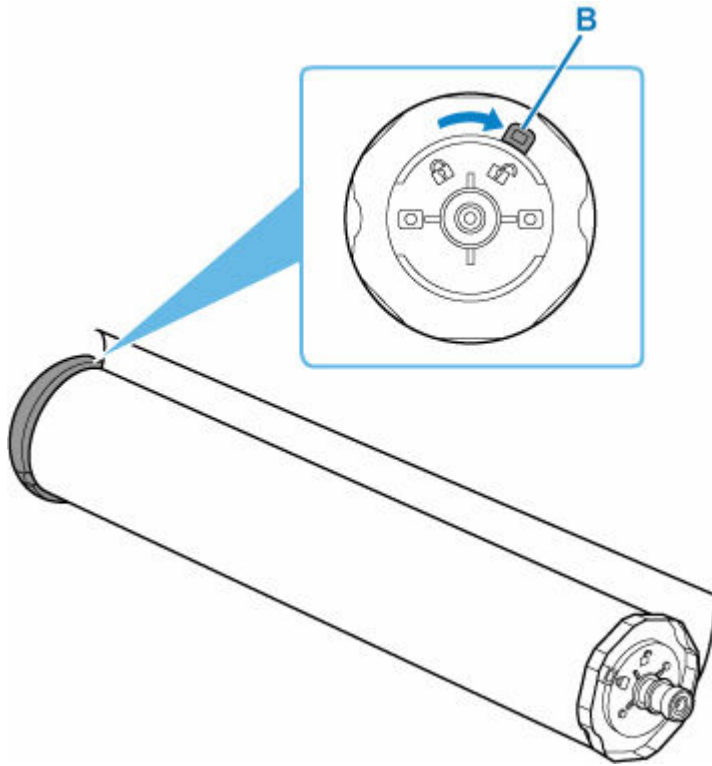

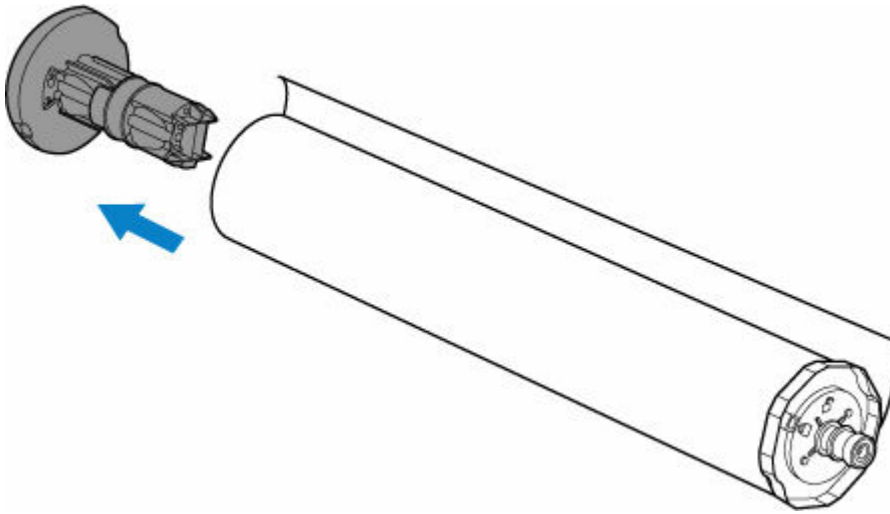

2. Remove the unlocked roll holder from the roll paper.

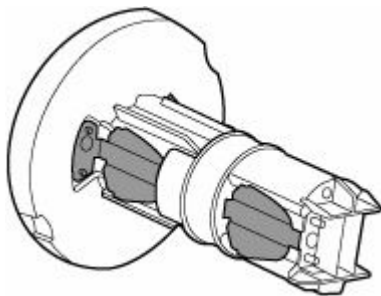

⚠ Caution

- Do not touch the metal part inside the roll holder when removing the roll holder. The sharp edges of the metal may cause injury.



3. Turn the lock lever (C) on the right roll holder toward  to unlock.

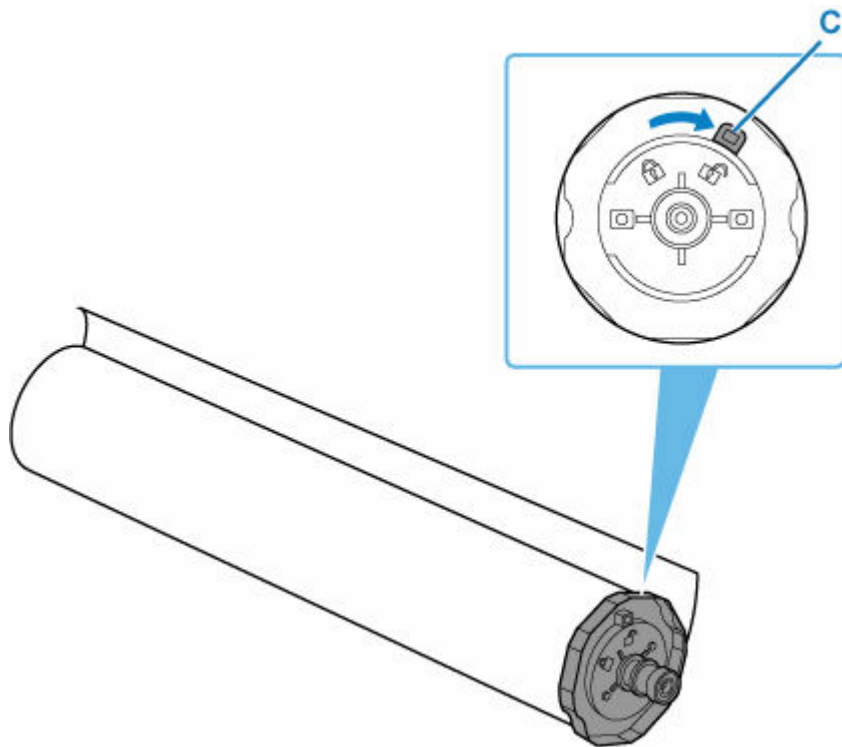

4. Remove the unlocked roll holder from the roll paper.

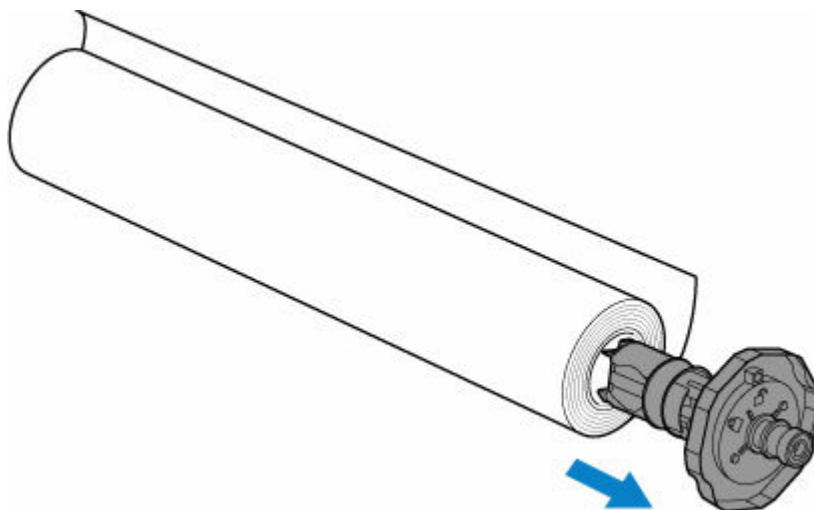

»» Important

- Store the roll in the original bag or box, away from high temperature, humidity, and direct sunlight. If paper is not stored properly, the printing surface may become scratched, which may affect the printing quality when you use it again.

10. Close the roll paper feed cover completely.

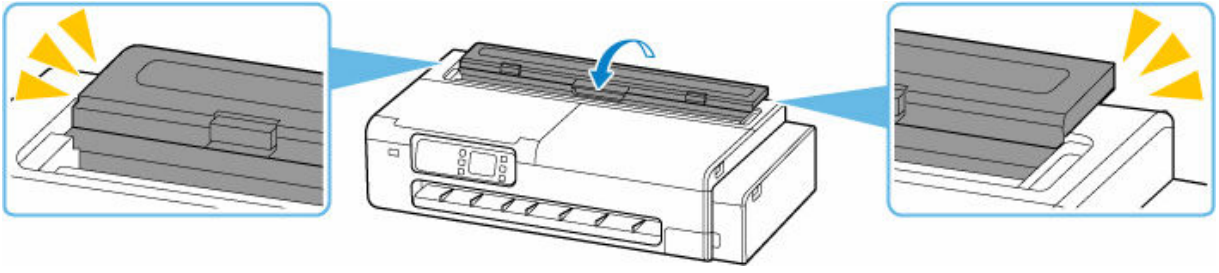

»» Note

- To load new roll paper in the printer at this point, see "[Loading Rolls in the Printer.](#)"

Loading Sheets in the Printer

Follow these steps to load sheets in the printer.

▶▶▶ Important

- Do not load any sheet smaller than A4 size. Doing so may cause a paper jam.

▶▶▶ Note

- For the page size and paper weight you can use for this printer, see [Paper Sizes](#) or Paper Information List.

1. Prepare sheets.

Align the edges of paper. If paper is curled, flatten it.

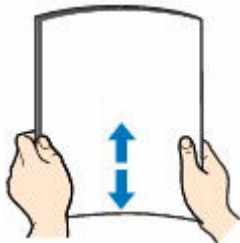

▶▶▶ Important

- Align the edges of paper neatly before loading. Loading paper without aligning the edges may cause paper jams.
- If paper is curled, hold the curled corners and gently bend them in the opposite direction until the paper becomes completely flat.

2. Open the cut sheet feed cover.

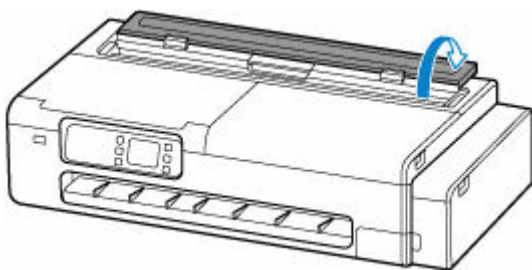

3. Open the top feed and then pull it upwards.

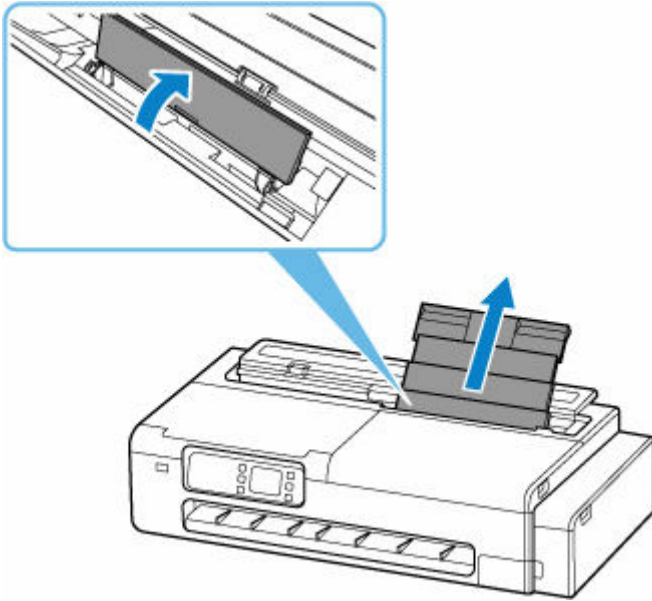

4. Slide the left and right paper guides (A) to open both paper guides.

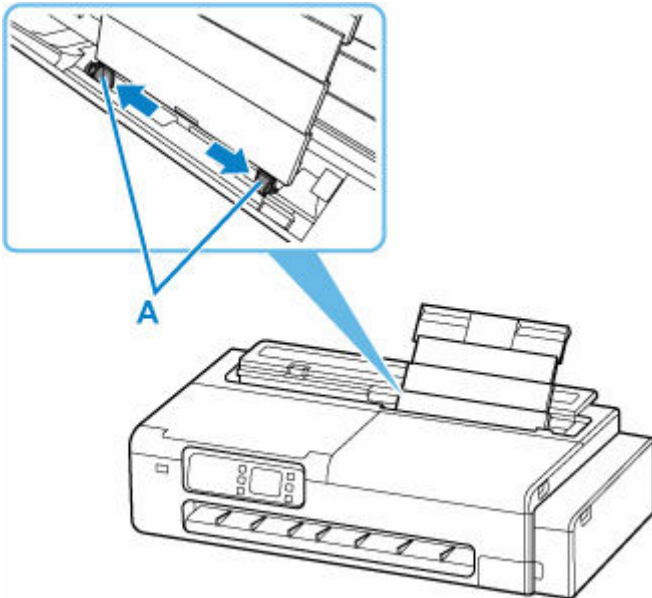

5. Load the sheets in portrait orientation with the print side facing up.

After loading the paper, the paper setting confirmation screen for the top feed appears on the touch screen.

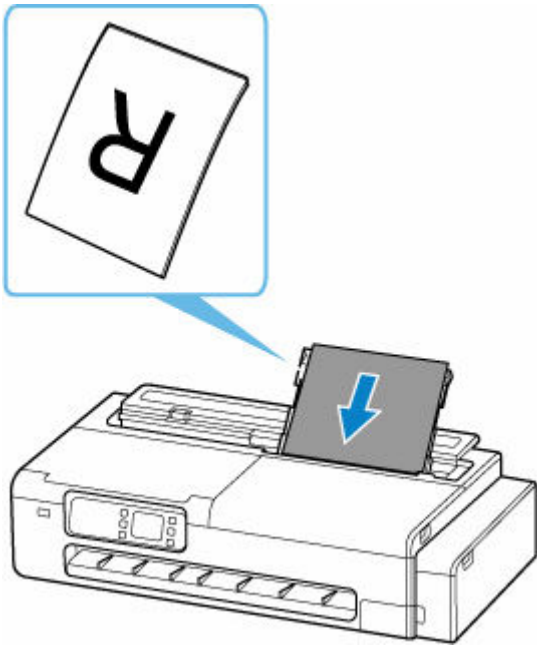

6. Slide the left and right paper guides to align with both sides of the sheets.

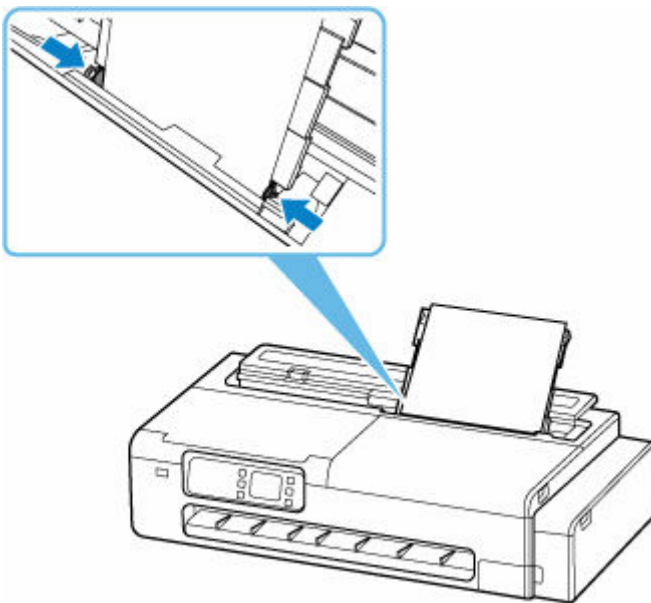

»» Important

- Do not slide the paper guides too hard against the paper. The paper may not be fed properly.
- Always load sheets in portrait orientation. Loading paper in landscape orientation can cause paper jams.
- Do not load sheets of paper higher than the load limit mark (B).

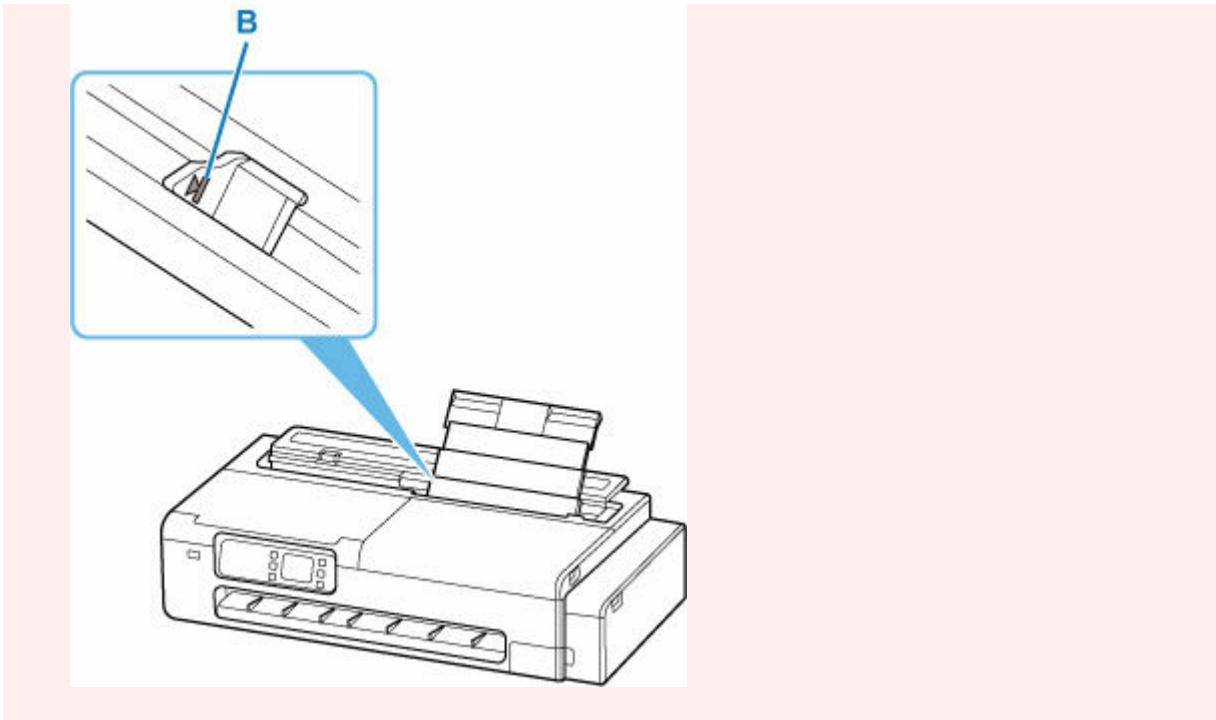

7. If the page size and type displayed on the touch screen match size and type of the sheets loaded in the top feed, select **Yes**.

If not, select **Change** to change the settings in accordance with the size and type of the loaded paper.



»»» Important

- There are many types of paper available, each best suited to a particular printing use. Each media type has specific preset settings (how ink is used and sprayed, distance from nozzles, etc.), that allow you to print to that type with optimal image quality. The wrong paper settings may cause poor printout color quality or scratches on the printed surface.
- For details on media types that you can select, see "Paper Information List".

Paper Settings

- **Changing the Type of Paper**
- **Specifying the Ink Drying Time**
- **Specifying the Cutting Method for Rolls**
- **Making Margin Settings for Rolls**
- **Cutting the Leading Edge of Roll Paper Automatically**
- **Reducing Dust from Cutting Rolls**

Changing the Type of Paper

Follow these steps to change the type of paper specified on the printer after you have loaded paper.

►►► Note

- If you want to continue using the same type of roll paper, set **Keep roll paper type** to **Enable**. The previously selected paper type is automatically selected, saving you the trouble of selecting the paper type when loading the roll paper.

➔ [Keep roll paper type](#)

►►► Important

- For best printing results, the printer fine-tunes the print head height and the feed amount for each type of paper. Be sure to select the type of paper to use correctly before printing.
- Because the printer fine-tunes the paper feed rate and print head height, the margins and the size of printed images may vary depending on the type of paper used. If margins and the size of images are not as you expected, adjust the image quality.

➔ [Adjustments for Better Print Quality](#)

Changing the Type of Paper

1. Select paper settings display area on the Home Screen.

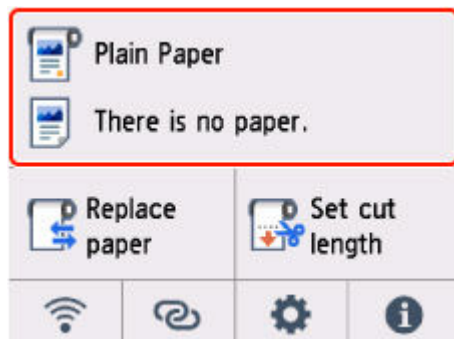

2. Select the roll paper area or sheet area.

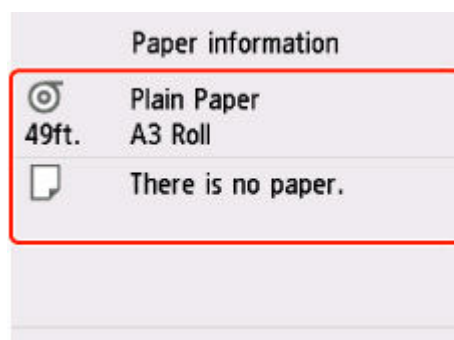

3. Select **Paper settings**.

4. Select **Type**.
5. Select media type of roll paper loaded in printer.

Select the media type.

Plain Paper
PremPlainPpr 80
Plain ShortGrain
Coated Paper 

▶▶▶ Important

- Be sure to select the correct paper type. If this setting does not match the loaded paper, it may cause feed errors and affect printing quality.

▶▶▶ Note

- For details on media types, see "Paper Information List."

6. Select **Register**.

Specifying the Ink Drying Time

When you are using paper that takes longer for ink to adhere, ink may be transferred onto the paper surface during ejection, soiling it. In that case, you may be able to improve the condition by setting the time to wait for the ink to dry after printing.

▶▶▶ Important

- Printer settings are applied when the ink drying time is not set in the printer driver. If the ink drying time is set in the printer driver, that setting has priority.



▶▶▶ Note

- If the cutter touches the print surface on which the ink is not dry, the paper surface may become scratched or soiled, or the paper surface may rub when the paper falls and the surface may become soiled.

To wait for the ink to dry without dropping the printed documents into the basket immediately after printing, set **Cutting mode** to **Eject cut**.

➔ [Specifying the Cutting Method for Rolls](#)

Set on the Printer

1. Select  (Setup) on the HOME screen.
2. Select  **Printer settings**.
3. Select **Paper-related settings**.
4. Select **Advanced paper settings**.
5. Select the paper type for which you want to change the setting.

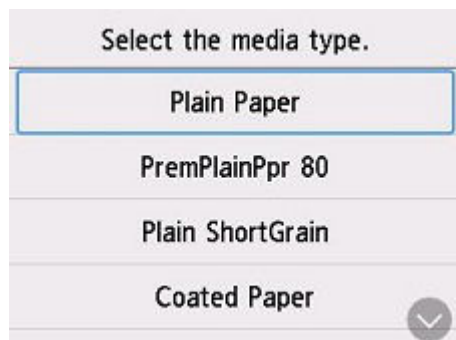

6. Select **Pause between scans** or **Pause between pages**.

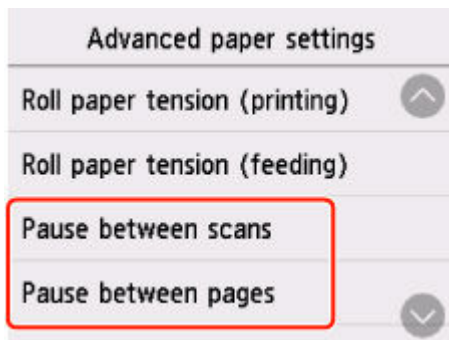

Pause between scans

Specify the waiting time between printing one scan and printing the next one. You can set the drying waiting time and the target area where the waiting time occurs.

Pause between pages

Specify the waiting time between printing one page and ejecting the paper. If there is a next page, it will be printed after the ink drying time has passed.

Set on your Computer

Refer to the followings for how to set from your computer.

- ➔ [Main Tab Description](#) (Windows)
- ➔ [Advanced Paper Settings](#) (macOS)

Specifying the Cutting Method for Rolls

How rolls are cut after ejection varies depending on printer settings.

- **Automatic cut**

The roll is automatically cut by the cutter blade.

- Printer Setting

Cutting mode > Automatic cut

- **Eject cut (when the paper surface is being scratched / to wait for ink to dry)**

Select this to move the cutter by operation panel operation and cut paper. With **Automatic cut**, the paper drops and may rub against the basket, resulting in damage to the print surface, but you can cut using this method and supporting the paper so that it does not drop to avoid damage to the paper. Also, you can prevent paper that has not dried from dropping by visually checking the ink has dried, and then cutting the paper.

After printing is finished, select **Cut paper** to cut the roll.

- Printer Setting

Cutting mode > Eject cut

- **Set cut length (feeds and cuts paper rolls by a specified length)**

The roll paper is fed by the amount specified from the operational panel. The roll paper is always cut after being fed.

Use this function when you want to cut the leading edge of the paper after the roll paper is loaded.

▶▶▶ Note

- For some paper types, the default **Cutting mode** may be set to something other **Automatic cut**. For this paper, we recommend keeping the preset cutting mode.
- If documents printed using **Automatic cut** or **Eject cut** are short, rolls are advanced a specific amount before cutting to prevent problems with cutting and paper ejection. This may create a wider bottom margin, in some cases.

Eject cut (when the paper surface is being scratched / to wait for ink to dry)



▶▶▶ Important

- When cutting wide printed documents after **Eject cut**, have two people support the documents. If the paper drops, printed documents may be damaged.
- Do not lift the paper when holding printed documents before cutting. If the paper rises, it may affect the printing quality or cause rough cut edges.
- After printing is completed, **Eject cut** is possible after the set ink drying time has passed. If 5 minutes have passed without **Eject cut**, the printed document will be cut automatically to protect the printer mechanism.

▶▶ Note

- With **Eject cut**, printing does not resume after a series of jobs have been printed continuously until the roll is cut.

1. Select **Eject cut** in **Cutting mode**.

1. Select  (Setup) on the HOME screen.
2. Select  **Printer settings**.
3. Select **Paper-related settings**.
4. Select **Advanced paper settings**.
5. Select the paper type for which you want to change the setting.

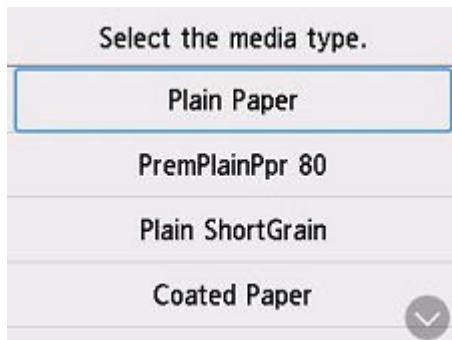

6. Select **Cutting mode**.
 7. Select **Eject cut**.
2. Print the job.

When printing is finished, the printer will stop without cutting.
 3. While holding the printed document from the bottom edge to prevent it from dropping, select **Cut paper** to cut the roll paper.

Set cut length (feeds and cuts paper rolls by a specified length)

1. Select paper settings display area on the Home Screen.

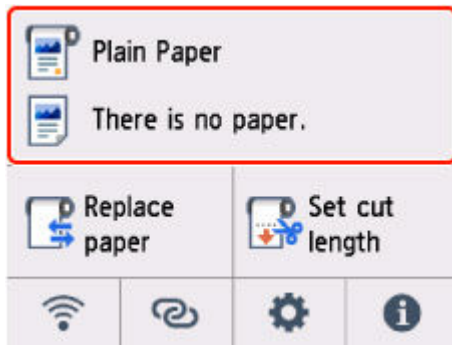

2. Select the roll paper area.
3. Select **Set cut length**.
4. Select the input field and enter the length by which you want to feed the roll paper.

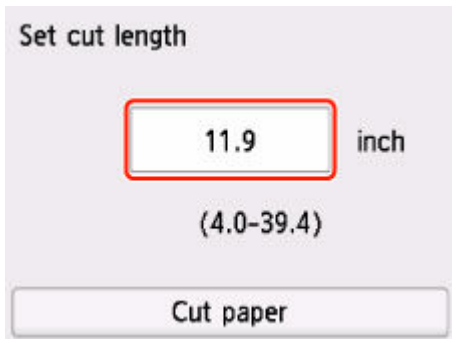

5. Select **Cut paper**.
 6. Select **Yes**.
- The roll paper is cut after the specified length is fed.

Making Margin Settings for Rolls

Make settings related to margins when printing on roll paper. Setting a large margin may improve the image quality of the printed document.

»» Important

- In the printer driver, you can set the margins from **Roll Paper Safety Margin** in the **Paper Detailed Settings** dialog box on the **Main** sheet. If you set from the printer driver, the setting from the printer driver takes priority.

➔ [Main Tab Description](#) (Windows)

Set the Margin Area of the Roll Paper

When printing on roll paper, set the size of margins to add to the top and bottom of the print data.

• Prioritize image size

This setting adds margins to the outside of the print data. Larger margins make the printout longer in the vertical direction and use more paper.

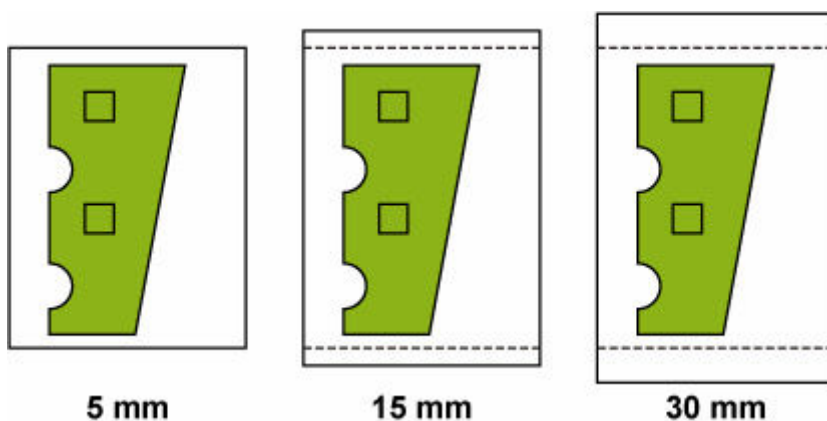

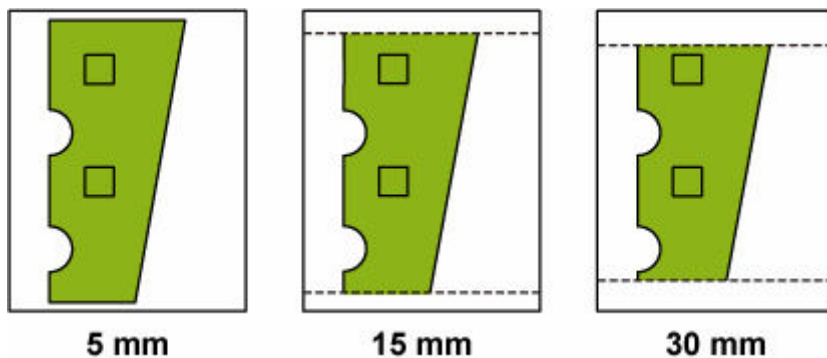

• Prioritize paper size

This setting adds margins to the inside of the print data. Larger margins may cause part of the print data not to be printed.



»» Important

- When using **Prioritize paper size**, **Roll paper lead edge/end margin** may result in part of the image being lost. Prepare your print data to match the printable area.

1. Select  (Setup) on the HOME screen.
2. Select  **Printer settings**.
3. Select **Paper-related settings**.
4. Select **Advanced paper settings**.
5. Select the paper type for which you want to change the setting.

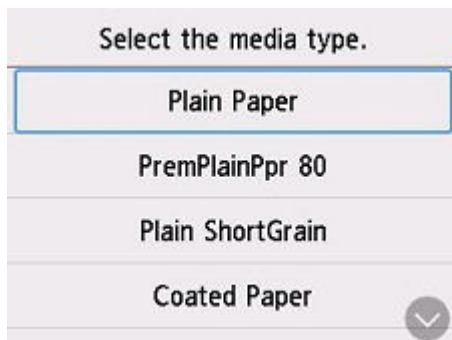



6. Select **Roll paper top/bottom margins**.
7. Select **Prioritize image size** or **Prioritize paper size**.

Set the Margins for the Leading Edge and Far End of the Roll Paper

When printing on roll paper, set the length of the vertical margin in the printing direction. When **Auto** is selected, the margin amount is set according to the paper type and other factors.

»» Important

- Reducing the amount of space may result in the paper becoming dirty.

1. Select  (Setup) on the HOME screen.
2. Select  **Printer settings**.
3. Select **Paper-related settings**.

4. Select **Advanced paper settings**.

5. Select the paper type for which you want to change the setting.

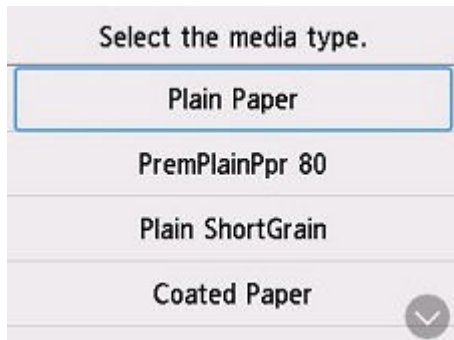

6. Select **Roll paper lead edge/end margin**.

7. Select the margin length you want to set or **Auto**.

Cutting the Leading Edge of Roll Paper Automatically

If the leading edge of the paper is cut crooked or is not cut straight when roll paper is loaded, it will not print correctly. If this happens, you can cut the leading edge of the paper straight when loading a paper roll by using **Trim edge first** in the operation panel menu.

- **Auto**

If the leading edge of the paper is cut crooked and is not cut straight when loading roll paper, cut the leading edge straight and eject the fragment of paper to prevent printing on the platen and soiling the printer.



- **On(Preset Length)**

The amount to cut from the leading edge of the paper varies depending on the media type and is cut to a prescribed length. For the leading edge pre-cut length, see "Paper Information List".

- **On(Input Length)**

The amount to cut from the leading edge of paper is specified in the operation panel. The amount to cut from the leading edge can be specified in the range of lengths displayed in the operation panel. The range of lengths differs according to the media type.

▶▶▶ Note

- The amount to cut from the leading edge of paper cannot be set shorter than the length displayed in the operation panel.

- **Off**

The edge is not cut and scraps are not removed.

1. Select  (Setup) on the HOME screen.

2. Select  **Printer settings**.

3. Select **Paper-related settings**.

4. Select **Advanced paper settings**.

5. Select the paper type for which you want to change the setting.

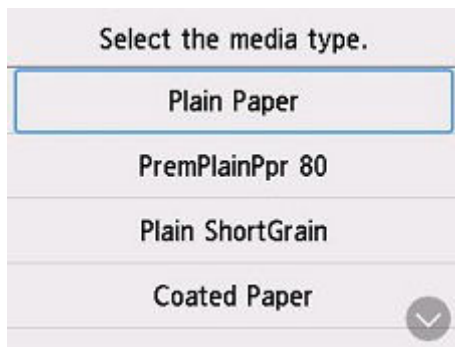

6. Select **Trim edge first**.

7. Select desired **Trim edge first** settings.

This setting takes effect the next time you load a roll.

Reducing Dust from Cutting Rolls

If the paper tends to generate dust when cut, such as with Backlit Film, you can reduce flying dust by setting **Cut-dust reduction** to **ON** from the operation panel menu, which will coat the leading and trailing edges of the printed document with ink. As a result, you can reduce problems with the print head. You can set **Cut-dust reduction** according to the media type.





A: The ink is coated.

B: Cut Position

▶▶▶ Important

- Do not set **Cut-dust reduction** to **ON** for paper that wrinkles easily, such as **Plain Paper** or lightweight paper. If not cut properly, the paper may jam.

1. Select  (Setup) on the HOME screen.
2. Select  **Printer settings**.
3. Select **Paper-related settings**.
4. Select **Advanced paper settings**.
5. Select the paper type for which you want to change the setting.

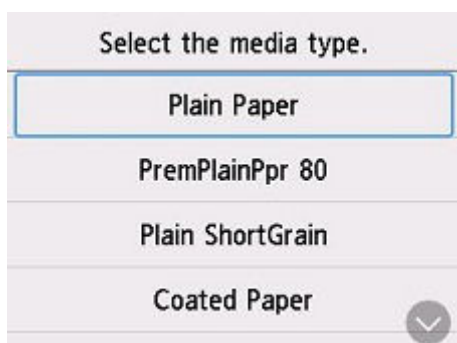

6. Select **Cut-dust reduction**.

7. Select **ON**.

Information about Paper

- **Paper Sizes**
- **Paper Information List**
- **Updating paper information**
- **Using Paper Other Than Genuine Paper and feed confirmed Paper**
 - **Printing on Paper Other Than Genuine Paper and feed confirmed Paper Using Existing Settings**
 - **Printing on Paper Other Than Genuine Paper and feed confirmed Paper by Adding a Media Type**

Paper Sizes

Rolls

Rolls that meet the following conditions are supported.

- Outer diameter: within 4.4 in. (110 mm)
- Inner diameter of paper core: 2 inches
- Printing side out

Roll Paper Width	24 in Roll : 24.00 in. (609.6 mm) A1 Roll : 23.39 in. (594.0 mm) B2 Roll : 20.28 in. (515.0 mm) 18 in Roll : 18.00 in. (457.2 mm) 17 in Roll : 17.00 in. (431.8 mm) A2 Roll : 16.54 in. (420.0 mm) B3 Roll : 14.33 in. (364.0 mm) A3 Roll : 11.69 in. (297.0 mm)
Minimum Paper Length	8.00 in. (203.2 mm)
Maximum Printable Length	13 feet (4 m)
Thickness	3 mil (0.08 mm) to 11 mil (0.28 mm)

Sheets

Sheets of the following sizes are supported.

Sheet Width	8.27 in. (210.0 mm) to 11.69 in. (297.0 mm)
Minimum Paper Length	8.00 in. (203.2 mm)
Maximum Printable Length	17.01 in. (432.0 mm)
Thickness	3 mil (0.08 mm) to 11 mil (0.28 mm)

▶▶▶ Note

- For details on non-standard sizes, see "[Setting Paper Dimensions \(Custom Size\)](#)" (Windows) or "[Setting Paper Dimensions \(Custom Size\)](#)" (macOS).

Updating paper information

You can update the printer's media information to the latest information by applying the latest version of the Media Information File.

For details on the procedure for applying the Media Information File, refer to the following.

➔ [Media Configuration Tool Guide](#)

»» Important

- If you are using the Media Configuration Tool, the new Media Information File is downloaded automatically when released on the Canon website. A computer connected to the Internet is required to download the Media Information File.
- Even if you are not using the printer driver, you should install the Media Configuration Tool in order to register the media types for your region in the printer.

Using Paper Other Than Genuine Paper and feed confirmed Paper

When using this printer to print on paper other than genuine Canon paper and feed confirmed paper, use paper that meets the following conditions.

- Paper where the size is described in "[Paper Sizes](#)"
- Paper where bleeding and ink overflow does not occur when printing
- Paper that does not warp severely when loading the paper or printing

▶▶▶ Note

- For Canon genuine paper/feed confirmed paper, see "Paper Information List."

▶▶▶ Important

- If you use paper other than Canon genuine paper and feed confirmed paper, Canon provides absolutely no guarantees regarding print quality or paper feed properties.

After loading the paper in the printer, select the media type in the operation panel and printer driver and then perform the printing. For the media type, you can select easily from existing settings or you can create and use settings for the paper you are using.

Printing Using Existing Settings

You can print easily by selecting from existing settings provided in the operation panel and printer driver.

➔ [Printing on Paper Other Than Genuine Paper and feed confirmed Paper Using Existing Settings](#)

Printing Using Additional Settings

You can use the function to add custom paper in the Media Configuration Tool to create settings suitable for paper other than genuine paper/output confirmation paper you are using. You can add the created settings to the printer operation panel and printer driver as a new paper type for printing.

➔ [Printing on Paper Other Than Genuine Paper and feed confirmed Paper by Adding a Media Type](#)

Printing on Paper Other Than Genuine Paper and feed confirmed Paper Using Existing Settings

You can easily print on paper other than genuine Canon paper and feed confirmed paper without making complicated settings by selecting the existing settings provided in the operation panel and printer driver depending on the media type you are using. The existing settings consist of general-purpose paper settings provided for different media types.

▶▶▶ Important

- The Canon genuine paper settings provided in the operation panel and printer driver are optimized for Canon genuine paper. If these settings are selected for printing on paper other than Canon genuine paper, the ink may bleed or the print head may rub against the paper. To easily print on paper other than Canon genuine paper and feed confirmed paper, we recommend that you select one of the following general-purpose paper settings.

▶▶▶ Note

- For the available paper types, see "Paper Information List."
- For instructions on selecting the media type with the operation panel, see "[Changing the Type of Paper](#)". For instructions on selecting the media type with the printer driver, see "[Main Tab Description](#)" (Windows) or "Quality & Media" (macOS).

Choosing General-Purpose Paper Settings

These settings anticipate a wide variety of paper other than Canon genuine paper and feed confirmed paper, and, therefore, these settings make it difficult for bleeding ink and print head rubbing to occur. For details on the relationships between the conditions of paper other than Canon genuine paper and feed confirmed paper and the media type to select, see "Paper Information List."

▶▶▶ Note

- If you cannot obtain the desired results by selecting the general-purpose paper settings, use the custom paper adding function in Media Configuration Tool to create settings suitable for the paper you are using. For details, see "[Printing on Paper Other Than Genuine Paper and feed confirmed Paper by Adding a Media Type](#)."

Printing on Paper Other Than Genuine Paper and feed confirmed Paper by Adding a Media Type

Media Configuration Tool provides a function for adding custom paper for better print quality and improved paper feed properties when printing on paper other than Canon genuine paper/feed confirmed paper than when printing with general-purpose settings. You can use this function to configure settings such as the amount of ink used and the height of the print head according to the characteristics of the paper being used, and thereby realize higher print quality. Also, you can add the settings created with this function as a new media type to the operation panel and printer driver.

For details on Media Configuration Tool, refer as follows.

➡ Media Configuration Tool Guide

▶▶ Important

- For details on how to select the added media type in the operation panel, see "[Changing the Type of Paper.](#)"
- You can select the media type to be used in printing from **Media Type** in the **Main** sheet (Windows) or **Quality & Media** (macOS) in the printer driver. For details, see "[Main Tab Description](#)" (Windows) or "Quality & Media" (macOS).
- We recommend that you use an ICC profile created using commercially available profile creation software to perform color management accurately on paper other than Canon genuine paper and feed confirmed paper. You can register the ICC profile you created when creating a custom paper with Media Configuration Tool. See "Adding Custom Paper" in Media Configuration Tool Guide.

Changing Printer's Setting

▶ Changing Settings from Operation Panel

- Home Screen Menu Composition
- Menu Structure
- Setting Items on Operation Panel
- Setting Administrator Password on Operation Panel
- Checking the Total Number of Uses of Printer

▶ Changing Printer's Setting Using Web Browser

- Start up Remote UI
- Changeable Setting Items Using Remote UI
- Setting Passwords Using Remote UI
- Registering Printer's Root Certificate to Web Browser for SSL Communication
- Registering Printer's Root Certificate to Local Computer for SSL Communication
- Generating Server Certificate
- Setting Mail Server
- Specifying Mail Setting for Sending Scanned Data
- Receiving Printer Status by E-mail

Changing Settings from Operation Panel

- **Home Screen Menu Composition**
- **Menu Structure**
- **Setting Items on Operation Panel**
- **Setting Administrator Password on Operation Panel**
- **Checking the Total Number of Uses of Printer**

Home Screen Menu Composition

After the printer starts up, the HOME screen appears on the touch screen.

From the HOME screen, you can check the printer status and select the maintenance, paper operations, settings, and other menus.

➔ [Basic Touch Screen Operations](#)

TC-20M

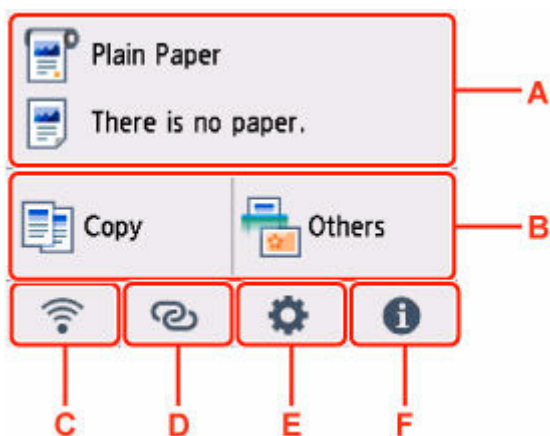

TC-20

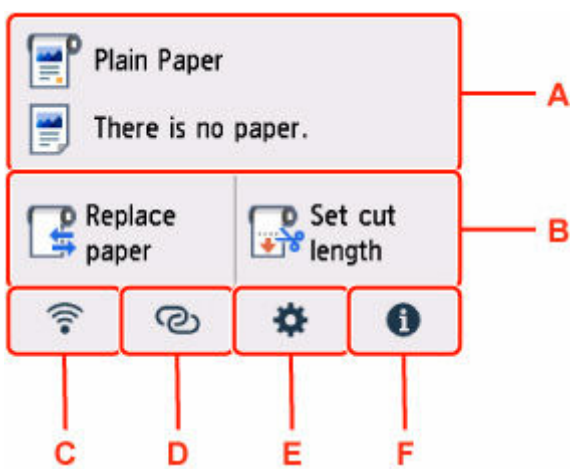

A: Paper Setting Display Area

Displays information on loaded paper. Selecting this option displays the menu for making paper settings.

B: Basic Menu

- For TC-20M

Selects this option when copying or scanning using the printer's operation panel.

- For TC-20

The frequently used **Load paper / Replace paper** and **Set cut length** are displayed here.

C: Network

Displays the current network status. Select to display the basic network information or to change the network settings.

The icon differs depending on the network of use or the network status.



Wi-Fi is enabled and the printer is connected to the wireless router.

▶▶▶ Note

- Depending on the signal state, the icon will change.



(Signal strength: 81 % or more): You can use the printer over a Wi-Fi without any problems.



(Signal strength: 51 % or more): The problem such as the printer cannot print may occur according to the network status. We recommends placing the printer near the wireless router.



(Signal strength: 50 % or less): The problem such as the printer cannot print may occur. Place the printer near the wireless router.



Wi-Fi is enabled but the printer is not connected to the wireless router.



Wired LAN is enabled.



Wireless Direct is enabled.



Wi-Fi and Wired LAN are disabled.

D: Wireless connect

Select to connect the printer to a smartphone/tablet over Wi-Fi through Easy wireless connect.

Select this button to display a confirmation screen for starting a connection. Touch and hold this button to switch to the standby mode for Easy wireless connect.

➔ [Easy wireless connect](#)

E: Setup

Displays the printer's setting menus or the maintenance menus.

F: Information

Displays quick guides about such procedures as loading paper and troubleshooting and such information as estimated ink level and system information.

▶▶▶ Note

- By default, menu settings apply to all print jobs. However, for settings that are also available in the printer driver, the values specified in the printer driver take priority.

Basic Touch Screen Operations

You can select various functions and settings by gently touching and swiping the touch screen with your fingertip.

►►► Important

- Take the following precautions when operating the touch screen. Otherwise, the touch screen may malfunction or become damaged.
 - Do not forcibly press the touch screen with your finger.
 - Do not press the touch screen with an object other than your finger (such as a ballpoint pen, pencil, fingernail, or other object with a sharp tip).
 - Do not operate the touch screen with wet or dirty hands.
 - Do not place objects on top of the touch screen.
- Do not place a protective film over the touch screen. Removing it can damage the touch screen.

Tap

Gently touch with your fingertip and then release.

Use this when selecting an item on the screen.

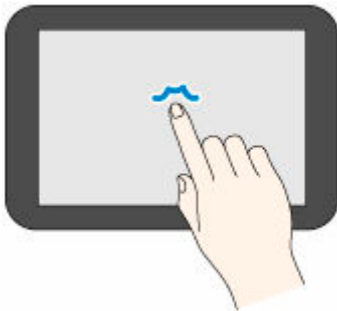

Touch

Gently touch with your fingertip.

To go (or return) to a menu or list, touch the directional mark.

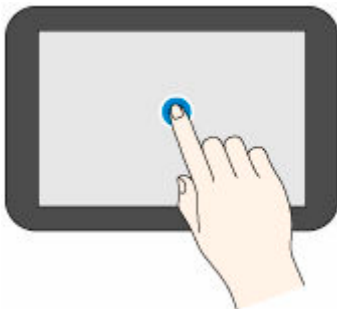

Flick

Drag and release your finger up, down, left, or right.

Use this to quickly scroll through a menu or list.

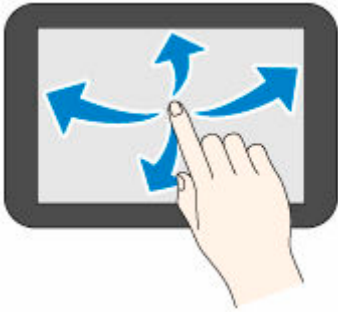

Drag

Move your finger up, down, left, or right while gently keeping it in contact with the touch screen.

Use this to move a menu or list while viewing it.

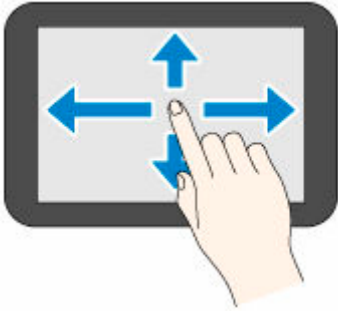

Menu Structure

The * on the right side of an item indicates the default value.

Values may vary depending on your model and firmware version.

- **Paper information**

This menu is displayed by selecting paper information area.

Roll paper settings		
	Load roll paper / Replace paper	
	Set cut length	
	Remove paper	
	Paper settings	
		Type
		Page size
Cut sheet settings		
	Paper settings	
		Type
		Page size

- **Copy (TC-20M only)**

This menu is displayed by selecting **Copy**.

Copy to roll paper		
	Fit to roll width copy	
	Settings	
	Copies	
	Intensity	
		Auto / -4 / -3 / -2 / -1 / Standard* / +1 / +2 / +3 / +4
	Paper src	
		Roll paper
	Type	
	Print qlty	
		High / Standard* / Draft
	Position	
		Portrait* / Landscape
	Enlargement copy	
	(Magnification selection)	
	Settings	

		Copies	
		Intensity	
			Auto / -4 / -3 / -2 / -1 / Standard* / +1 / +2 / +3 / +4
		Paper src	
			Roll paper
		Type	
		Print qlty	
			High / Standard* / Draft
		Position	
			Portrait* / Landscape
Repeat copy			
	Layout		
	Position		
		Portrait* / Landscape	
	Settings		
	Copies		
	Intensity		
		Auto / -4 / -3 / -2 / -1 / Standard* / +1 / +2 / +3 / +4	
	Paper src		
		Roll paper	
	Type		
	Print qlty		
		High / Standard* / Draft	
	Position		
		Portrait* / Landscape	
Scaled copy			
	Settings		
	Copies		
	Intensity		
		Auto / -4 / -3 / -2 / -1 / Standard* / +1 / +2 / +3 / +4	
	Magnif.		
	Paper src		
		Roll paper	
	Page size		
	Type		
	Print qlty		

		High / Standard* / Draft
	Position	
	Portrait* / Landscape	
Frame erase copy		
	Settings	
	Copies	
	Intensity	
	Auto / -4 / -3 / -2 / -1 / Standard* / +1 / +2 / +3 / +4	
	Magnif.	
	Paper src	
	Roll paper	
	Page size	
	Type	
	Print qlty	
	High / Standard* / Draft	
	Position	
	Portrait* / Landscape	

Copy to cut sheet		
	Standard copy	
	Settings	
	Copies	
	Intensity	
	Auto / -4 / -3 / -2 / -1 / Standard* / +1 / +2 / +3 / +4	
	Magnif.	
	Paper src	
	Top feed	
	Page size	
	Type	
	Print qlty	
	High / Standard* / Draft	
Layout copy		
	Settings	
	Copies	
	Intensity	
	Auto / -4 / -3 / -2 / -1 / Standard* / +1 / +2 / +3 / +4	
	Magnif.	

Paper src	
	Top feed
Page size	
Type	
Print qlty	
	High / Standard* / Draft
Layout	
	None / 2-on-1 copy* / 4-on-1 copy
Image stitch copy	
(Original size selection)	
(Paper size selection)	
Settings	
	Copies
	Intensity
	Auto / -4 / -3 / -2 / -1 / Standard* / +1 / +2 / +3 / +4
	Orig. size
	Paper src
	Top feed
	Page size
	Type
	Print qlty
	High / Standard* / Draft
ID card copy	
Settings	
	Copies
	Intensity
	Auto / -4 / -3 / -2 / -1 / Standard* / +1 / +2 / +3 / +4
	Paper src
	Top feed
	Page size
	Type
	Print qlty
	High / Standard* / Draft
Frame erase copy	
Settings	

Copies	
Intensity	
	Auto / -4 / -3 / -2 / -1 / Standard* / +1 / +2 / +3 / +4
Magnif.	
Paper src	
	Top feed
Page size	
Type	
Print qlty	
	High / Standard* / Draft

• **Others (TC-20M only)**

This menu is displayed by selecting **Others**.

Scan	
Save to computer	
Attach to email	
	E-mail from PC
	E-mail directly from device
	Select recipients
	Select from e-mail address book
	Direct entry
	Select from input history
	Edit e-mail address book
	Display e-mail address book
	Import e-mail address book
	Export e-mail address book
	Check send log
	Display send log
	Print send log
Save to USB flash drive	
	Save to USB flash drive
	Delete saved data
Save to cloud	
Save to destination folder	
Print from	
	Print from USB flash drive

Print photos	
	(Number of copies)
Settings	
	Paper src
	Roll paper* / Top feed
	Page size
	Type
	Print qlty
	High / Standard*
	Print date
	ON / OFF*
Print documents	
	(Document selection)
	Copies
	Paper src
	Roll paper* / Top feed
	Page size
	Type
	Print qlty
	High / Standard*
Print from cloud	
Cloud	

- Load paper / Replace paper (TC-20 only)
- Set cut length (TC-20 only)
- LAN settings

This menu is displayed by selecting **Network** icon.

Wi-Fi	
	See settings
Enable/disable Wi-Fi	
	Enable / Disable
Wi-Fi setup	
	Easy wireless connect
	Manual connect
	WPS (Push button method)

		Other connection types
		WPS (PIN code method)
	Advanced	

Wireless Direct		
	See settings	
	Connect to smartphone	
		iPhone/iPad
		Android device
		Others
	Enable/disable Wireless Direct	
		ON / OFF
	Change network name (SSID)	
		OK
		Auto update
		Yes / No
	Change password	
		Change manually
		Auto update
		Yes / No
	Connection request confirmation	
		ON / OFF
	Advanced	

Wired LAN		
	See settings	
	Enable/disable Wired LAN	
		Enable / Disable
	Advanced	

Print details

- **Wireless connect**
- **Setup**

This menu is displayed by selecting **Setup** icon.

Printer settings	
	Print settings
	Prevent paper abrasion

	ON / OFF*
Adjust horizontal print position	
	+3.0 / +2.9 / ... / +0.1 / 0.0* / -0.1 / ... / -2.9 / -3.0
Cleaner Lines/Text	
	Enable* / Disable
IPP print settings	
Print quality settings	
	Color mode
	Color (perceptual) / Color (saturation)* / Color (correct off) / Monochrome / Monochrome BMP
	Print resolution
	Standard* / Print priority
	Print target
	Photo / Line drawing*
Paper settings	
	Unidirectional printing
	ON / OFF*
Default print settings	
Print quality settings	
	Color mode
	Color (perceptual) / Color (saturation)* / Color (correct off) / Monochrome / Monochrome BMP
	Print target
	Photo / Line drawing*
Paper-related settings	
Keep roll paper type	
	Enable / Disable*
Manage remaining roll amount	
	Auto estimate* / Disable
Roll amount warning settings	
	11m/36ft. / 9m/30ft. / 7m/23ft. / 5m/16ft. / 3m/10ft.* / 1m/3ft.
Detect top feed paper change	
	Enable* / Disable
Advanced paper settings	
LAN settings	
* The lower items of this menu are the same as the lower items of LAN settings displayed by selecting Network icon.	

Other printer settings	
Date/time settings	
Date display format	
	YYYY/MM/DD / MM/DD/YYYY / DD/MM/YYYY
Daylight saving time setting	
	ON / OFF*
Sound control	
Keypad volume	
	Loud / Standard* / OFF
Alarm volume	
	Loud / Standard* / OFF
Energy saving settings	
Auto power off	
	Never / 240 min.* / 120 min. / 60 min. / 30 min. / 15 min.
Auto power on	
	ON / OFF*
Time zone	
Original removal reminder	
	ON / OFF*
Keyboard settings	
	Standard* / Full keyboard
Ink level monitor	
Timing for ink level notification	
	Standard* / Earlier notification
Length unit settings	
	Meters / Feet/inches
Language selection	
Firmware update	
Install update	
Check current version	
Update notification settings	
	ON* / OFF
Auto update settings	
	ON / OFF
DNS server setup	
	Auto setup* / Manual setup

Proxy server setup	
	Use / Do not use*
Administrator password settings	
	Change administrator password
	Remove administrator password
Reset settings	
	Web service setup only
	LAN settings only
	Settings only
	Reset paper settings for all paper
	E-mail address book entries only
	Reset all

Maintenance	
Nozzle Check	
	Roll paper
	Top feed
Cleaning	
	All colors
	Color
	BK
Deep Cleaning	
	All colors
	Color
	BK
Print Head Alignment - Auto	
Print Head Alignment - Manual	
	Roll paper
	Top feed
Print the Head Alignment Value	
	Roll paper
	Top feed
Paper feed adjustment	
	Set priority
	(Paper type selection)
	Auto
	Prioritize print quality

		Prioritize length accuracy
Adjust print quality		
	Auto	
		Roll paper
	Manual	
		Roll paper
Adjust feed length		
	Print alignment pattern	
		Roll paper
	Change adjustment values	
		-0.70% / -0.68% / ... / 0.68% / 0.70%
Roller Cleaning		
Bottom Plate Cleaning		
Replace Ink in Print Head		
	All colors	
	Color	
	BK	
Platen cleaning		
Transport mode		
Head Replacement		

Web service setup		
Web service usage registration / Web service usage cancellation		
Web service connection setup		
	IJ Cloud Printing Center setup	
		Register with this service
		Delete from this service
		History setting for this service
	Check Web service setup	
Issue registration code		
DNS server setup		
	Auto setup* / Manual setup	
Proxy server setup		
	Use / Do not use*	

Web service inquiry		
	Print from Canon server	

ECO	
	Auto power off
	Never / 240 min.* / 120 min. / 60 min. / 30 min. / 15 min.
	Auto power on
	ON / OFF*

• **Information**

This menu is displayed by selecting **Information** icon.

Quick guide	
	Loading paper
	Refilling ink tanks
	Using from a smartphone
	Using smartphone apps
	Using Cloud applications
	Learn more about your printer
	Displaying the manual

Estimated ink levels	
	Current estimated ink levels
	How to set
	Ink model no.
	Order ink now

Maintenance cart. info.	
	Maintenance cartridge usage
	Replace

System information	
	Current version
	Printer name
	Serial number
	MAC address (Wi-Fi)
	MAC address (Wired LAN)
	Root cert. thumbprint (SHA-1)
	Root cert. thumbprint (SHA-256)

Troubleshooting	
	Print is smudged or patchy
	Connecting with Wi-Fi

	Paper is jammed
	Other problems
Job management	
	Display job history
	Print job history
	Restrict job history access
Usage stats	
	Total sheets used on the device
	No. of sheets used for copying
	Sheets used for other functions
	Number of sheets scanned

Advanced (Paper settings)

This menu is displayed by selecting the **Setup** icon and then selecting **Printer settings > Paper-related settings > Advanced paper settings**.

Advanced paper settings	
Paper thickness (head height)	
	Auto / High / Standard
Skew detection accuracy	
	Standard / Loose / OFF
Cutting mode	
	Automatic cut / Eject cut
Cut speed	
	Fast / Standard / Slow
Trim edge first	
	Auto / On(Preset Length) / On(Input Length) / Off
Cut-dust reduction	
	ON / OFF
Roll paper tension (printing)	
	High / Standard / Low
Roll paper tension (feeding)	
	High / Standard / Low
Pause between scans	
Ink drying wait time	
	OFF / 0.5 seconds / 1 second
Ink drying target area	
	Overall / Leading edge
Pause between pages	
	OFF / 30 seconds / 1 minute / 3 minutes
Roll paper lead edge/end margin	
	Auto / 5 mm / 15 mm / 30 mm
Roll paper top/bottom margins	
	Prioritize image size / Prioritize paper size
Detect paper width	
	Enable / Disable
Paper core outer diameter	
Paper thickness	

Reset paper settings by paper

Advanced (LAN settings)

This menu is displayed by selecting **Network** icon > **Wi-Fi / Wireless Direct / Wired LAN** > **Advanced**.

The * on the right side of an item indicates the default value.

Advanced	
Set printer name	
TCP/IP settings	
IPv4	
IP address	Auto setup* / Manual setup
DNS server	Auto setup* / Manual setup
Proxy server	Use / Do not use*
IPv6	
Enable/disable IPv6	Enable* / Disable
WSD settings	
Enable/disable WSD	Enable / Disable*
Optimize inbound WSD	Enable* / Disable
WSD scan from this printer	Enable / Disable*
Timeout settings	20 minutes / 15 minutes* / 10 minutes / 5 minutes / 1 minute
Bonjour settings	
Enable/disable Bonjour	Enable* / Disable
Service name	
LPR protocol settings	
	Enable* / Disable
RAW protocol	
	Enable* / Disable
LLMNR	
	Enable* / Disable

IPP settings	
	Enable* / Disable
Wi-Fi DRX settings	
	Enable* / Disable
Wired LAN DRX settings	
	Enable* / Disable
IPsec settings	
	Enable / Disable*
IEEE802.1X/EAP settings	
	Enable/disable
	Enable / Disable*
	Search for EAP router
	Last authentication result

Setting Items on Operation Panel

▶▶▶ Note

- The administrator password is required to change some setting items if it is enabled for changing settings using the operation panel.

➔ [Setting Administrator Password on Operation Panel](#)

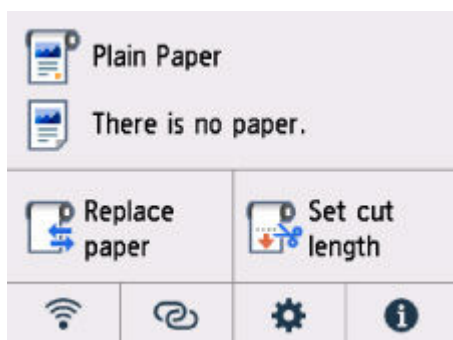

[\(Network\)](#)



[\(Setup\)](#)

- **Printer settings**
 - [Print settings](#)
 - [Paper-related settings](#)
 - [LAN settings](#)
 - [Other printer settings](#)
 - [Language selection](#)
 - [Firmware update](#)
 - **Administrator password settings**
 - ➔ [Setting Administrator Password on Operation Panel](#)
 - [Reset settings](#)
- [Maintenance](#)
- [Web service setup](#)
- [ECO](#)



(Information)

- [System information](#)
- [Job management](#)
- **Usage stats**
 - ➔ [Checking the Total Number of Uses of Printer](#)

Print settings



This item is displayed when you select **Printer settings** from **(Setup)** on the HOME screen.

- **Prevent paper abrasion**

Use this setting only if the print surface becomes smudged.

»» **Important**

- Be sure to set this back to **OFF** after printing since it may result in lower print quality.

- **Adjust horizontal print position**

Adjusts the print position when the left/right margins are not aligned.

You can adjust the left/right margins in increments of 0.004 in. (0.1 mm) between -0.12 in. (-3 mm) and +0.12 in. (+3 mm) centered on the horizontal center of the paper.

»» **Important**

- When using A4/Letter sized paper, the amount of adjustment that can be made is limited. You cannot make adjustments greater than this limit.

- **Cleaner Lines/Text**

When enabled, lines and text are printed more sharply.

- **IPP print settings**

Sets the image quality and paper settings for IPP printing.

For example, when printing using AirPrint or Mopria Print Service, this setting value is applied.

- **Default print settings**

Sets the default values for print settings.

If **Media Type** is set to **Auto (Use Printer Settings)** in the printer driver, this setting value is applied.

Paper-related settings



This item is displayed when you select **Printer settings** from **(Setup)** on the HOME screen.

- **Keep roll paper type**

Select **Enable** to continue using the same type of roll paper.

- **Manage remaining roll amount**

Selects the method to manage remaining roll amount and that to display warning when the roll is running short.

- **Auto estimate**

Estimates and manages the remaining amount of roll paper.

To estimate the remaining roll amount, **Paper thickness** and **Paper core outer diameter** have to be set correctly.

When using a paper that is not listed in the paper information list, set Thickness and Paper Tube Size in **Advanced paper settings** or in Media Configuration Tool.

For paper thickness and paper tube outer diameter size, contact the paper manufacturer.

▶▶▶ Important

- If you do not select the media type correctly, the remaining roll amount may not be estimated correctly.
- There is an error in the estimated remaining roll amount, and paper may run out during printing.

- **Disable**

Select to disable managing remaining roll amount.

- **Roll amount warning settings**

Specifies when to warn the remaining roll paper amount.

▶▶▶ Note

- This setting is enabled when **Auto estimate** is selected for **Manage remaining roll amount**.

- **Detect top feed paper change**

Detects paper insertion into the top feed when **Enable** is selected. When the paper registration screen is displayed after replacing paper, register the paper size and the media type.

- **Advanced paper settings**

Performs advanced paper settings for each media types.

LAN settings



This item is displayed when you select **Printer settings** from **(Setup)** on the HOME screen.

Important

- The administrator password is required to change the settings if it is enabled to change the settings on the operation panel using the administrator password.

- ➔ [Wi-Fi](#)
- ➔ [Wireless Direct](#)
- ➔ [Wired LAN](#)

Wi-Fi

- **See settings**

The network settings information of the printer appears when it is connected by Wi-Fi. (Some setting items are not displayed depending on the printer settings.)

Items	Setting
Connection	Enabled (connected)/Enabled (disconnected)/Disable
Network name (SSID)	XXXXXXXXXXXXXXXXXX XXXXXXXXXXXXXXXXXX (up to 32 characters)
Wi-Fi security	Disable/WPA-PSK (TKIP)/WPA-PSK (AES)/WPA2-PSK (TKIP)/ WPA2-PSK (AES)/WPA3-SAE (AES)/WPA-EAP (AES)*/WPA2-EAP (AES)*/WPA3-EAP (AES)* *Supports IEEE802.1X (EAP-TLS / EAP-TTLS / PEAP)
Signal strength (%)	XXX
IPv4 address	XXX. XXX. XXX. XXX (12 characters)
IPv4 subnet mask	XXX. XXX. XXX. XXX (12 characters)
IPv4 default gateway	XXX. XXX. XXX. XXX (12 characters)
IPv6 link-local address	XXXX: XXXX: XXXX: XXXX: XXXX: XXXX: XXXX: XXXX (32 characters)
MAC address (Wi-Fi)	XX: XX: XX: XX: XX: XX (12 characters)
Printer name	XXXXXXXXXXXXXXXXXX (up to 15 characters)
Bonjour service name	XXXXXXXXXXXXXXXX XXXXXXXXXXXXXXXX XXXXXXXXXXXXXXXX XXXXXXXXXXXXXXXX (up to 48 characters)

("XX" represents alphanumeric characters.)

- **Enable/disable Wi-Fi**

Enables/disables Wi-Fi.

- **Wi-Fi setup**

Selects the setup method for Wi-Fi connection.

- **Easy wireless connect**

Select if you specify the settings of the access point information to the printer directly from a device (e.g. smartphone, or tablet) without operating the wireless router. Follow the on-screen instructions of the connecting device for the setup procedure.

- **Manual connect**

Select when you perform settings for Wi-Fi manually using the operation panel of the printer.

- **WPS (Push button method)**

Select when you perform settings for Wi-Fi using a wireless router supporting a Wi-Fi Protected Setup (WPS) push button method. Follow the on-screen instructions during setup.

- **Other connection types**

- **WPS (PIN code method)**

Select when you perform settings for Wi-Fi using a wireless router supporting a Wi-Fi Protected Setup (WPS) PIN code method. Follow the on-screen instructions during setup.

- **Advanced setup**

For details on each setting item:

➔ [Advanced setup](#)

Wireless Direct

- **Wireless Direct setting list**

The network settings information of the printer appears when it is connected by the wireless direct. (Some setting items are not displayed depending on the printer settings.)

▶▶▶ Note

- To show or hide the password, select **Show password/Hide password** in the **Wireless Direct setting list** screen.

Items	Setting
Connection	Enable/Disable
Network name (SSID)	DIRECT-XXXXXXXXXX XXXXXXXXXXXXXXXXXXXX (up to 32 characters)
Password	XXXXXXXXXXXX (10 characters)
Wi-Fi security	WPA2-PSK(AES)
No. of printers connected now	XX/XX
IPv4 address	XXX. XXX. XXX. XXX (12 characters)
IPv4 subnet mask	XXX. XXX. XXX. XXX (12 characters)
IPv4 default gateway	XXX. XXX. XXX. XXX (12 characters)

IPv6 link-local address	XXXX: XXXX: XXXX: XXXX: XXXX: XXXX: XXXX: XXXX (32 characters)
MAC address (Wi-Fi)	XX: XX: XX: XX: XX: XX (12 characters)
Printer name	XXXXXXXXXXXXXXXXXXXX (up to 15 characters)
Bonjour service name	XXXXXXXXXXXXXXXXXXXX XXXXXXXXXXXXXXXXXXXX XXXXXXXXXXXXXXXXXXXX XXXXXXXXXXXXXXXXXXXX (up to 48 characters)

("XX" represents alphanumeric characters.)

- **Connect to smartphone**

Enables to connect the smartphone to the printer by reading the QR code displayed on the touch screen with the smartphone, or also by manually obtaining the network name and password.

- **Enable/disable Wireless Direct**

Enables/disables Wireless Direct.

- **Change network name (SSID)**

Changes the identifier (SSID/the printer's name displayed on a Wi-Fi Direct compatible device) for Wireless Direct.

- **Change password**

Changes the password for Wireless Direct.

- **Connection request confirmation**

Selecting **ON** displays the confirmation screen when a Wi-Fi Direct compatible device is connecting the printer.

- **Advanced setup**

For details on each setting item:

➔ [Advanced setup](#)

Wired LAN

- **Wired LAN setting list**

The network settings information of the printer appears when it is connected by wired LAN. (Some setting items are not displayed depending on the printer settings.)

Items	Setting
Connection	Enabled (connected)/Enabled (disconnected)/Disable
IPv4 address	XXX. XXX. XXX. XXX (12 characters)
IPv4 subnet mask	XXX. XXX. XXX. XXX (12 characters)
IPv4 default gateway	XXX. XXX. XXX. XXX (12 characters)
IPv6 link-local address	XXXX: XXXX: XXXX: XXXX: XXXX: XXXX: XXXX: XXXX (32 characters)

MAC address (Wired LAN)	XX:XX:XX:XX:XX:XX (12 characters)
Printer name	XXXXXXXXXXXXXXXXXX (up to 15 characters)
Bonjour service name	XXXXXXXXXXXXXXXXXX XXXXXXXXXXXXXXXXXX XXXXXXXXXXXXXXXXXX XXXXXXXXXXXXXXXXXX (up to 48 characters)

("XX" represents alphanumeric characters.)

- **Enable/disable Wired LAN**

Enables/disables wired LAN.

- **Advanced setup**

For details on each setting item:

➔ [Advanced setup](#)

Advanced setup

- **Set printer name**

Specifies the printer name. You can use up to 15 characters for the name.

➤➤➤ Note

- You cannot use the same printer name as that already used for other LAN connected devices.
- You cannot use a hyphen for the initial or last character of the printer name.

- **TCP/IP settings**

Performs IPv4 or IPv6 setting.

- **WSD settings**

Setting items when you use WSD (one of the network protocols supported in Windows).

- **Enable/disable WSD**

Selects whether WSD is enabled or disabled.

➤➤➤ Note

- When this setting is enabled, the printer icon is displayed on the Network Explorer in Windows.

- **Optimize inbound WSD**

Selecting **Enable** allows you to receive the WSD printing data faster.

- **WSD scan from this printer** (TC-20M only)

Selecting **Enable** allows you to transfer the scanned data to the computer using WSD. To transfer the scanned data, press **Color** button.

▶▶▶ Note

- When you forward the scanned data to the computer searched using WSD, you cannot select the document type.

- **Timeout settings**

Specifies the timeout length.

- **Bonjour settings**

Setting items when you use Bonjour.

- **Enable/disable Bonjour**

Selecting **Enable** allows you to use Bonjour to perform the network settings.

- **Service name**

Specifies the Bonjour service name. You can use up to 48 characters for the name.

▶▶▶ Note

- You cannot use the same service name as that already used for other LAN connected devices.

- **LPR protocol settings**

Enables/disables the LPR setting.

- **RAW protocol**

Enables/disables RAW printing.

- **LLMNR**

Enables/disables LLMNR (Link-Local Multicast Name Resolution). Selecting **Enable** allows the printer to detect printer's IP address from the printer name without a DNS server.

- **IPP settings**

Selecting **Enable** allows you to print via the network with the IPP protocol.

- **Wi-Fi DRX settings**

Selecting **Enable** allows you to activate discontinuous reception when using Wi-Fi (discontinuous reception).

▶▶▶ Note

- Depending on the Wi-Fi router used, discontinuous reception may not be activated even though **Enable** is selected.
- Discontinuous reception is enabled only while the printer is on standby. (The touch screen is in the screen saver mode.)

- **Wired LAN DRX settings**

Selecting **Enable** allows you to activate discontinuous reception when the printer is connected to a device compatible with wired LAN.

- **IPsec settings**

Selecting **Enable** allows you to specify the IPsec security.

- **IEEE802.1X/EAP settings** (Wi-Fi/Wired LAN only)

Setting item when you use IEEE802.1X/EAP.

- **Enable/disable**

Enables/disables IEEE802.1X/EAP.

- **Search for EAP router**

Searches switch/access point of IEEE802.1X/EAP and display it.

- **Last authentication result**

Displays the latest authentication result of IEEE802.1X/EAP setting.

Other printer settings



This item is displayed when you select **Printer settings** from **(Setup)** on the HOME screen.

►► Important

- The administrator password is required to change the settings if it is enabled to change the settings on the operation panel using the administrator password.

- **Date/time settings**

Sets the current date and time.

- **Date display format**

Sets the format of dates displayed on the touch screen and printed on photos.

►► Note

- When **ON** is selected for **Print date** on the print settings screen in printing from a USB Flash Drive, the date is printed in the display format you set.

- **Daylight saving time setting**

Enables/disables the summer time setting. If you select **ON**, you can select additional sub-settings. This setting may not be available depending on the country or region of purchase.

- **Start date/time**

Sets the date and time that summer time starts.

Month: Specify the month.

Week: Specify the week.

DOW: Specify the day of the week.

The screen to set the shift time to start summer time will be displayed after specifying the items above and selecting **OK**.

After specifying the shift time and selecting **OK**, you can specify the end date/time.

- **End date/time**

Sets the date and time that summer time ends.

Month: Specify the month.

Week: Specify the week.

DOW: Specify the day of the week.

The screen to set the shift time to end summer time will be displayed after specifying the items above and selecting **OK**.

Specify the shift time and select **OK**.

- **Sound control**

Selects the volume.

- **Keypad volume**

Selects the beep volume when pressing the touch screen or the buttons on the operation panel.

- **Alarm volume**

Selects the alarm volume.

- **Energy saving settings**

Allows you to turn on/off the printer automatically to save electricity.

- **Auto power off**

Specifies the length of time to turn off the printer automatically when no operation is made or no printing data is sent to the printer.

- **Auto power on**

Selecting **ON** enables the printer to turn on automatically when printing data is sent to the printer.

»» Note

- You can also select this setting by selecting  (**Setup**) on the HOME screen, and then selecting **ECO**.

➔ [ECO](#)

- **Time zone**

Specifies the time zone according to a country or region you live in.

Specifying the time zone to the printer allows you to display the correct time an e-mail was sent from the main unit on your mail software.

- **Original removal reminder (TC-20M only)**

Selects whether the printer will display the reminder screen in case you forget to remove the original from the platen after scanning.

»» Important

- Depending on the type of original or the state of the document cover, forgetting to remove the original may not be detected.

- **Keyboard settings**

Set the keyboard.

Select **Full keyboard** to select the keyboard layout from the following three types.

- **QWERTY**
- **QWERTZ**
- **AZERTY**

- **Ink level monitor**

Sets the timing of the remaining ink level notification.

- **Length unit settings**

Selects the length unit (meter or feet/inch).

Language selection



This item is displayed when you select **Printer settings** from **(Setup)** on the HOME screen.

Changes the language for the messages and menus on the touch screen.

»» Important

- The administrator password is required to change the settings if it is enabled to change the settings on the operation panel using the administrator password.

Firmware update



This item is displayed when you select **Printer settings** from **(Setup)** on the HOME screen.

You can update the firmware of the printer, check the firmware version, or perform settings of a notification screen, a DNS server and a proxy server.

▶▶▶ Important

- The administrator password is required to change settings if it is enabled for changing settings using the operation panel.

▶▶▶ Note

- If LAN is disabled, you cannot use **Install update**, **DNS server setup**, **Proxy server setup**.

- **Install update**

Updates the printer's firmware.

➔ [Firmware update](#)

- **Check current version**

You can check the current firmware version.

- **Update notification settings**

Select **Yes** to display a notification on the touch screen when a firmware update is available.

- **Auto update settings**

Select **ON** to keep the firmware updated to the latest version.

- **DNS server setup**

Performs settings for a DNS server. Select **Auto setup** or **Manual setup**. If you select **Manual setup**, follow the display on the touch screen to perform settings.

- **Proxy server setup**

Performs settings for a proxy server. Follow the display on the touch screen to perform settings.

Reset settings



This item is displayed when you select **Printer settings** from **(Setup)** on the HOME screen. You can set the settings back to the default.

▶▶▶ Important

- The administrator password is required to change the settings if it is enabled to change the settings on the operation panel using the administrator password.
- **Web service setup only**
Sets the Web service settings back to the default.
- **LAN settings only**
Sets the LAN settings back to the default.
- **Settings only**
Returns the settings such as the paper size, media type, or other setting items back to the default. The LAN settings is not returned back to the default.
- **Reset paper settings for all paper**
Selecting **Yes** initializes each setting specified in **Advanced paper settings**.
Entering the administrator password is required if it is enabled.

▶▶▶ Important

- When you set the paper settings back to the factory default, added or updated paper information using Media Configuration Tool is erased.
- **E-mail address book entries only (TC-20M only)**
Deletes all registered e-mail addresses.
- **Reset all**
Sets all settings you made to the printer back to the default. The administrator password specified by Remote UI or Wi-Fi Connection Assistant reverts to the default setting.
After resetting, perform setup again as necessary.

▶▶▶ Note

- You cannot set the following setting items back to the default:
 - The language displayed on the touch screen
 - The current position of the print head
 - The cumulative usage count of this product registered in **Usage stats**.
 - CSR (Certificate Signing Request) for encryption method (SSL/TLS) setting

Maintenance



This item is displayed when you select **(Setup)** on the HOME screen.

- **Nozzle Check**

Prints out the nozzle check pattern.

➔ [Checking for Nozzle Clogging](#)

- **Cleaning**

Select this to clean the print head.

➔ [Cleaning the Print Head](#)

- **Deep Cleaning**

Use this mode if no ink is ejected at all or if **Cleaning** does not solve the problem.

➔ [Deep Print Head Cleaning](#)

- **Print Head Alignment - Auto**

Adjusts the print head position automatically.

➔ [Automatic Adjustment to Straighten Lines and Colors](#)

- **Print Head Alignment - Manual**

Adjusts the print head position manually.

➔ [Manual Adjustment to Straighten Lines and Colors](#)

- **Print the Head Alignment Value**

Prints the print head position adjustment value.

- **Paper feed adjustment**

Adjusts the paper feed amount.

- **Set priority**

Sets how the paper feed rate is adjusted.

- **Auto**

Selects **Prioritize print quality** or **Prioritize length accuracy** automatically according to the printer driver settings.

- **Prioritize print quality**

Adjust to make the horizontal streaks of the printed documents less noticeable. The settings in **Adjust print quality** are applied.

- **Prioritize length accuracy**

Adjusts the length of the ruled lines on the printed documents to match. The values of **Change adjustment values** under **Adjust feed length** are applied.

- **Adjust print quality**

Select this mode when the printed documents have horizontal streaks of different colors.

 - ➡ [Automatically Adjusting Different Colored Horizontal Streaks](#)
 - ➡ [Manually Adjusting Different Colored Horizontal Streaks](#)

- **Adjust feed length**

Select this mode when you want to print ruled lines in CAD drawings to their exact lengths.

 - ➡ [Adjusting Line Length](#)

- **Roller Cleaning**

Select this mode when cleaning the paper feed rollers.

 - ➡ [Cleaning Paper Feed Rollers](#)

- **Bottom Plate Cleaning**

Select this mode when cleaning the inside of the printer.

 - ➡ [Performing Bottom Plate Cleaning](#)

- **Replace Ink in Print Head**

Select this mode when **Deep Cleaning** does not improve the print quality.

 - ➡ Replacing the Ink in the Print Head

- **Platen cleaning**

Select this mode when cleaning the inside of the printer.

 - ➡ [Cleaning Inside the Printer](#)

- **Transport mode**

Select this to prepare for transporting the printer.

 - ➡ [Preparing to Transfer the Printer](#)

- **Head Replacement**

Select this mode when replacing the print head.

 - ➡ [Replacing the Print Head](#)

Web service setup



This item is displayed when you select **(Setup)** on the HOME screen.

- **Web service usage registration / Web service usage cancellation**

Registers/Deletes Web service usage to use the printer device information to/from PIXMA/MAXIFY Cloud Link.

- **Web service connection setup**

The following setting items are available.

- **IJ Cloud Printing Center setup**

Registers/Deletes the printer to/from Canon Inkjet Cloud Printing Center.

- **Check Web service setup**

Make sure whether the printer is registered to Canon Inkjet Cloud Printing Center.

- **Issue registration code**

In order to link the web service and printer, obtain the registration code from the service origin.

- **DNS server setup**

Performs settings for a DNS server. Select **Auto setup** or **Manual setup**. If you select **Manual setup**, follow the display on the touch screen to perform settings.

- **Proxy server setup**

Performs settings for a proxy server. Follow the display on the touch screen to perform settings.

ECO



This item is displayed when you select  (**Setup**) on the HOME screen.

This setting allows you to turn on/off the printer automatically to save electricity.

- **Auto power off**

Specifies the length of time to turn off the printer automatically when no operation is made or no printing data is sent to the printer.

- **Auto power on**

Selecting **ON** enables the printer to turn on automatically when printing data is sent to the printer.

System information



This item is displayed when you select **(Information)** on the HOME screen.

- **Current version**

Displays the current firmware version.

- **Printer name**

Displays the printer name currently specified.

- **Serial number**

Displays the printer serial number.

- **MAC address (Wi-Fi)**

Displays the MAC address for Wi-Fi.

- **MAC address (Wired LAN)**

Displays the MAC address for wired LAN.

- **Root cert. thumbprint (SHA-1)**

Shows the root certification thumbprint (SHA-1) of the printer.

- **Root cert. thumbprint (SHA-256)**

Shows the root certification thumbprint (SHA-256) of the printer.

Job management



This item is displayed when you select **(Information)** on the HOME screen.

- **Display job history**

Displays the job history of **Print from / Copy / Communication log**.

- **Print job history**

Prints the job history of **Print from / Copy / Communication log**.

- **Restrict job history access**

This is the menu for the developer.

Setting Administrator Password on Operation Panel

The administrator password can be set or canceled.

»» Important

- The administrator password is set at time of purchase. The default password is the printer serial number (9 characters) which can be found on the sticker on the printer.



1. Select **(Setup)** on the HOME screen.

➔ [Home Screen Menu Composition](#)



2. Select **Printer settings**.

3. Select **Administrator password settings**.

If you have set an administrator password, enter the password.

4. Select **Change administrator password**.

5. Select the effective range of the administrator password.

Remote UI and other tools

To change the setting using the remote UI or a certain software, the administrator password needs to be entered.

LCD, Remote UI, and other tools

To change the setting using the operation panel of this printer, remote UI or a certain software, the administrator password needs to be entered.

6. Enter new administrator password.

»» Important

- When changing the password, the character is limited as follows.
 - Set the password using 4 to 32 characters.
 - Only alphanumeric characters are available.
 - From a security point of view, it is recommended to set the password of 8 characters or more in combination of alphanumeric characters.

7. Select **Apply**.

8. Enter the administrator password again.

9. Select **Apply**.

The administrator password is available.

When You Want to Disable the Administrator Password:



After selecting  (**Setup**) on the HOME screen, select **Printer settings > Administrator password settings > Remove administrator password**. Select either item and follow the on-screen instructions to perform settings.

Checking the Total Number of Uses of Printer

You can get information on printer usage, such as the number of sheets printed.

1. Select  (**Information**) on the HOME screen.

➔ [Home Screen Menu Composition](#)

2. Select  **Usage stats**.

3. Select item to check.

Total sheets used on the device

Displays the total number of sheets printed.

No. of sheets used for copying (TC-20M only)

Displays the total number of sheets copied.

Sheets used for other functions (TC-20M only)

Displays the total number of sheets printed with functions other than copying.

Number of sheets scanned (TC-20M only)

Displays the total number of sheets scanned.

»» Note

- The total area of roll paper used is printed on the nozzle check pattern. To print the nozzle check

pattern, select  (**Setup**) > **Maintenance** > **Nozzle Check**.

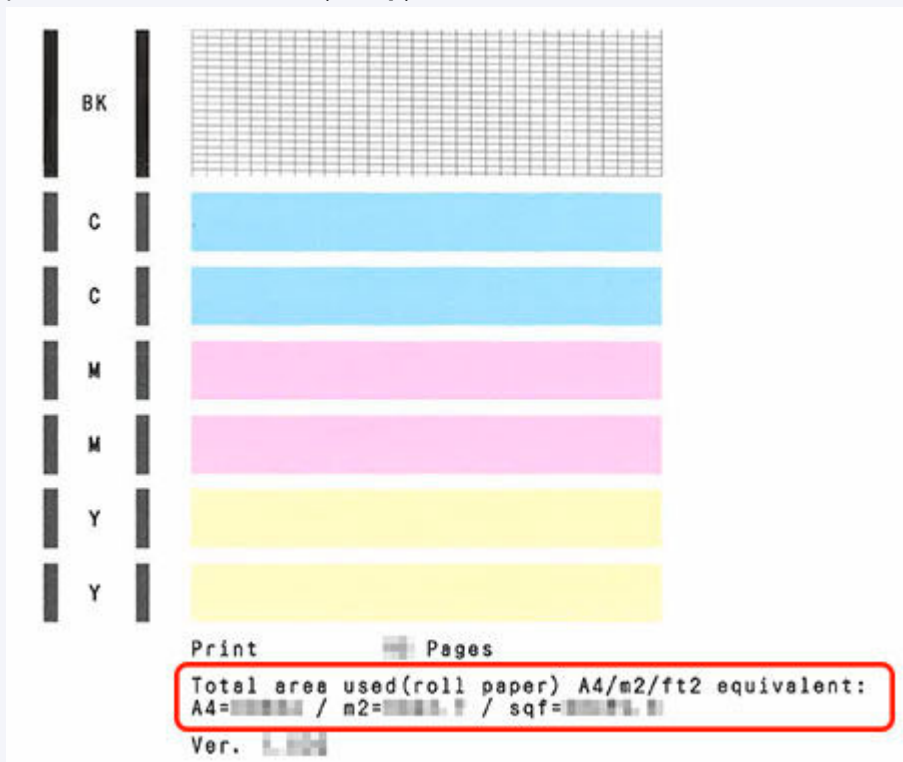

The total area of roll paper used is shown as the equivalent number of A4 sheets, as well as in square meters and square feet.

- Printer usage information is not reverted even if the printer is reverted back to the default by **Reset settings** in **Printer settings**.

Changing Printer's Setting Using Web Browser

- ▶ **Start up Remote UI**
- ▶ **Changeable Setting Items Using Remote UI**
- ▶ **Setting Passwords Using Remote UI**
- ▶ **Registering Printer's Root Certificate to Web Browser for SSL Communication**
- ▶ **Registering Printer's Root Certificate to Local Computer for SSL Communication**
- ▶ **Generating Server Certificate**
- ▶ **Setting Mail Server**
- ▶ **Specifying Mail Setting for Sending Scanned Data**
- ▶ **Receiving Printer Status by E-mail**

Start up Remote UI

You can check the printer status and change the printer settings using the web browser on your smartphone, tablet, or computer.

To check the printer status and to change the printer settings, display "Remote UI" on the web browser.

▶▶▶ Note

- Remote UI is a software that enables you to perform operations, which are usually performed on the printer's operation panel, using a Web browser over a network.

LAN connection with the printer is required to use Remote UI.

- You can use Remote UI on the following OS and the web browser.

- iOS device

Web browser: iOS standard Web browser (Mobile Safari)

- iPadOS device

Web browser: iPadOS standard Web browser (Mobile Safari)

- Android device

Web browser: Android standard Web browser (Browser or Chrome)

- macOS device

OS: macOS Mojave 10.14.6 or later

Web browser: macOS standard Web browser (Safari)

- Windows device

OS: Windows 7 SP1 or later

Web browser: Microsoft Edge, Mozilla Firefox, Google Chrome

- Enable JavaScript and cookies in the web browser.

1. Check printer's IP address.

1. Select  (**Network**) on the HOME screen.

➡ [Home Screen Menu Composition](#)

2. Select the enabled LAN.

Diagonal lines are displayed for disabled LAN icons.

3. Check **IPv4 address**.

2. Open web browser on your smartphone, tablet, or computer and enter IP address.

Enter as following in the URL field of the web browser.

http://XXX.XX.X.XXX

Enter the IP address of the printer in "XXX.XX.X.XXX".

►►► Note

- If you have set a DNS host name, you can also enter this.

When you access, "Remote UI" will be displayed on the web browser on your smartphone, tablet, or computer.

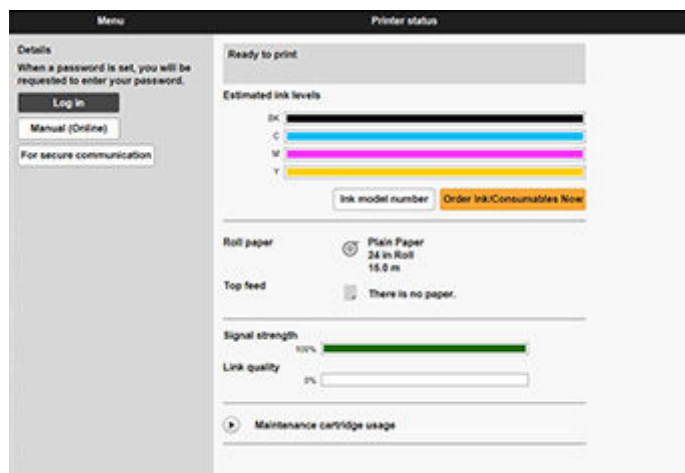

►►► Note

- If you display Remote UI for the first time on your smartphone, tablet, or computer, download the root certificate, and then register it.
 - ➔ [Registering Printer's Root Certificate to Web Browser for SSL Communication](#)
- If the root certificate is not registered, a message to warn you that the secure connection is not guaranteed may appear.

3. Select **Log in**.

The password authentication screen appears.

►►► Note

- When the standard user mode is enabled, choose either administrator mode or standard user mode to log on.
After choosing a mode and selecting **Log in**, the password authentication screen of each mode appears.

4. Enter password.

When the password authentication is complete, the menus that can be utilized are displayed on the web browser.

►►► Important

- The password is set at the time of purchase. The password is the printer serial number. The printer serial number is printed on the sticker attached on the printer. It consists of 9 alphanumeric characters.

For details on setting password, see [Setting Passwords Using Remote UI](#).

5. Confirm that the main screen of Remote UI is displayed.

For changeable setting items, see below.

➔ [Changeable Setting Items Using Remote UI](#)

When you finish checking printer status and changing printer settings, select **Log out**.

Changeable Setting Items Using Remote UI

►►► Note

- The item which can be used is different in administrator mode or in standard user mode.

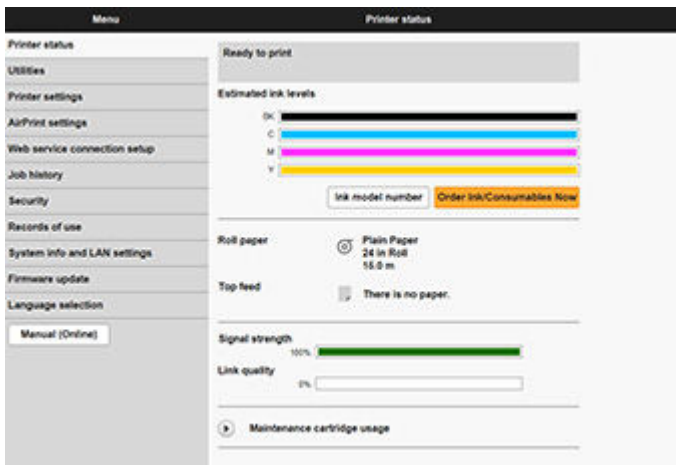

Printer status

This function displays printer information such as the remaining ink amount, the status, and detailed error information.

You can also connect to the ink purchase site or support page, and use Web Services.

Utilities

This function allows you to set and perform maintenance such as cleaning.

Printer settings

You can change various settings, such as print settings.

Additionally, this function allows you to receive the printer status information.

- ➔ [Setting Mail Server](#)
- ➔ [Receiving Printer Status by E-mail](#)

►►► Note

- Some of the menu is available only when you logged on in administrator mode.

AirPrint settings

This function allows you to specify the AirPrint settings when printing with AirPrint.

Web service connection setup

This function configures web services that use printer device information, such as PIXUS/MAXIFY Cloud Link.

Job history

This function allows you to display the job history and print it.

[Security](#)

You can specify passwords and settings related to certificates for encrypted communication (SSL/TLS settings).

Records of use

You can get information on printer usage, such as the number of sheets printed.

System info and LAN settings

- **Confirm system information**
- [LAN settings](#)

Firmware update

You can update the firmware of the printer, check the firmware version, or perform settings of a DNS server and a proxy server.

➡ [Firmware update](#)

Language selection

This function allows you to change the language on the display.

Manual (Online)

This function displays the *Online Manual*.

Security

- **Administrator password setting**

- ➔ [Setting Passwords Using Remote UI](#)

- **Standard user mode settings**

- Select Enable/Disable for the standard user mode.

- **SSL/TLS settings**

- Perform settings of a certificate for encrypted communication.

- Available TLS settings** enables you to specify the range of the version used for SSL/TLS communication.

- **IEEE802.1X/EAP settings**

- **Authentication**

- Select the authentication method.

- ▶▶▶ **Note**

- In the case of using IEEE802.1X certificate, **Security > IEEE802.1X/EAP settings > CA certificate**, and register the CA certificate.

- Supported authentication method

- EAP-TLS(Extensible Authentication Protocol-Transport Level Security)

- EAP-TTLS(EAP-Tunneled TLS)

- PEAP(Protected EAP)

- **Key and certificate settings**

- Perform settings for key and client certificate.

- **CA certificate**

- Perform settings for the CA certificate that verifies a server certificate.

- **Enable/disable IEEE802.1X/EAP**

- Select to enable or disable IEEE802.1X/EAP.

LAN settings

- **Wi-Fi**

Enables/Disables Wi-Fi.

- **Wireless Direct**

Enables/Disables Wireless Direct.

- **Wired LAN**

Enables/Disables Wired LAN.

- **Confirm LAN settings**

The LAN setting information is displayed.

- **Advanced setup**

- **Set printer name**

Specifies the printer name. You can use 2 to 15 characters for the name.

▶▶▶ Note

- You cannot use the same printer name as that already used for other LAN connected devices.
- You cannot use a hyphen for the initial or last character of the printer name.

- **TCP/IP settings**

Performs IPv4 or IPv6 setting.

- **WSD settings**

Perform settings to use WSD.

- **Bonjour settings**

Perform settings to use Bonjour.

- **LPD print**

Perform settings for printing with LPD.

- **SNMP settings**

Perform settings for using SNMP to manage and control the printer.

- **IPP Settings**

Perform settings for printing with IPP.

- **CHMP settings**

Perform settings for communication at the time when printer drivers or applications acquire the information on status, paper, and job log, from the printer.

Enable HTTPS redirection redirects the communication using CHMP to encrypted communication.

▶▶▶ Note

- To use CHMP for encrypted communication, you need to register the printer's root certificate to your computer.

➡ [Registering Printer's Root Certificate to Local Computer for SSL Communication](#)

- CHMP is a Canon proprietary protocol.

- **DRX settings**

Selecting **Enable** perform the intermittent data reception when connecting to the network.

- **IPsec settings**

When Enable is selected, IPsec security can be configured.

- **IP filtering**

Allows or denies access for specific IP addresses.

Settings for both IPv4 and IPv6 addresses can be specified.

▶▶▶ Important

- If you accidentally set the address of the administrator's device to be rejected, select



(**Setup**) on the HOME screen of the operation panel, then select **Printer settings > Reset settings > LAN settings only** to reset the printer's network settings.

After resetting, perform setup again as necessary.

- **MTU**

Configures the MTU settings.

Setting Passwords Using Remote UI

Each of passwords for administrator and standard user can be set.

When logging on with password for administrator, all settings can be changed.

When logging on with password for standard user, some of the settings can be changed.

➔ [Setting Administrator Password](#)

➔ [Setting Standard User Password](#)

▶▶▶ Note

- Password can be set only when you are logged in administrator mode.
- The standard user password is disabled by default.

Setting Administrator Password

Change the administrator password by following the steps below.

▶▶▶ Important

- The password is set at the time of purchase. The password is the printer serial number. The printer serial number is printed on the sticker attached on the printer. It consists of 9 alphanumeric characters.

1. Start up **Remote UI**.

➔ [Start up Remote UI](#)

2. Select **Security**.

3. Select **Administrator password setting**.

4. Select **Change administrator password**.

If an administrator password is not specified, the confirmation message appears. Confirm the message and select **Yes**. When message appears again, confirm it and select **OK**.

5. Select range where administrator password is valid and select **OK**.

Remote UI and other tools

Entering the administrator password is required to change the setting items using the Remote UI or some software.

Operation panel/Remote UI/other tools

Entering the administrator password is required to change the setting items using the operation panel of the printer, the Remote UI, or some software.

6. Enter password and select **OK**.

▶▶▶ Important

- The following character restrictions apply to the password:

- Set the password by using 4 to 32 characters.
- The allowed characters are single-byte alphanumeric characters, blank space, umlaut characters, and the below characters.
- ! @ # \$ % ^ & * _ ; : , . / ` = + ' " () { } [] < > |
- For security reasons, we recommend you use 8 and more alphanumeric characters.

7. When completion message appears, select **OK**.

Setting Standard User Password

For restricting the function for standard user, enable the standard user mode and set a standard user password by following the steps below.

1. Start up **Remote UI**.

➔ [Start up Remote UI](#)

2. Select **Security**.

The menus appear.

3. Select **Standard user mode settings**.

4. When confirmation message appears, select **Yes**.

5. Enter password and select **OK**.

Important

- The following character restrictions apply to the password:
 - Set the password by using 4 to 32 characters.
 - The allowed characters are single-byte alphanumeric characters, blank space, umlaut characters, and the below characters.
- ! @ # \$ % ^ & * _ ; : , . / ` = + ' " () { } [] < > |
 - For security reasons, we recommend you use 8 and more alphanumeric characters.

6. When completion message appears, select **OK**.

Registering Printer's Root Certificate to Web Browser for SSL Communication

If the printer's root certificate has not been registered to the web browser, a message to warn you that the secure connection is not guaranteed may appear.

When you display Remote UI for the first time on your smartphone, tablet, or computer, download the root certificate, and then register it to the web browser. The secure connection will be confirmed and a message will not appear. However, the message may appear depending on a web browser even after you have registered the root certificate.

How to register the root certificate varies depending on the web browser.

- ➔ [For Microsoft Edge](#)
- ➔ [For Safari](#)
- ➔ [For Chrome on Android](#)
- ➔ [For Mobile Safari on iOS](#)

Operating procedure may differ depending on the version of your web browser. For other web browser, refer to each help.

▶▶▶ Important

- Make sure that you have accessed to the printer IP address correctly by checking the URL field of the web browser before registering the root certificate.
- If the printer is connected via IPv6 using Windows, you need to generate a server certificate using Remote UI.

For details, see [Generating Server Certificate](#).

For Microsoft Edge

1. Select **For secure communication** on Remote UI.

2. Select **Download**.

Downloading the root certificate is started.

3. If confirmation screen appears, select **Open**.

Certificate screen is displayed.

▶▶▶ Note

- To save the certificate file and register it, select **Save**. To register, select **Control Panel > Network and Internet > Internet Options**, and register the root certificate from **Certificates on Content** sheet.

4. Select **Install Certificate**.

Certificate Import Wizard screen is displayed.

5. Select **Next**.
6. Select **Place all certificates in the following store**.
7. Select **Browse**.
Select **Certificate Store** screen is displayed.
8. Select **Trusted Root Certification Authorities** and **OK**.
9. Select **Next** on **Certificate Import Wizard** screen.
10. If **Completing the Certificate Import Wizard** appears, select **Finish**.
Security Warning screen is displayed.
11. Make sure that thumbprint on **Security Warning** screen matches printer's thumbprint.
To display the printer's root certificate thumbprint in **Root cert. thumbprint (SHA-1)** or **Root cert. thumbprint (SHA-256)**, select  (**Information**) on the HOME screen of the operation panel, and then select **System information**.
12. If thumbprint on **Security Warning** screen matches printer's thumbprint, select **Yes**.
13. Select **OK** on **Certificate Import Wizard** screen.
The root certificate registration is completed.

For Safari

1. Select **For secure communication** on Remote UI.
2. Select **Download**.
Downloading the root certificate is started.
3. Open the downloaded file.
Keychain access starts up and **Add Certificates** screen is displayed.
4. Select **Add**.
Information on the certificate is displayed.

▶▶▶ Note

- You can also add the certificate by selecting **Show Certificate**, checking certificate name to add, and then selecting the same certificate on Keychain access.

5. Make sure that fingerprint of certificate detail information matches printer's thumbprint.

To display the printer's root certificate thumbprint in **Root cert. thumbprint (SHA-1)** or **Root cert.**

thumbprint (SHA-256), select  (**Information**) on the HOME screen of the operation panel, and then select **System information**.

6. If fingerprint of certificate detail information matches printer's thumbprint, display information on certificate from the menu or by double-clicking the certificate, and select **Always Trust** on **Trust**.

The root certificate registration is completed.

▶▶▶ Note

- If a password is set on your device, entering a password may be required.

For Chrome on Android

1. Select **For secure communication** on Remote UI.

2. Select **Download**.

Downloading the root certificate is started and then **Name the certificate** screen is displayed.

3. As entering the root certificate name is required, enter an arbitrary certificate name and select **OK**.

The root certificate registration is completed.

▶▶▶ Note

- If PIN or password is not set as security type, the attention screen may appear. Select **OK**, and then set the security type to PIN or password.

After Root Certificate Registration

We recommend that you make sure that the correct root certificate has been registered.

To make sure that the correct root certificate has been registered, make sure that thumbprint of certificate information matches printer's thumbprint. Follow the steps below.

▶▶▶ Note

- Some Android devices cannot be checked the thumbprint of a registered route certificate.

1. From **Settings** menu on your device, select **Security, Trust credentials**, and **USER**.

The list of downloaded certificates appears.

2. Select downloaded certificate.

The certificate information appears.

3. Make sure that thumbprint of certificate information matches printer's thumbprint.

To display the printer's root certificate thumbprint in **Root cert. thumbprint (SHA-1)** or **Root cert.**

thumbprint (SHA-256), select  (**Information**) on the HOME screen of the operation panel, and then select **System information**.

4. If thumbprint of certificate information screen matches printer's thumbprint, select **OK**.

The root certificate registration is completed.

If the message to warn you that the secure connection is not guaranteed appears when you select **Log in** on Remote UI after registering the root certificate, restart the web browser. The message will not appear on the web browser.

▶▶▶ Note

- Depending on the Android device, a warning may appear even after registering the proper root certificate.

For Mobile Safari on iOS

1. Select **For secure communication** on Remote UI.

2. Select **Download**.

Downloading the root certificate is started and then **Install Profile** screen is displayed.

3. Select **Install**.

Warning screen is displayed.

▶▶▶ Note

- If a password is set on your device, entering a password may be required.

4. Select **Install**.

5. Select **Install** on displayed dialog.

The root certificate registration is completed.

Registering Printer's Root Certificate to Local Computer for SSL Communication

To use Device Management Console or Accounting Manager, etc. when you connect the printer to a computer using SSL encrypted communication, you need to register (import) the printer's root certificate to your computer.

Procedure to register the certificate varies depending on your operation environment.

▶▶▶ Important

- If the printer is connected via IPv6 using Windows, you need to generate a server certificate using Remote UI.

For details, see [Generating Server Certificate](#).

➡ [For Windows 11/Windows 10/Windows 8.1](#)

➡ [For Windows 7](#)

➡ [For macOS](#)

Operation procedure may differ depending on your OS version.

For Windows 11/Windows 10/Windows 8.1

The procedure below describes how to import a root certificate in Windows 11/Windows 10/Windows 8.1.

1. Start up Remote UI.

➡ [Start up Remote UI](#)

2. Select **For secure communication**.

▶▶▶ Note

- You can download a certificate from Status Monitor.

1. Open status monitor.

Open the **Printing preferences**, and select **Status Monitor...** on **Main**.

2. Download a certificate.

Select **Download Security Certificate** from the **Remote UI** menu.

3. Select **Download**.

The root certificate will be downloaded.

4. When download confirmation screen is displayed, select **Open**.

The **Certificate** screen appears.

5. Select **Install Certificate**.

The **Certificate Import Wizard** screen appears.

6. Select **Local Machine**.

1. Select **Local Machine** on the startup screen of **Certificate Import Wizard**.

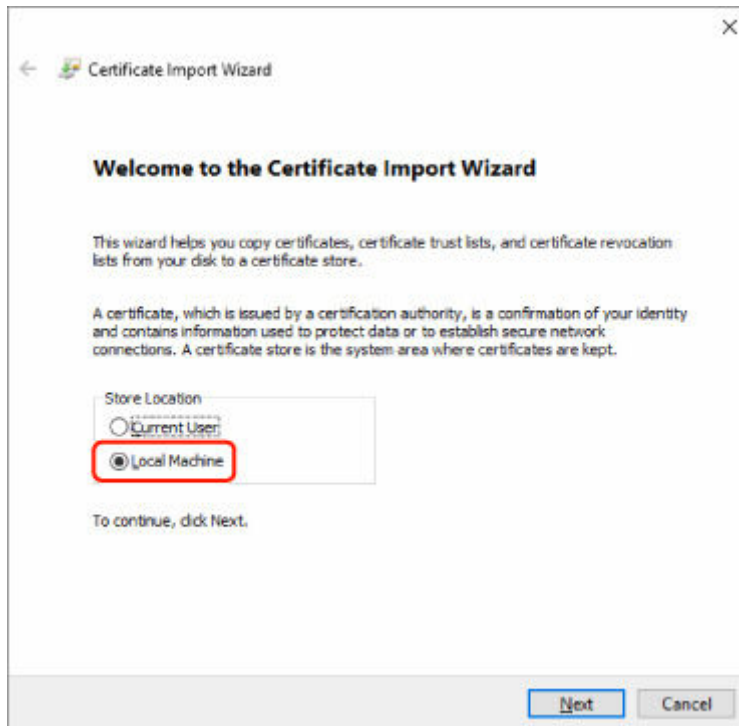

2. Select **Next**.
3. Select **Yes** on the displayed screen.

The **Certificate Store** screen appears.

7. Select **Place all certificates in the following store**.

8. Select **Trusted Root Certificate Authorities**.

1. Select **Browse** to open the **Select Certificate Store** screen.
2. Select **Trusted Root Certificate Authorities** from the list and select **OK**.
3. Select **Next** on the **Certificate Store** screen.

9. Select **Finish**.

When the **Completing the Certificate Import Wizard** screen appears, check the settings and select **Finish**.

For Windows 7

The procedure below describes how to import a root certificate in Windows 7.

»» Important

- Be sure to create a certificate snap-in before importing a root certificate.

The root certificate will be registered to the local user if you import it without creating a certificate snap-in.

Creating Certificate Snap-in

1. Start up Microsoft Management Console.

Enter **MMC** on **Search programs and files** in the **Start** menu and press the Enter key.

2. Select **Yes** on displayed screen.

3. Select **Add/Remove Snap-in** from **File** menu.

The **Add or Remove Snap-ins** screen appears.

4. Add **Certificate** snap-in.

1. Select **Certificates** from **Available snap-ins** list and select **Add**.

2. Select **Computer account** for **This snap-in will always manage certificates for** on the **Certificates snap-in** screen and select **Next**.

3. Select **Local computer** on the **Select computer** screen and select **Finish**.

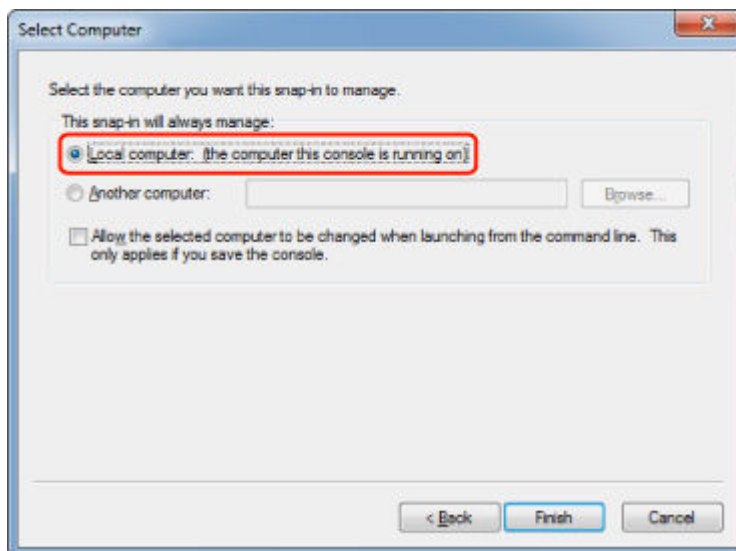

4. Select **OK** on the **Add or Remove Snap-ins** screen.

Downloading Certificate

1. Start up Remote UI.

➔ [Start up Remote UI](#)

2. Select **For secure communication**.

▶▶▶ **Note**

- You can download a certificate from Status Monitor.

1. Open status monitor.

Open the **Printing preferences**, and select **Status Monitor...** on **Main**.

2. Download a certificate.

Select **Download Security Certificate** from the **Remote UI** menu.

3. Select **Download**.

4. Select **Save**.

Importing Certificate

1. Open **Certificate Import Wizard**.

1. On the left window, open **Trusted Root Certificate** from **Certificate** on **Console Root**.

2. Right-click **Certificates** and select **Import** from **All tasks**.

2. Specify certificate file to import.

1. Select **Next**.

2. Specify the certificate file to import on **File name** and select **Next**.

3. Specify certificate store.

1. Select **Place all certificates in the following store**.

2. Select **Trusted Root Certificate Authorities** for **Certificates Store**.

4. Finish certificate import wizard.

1. Select **Next** and check the specified settings.

2. Select **Finish** to finish the wizard.

3. Select **OK** on the displayed screen.

Checking Imported Certificate

Make sure the imported certificate has been registered to your computer.

1. Display certificate list.

On the left window of Microsoft Management Console, select **Console Root > Certificates (Local Computer) > Trusted Root Certificate Authorities** in this order, and Select **Certificates** to display the certificate list.

2. Check registered certificate.

Make sure the imported certificate name is displayed on the list.

»» Note

- Make sure you can see the registered certificate from **Current user** by creating the **Current user** snap-in.

»» Note

- When you finish Microsoft Management Console, a message asking you whether to save the console setting. If you continue to apply the same settings next, select **Yes** to save.

For macOS

The procedure below describes how to import a root certificate in macOS.

1. Start up Remote UI.

➔ [Start up Remote UI](#)

2. Select **For secure communication**.

3. Select **Download**.

The root certificate will be downloaded.

4. Open downloaded certificate file.

When the download procedure is completed, a downloaded item pops up on the right of the screen.

Double-click the downloaded certificate on the list starts up **Keychain Access** and the **Add Certificates** screen appears.

»» Note

- If the downloaded item does not pop up, select the **Show Downloads**  button on the right.
- Selecting the magnifying glass icon on the right of download list displays the folder containing the certificate.

5. Select **Add**.

Select the destination for the certificate on **Keychain**.

Selecting **Add** displays information on the certificate.

»» Note

- You can add the certificate by selecting the same certificate on **Keychain Access**. Check the name of certification to add after selecting **View Certificates**.

6. Check certificate.

Make sure the fingerprint of certificate shown on **Details** corresponds with the root certificate thumbprint of the printer.

To display the printer's root certificate thumbprint in **Root cert. thumbprint (SHA-1)** or **Root cert.**

thumbprint (SHA-256), select



(Information) on the HOME screen of the operation panel, and then select **System information**.

7. Select **Always Trust**.

If the fingerprint of certificate detail information matches printer's thumbprint, display information on certificate from the menu or by double-clicking the certificate, and select **Always Trust** on **Trust**.

The root certificate has been registered.

»» Note

- Entering the password may be required if you specify it for your printer.

Generating Server Certificate

When you use SSL connection via IPv6 network, you need to generate an IPv6 server certificate using the printer.

Generate the server certificate from Remote UI.

Follow the procedure below.

1. [Checking Printer's IP Address](#)
2. [Generating Server Certificate](#)
3. [Checking Generated Server Certificate](#)

»» Important

- If you generate an IPv6 server certificate, a warning message may appear if you are using Remote UI.
To reset the IPv6 server certificate, select **Security > SSL/TLS settings > Delete key and certificate** in this order, and select **OK** on the displayed screen.

Checking Printer's IP Address

1. Select  **Network** on the HOME screen.

➡ [Home Screen Menu Composition](#)

2. Select the enabled LAN.

Diagonal lines are displayed for disabled LAN icons.

3. Select **See settings**.

4. Check the value on **IPv6 link-local address**.

Write down the value on **IPv6 link-local address** for your reference when you generate a server certificate.

Generating Server Certificate

1. Start up Remote UI.

➡ [Start up Remote UI](#)

2. Select **Security**.

3. Select **SSL/TLS settings**.

4. Select **Generate key and certificate**.

5. Select **Generate self-signed cert.**

6. Specify each setting item.

- **Signature algorithm**

Select **SHA256**.

- **Public key length (bits)**

Select **2048 bits**.

- Specify the expiration date.

Enter the date you generated the server certificate on **Valid from**.

Enter the date the server certificate expires on **Valid to**.

- Enter the common name.

On **Common name**, enter the **IPv6 link-local address** you checked in abbreviated form.

▶▶▶ Note

- When you enter the common name, add [] to each end of the abbreviation value of the printer's IPv6 address.
- Do not use a comma or make a space for the common name.

7. Select **Next.**

You need not enter anything on **Country, State or province, Locality, Organization, or Organizational unit**.

8. Select **Generate.**

The server certificate starts to be generated.

When the server certificate has been generated, **Generated a self-signed certificate** appears.

9. Select **Restart LAN.**

LAN will be restarted.

When LAN has been restarted, **Printer status** on Remote UI appears.

▶▶▶ Note

- If you cannot access to Remote UI after you restart LAN, reload your web browser.

Checking Generated Server Certificate

1. Select **Security on Remote UI.**

2. Select **SSL/TLS settings.**

3. Select **Check key and certificate.**

Make sure the issuer of the root certificate is displayed on **Issued by**, and the value you entered is displayed on **Common name** on **Subject**.

Setting Mail Server

To use mail function, specify the mail server settings.

▶▶▶ Note

- If you did not specify the time zone setting using the printer's operation panel, a message to inform you that the correct time may not be reflected on the sent e-mail appears. We recommend that you set the time zone setting using the printer's operation panel.

➡ [Other printer settings](#)

- These functions can be set only when you are logged in administrator mode.

1. Launch the remote UI.

➡ [Start up Remote UI](#)

2. Select **Printer settings**.

3. Select **Set mail server / test connect**.

4. Select **Set mail server**.

5. Specify mail server settings.

Specify the following items.

- **Sender address**
Enter the e-mail address of the sender (this printer).
- **Outgoing mail server (SMTP)**
Enter the address of your SMTP server.
- **Port number (SMTP)**
Enter the port number of your SMTP server.
- **Secure connection (SSL)**
Select if you use the secure connection (SSL).
- **Don't verify certificates**
Select if you do not verify the certificate.
- **Authentication**
Select one of the following authentication methods.
- **SMTP authentication**
Select if you send e-mail with SMTP authentication.

Next, you can specify the following settings.

- **Outgoing account**
Enter the account name for sending to perform the authentication.

- **Outgoing password**

Enter the password for sending to perform the authentication.

- **POP before SMTP**

Select if you send e-mail with POP before SMTP authentication.

Next, you can specify the following settings.

- **Incoming mail server (POP3)**

Enter the address of your POP server.

- **Port number (POP3)**

Enter the port number of your POP server.

- **Incoming account**

Enter the account name for receiving to perform the authentication.

- **Incoming password**

Enter the password for receiving to perform the authentication.

- **Use APOP authentication**

Select if you send the password by the encryption transmission.

- **Clear mailbox**

Select if you delete the e-mails that remain in the POP3 server.

▶▶▶ Important

- When this setting is enabled, e-mail in the Inbox on the server will have all been removed. If you specify the e-mail address of your everyday, be sure to disable this setting as unread e-mail is not deleted. We recommend that you prepare this printer dedicated e-mail account not to accidentally delete the unread e-mail.

- **No authentication**

Select if the authentication is not necessary.

6. After specifying mail server settings, select **OK.**

The setting operation is completed.

▶▶▶ Note

- To make sure that the mail server settings have been specified correctly, select **Test connection to mail server**.

Specifying Mail Setting for Sending Scanned Data

This function is available only for TC-20M.

You can specify the mail settings to send the scanned data from printer via e-mail.

This section describes the mail settings such as the title of e-mail, initial body text, and file size.

▶▶▶ Note

- These functions can be set only when you are logged in administrator mode.
- To send the scanned data from printer via e-mail and to register the e-mail address of the destination, see below.
 - ➔ [Sending Scanned Data as E-Mail from Printer](#)
- Specify the mail server settings in advance.
 - ➔ [Setting Mail Server](#)

1. Launch the remote UI.

- ➔ [Start up Remote UI](#)

2. Select **Printer settings**.

3. Select **Scan(Email direct from device)**.

4. Select **E-mail transmission settings**.

5. Specify mail settings.

Specify the following items.

- **Subject**

Enter the title of the e-mail up to 20 alphanumeric characters.

▶▶▶ Note

- The title that you specify here is the initial title when sending scan data. You can change the title when sending scan data using the printer's operation panel.

- **Body text**

Enter the body text of the e-mail up to 80 alphanumeric characters.

- **Maximum attachment size**

Select a maximum file size of the scan data that can be sent.

6. After specifying mail settings, select **OK**.

The setting operation is completed.

Receiving Printer Status by E-mail

You receive the printer status information such as the remaining ink level and the error from the printer.

* This function may not be available depending on the country or region of purchase.

▶▶▶ Note

- Specify the mail server settings in advance.
 - ➔ [Setting Mail Server](#)
- If you did not specify the date and time setting using the printer's operation panel, the date and time may not be reflected on the sent e-mail. We recommend that you set the date and time setting using the printer's operation panel.

For the date and time setting, see [Other printer settings](#).
- These functions can be set only when you are logged in administrator mode.

1. Start up Remote UI.

- ➔ [Start up Remote UI](#)

2. Select **Printer settings**.

3. Select **Status notification email**.

4. Select **Notification recipients**.

5. Specify destination settings.

Up to 5 destinations can be registered by following the steps below.

1. Select number of destination.
2. Select **Add**.
3. Enter e-mail address, and then select printer status to send information.
4. Select **OK**.

The registration for destination is completed.

6. Select **Printer settings > Status notification email > Retry settings**.

7. Specify resending settings.

The number of resending can be specified by following the steps below.

1. Specify number of resending.
2. Specify interval of resending.

3. Select OK.

The resending setting is completed.

Network Setting

- ▶ **Printer Connection Methods**
 - Wi-Fi Connection
 - Wireless Direct Connection
 - Wired Connection
 - USB Connection
- ▶ **Default Network Settings**
- ▶ **Another Printer Found with Same Name**
- ▶ **Printing Network Settings**
- ▶ **Countermeasures against Unauthorized Access**
- ▶ **Network Status and Troubleshooting**
- ▶ **Checking Printer Connection Status Using Wi-Fi Connection Assistant**
- ▶ **Sharing the Printer on a Network (Windows)**
 - Setting Up a Shared Printer
 - Restrictions on Printer Sharing
- ▶ **Sharing the Printer on a Network (macOS)**
 - Settings on Print Server
 - Settings on Client PC
 - Restrictions on Printer Sharing

Printer Connection Methods

4 connection methods are available on the printer.

- [Wi-Fi Connection](#)



- [Wireless Direct Connection](#)



- [Wired Connection](#)

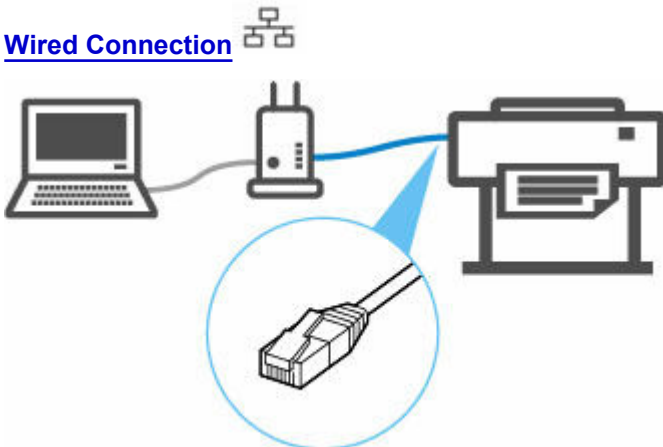

- [USB Connection](#)



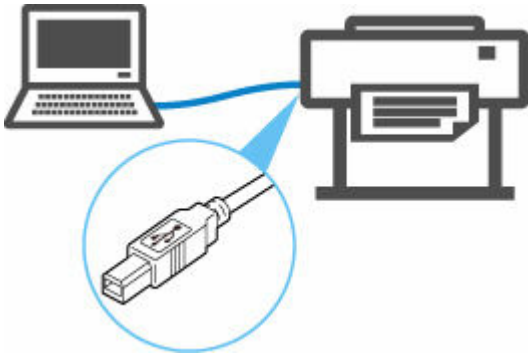

The printer cannot use a wired LAN connection simultaneously with a Wi-Fi or wireless direct connection.

When connecting another device while the devices are already connected to the printer, connect using a method other than the above.

➡ Restrictions

➤➤➤ Important

- If you connect a device connected to the Internet via a wireless router to the printer that is in the wireless direct, the connection between the device and wireless router will be disabled. In that case, the connection of the device may switch to a mobile data connection automatically depending on your device. Transmission fees for connecting to the Internet using a mobile data connection apply.

Wi-Fi Connection

Follow the procedure below to setup a printer.

▶▶▶ Note

- Refer to the following notes when connecting to Wi-Fi.
 - ➔ Notes on Wi-Fi Connection

1. Make sure printer is turned on before starting wireless connection setup.

If the power is on, the **ON** lamp will be lit.

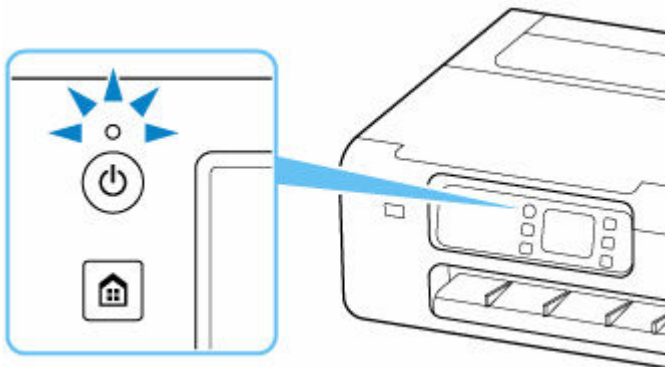

▶▶▶ Important

- If printer is performing cleaning, print head alignment, or other processes, wait for the process to finish, before starting setup.

2. Press the **HOME** button.

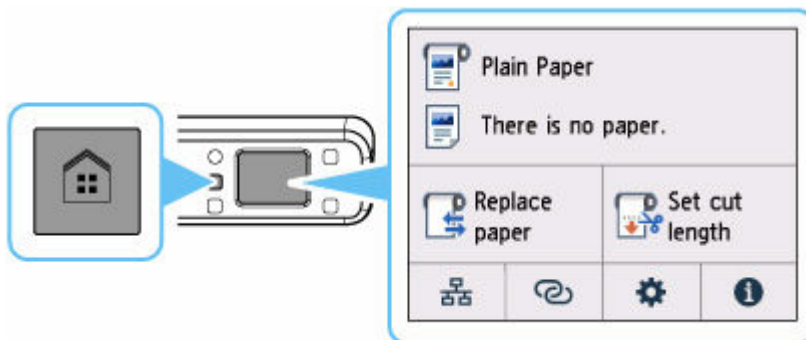

▶▶▶ Note

- If an error screen appears, select **OK**, and then press the **HOME** button.

3. On the HOME screen, select the **Network** icon.

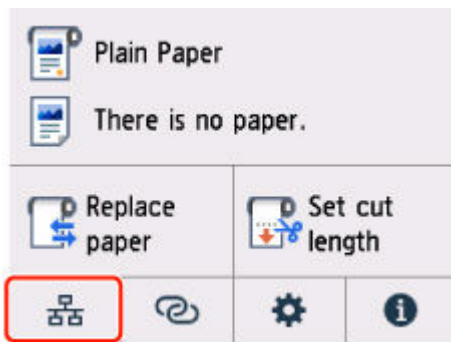

Depending on the current LAN status, the icon displayed on the button may differ.

➔ [Home Screen Menu Composition](#)

4. Select Wi-Fi.



5. Select Wi-Fi setup.

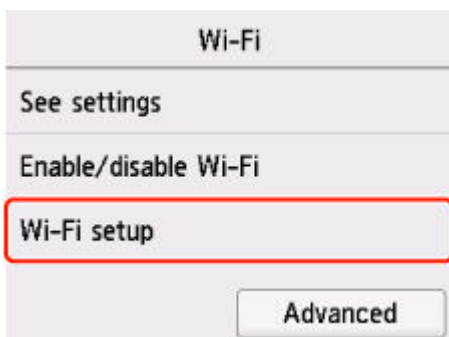

6. Select a connection method below.

Easy wireless connect

Set wireless router information to the printer directly from a device (such as a computer), without operating the wireless router

Easy wireless connect may take some time. Internet connection may become temporarily unavailable during setup.

Easy wireless connect is not available on Chrome OS or Windows 10 in S mode. Select **Other connection types**.

Manual connect

Connect to wireless router using a password

WPS

Connect to a WPS-compatible wireless router

WPS (PIN Code) Connection

A wireless connection can also be set up by using the WPS PIN code method

WPS Connection

1. Select **WPS (Push button method)**.

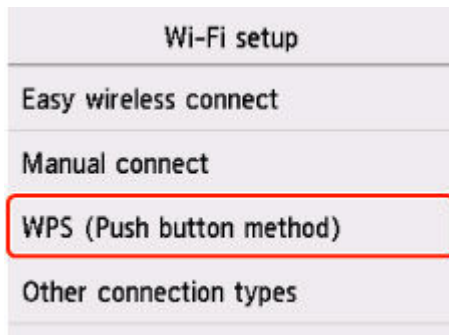

2. Select **OK**.

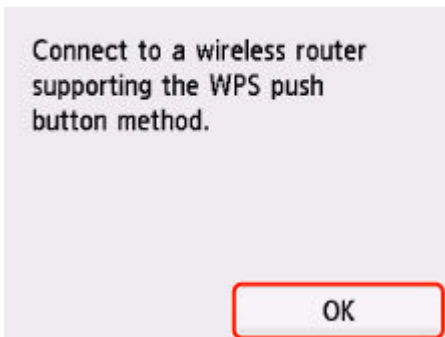

3. Press and hold the WPS button on the wireless router.

▶▶▶ Note

- For more on pressing the WPS button, see the wireless router manual.

4. Select **OK** on the printer within 2 minutes.

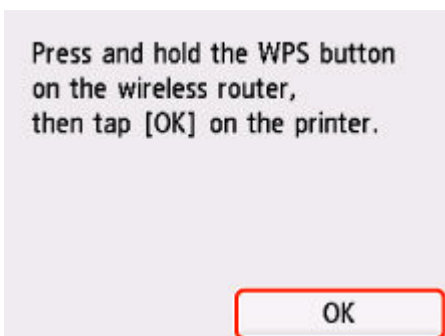

5. When the screen on the below appears, select **OK**.

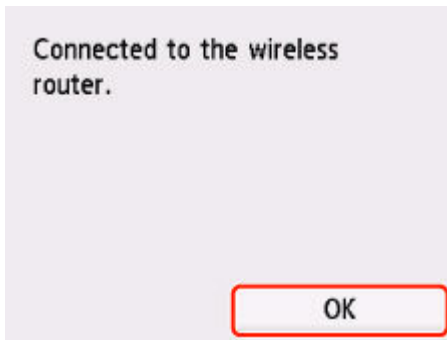

6. Press the **HOME** button.

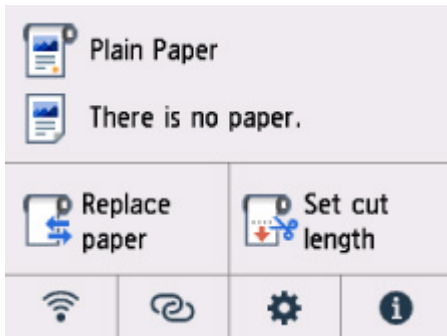



The network connection setup is now complete.



Once connection is complete,  appears on the screen.

If performing setup with software, return to the software and proceed with the installation.

Windows

Click  (or ) on the  taskbar at the bottom of the screen, follow the on-screen instructions to proceed with setup.

macOS

Click  on the  Dock at the bottom of the screen, and follow the on-screen instructions to proceed with setup.

WPS (PIN Code) Connection

1. Select **Other connection types**.

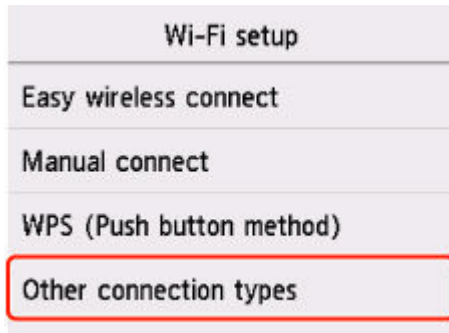

2. Select **WPS (PIN code method)**.

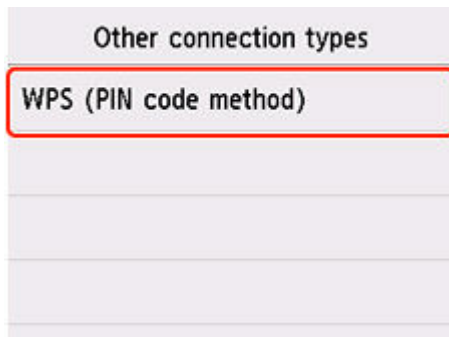

3. Follow the on-screen instructions on a computer to set a PIN code on the wireless router.

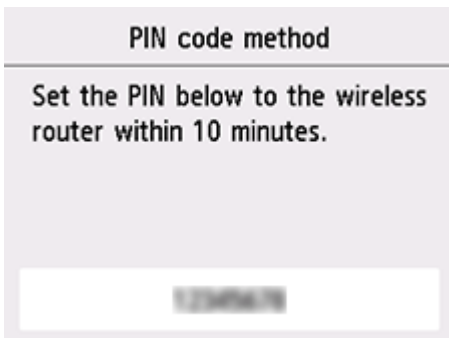

4. When the screen on the below appears, select **OK**.

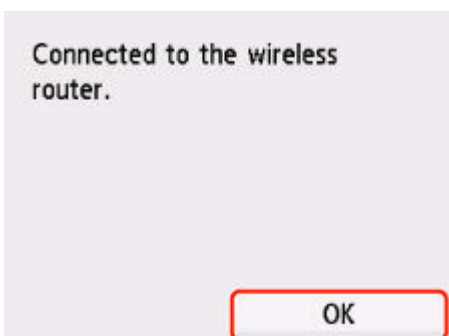

5. Press the **HOME** button.

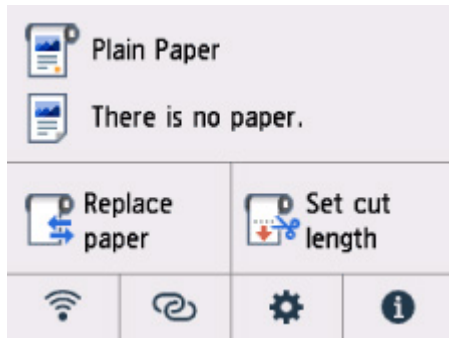



The network connection setup is now complete.



Once connection is complete,  appears on the screen.

If performing setup with software, return to the software and proceed with the installation.

Windows

Click  (or ) on the  taskbar at the bottom of the screen, follow the on-screen instructions to proceed with setup.

macOS

Click  on the  Dock at the bottom of the screen, and follow the on-screen instructions to proceed with setup.

Manual connect

1. Select **Manual connect**.

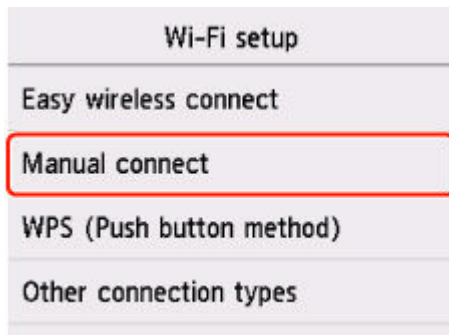

2. Select your wireless router.

If you select a Wi-Fi router name, proceed to step 8 and continue with the settings.

If you select [Directly enter the wireless router name], proceed to step 3 and continue with the settings.

If [Failed to connect to the wireless router.] appears, see ["Failed to connect to the wireless router." Appears](#)

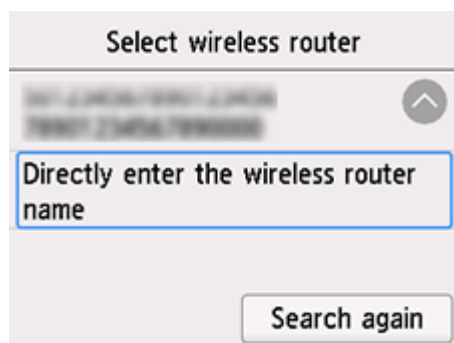

3. Select the input area.

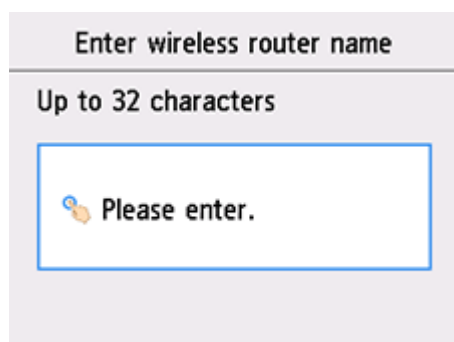

4. Enter the wireless router name (SSID). Text entry is case-sensitive.

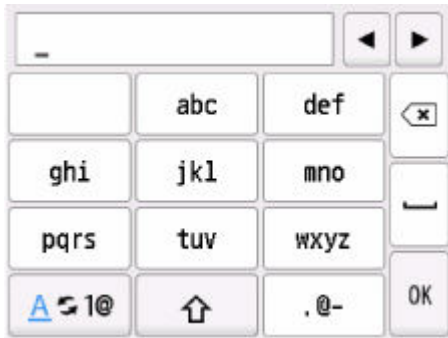

If you don't know your wireless router name, see the wireless router manual or contact its manufacturer.

5. Select **OK**.



6. Make sure the wireless router name (SSID) is correct.

7. Select **OK**.

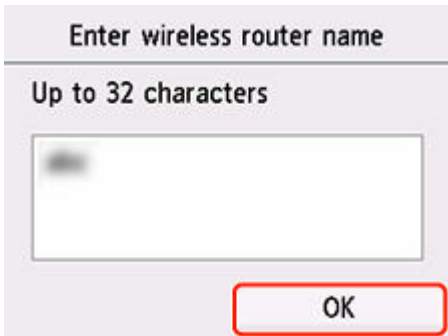

8. The screen below will appear.

If "**Connected to the wireless router.**" appears, the network does not require a password. Continue from step 13.

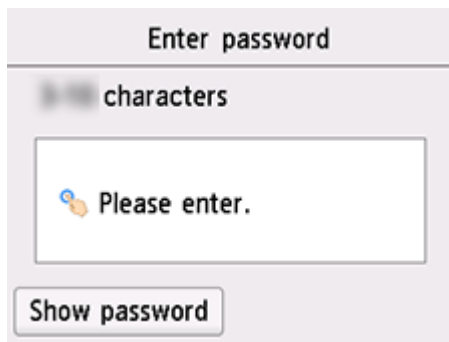

9. Select the input area.

10. Enter the password. Text entry is case-sensitive.



If you don't know the password for your wireless router, see the wireless router manual or contact its manufacturer.

11. Select **OK**.



12. Select **OK**.



13. When the screen on the below appears, select **OK**.

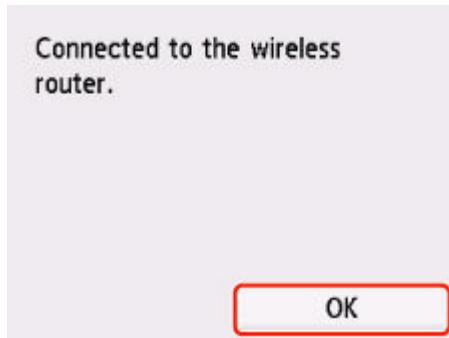

14. Press the **HOME** button.

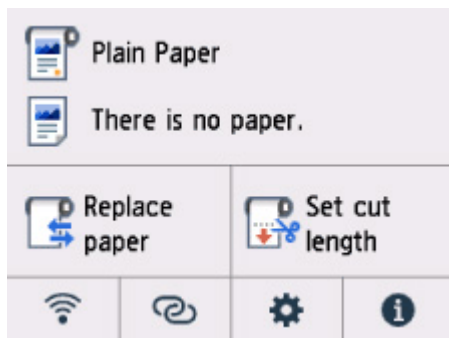



The network connection setup is now complete.



Once connection is complete,  appears on the screen.

If performing setup with software, return to the software and proceed with the installation.

Windows

Click  (or ) on the  taskbar at the bottom of the screen, follow the on-screen instructions to proceed with setup.

macOS

Click  on the  Dock at the bottom of the screen, and follow the on-screen instructions to proceed with setup.

Easy wireless connect

1. Select **Easy wireless connect**.

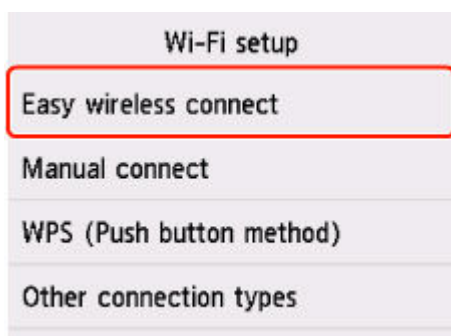

2. Select **Start**.



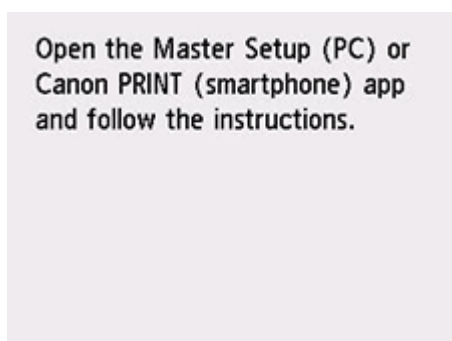

3. When the printer preparation is complete, the screen below appears.



4. Return to the application software and proceed with the setup.

Windows

Click  (or ) on the  taskbar at the bottom of the screen, follow the on-screen instructions to proceed with setup.

macOS



Click on the



Dock at the bottom of the screen, and follow the on-

screen instructions to proceed with setup.

Wireless Direct Connection

This section describes wireless direct, which allows you to print by connecting the devices to the printer directly.

Important

- Check the usage restrictions and switch the printer to the wireless direct.
 - ➔ Restrictions
- The administrator password is required to change settings if it is enabled for changing settings using the operation panel.
- If a device has already been connected to the printer directly and you want to add a device to connect, connect it to the printer directly. You can connect up to 5 devices to the printer at the same time.

Enable Wireless Direct

1. On the HOME screen, select the **Network** icon.

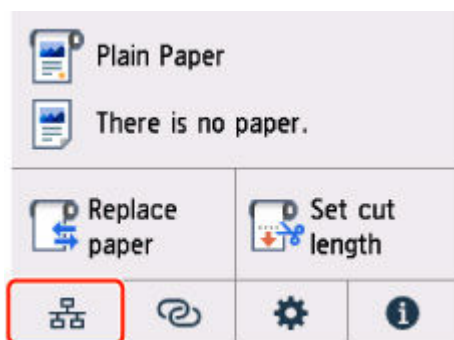

Depending on the current LAN status, the icon displayed on the button may differ.

➔ [Home Screen Menu Composition](#)

2. Select **Wireless Direct**.
3. Select **Enable/disable Wireless Direct** and select **Yes**.
4. Confirm displayed message and select **OK**.

After Wireless Direct is enabled, the identifier (SSID) etc. when using the printer with wireless direct connection are displayed.

By flicking the touch screen, you can check various settings of wireless direct.

Note

- The identifier (SSID) and password are specified automatically.
- You can check the password set for the printer by the following method.

1. On the HOME screen, select  (**Network**).

2. Select **Wireless Direct**.

3. Select **Change password**.
 4. Select **Change manually**.
 5. Select **Show password**.
- By selecting **Wireless Direct**, you can change the following settings.
 - **Enable/disable Wireless Direct**
 - **Change network name (SSID)**
 - **Change password**
 - **Connection request confirmation**

For updating the SSID / password or changing the name of the printer displayed on Wi-Fi Direct compatible device, see [Change Wireless Direct Connection Setting](#).

Connecting Smartphone/Tablet to Printer

1. Turn on Wi-Fi communication on Wi-Fi Direct compatible device.

For more on turning on Wi-Fi communication, see your device's instruction manual.

2. Select "DIRECT-XXXX-XX-XXXX" ("X" represents alphanumeric characters.) from list displayed on device.

▶▶▶ Note

- If "DIRECT-XXXX-XX-XXXX" does not appear on the list, wireless direct is not enabled.
See [Enable Wireless Direct](#) to enable wireless direct.
- You can change the name of the printer displayed on Wi-Fi Direct compatible devices.
See [Change Wireless Direct Connection Setting](#) as necessary.

3. Enter password on Wi-Fi Direct compatible device.

The device is connected to the printer.

▶▶▶ Note

- You can check the password set for the printer by the following method.



1. On the HOME screen, select  (**Network**).
 2. Select **Wireless Direct**.
 3. Select **Change password**.
 4. Select **Change manually**.
 5. Select **Show password**.
- If your Wi-Fi Direct compatible device is set to prioritize using Wi-Fi Direct and it is connecting to the printer, the printer displays a confirmation screen asking if you allow the device to connect to the printer.

Make sure the name on the touch screen is the same as that of your Wi-Fi Direct compatible device and select **Yes**.

Change Wireless Direct Connection Setting

1. On the HOME screen, select  (**Network**).

➔ [Home Screen Menu Composition](#)

2. Select **Wireless Direct**.

3. Change settings as necessary.

- To update the password for wireless direct

Select **Change password** to display the confirmation screen.

To check the updated password, select **Change manually > Show password**.

- To change the printer's name displayed on the Wi-Fi Direct compatible device

Select **Change network name (SSID)** to display the printer's name (the initial value is "DIRECT-XXXX-XX-XXXX") displayed on a Wi-Fi Direct compatible device.

Follow the procedure below to change the name.

1. Select the device name entry field on the touch screen.
 2. Enter device name (up to 32 characters).
 3. Select **OK** and confirm the entered device name.
 4. Select **OK**.
- To change the confirmation screen setting when a Wi-Fi Direct compatible device is connecting to the printer

Select **Connection request confirmation** to display the confirmation screen.

If you want the printer to display the screen to inform you a Wi-Fi Direct compatible device is connecting to the printer, select **Yes**.

▶▶▶ Important

- To prevent an unauthorized access, we recommend you should not change the setting from the default.

When you finished performing the settings, the printer returns to the **Wireless Direct settings** screen.

▶▶▶ Note

- If you change the wireless direct setting on the printer, also change the setting on the device.

Wired Connection

Follow the procedure below to setup a printer.

▶▶▶ Note

- Refer to the following for notes when connecting to a wired LAN.

➔ Notes on Wired Connection

1. Make sure printer is turned on before starting wired connection setup.

If the power is on, the **ON** lamp will be lit.

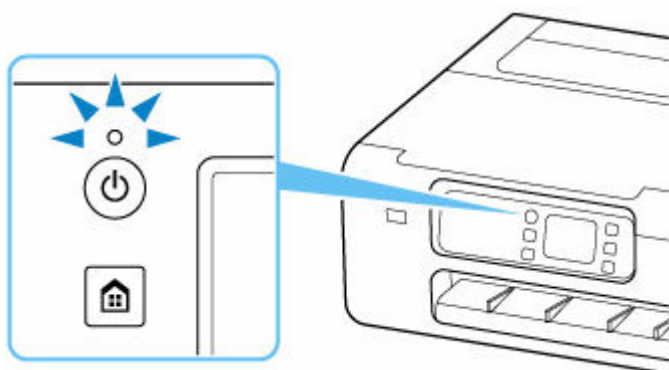

▶▶▶ Important

- If printer is performing cleaning, print head alignment, or other processes, wait for the process to finish, before starting setup.

2. Press the **HOME** button.

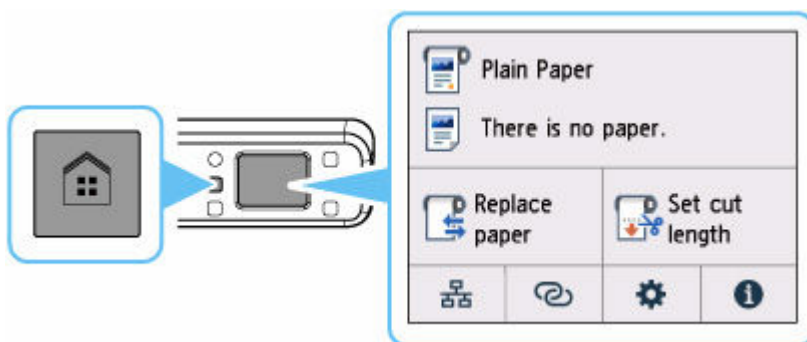

3. You will need an Ethernet cable (sold separately).

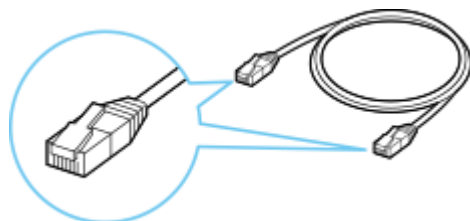

4. Connect the printer and a network device (router, etc.) with an Ethernet cable.

Do not connect to any other port.

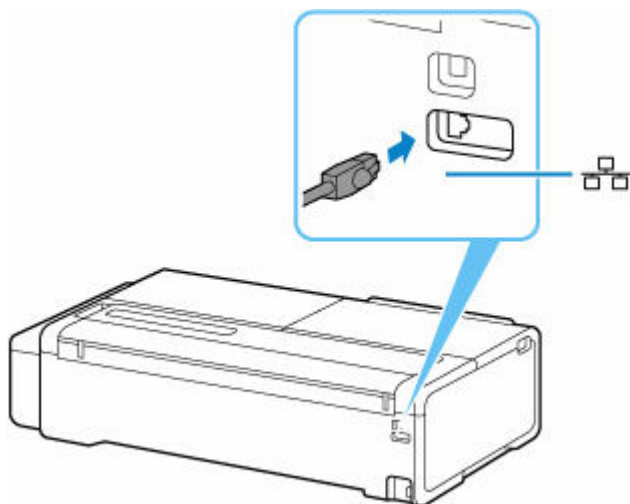

5. On the HOME screen, select the **Network** icon.

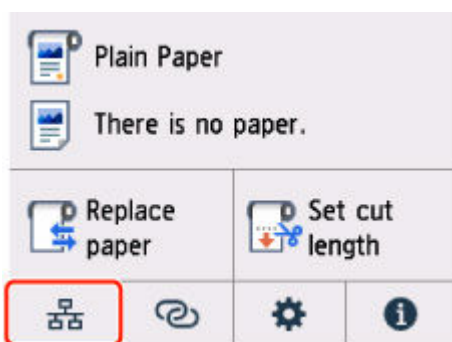

Depending on the current LAN status, the icon displayed on the button may differ.

➔ [Home Screen Menu Composition](#)

6. Select **Wired LAN**.

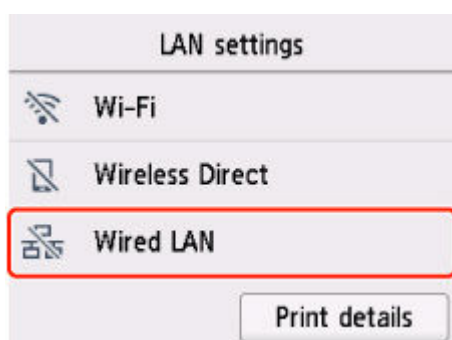

7. Select **Enable/disable Wired LAN**.



8. Select **Enable**.



9. Press the **HOME** button.

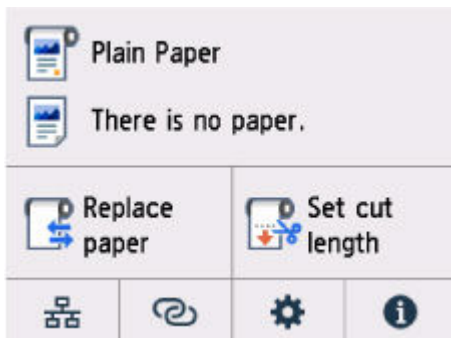



The network connection setup is now complete.

Once connection is complete,  appears on the screen.

If performing setup with software, return to the software and proceed with the installation.

Windows

Click  (or ) on the  taskbar at the bottom of the screen, follow the on-screen instructions to proceed with setup.

macOS

Click  on the  Dock at the bottom of the screen, and follow the on-screen instructions to proceed with setup.

USB Connection

Connect the printer to a computer using a USB cable.

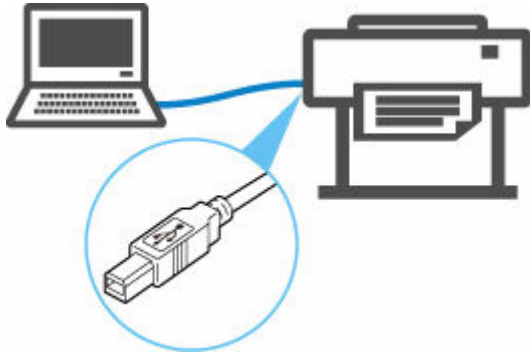

➔ What Is USB Cable?

In USB connection, the printer is connected one-on-one to the computer.

If your computer is connected to LAN, you can use the printer with other devices by enabling the sharing setting on your computer.

➤➤➤ Note

- You can connect the printer to a computer via USB even when the printer is already connected to another one via wired LAN.

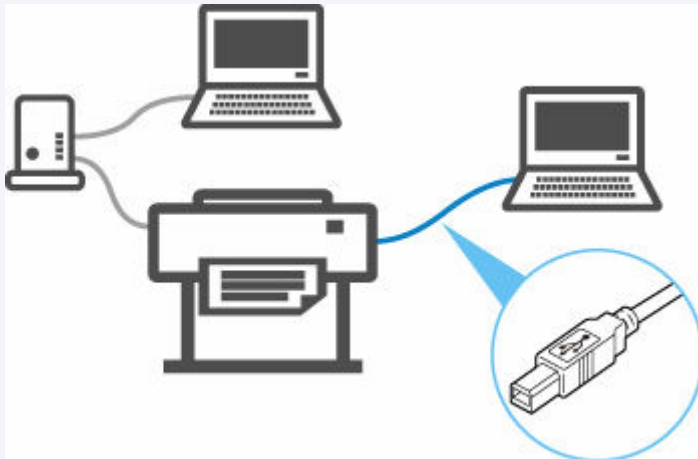

Default Network Settings

LAN Connection Defaults

Item	Default
Enable/Disable LAN	Wired LAN enabled
Network name (SSID)	BJNPSETUP
Wi-Fi security	Disable
IP address (IPv4)	DHCP
IP address (IPv6)	Auto setup
Set printer name *1	XXXXXXXXXXXX
Enable/disable IPv6	Enable
Enable/disable WSD	Disable
Timeout settings	15 minutes
Enable/disable Bonjour	Enable
Service name	Canon XX-NNNN *2
LPR protocol settings	Enable
Wi-Fi DRX settings	Enable
Wired LAN DRX settings	Enable

("XX" represents alphanumeric characters.)

*1 Default value depends on printer. To check value, use operation panel.

➔ [LAN settings](#)

*2 NNNN means your printer model name.

Wireless Direct Defaults

Item	Default
Network name (SSID)	DIRECT-abXX-YY-NNNN *1
Password	ZZZZZZZZZZ *2
Wi-Fi security	WPA2-PSK (AES)
Connection request confirmation	Displayed

*1 "ab" is specified at random and "XX" represents last two digits of printer's wireless MAC address. "YY" is alphanumeric, and "NNNN" means your printer model.

*2 The password is specified automatically when the printer is turned on for the first time.

Another Printer Found with Same Name

When the printer is found during setup, other printers with the same name may appear on the results screen.

Select a printer with checking the printer settings against those on detection result screen.

Check the printer's MAC address or serial to select the correct printer from the results.

▶▶▶ Note

- Serial number may not appear on result screen.

Check the printer's MAC address and the serial number by one of the following methods.

- Display on the touch screen.
 - MAC address
 - ➔ [LAN settings](#)
 - Serial number



(Information) >



System information.

- Print the network settings.
 - ➔ [Printing Network Settings](#)

Printing Network Settings

Use the operation panel to print the printer's current network settings.

Items to Prepare

At least 10 sheets of unused A4 size plain paper

▶▶ Important

- The network settings printout contains important information about your network. Handle it with care.

1. Load paper.

➔ [Loading Sheets in the Printer](#)

2. Select  (**Setup**) icon on HOME screen.

3. Select **Printer settings**.

4. Select **LAN settings**.

5. Select **Print details**.

6. Select **Yes** on displayed screen.

7. Select **ON** or **OFF** on displayed screen.

The printer starts printing network settings information.

The printed network settings information is as follows: (Some setting values are not displayed depending on the printer settings.)

Item Number	Item	Description	Setting
1	Product Information	Product information	–
1-1	Product Name	Product name	XXXXXXXX
1-2	ROM Version	ROM version	XXXXXXXX
1-3	Serial Number	Serial number	XXXXXXXX
2	Network Diagnostics	Network diagnostics	–
2-1	Diagnostic Result	Diagnostic result	XXXXXXXX
2-2	Result Codes	Result codes	XXXXXXXX
2-3	Result Code Details	Result code details	http://canon.com/ijnwt

3	Wireless LAN	Wireless LAN	Enable/Disable
3-2	Infrastructure	Infrastructure	Enable/Disable
3-2-1	Signal Strength	Signal strength	0 to 100 [%]
3-2-2	Link Quality	Link quality	0 to 100 [%]
3-2-3	Frequency	Frequency	XX (GHz)
3-2-4	MAC Address	MAC address	XX:XX:XX:XX:XX:XX
3-2-5	Connection	Connection status	Active/Inactive
3-2-6	SSID	SSID	Wireless LAN network name (SSID)
3-2-7	Channel	Channel	XXX (1 to 13)
3-2-8	Encryption	Encryption method	None/WEP/TKIP/AES
3-2-9	WEP Key Length	WEP key length (bits)	Inactive/128/64
3-2-10	Authentication	Authentication method	None/auto/open/shared/WPA-PSK/WPA2-PSK
3-2-11	TCP/IPv4	TCP/IPv4	Enable/Disable
3-2-12	IP Address	IP address	XXX.XXX.XXX.XXX
3-2-13	Subnet Mask	Subnet mask	XXX.XXX.XXX.XXX
3-2-14	Default Gateway	Default gateway	XXX.XXX.XXX.XXX
3-2-15	TCP/IPv6	TCP/IPv6	Enable/Disable
3-2-16	Link Local Address	Link local address	XXXX:XXXX:XXXX:XXXX XXXX:XXXX:XXXX:XXXX
3-2-17	Link Local Prefix Length	Link local prefix length	XXX
3-2-18	Stateless Address1	Stateless address 1	XXXX:XXXX:XXXX:XXXX XXXX:XXXX:XXXX:XXXX
3-2-19	Stateless Prefix Length1	Stateless prefix length 1	XXX
3-2-20	Stateless Address2	Stateless address 2	XXXX:XXXX:XXXX:XXXX XXXX:XXXX:XXXX:XXXX
3-2-21	Stateless Prefix Length2	Stateless prefix length 2	XXX
3-2-22	Stateless Address3	Stateless address 3	XXXX:XXXX:XXXX:XXXX XXXX:XXXX:XXXX:XXXX

3-2-23	Stateless Prefix Length3	Stateless prefix length 3	XXX
3-2-24	Stateless Address4	Stateless address 4	XXXX:XXXX:XXXX:XXXX XXXX:XXXX:XXXX:XXXX
3-2-25	Stateless Prefix Length4	Stateless prefix length 4	XXX
3-2-26	Default Gateway1	Default gateway 1	XXXX:XXXX:XXXX:XXXX XXXX:XXXX:XXXX:XXXX
3-2-27	Default Gateway2	Default gateway 2	XXXX:XXXX:XXXX:XXXX XXXX:XXXX:XXXX:XXXX
3-2-28	Default Gateway3	Default gateway 3	XXXX:XXXX:XXXX:XXXX XXXX:XXXX:XXXX:XXXX
3-2-29	Default Gateway4	Default gateway 4	XXXX:XXXX:XXXX:XXXX XXXX:XXXX:XXXX:XXXX
3-2-33	IPsec	IPsec setting	Active/Inactive
3-2-34	Security Protocol	Security method	ESP/ESP & AH/AH/Blank (Not selected)
3-2-35	Wireless LAN DRX	Discontinuous reception (wireless LAN)	Enable/Disable
3-3	Wireless Direct	Operation mode for Wireless Direct	Enable/Disable
3-3-1	MAC Address	MAC address	XX:XX:XX:XX:XX:XX
3-3-2	Connection	Connection status	Active/Inactive
3-3-3	SSID	SSID	Wireless Direct network name (SSID)
3-3-4	Password	Password	Wireless Direct password
3-3-5	Channel	Channel	3
3-3-6	Encryption	Encryption method	AES
3-3-7	Authentication	Authentication method	WPA2-PSK
3-3-8	TCP/IPv4	TCP/IPv4	Enable/Disable
3-3-9	IP Address	IP address	XXX.XXX.XXX.XXX
3-3-10	Subnet Mask	Subnet mask	XXX.XXX.XXX.XXX
3-3-11	Default Gateway	Default gateway	XXX.XXX.XXX.XXX
3-3-12	TCP/IPv6	TCP/IPv6	Enable/Disable

3-3-13	Link Local Address	Link local address	XXXX:XXXX:XXXX:XXXX XXXX:XXXX:XXXX:XXXX
3-3-14	Link Local Prefix Length	Link local prefix length	XXX
3-3-15	IPsec	IPsec setting	Active/Inactive
3-3-16	Security Protocol	Security method	ESP/ESP & AH/AH/Blank (Not selected)
3-3-17	Wireless LAN DRX	Discontinuous reception (wireless direct)	Enable/Disable
4	Wired LAN	Wired LAN	Enable/Disable
4-1	MAC Address	MAC address	XX:XX:XX:XX:XX:XX
4-2	Connection	Wired LAN status	Active/Inactive
4-3	TCP/IPv4	TCP/IPv4	Enable/Disable
4-4	IP Address	IP address	XXX.XXX.XXX.XXX
4-5	Subnet Mask	Subnet mask	XXX.XXX.XXX.XXX
4-6	Default Gateway	Default gateway	XXX.XXX.XXX.XXX
4-7	TCP/IPv6	TCP/IPv6	Enable/Disable
4-8	Link Local Address	Link local address	XXXX:XXXX:XXXX:XXXX XXXX:XXXX:XXXX:XXXX
4-9	Link Local Prefix Length	Link local prefix length	XXX
4-10	Stateless Address1	Stateless address 1	XXXX:XXXX:XXXX:XXXX XXXX:XXXX:XXXX:XXXX
4-11	Stateless Prefix Length1	Stateless prefix length 1	XXX
4-12	Stateless Address2	Stateless address 2	XXXX:XXXX:XXXX:XXXX XXXX:XXXX:XXXX:XXXX
4-13	Stateless Prefix Length2	Stateless prefix length 2	XXX
4-14	Stateless Address3	Stateless address 3	XXXX:XXXX:XXXX:XXXX XXXX:XXXX:XXXX:XXXX
4-15	Stateless Prefix Length3	Stateless prefix length 3	XXX
4-16	Stateless Address4	Stateless address 4	XXXX:XXXX:XXXX:XXXX

			XXXX:XXXX:XXXX:XXXX
4-17	Stateless Prefix Length4	Stateless prefix length 4	XXX
4-18	Default Gateway1	Default gateway 1	XXXX:XXXX:XXXX:XXXX XXXX:XXXX:XXXX:XXXX
4-19	Default Gateway2	Default gateway 2	XXXX:XXXX:XXXX:XXXX XXXX:XXXX:XXXX:XXXX
4-20	Default Gateway3	Default gateway 3	XXXX:XXXX:XXXX:XXXX XXXX:XXXX:XXXX:XXXX
4-21	Default Gateway4	Default gateway 4	XXXX:XXXX:XXXX:XXXX XXXX:XXXX:XXXX:XXXX
4-25	IPsec	IPsec setting	Active/Inactive
4-26	Security Protocol	Security method	ESP/ESP & AH/AH/Blank (Not selected)
4-27	Wired LAN DRX	Discontinuous reception (wired LAN)	Enable/Disable
5	Other Settings	Other settings	–
5-1	Printer Name	Printer name	Printer name (Up to 15 alphanumeric characters)
5-2	Wireless Direct Dev-Name	Device name for wireless direct	Device name for wireless direct (Up to 32 alphanumeric characters)
5-4	WSD Printing	WSD printing setting	Enable/Disable
5-5	WSD Timeout	Timeout	1/5/10/15/20 [min]
5-6	LPD Printing	LPD printing setting	Enable/Disable
5-7	RAW Printing	RAW printing setting	Enable/Disable
5-9	Bonjour	Bonjour setting	Enable/Disable
5-10	Bonjour Service Name	Bonjour service name	Bonjour service name (Up to 52 alphanumeric characters)
5-11	LLMNR	LLMNR setting	Enable/Disable
5-12	SNMP	SNMP setting	Enable/Disable
5-14	DNS Server	Obtain DNS server address automatically	Auto/Manual
5-15	Primary Server	Primary server address	XXX.XXX.XXX.XXX
5-16	Secondary Server	Secondary server address	XXX.XXX.XXX.XXX

5-17	Proxy Server	Proxy server setting	Enable/Disable
5-18	Proxy Address	Proxy address	XXXXXXXXXXXXXXXXXXXXXX
5-19	Proxy Port	Proxy port specification	1 to 65535
5-20	Cert. Fingerprt(SHA-1)	Certificate finger- print(SHA-1)	xxxxxxx xxxxxxxx xxxxxxxx xxxxxxx xxxxxxxx
5-21	Cert. Fin- gerprt(SHA-256)	Certificate finger- print(SHA-256)	xxxxxxx xxxxxxxx xxxxxxxx xxxxxxxx xxxxxxx xxxxxxxx xxxxxxxx xxxxxxxx

("XX" represents alphanumeric characters.)

Network Status and Troubleshooting

Check the network status referring to LAN setting information on the touch screen.

➔ [Printing Network Settings](#)

Network Status	What to Do
<p>Connected normally.</p> <p>If you are unable to print, see 1 on What to Do.</p>	<p>1. If you are unable to print, check the items below:</p> <ul style="list-style-type: none"> • whether the computer is connected to Wi-Fi • whether the firewall of your security software is enabled • whether a privacy separator, SSID separator, or Network separation function is enabled on your wireless router <p>If one of the above is enabled, disable it before setup.</p> <ul style="list-style-type: none"> • whether the network name (SSID) of the printer matches that of the router to connect <p>2. To change the network connection method (wired/wireless), change it on the printer's network setting screen.</p>
<p>Wi-Fi is disabled on the printer.</p>	<p>Perform printer setup following the instructions of the manual.</p>
<p>Wired LAN connection is disabled.</p>	<ul style="list-style-type: none"> • Make sure the printer is connected to the router with the LAN cable. <p>If the LAN cable is loose, connect the cable properly.</p> <p>If the LAN cable is connected to the WAN side of the router, connect the cable to the LAN side of the router.</p> <ul style="list-style-type: none"> • Make sure the network devices (e.g. hub or router) are turned on.
<p>IP address is not assigned.</p>	<ul style="list-style-type: none"> • If you specify the printer's IP address automatically, enable DHCP on the router. • If you specify the printer's IP address manually, the address is disabled because it is out of the valid range. You specified (0.0.0.0) as the IP address, for example. <p>Specify the valid IP address.</p>
<p>The default gateway is not specified.</p>	<p>Check the items below to communicate by hopping routers (e.g. using a cloud application).</p> <ul style="list-style-type: none"> • Make sure the device specified as the default gateway is turned on. • Specify the default gateway address correctly. <p>To check the default gateway, print out the network settings information.</p> <p>▶▶▶ Note</p> <ul style="list-style-type: none"> • For some printers, you can check the default gateway on the operation panel.
<p>Cannot connect to the specified network.</p>	<p>Check the status of the printer, network devices (e.g. wireless router), or smartphone/tablet.</p> <ul style="list-style-type: none"> • If they are turned off, turn them on. • Make sure wireless signal is strong. <p>Monitor signal status and move the printer and wireless router as necessary.</p> <ul style="list-style-type: none"> • The security key specified for the wireless router may not match that you entered. <p>The security key is case-sensitive.</p> <p>Enter the correct security key.</p>

<p>Make sure wireless signal is strong.</p>	<ul style="list-style-type: none"> • Make sure the printer is not placed too far away from the wireless router. • Monitor signal status and move the printer and wireless router as necessary.
<p>The number of connected clients reaches the upper limit.</p>	<ul style="list-style-type: none"> • Wireless Direct does not allow more than 5 devices to be connected. <p>If you add a device to connect, disconnect a device you do not use before adding the device.</p>
<p>The signal to noise ratio (S/N ratio) is low.</p>	<ul style="list-style-type: none"> • There is a lot of noise from other devices. <p>Move the printer apart from other devices.</p>
<p>A link local address is assigned.</p>	<ul style="list-style-type: none"> • Perform printer setup again. • The security key specified for the wireless router may not match that you entered. <p>The security key is case-sensitive.</p> <p>Enter the correct security key.</p>
<p>The specified network name (SSID) is left default value.</p>	<p>The network name (SSID) is not specified.</p> <p>Enter the network name (SSID) specified for the destination.</p>

Sharing the Printer on a Network (Windows)

When computers are used in a network environment, documents can be printed from multiple computers that share a single printer.

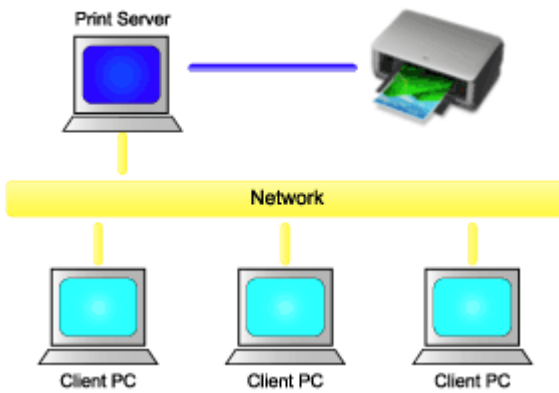

- [Setting Up a Shared Printer](#)

This section describes how to set up the print server and the client.

►►► Note

- The Windows versions of the computers connected to the network do not necessarily have to be the same.

Related Topic

- ➔ [Restrictions on Printer Sharing](#)

Setting Up a Shared Printer

On the print server, set up sharing of the printer driver. Then from the client, set up the connection to the print server.

1. [Install the printer driver](#) on the print server system

2. Display the **Devices and Printers** window

Select the **Control Panel** -> **Hardware and Sound (Hardware)** -> **Devices and Printers**.

The **Devices and Printers** window is displayed.

3. Click the icon for the model name of printer to be shared

Press the Alt key, and from the displayed **File** menu, select **Printer properties** -> **Sharing** tab.

»»» Important

- When starting up the software and performing install or uninstall, a confirmation or warning dialog box may appear.
This dialog box appears when administrative rights are required to perform a task.
When you are logged on to an administrator account, click **Yes** (or **Continue**, **Allow**) to continue.
Some applications require an administrator account to continue. In such cases, switch to an administrator account, and restart the operation from the beginning.

4. Set sharing

On the **Sharing** tab, check (or select) **Share this printer**, set the shared name as necessary, and then click **OK**.

5. If the print server and the client have different architectures (32 bit or 64 bit), install an additional driver

1. Display the **Devices and Printers**, **Printers**, or **Printers and Faxes** window.
2. Select the printer icon, click **Print server properties**, and select the **Drivers** tab.
3. Click **Add...**
4. When the **Add Printer Driver Wizard** window is displayed, click **Next**.
5. If the print server has a 32-bit architecture, select **x64**. If the print server has a 64-bit architecture, select **x86**. Then click **Next**.
6. Click **Have Disk...**
7. In the **Install From Disk** window, open the "Driver" folder of the downloaded printer driver, specify the "inf" file, and click **OK**.

»» Note

- If the printer server is 32-bit, specify it as "xxxxxxx3.INF". If it is 64-bit, specify it as "xxxxxxx6.INF".

8. Select the printer to be used, and click **Next**.

»» Note

- If an error message is displayed, select the other printer.

9. Click **Finish**

The setup on the print server system is complete. Next, set up the client systems.

6. On the client, open Explorer, and double-click the icon of the printer to be shared

7. Follow the window instructions, and install the printer driver

The setup on the client system is complete.

Even when you perform the setup on a different client, follow the same steps 6 and 7.

Restrictions on Printer Sharing

These are restrictions that apply when you are using a printer in a network environment. Check the restrictions for the environment you are using.

Restriction on setting up printer sharing

- If "ntprint.inf" is requested when you install the driver from **Add Printer**, specify the file as follows:
 1. Start Explorer on the print server and on the client with the different architecture, paste the following path in the address bar, and press Enter on the keyboard:
%windir%\system32\driverstore\
 2. Right-click the **FileRepository** folder, and click **Properties**.
 3. On the **Sharing** tab, click **Share**.
 4. In the message window displayed on the print server, specify "ntprint.inf_xxxxxxx" in the folder that was shared in step 3, and click **OK**.
If there are multiples copies, select the file with the latest update date and time.

Restrictions on sharing and using a printer

- A print completion message may be displayed. To disable the message display, follow the procedure below.
 1. In the **Control Panel** -> **Hardware and Sound (Hardware)** -> **Devices and Printers** window of the client system, select the printer, and click **Print server properties** on the command bar.
 2. Uncheck **Show informational notifications for network printers** on the **Advanced** tab, and then restart the computer.
- The bi-directional communication function is disabled and the correct printer status may not be recognized.
If a client user opens the printer driver properties and then clicks **OK** with the **Enable bidirectional support** check box cleared on the **Ports** tab, the bidirectional communication function of the print server may also be disabled.
In this case, check **Enable bidirectional support** check box on both the print server system and the client system.
- When you print from a client system, the following functions cannot be used.
 - The **Edit Using PosterArtist** feature of **Page Layout** in the **Layout** tab
- When the functions on the **Device Settings** tab cannot be set properly from a client system, they may be grayed out. In this case, change the settings from the print server.
When you change the settings of the print server, you should delete the icon of the shared printer from the client system, and then specify the shared settings again in the client system.
- If the same driver installed on the print server is also installed on the client, the network printer icon may be created automatically.
- If an error occurs when you print a document on a shared printer from a client, the error message of the Canon IJ status monitor is displayed on both the client and the print server. If a document is printed out normally, the Canon IJ status monitor is displayed only on the client.

Adjustments for Better Print Quality

- **Checking for Nozzle Clogging**
- **Cleaning the Print Head**
- **Deep Print Head Cleaning**
- **Automatic Adjustment to Straighten Lines and Colors**
- **Manual Adjustment to Straighten Lines and Colors**
- **Automatically Adjusting Different Colored Horizontal Streaks**
- **Manually Adjusting Different Colored Horizontal Streaks**
- **Adjusting Line Length**

Checking for Nozzle Clogging

If the print is blurred or has different color threading, print a nozzle check pattern to see if each nozzle of the print head is not clogged.

▶▶▶ Note

- If the remaining ink level is low, the nozzle check pattern will not be printed correctly. Refill the ink tanks whose ink is low.

➔ [Refilling Ink Tanks](#)

Items to Prepare

When Using Rolls

Roll at least 11.69 in. (297.0 mm) wide

When Using Sheets

One unused sheet of A4 or larger size paper

1. Load paper.

➔ [Loading Rolls in the Printer](#)

➔ [Loading Sheets in the Printer](#)

2. Select (**Setup**) on the HOME screen.

➔ [Home Screen Menu Composition](#)

3. Select **Maintenance**.

4. Select **Nozzle Check**.

5. Check message and select **Yes**.

6. Select **Roll paper** or **Top feed**

The nozzle check pattern will be printed and two pattern confirmation screens will appear on the touch screen.

7. Check the print result.

Check if there are missing lines in the pattern C or horizontal streaks in the pattern D.

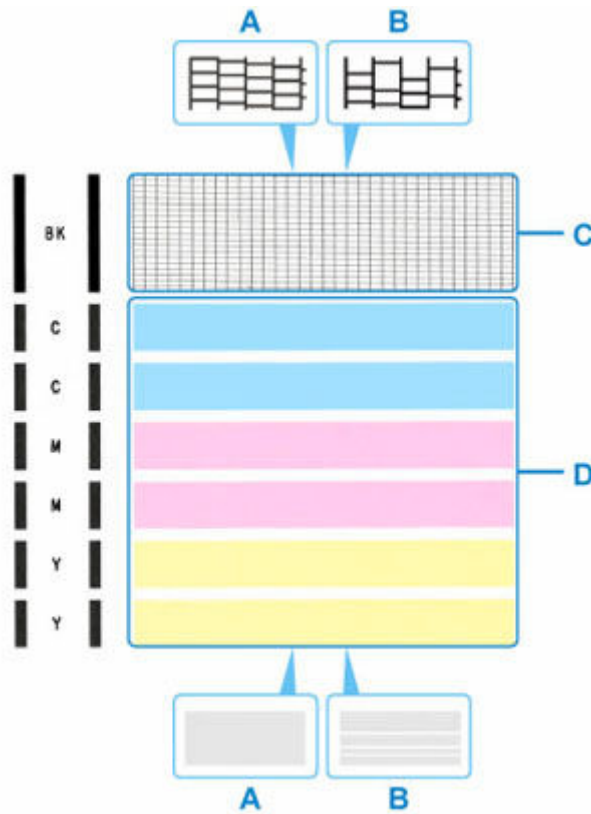

A: No missing lines/No horizontal streaks
 B: Lines are missing/Horizontal streaks are present

8. Select the pattern that is closer to the printed nozzle check pattern on the confirmation screen.

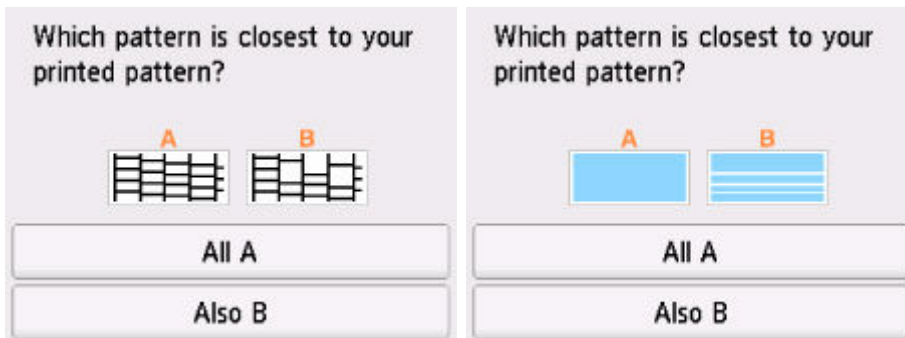

For A (no missing lines or no horizontal streaks) in both the pattern C and pattern D:

The cleaning is not required. Select **All A**, confirm the message, then select **OK**.

The screen will return to the **Maintenance** screen.

For B (lines are missing or horizontal streaks are present) in the pattern C or pattern D, or in both patterns:

The cleaning is required. Select **Also B**, then go to next step.

If the pattern D or any color in the pattern C is not printed:



(Example: Magenta pattern is not printed)

The cleaning is required. Select **Also B**, then go to next step.

9. Select **Yes** on the cleaning confirmation screen.

The printer starts cleaning the print head. This takes about 2 minutes.

►► Important

- Do not perform any other operations until the printer completes the cleaning of the print head.

10. Check message and select **Yes**.

11. Select **Roll paper** or **Top feed**.

A nozzle check pattern is printed and two pattern confirmation screens appear on the touch screen.

12. Repeat steps 7 through 11.

►► Important

- If there is no improvement after repeating the cleaning process twice, perform **Deep Cleaning**.

➔ [Deep Print Head Cleaning](#)

Cleaning the Print Head

Clean the print head if lines are missing or if horizontal streaks are present in the printed nozzle check pattern. Cleaning unclogs the nozzles and restores the print head condition. Cleaning the print head consumes ink, so clean the print head only when necessary.

»» Important

- When performing the print head cleaning, check the free space in the maintenance cartridge. If there is not enough free space, replace with the new maintenance cartridge. In the case of shortage of free space in the maintenance cartridge, a message is displayed and the cleaning cannot be performed.

➔ [Replacing the Maintenance Cartridge](#)

Items to Prepare

When Using Rolls

Roll at least 11.69 in. (297.0 mm) wide

When Using Sheets

One unused sheet of A4 or larger size paper

1. Load paper.

➔ [Loading Rolls in the Printer](#)

➔ [Loading Sheets in the Printer](#)

2. Select (**Setup**) on the HOME screen.

➔ [Home Screen Menu Composition](#)

3. Select **Maintenance**.

4. Select **Cleaning**.

5. Check message and select **Yes**.

6. Select **All colors**, **Color** or **BK**.

The printer starts cleaning the print head.

Do not perform any other operations until the printer completes the cleaning of the print head. This takes about 2 minutes.

7. Check message and select **Yes**.

8. Select **Roll paper** or **Top feed**.

The nozzle check pattern will be printed.

9. Check the print result.

Check if there are missing lines in the pattern C or horizontal streaks in the pattern D.

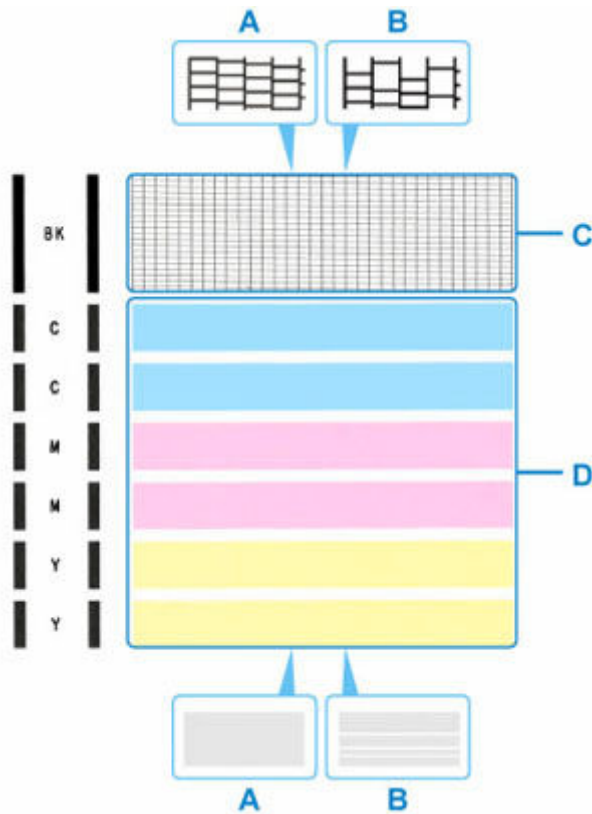

- A: No missing lines/No horizontal streaks
- B: Lines are missing/Horizontal streaks are present

10. Select the pattern that is closer to the printed nozzle check pattern on the confirmation screen.

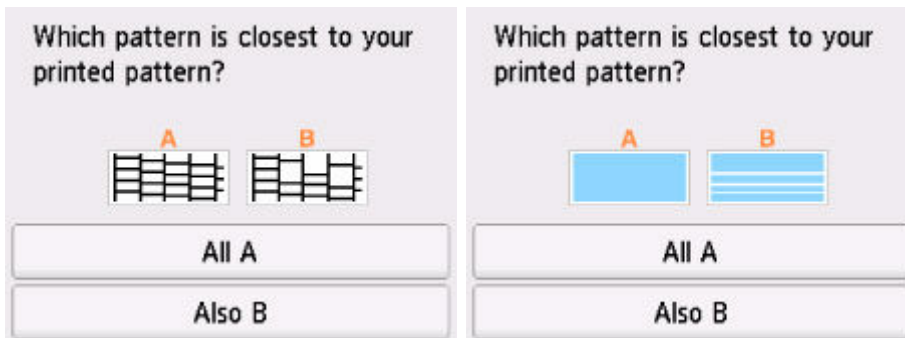

For A (no missing lines or no horizontal streaks) in both the pattern C and pattern D:

The cleaning is not required. Select **All A**, confirm the message, then select **OK**.

The screen will return to the **Maintenance** screen.

For B (lines are missing or horizontal streaks are present) in the pattern C or pattern D, or in both patterns:

The cleaning is required. Select **Also B**, then go to next step.

If the pattern D or any color in the pattern C is not printed:



(Example: Magenta pattern is not printed)

The cleaning is required. Select **Also B**, then go to next step.

11. Select **Yes** on the cleaning confirmation screen.

The printer starts cleaning the print head. This takes about 2 minutes.

»» Important

- Do not perform any other operations until the printer completes the cleaning of the print head.

12. Check message and select **Yes**.

13. Select **Roll paper** or **Top feed**.

A nozzle check pattern is printed and two pattern confirmation screens appear on the touch screen.

14. Repeat steps 9 through 13.

»» Important

- If there is no improvement after repeating the cleaning process twice, perform **Deep Cleaning**.

➡ [Deep Print Head Cleaning](#)

Deep Print Head Cleaning

If print quality does not improve by the standard cleaning of the print head, clean the print head deeply. Cleaning the print head deeply consumes more ink than the standard cleaning of the print head, so clean the print head deeply only when necessary.

▶▶▶ Important

- When performing the print head deep cleaning, check the free space in the maintenance cartridge. If there is not enough free space, replace with the new maintenance cartridge. In the case of shortage of free space in the maintenance cartridge, a message is displayed and the cleaning cannot be performed.

➔ [Replacing the Maintenance Cartridge](#)

Items to Prepare

When Using Rolls

Unused roll at least 11.69 in. (297.0 mm) wide

When Using Sheets

One unused sheet of A4 or larger size paper

1. Load paper.

➔ [Loading Rolls in the Printer](#)

➔ [Loading Sheets in the Printer](#)

2. Select (Setup) on the HOME screen.

➔ [Home Screen Menu Composition](#)

3. Select Maintenance.

4. Select **Deep Cleaning**.

5. Check message and select **Yes**.

6. Select **All colors**, **Color** or **BK**.

The printer starts cleaning the print head deeply. This takes about 2 to 3 minutes.

▶▶▶ Important

- Do not perform any other operations until the printer completes the deep cleaning of the print head.

7. Check message and select **Yes**.

8. Select **Roll paper** or **Top feed**.

The nozzle check pattern will be printed.

9. When the completion message appears, select **OK**.

10. Check the print result.

Check if there are missing lines in the pattern C or horizontal streaks in the pattern D.

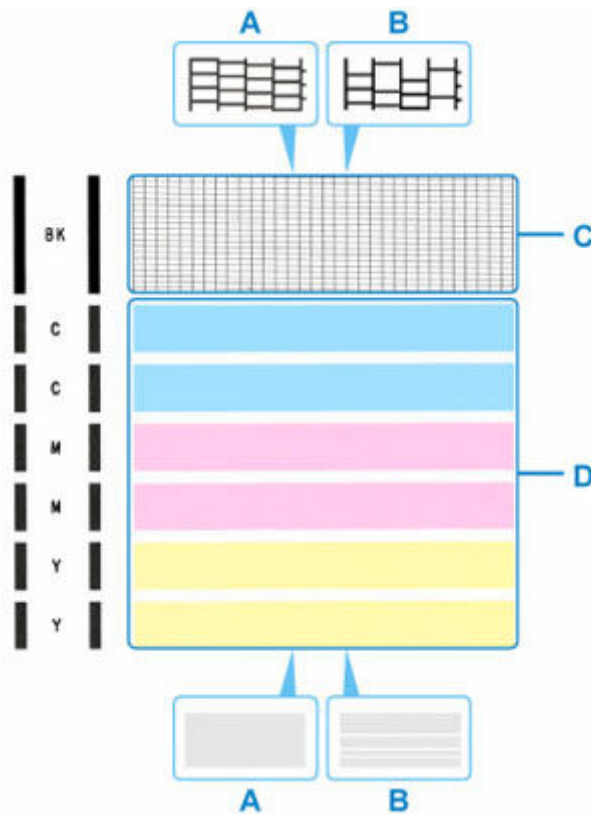

A: No missing lines/No horizontal streaks

B: Lines are missing/Horizontal streaks are present

»» Important

- If the problem is not resolved, turn off the power and clean the print head deeply again after 24 hours. Do not unplug the power cord when turning off the power.
- If there is no improvement after repeating **Deep Cleaning** twice, perform **Replace Ink in Print Head**.
 - ➔ Replacing the Ink in the Print Head

Automatic Adjustment to Straighten Lines and Colors

If vertical lines on the printed document are misaligned or a color shift occurs, adjust the print head position.

When **Print Head Alignment - Auto** is performed, the adjustment pattern will be printed and the print head position is automatically adjusted based on the print result.



►► Important

- Since the adjustment result depends on the type of paper, adjust with the paper used for printing.
- Paper with high transparency, and photo paper with a glossy finish cannot be used.

►► Note

- If the remaining ink level is low, the print head alignment sheet will not be printed correctly. Refill the ink tanks whose ink is low.

➔ [Refilling Ink Tanks](#)

Items to Prepare

When Using Rolls

Roll at least 11.69 in. (297.0 mm) wide

1. Load paper.

➔ [Loading Rolls in the Printer](#)

►► Important

- Make sure to match the paper loaded in the printer with the paper type setting in the printer. If the loaded paper is different from the paper type setting in the printer is different, the print head will not be adjusted correctly.

2. Select (**Setup**) on the HOME screen.

➔ [Home Screen Menu Composition](#)

3. Select **Maintenance**.

4. Select **Print Head Alignment - Auto**.

5. Check message and select **Yes**.

An adjustment pattern is printed and the print head position is automatically adjusted.

6. When the completion message appears, select **OK**.

»» Note

- If the print results are still not satisfactory after adjusting the print head position as described above, adjust the print head position manually.
 - ➔ [Manual Adjustment to Straighten Lines and Colors](#)
- If adjusting the print head with special paper does not produce the expected results, try again with different paper, or manually adjust the print head.
 - ➔ [Manual Adjustment to Straighten Lines and Colors](#)
- To print and check the current head position adjustment values, select **Print the Head Alignment Value** on the **Maintenance** screen.

Manual Adjustment to Straighten Lines and Colors

If vertical lines on the printed document are misaligned or a color shift occurs, adjust the print head position. When **Print Head Alignment - Manual** is performed, the adjustment pattern will be printed. Check the print result and enter the setting value.



Important

- Since the adjustment result depends on the type of paper, adjust with the paper used for printing.

Note

- Using automatic print head adjustment is recommended.
 - ➔ [Automatic Adjustment to Straighten Lines and Colors](#)

Items to Prepare

When Using Rolls

Roll at least 11.69 in. (297.0 mm) wide

When Using Sheets

Two sheets of A4 / Letter / A3 size paper

1. Load paper.

- ➔ [Loading Rolls in the Printer](#)
- ➔ [Loading Sheets in the Printer](#)

2. Select (**Setup**) on the HOME screen.

- ➔ [Home Screen Menu Composition](#)

3. Select **Maintenance**.

4. Select **Print Head Alignment - Manual**.

5. Check message and select **Yes**.

6. Select **Roll paper** or **Top feed**.

The print head alignment pattern will be printed.

7. When **Did the patterns print correctly?** appears, make sure pattern was printed correctly, and if so, select **Yes**.
8. Check message and select **Next**.
9. Examine first patterns and select **A**. In column A, find pattern in which stripes are least noticeable, and then select the number of that pattern.

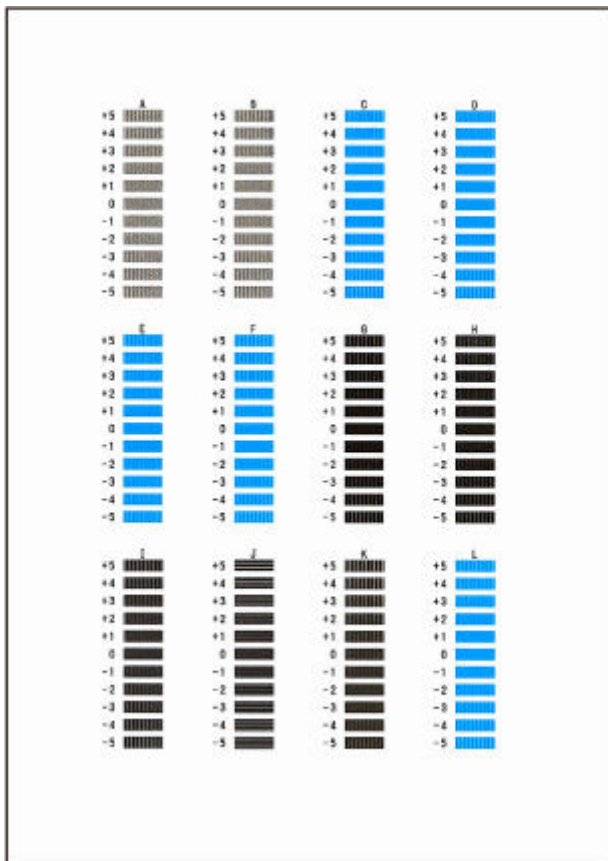

►►► **Note**

- If all patterns look different, choose the pattern in which vertical stripes are least noticeable.

Subtle vertical stripes



Noticeable vertical stripes



- If all patterns look different, choose the pattern in which horizontal stripes are least noticeable.

Subtle horizontal stripes



Noticeable horizontal stripes



10. Repeat these steps until you have finished entering pattern numbers for columns B to L, and then select **OK**.

11. Check message and select **OK**.

The second set of patterns is printed.

12. Examine second patterns and select **M**. In column M, find pattern in which stripes are least noticeable, and then select the number of that pattern.

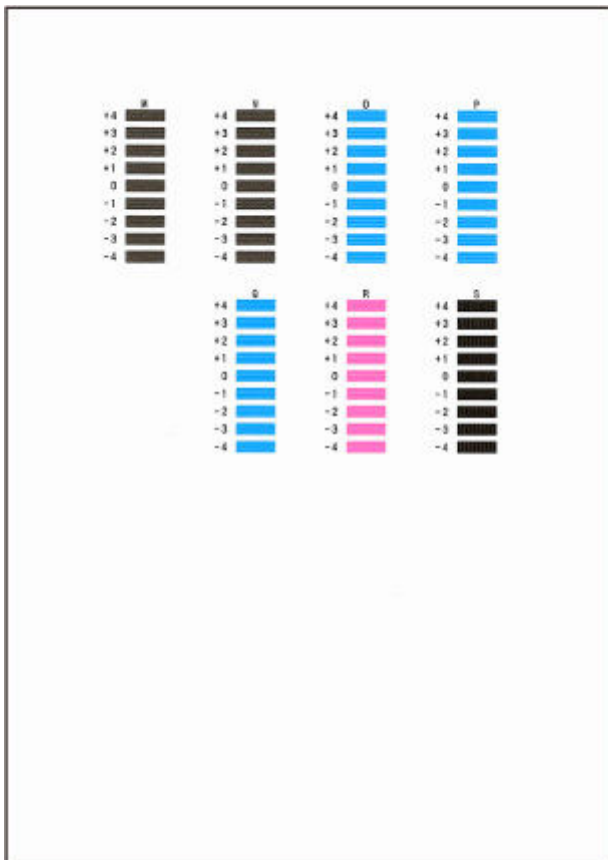

13. Repeat these steps until you have finished entering pattern numbers for columns N to S, and then select **OK**.

14. When confirmation message appears, select **OK**.

Automatically Adjusting Different Colored Horizontal Streaks

If printed images are affected by banding in different colors across the sheet, execute **Adjust print quality** for automatic adjustment of the paper feed amount.

The printer prints and reads a test pattern for automatic adjustment of the feed amount.

Important

- When using highly transparent media, use manual adjustment.
➔ [Manually Adjusting Different Colored Horizontal Streaks](#)

Note

- We recommend executing the adjustment if you have changed the paper type or paper size.
- Always check the **Set priority** values.
➔ [Paper feed adjustment](#)
- Use **Adjust feed length** to ensure that lines in CAD drawings are printed at exactly the right length.
➔ [Adjusting Line Length](#)
- This may take some time, depending on the type of paper.

Items to Prepare

When Using Rolls

Roll at least 11.69 in. (297.0 mm) wide

Follow the procedure below to adjust.

1. Load paper.

➔ [Loading Rolls in the Printer](#)

2. Select  (**Setup**) on the HOME screen.

➔ [Home Screen Menu Composition](#)

3. Select  **Maintenance**.

4. Select **Paper feed adjustment**.

5. Select **Adjust print quality**.

6. Check message and select **OK**.

7. Select **Auto**.

8. Select **Roll paper** to adjust.

A test pattern is printed for adjustment and adjustment is finished.

▶▶▶ Note

- Depending on the type of paper, horizontal streaks may not improve. If the horizontal streaks are not improved, adjust it manually.

➡ [Manually Adjusting Different Colored Horizontal Streaks](#)

Manually Adjusting Different Colored Horizontal Streaks

If printed images are affected by banding in different colors, execute **Adjust print quality** for adjustment of the paper feed amount.

Use manual adjustment with highly transparent media.

Manual adjustment requires you to enter an adjustment value after a test pattern is printed.

▶▶▶ Note

- We recommend executing the adjustment if you have changed the paper type or paper size.
- Always check the **Set priority** values.
- Use **Adjust feed length** to ensure that lines in CAD drawings are printed at exactly the right length.

➔ [Adjusting Line Length](#)

Items to Prepare

When Using Rolls

Roll at least 11.69 in. (297.0 mm) wide

Follow the procedure below to adjust.

1. Load paper.

➔ [Loading Rolls in the Printer](#)

▶▶▶ Important

- Always make sure the loaded paper matches the type of paper specified. Adjustment cannot be completed correctly unless the loaded paper matches the settings.

2. Select  (**Setup**) on the HOME screen.

➔ [Home Screen Menu Composition](#)

3. Select  **Maintenance**.

4. Select **Paper feed adjustment**.

5. Select **Adjust print quality**.

6. Check message and select **OK**.

7. Select **Manual**.

8. Select **Roll paper** to adjust.

Test pattern A is printed for manual adjustment.

9. Examine test pattern A for adjustment. Determine pattern in which banding is least noticeable.

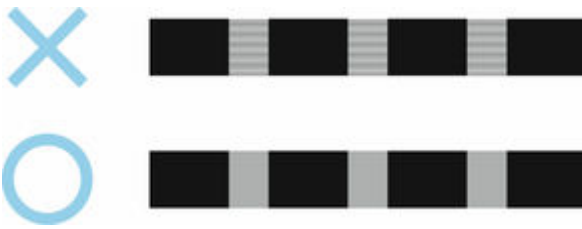

▶▶▶ Note

- If banding seems least noticeable in two patterns but you cannot decide which one is better, choose an intermediate value. For example, choose 11 if you cannot decide whether pattern 10 or 12 is better.

10. Select number you decided.

Test pattern B is printed for manual adjustment.

11. Examine test pattern B for adjustment. Determine pattern in which banding is least noticeable.

12. Select number you decided.

The adjustment value is now registered, and adjustment is complete.

Adjusting Line Length

To ensure that lines in CAD drawings are printed at exactly the right length, use **Adjust feed length** to adjust the amount that paper is advanced.

There are two options in **Adjust feed length** : **Print alignment pattern** and **Change adjustment values**.

▶▶▶ Note

- We recommend executing the adjustment if you have changed the paper type or paper size.
- Always check the **Set priority** values before adjustment.

Items to Prepare

When Using Rolls

- Roll at least 11.69 in. (297.0 mm) wide
- High-precision ruler

Follow the procedure below to adjust.

1. Load paper.

➔ [Loading Rolls in the Printer](#)

▶▶▶ Important

- Always make sure the loaded paper matches the type of paper specified.
Adjustment cannot be completed correctly unless the loaded paper matches the settings.

2. Select (**Setup**) on the HOME screen.

➔ [Home Screen Menu Composition](#)

3. Select **Maintenance**.

4. Select **Paper feed adjustment**.

5. Select **Adjust feed length**.

6. Select **Print alignment pattern** or **Change adjustment values**.

- If you select **Print alignment pattern**:

The test pattern is printed for you to measure the scale and calculate the discrepancy.

The scale bar prints "Millimeter" in 50 mm increments and "Inch" in 1-inch increments.

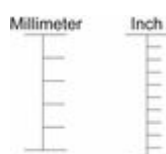

- If you select **Change adjustment values**:

No test pattern is printed.

Instead, you will measure a document already printed to determine the discrepancy.

7. Select amount of discrepancy.

If the scale is shorter than the actual size, use a positive setting value. If it is longer, use a negative value. The feed amount can be adjusted in 0.02% increments.

Maintenance and Consumables

► Replacing Consumables

- Refilling Ink Tanks
- Checking Ink Level
- Replacing the Print Head
- Checking the Remaining Maintenance Cartridge Capacity
- Replacing the Maintenance Cartridge

► Cleaning the Printer

- Cleaning the Printer Exterior
- Cleaning Inside the Printer
- Cleaning Document Platen and Document Cover
- Cleaning Paper Feed Rollers
- Performing Bottom Plate Cleaning

► Performing Maintenance Functions from Your Computer (Windows)

- Cleaning the Print Heads
- Printing a Nozzle Check Pattern

► Performing Maintenance Functions from Your Computer (macOS)

- Opening Remote UI for Maintenance
- Cleaning the Print Heads
- Printing a Nozzle Check Pattern

► Other Maintenance

- Preparing to Transfer the Printer
- Reinstalling the Printer
- Firmware update

Replacing Consumables

- **Refilling Ink Tanks**
- **Checking Ink Level**
- **Replacing the Print Head**
- **Checking the Remaining Maintenance Cartridge Capacity**
- **Replacing the Maintenance Cartridge**

Refilling Ink Tanks

When remaining ink cautions or errors occur, the message will appear on the touch screen to inform you of the error. In this state, the printer cannot print. Check the remaining amount of ink and refill the ink if necessary.

▶▶▶ Note

- For information on how to check the remaining ink level, see "Checking Ink Level".
➔ [Checking Ink Level](#)
- For precautionary notes on handling ink bottles, see "Notes on ink bottles".
➔ [Notes on ink bottles](#)

Refilling Procedure

When you refill ink tanks, follow the steps below.

▶▶▶ Important

- Please ensure the printer remains flat after initial setup and is NOT turned upside down or on its side, as ink in the printer may leak.

1. Check that printer is turned on.

➔ [Checking that Power Is On](#)

2. Open the ink tank cover (A).

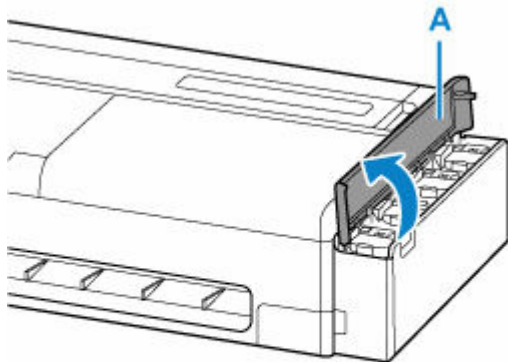

3. Open the ink tank inner cover (B) of the ink tank to be refilled.

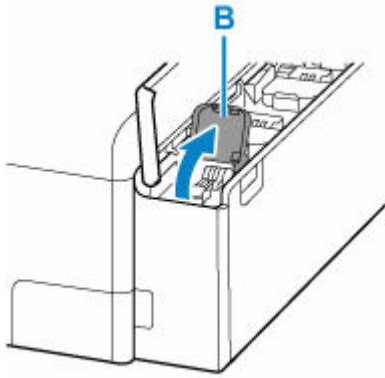

4. Open the tank cap (C).

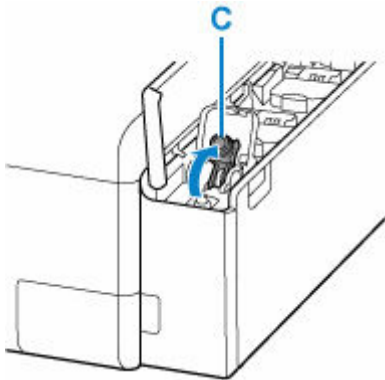

»» Important

- Carefully open the tank cap of the ink tank. Ink on the inside of the tank cap may spatter when opening it.

5. Hold the ink bottle upright and gently twist the bottle cap (D) to remove.

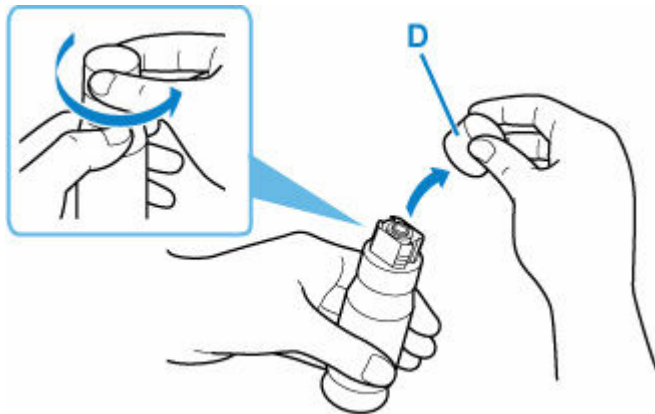

»» Important

- Do not shake the ink bottle. Ink may spatter when opening the cap.

6. Refill the ink tank.

Aligning the ink bottle's tip with the ink tank's inlet (E), slowly stand the bottle upside down, and push the bottle into the inlet.

The ink tank is refilled. Support the bottle with your hand so that it does not fall.

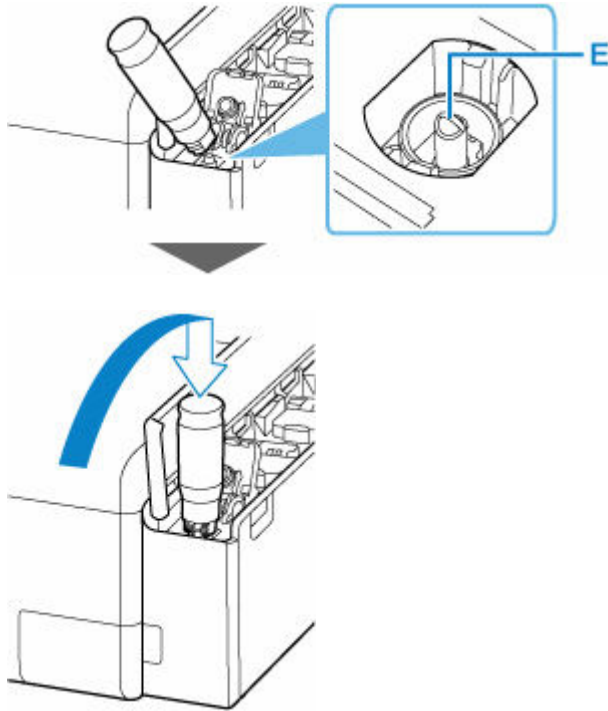

►► Important

- Make sure that each color of ink tanks is filled with corresponding color of ink bottles.
- If ink does not pour into the ink tank, slowly remove and insert the ink bottle.
- Pouring stops automatically when the ink tank is full.

►► Note

- You can check the ink status from the touch screen.

7. When ink refilling is complete,remove the ink bottle from the inlet.

Hold up the ink bottle slightly and remove the bottle from the inlet while slowly tilting it.

►► Important

- Do not leave ink bottles in ink tanks.
- Close the bottle cap of the ink bottle completely and store the ink bottle upright.
- Discard empty ink bottles in compliance with local laws and regulations regarding disposal of consumables.

8. Close the tank cap of the ink tank.

Make sure the tank cap is completely inserted.

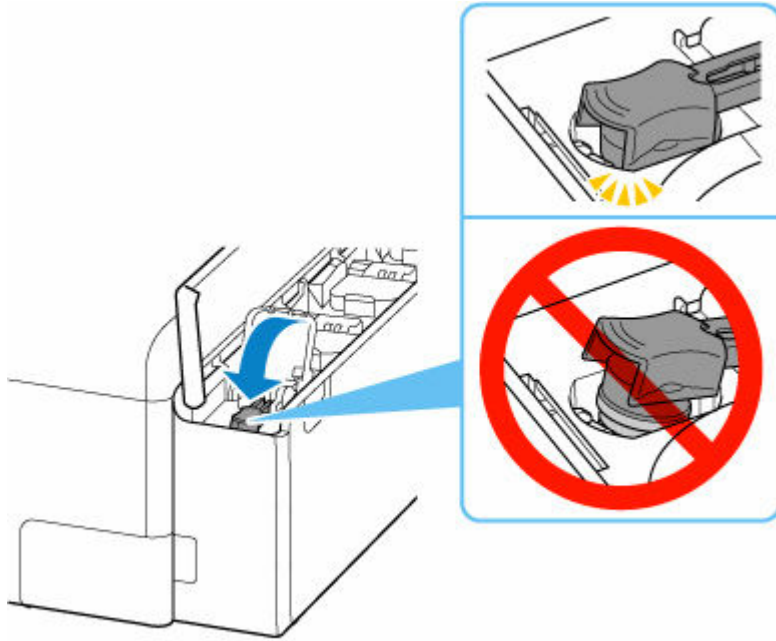

9. Close the ink tank inner cover completely.

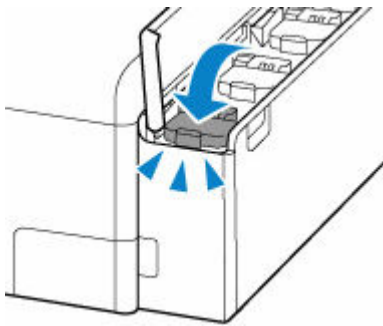

10. Close the ink tank cover.

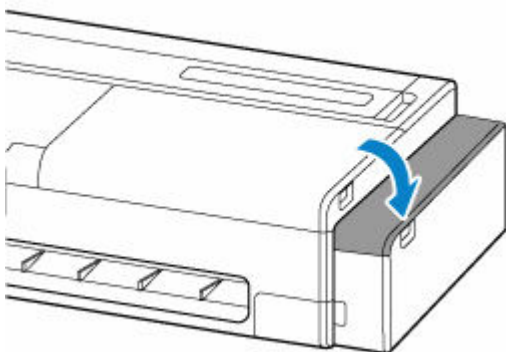

►►► **Note**

- If the error message appears on the touch screen after the ink tank cover is closed, take appropriate action.

Notes on ink bottles

►► Important

- Keep out of reach of children.
- Do not drink ink.
- If ink is accidentally licked or swallowed, rinse out your mouth or drink one or two glasses of water and obtain medical advice immediately. If ink gets into your eyes, flush them with water right away, and obtain medical advice immediately.
- If ink gets on your skin, wash the area with soap and water immediately. If irritation to your skin persists, obtain medical advice immediately.
- When you store ink bottles, close bottle caps completely and place bottles in standing position. If the ink bottles are laid down, ink may leak.
- When refilling ink tanks, take sufficient care to prevent ink from spattering onto surroundings.
- Ink may stain clothes or other belongings permanently. Washing may not remove ink stains.
- Do not use ink bottles and ink contained therein except to refill tanks of printers specified by Canon.
- Do not leave ink bottles in areas exposed to high temperature, such as near fire or a heater or in a car. Bottles may warp and cause ink leakage or ink may become poor quality.
- Do not subject ink bottles to impacts. Ink bottles may be damaged or bottle caps may come off by such impact, and ink may leak.
- Do not transfer ink to other containers. This may result in accidental ingestion, inappropriate use, or poor ink quality.
- Do not mix ink with water or other ink. This may damage the printer.
- Once an ink bottle has been opened, do not leave it with bottle cap off. Ink will dry out, possibly preventing proper operation of the printer when an ink tank is refilled using this bottle.
- To obtain the optimum print quality, it is recommended to refill the ink about once a year until the ink level display on the operation panel shows that the ink level is full.

►► Note

- Color ink may be consumed even when printing a black-and-white document or when black-and-white printing is specified. Every ink is also consumed in the standard cleaning and deep cleaning of the print head, which may be necessary to maintain the performance of the printer.

When ink runs low, promptly refill it.

➔ [Ink Tips](#)

Checking Ink Level

You can check the remaining amount of ink on the touch screen.



1. Select  (**Information**) on the HOME screen.

➔ [Home Screen Menu Composition](#)

2. Select  **Estimated ink levels.**

The **Current estimated ink levels** screen is displayed.



When the ink level is low,  is displayed above the ink level on the touch screen, and  is displayed when ink runs out.

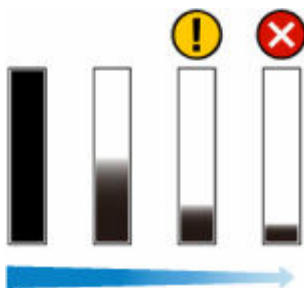

▶▶▶ Important

- Before performing large-format printing that consumes a large amount of ink, it is recommended to refill the ink until the ink level display shows that the ink level is full.

➔ [Refilling Ink Tanks](#)

▶▶▶ Note

- When a message appears instructing you to check the remaining ink level, or when performing head cleaning that consumes a large amount of ink, check the remaining ink level and refill ink as necessary.

➔ [Refilling Ink Tanks](#)

- To ensure you receive premium print quality and to help protect your print head, a certain amount of ink remains in the ink tank when the printer indicates to refill the ink tank. The estimated page yields of the ink bottle do not include this amount.
- Ink flows from the ink tanks to the inside of the printer. Ink may seem to run out fast due to this procedure when you start using the printer or after transporting it.
- Select **Ink model no.** > **Order ink now** for information on where to purchase ink.

Replacing the Print Head

If the touch screen indicates to replace the print head or if instructed to do so by your Canon dealer, replace the print head.

Compatible Print Head

For details on compatible print head, see [Print Head](#).

Precautions When Handling Print Head

Take the following precautions when handling the print head.

Caution

- For safety, keep print head out of the reach of children.
- If ink is accidentally ingested, contact a physician immediately.
- Do not touch the print head immediately after printing. The print head becomes extremely hot, and there is a risk of burns.

Important

- There may be ink around the nozzles of the print head you remove. Handle the print head carefully during replacement. The ink may stain clothing.
- Do not open the print head pouch until immediately before installation. After removing the print head from the pouch, install it right away. If the print head is left as is after the pouch is opened, the nozzles may dry out, which may affect printing quality.

How to Replace Print Head

Caution

- When replacing the print head immediately after printing, wait a few minutes before replacing it. The metal parts of the print head become hot during printing, and there is a risk of burns from touching these parts.

Important

- Your hands may become dirty during print head replacement. Use the gloves provided in the box with the new print head for replacement.

Note

- Refill the ink tanks when ink levels are low.
 - ➔ [Refilling Ink Tanks](#)
- Prepare a new maintenance cartridge when the remaining capacity of the maintenance cartridge is low.
 - ➔ [Replacing the Maintenance Cartridge](#)

1. Select  (**Setup**) on the HOME screen.

➔ [Home Screen Menu Composition](#)

2. Select  **Maintenance**.

3. Select **Head Replacement**.

4. Check message and select **Start**.

Draining ink from the print head starts. Draining ink takes about 3 minutes.

▶▶▶ Important

- When the cover is ready to be opened, instructions will be displayed on the touch screen. Do not open the cover before these instructions are displayed.

5. Open the scanning unit / cover (TC-20M) or the access cover on the left (TC-20).

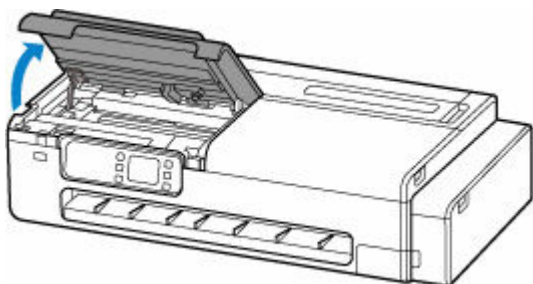

6. If the print head locking cover and print head lock lever are dirty, use a damp cloth that you have wrung out completely to wipe them clean.

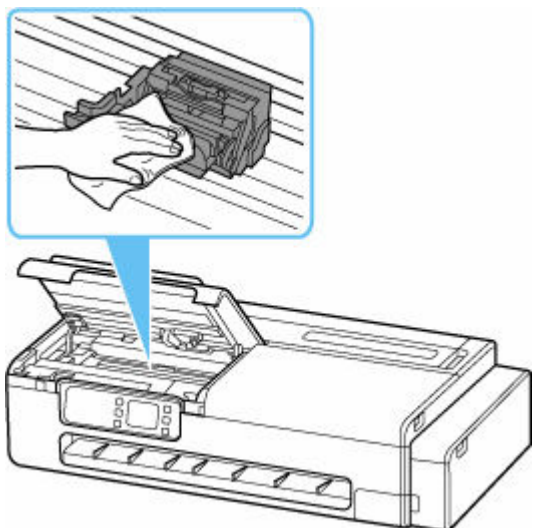

▶▶▶ Important

- Do not touch the linear scale (A) and carriage rail (B). Touching these may cause malfunction.

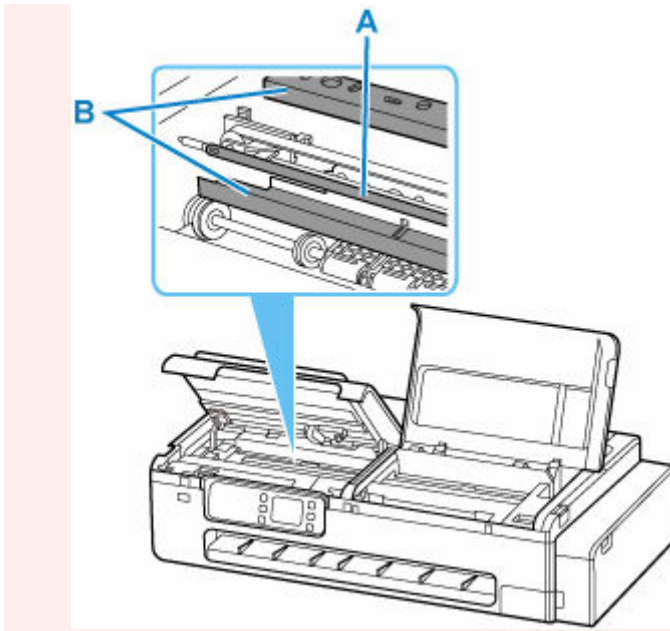

- Do not use tissue paper, paper towels, rough-textured cloth, or similar materials for cleaning so as not to scratch the surface.

7. Open print head lock lever firmly toward the front while holding its center (C) with your fingertip.

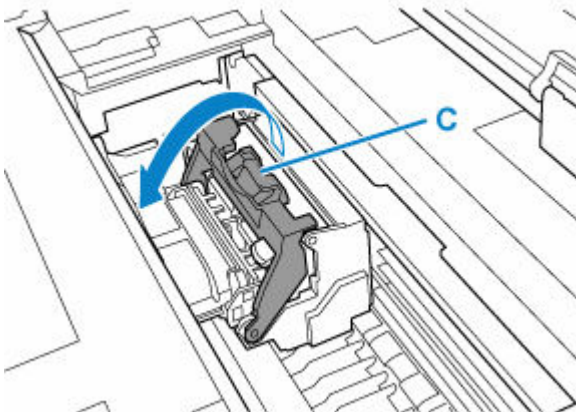

8. Grab grip (D) and open print head locking cover.

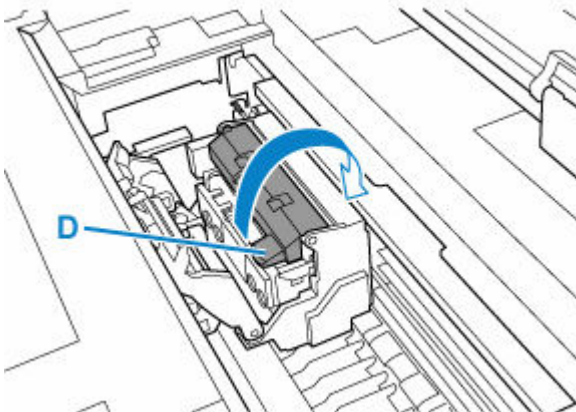

9. Grab grips (E), remove print head, and then select **OK**.

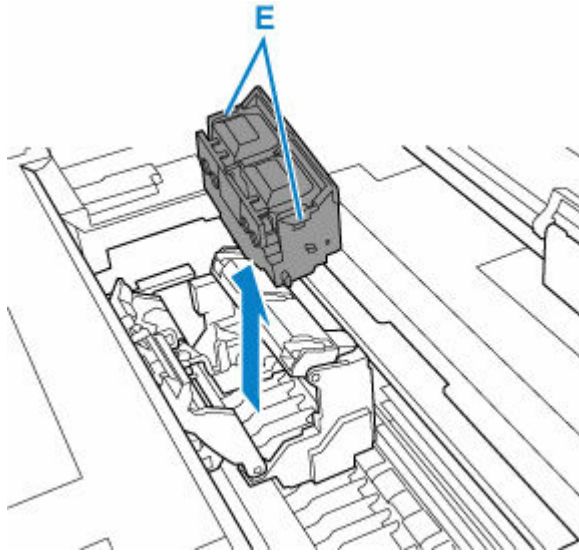

▶▶▶ Important

- Never touch the metal contacts of the carriage. Furthermore, do not allow any dirt or debris to become adhered to the metal contacts of the carriage. These may damage the printer.

▶▶▶ Note

- Dispose of the used print head in accordance with local regulations.

10. Remove print head that was in case from pouch.

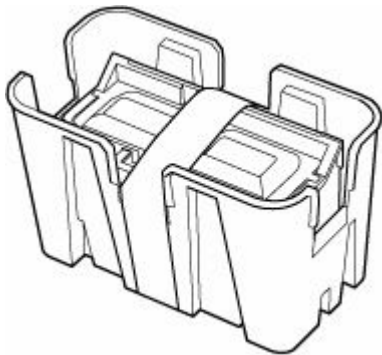

11. Remove tape used to secure print head.

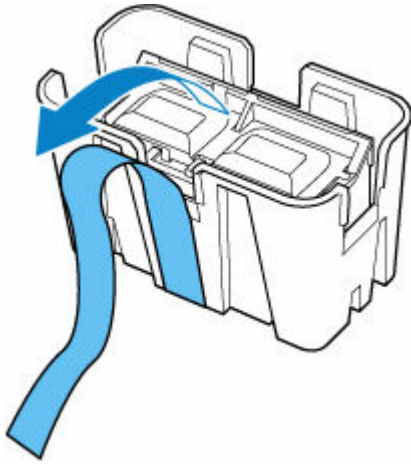

12. Hold the left and right grips, and remove the print head from the case.

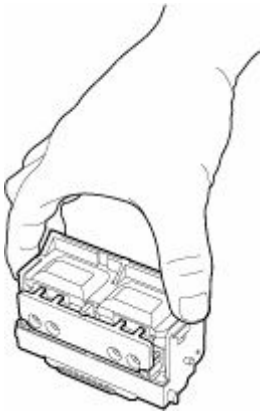

►► Important

- Always carry the print head by holding its right and left grips. Never touch nozzle (F) or metal contacts (G). This may damage the print head and affect printing quality.
- Never touch the ink holes (H). This may affect printing quality.

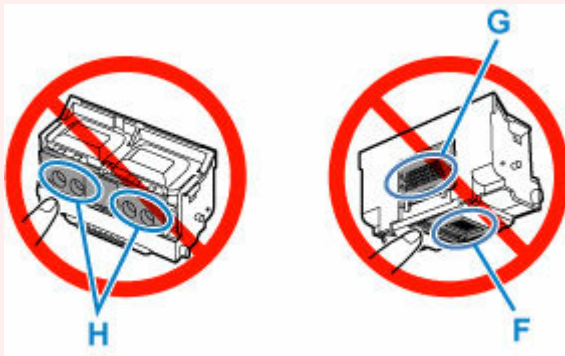

- The print head contains ink to protect the nozzle. If ink accidentally spills, wipe off the ink with a dry cloth.
- If you need to put a print head somewhere temporarily before installation, do not set it down with the nozzles and metal contacts facing down. If the nozzles or metal contacts are damaged, it may affect the printing quality.

13. Turn ink holes (H) toward the front and insert print head into carriage.

Insert the print head all the way into the carriage, while taking care to keep the ink supply unit from touching the carriage.

When inserting the print head into the carriage, make sure that the print head lock lever is firmly opened toward the front of the printer.

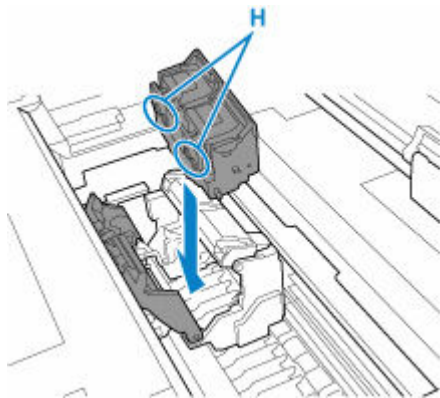

Important

- Do not force the print head. The carriage may be damaged.

14. Grasp tab (D) of print head locking cover and lower it to front to lock print head.

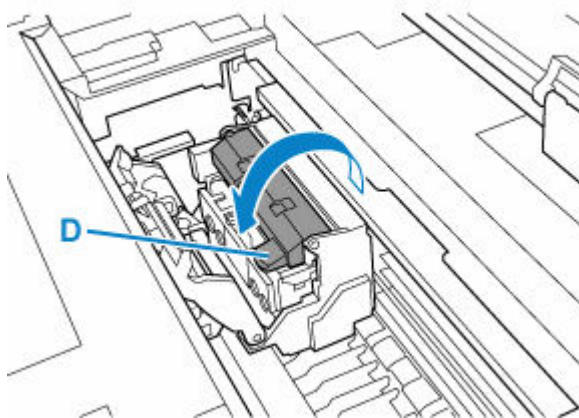

15. While holding center part (C) of print head lock lever, lower it toward back.

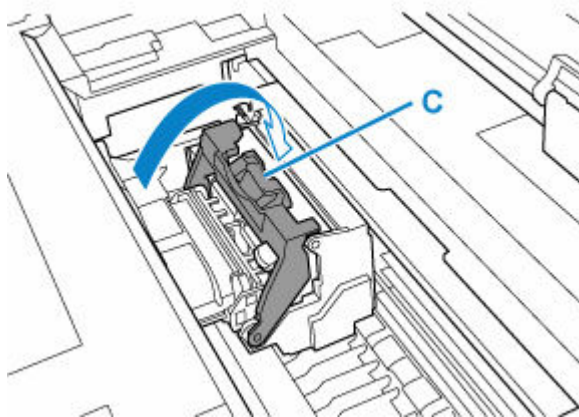

16. Close the scanning unit / cover (TC-20M) or the access cover on the left (TC-20).

To close the scanning unit / cover, hold it up once, then take it down gently.

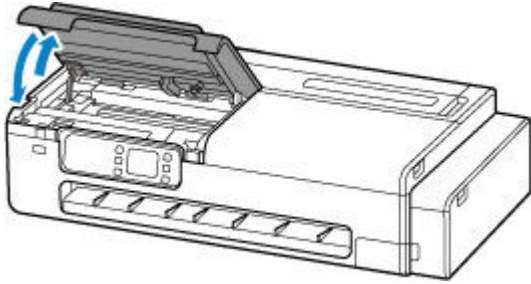

Ink now fills the print head. It takes about 7 minutes.

⚠ Caution

-
- When closing the scanning unit / cover, be careful not to get your fingers caught.
-

➤➤ Important

- While ink is being filled, definitely do not remove the maintenance cartridge. Ink may leak out.

Checking the Remaining Maintenance Cartridge Capacity

1. Select  (**Information**) on the HOME screen.

➔ [Home Screen Menu Composition](#)

2. Select  **Maintenance cart. info..**

The **Maintenance cartridge usage** screen appears.

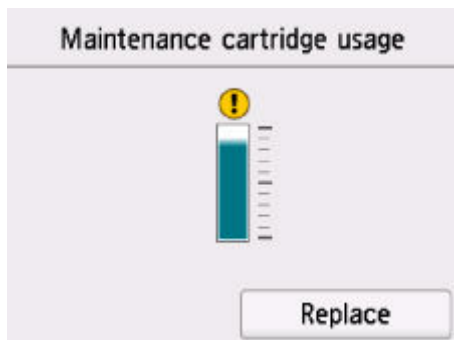

When  appears on the touch screen, the maintenance cartridge is nearly full. Prepare a new one.

»» Note

- To replace the maintenance cartridge, select **Replace**.

➔ [Replacing the Maintenance Cartridge](#)

Replacing the Maintenance Cartridge

Compatible Maintenance Cartridges

For details on compatible maintenance cartridge, see [Maintenance Cartridge](#).

Precautions When Handling Maintenance Cartridge

Take the following precautions when handling the maintenance cartridge.

Caution

- For safety, keep maintenance cartridge out of the reach of children.
- If ink is accidentally ingested, contact a physician immediately.

Important

- If the displayed message indicates that the maintenance cartridge is nearly full, promptly obtain a new one. If the maintenance cartridge becomes full, an error message is displayed and the printer stops working until it is replaced with a new one.
- Do not remove the maintenance cartridge except to replace it. Ink may leak out.
- Do not remove a maintenance cartridge during initialization immediately after turning on the printer, during print head cleaning, while ink is being drawn out, or during initialization immediately after replacing the maintenance cartridge.

The maintenance cartridge may become damaged or ink may leak out.

- To prevent ink from leaking from a used maintenance cartridge, avoid dropping the cartridge or storing it at an angle. Otherwise, ink may leak and cause stains.
- Handle the maintenance cartridge carefully during replacement. The ink may stain clothing.

How to Replace a Maintenance Cartridge

If a message indicates you should replace a maintenance cartridge, check the message details and go to step 6.

1. Select  (**Information**) on the HOME screen.

➔ [Home Screen Menu Composition](#)

2. Select  **Maintenance cart. info..**

3. Select **Replace**.

4. Select **Yes**.

5. Check message and select **OK**.

Instructions for the maintenance cartridge replacement procedure appear on the touch screen.

6. Open box, and remove plastic bag and maintenance cartridge.

»» Important

- Do not touch the terminal (A) or opening (B) of the maintenance cartridge.

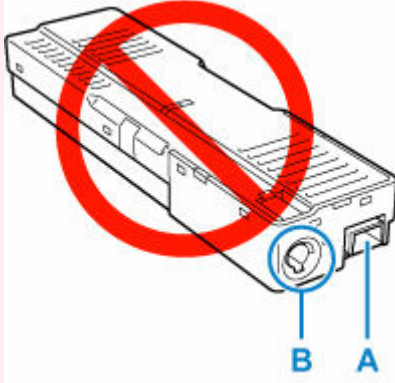

7. Open the maintenance cover.

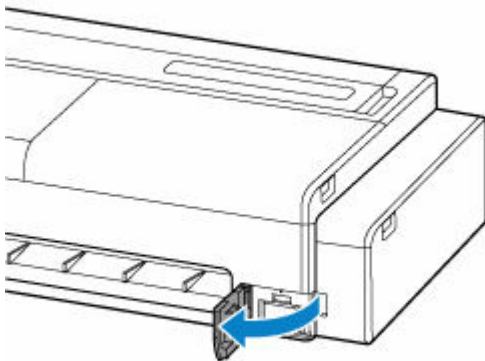

8. Pull out the maintenance cartridge.

Hold the upper portion of the maintenance cartridge with your hands so that its bottom does not touch the floor or desk.

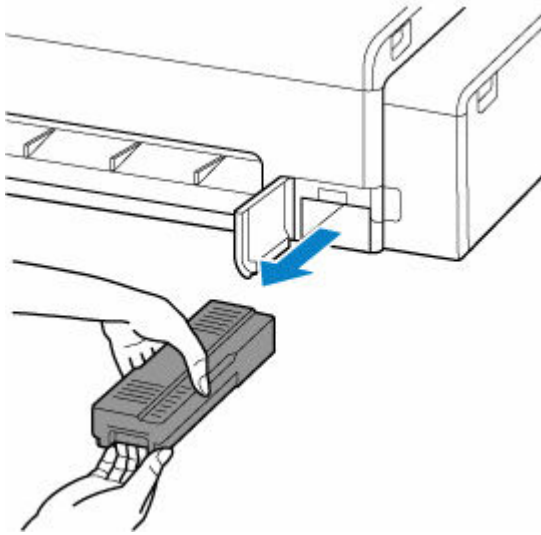

▶▶▶ Important

- A used maintenance cartridge is heavy. Always grasp the cartridge firmly and keep the cartridge level during removal. If you drop a used maintenance cartridge or store it at an angle, ink may leak and cause stains.

9. Put used maintenance cartridge in supplied plastic bag and store on flat surface.

▶▶▶ Important

- Always put the used maintenance cartridge back in the box and store the box on a flat surface.
- Be careful not to drop or place the removed maintenance cartridge on a desk or something. Dirt on the bottom may adhere to it or the ink inside may be scattered.
- Do not turn the removed maintenance cartridge upside down to prevent leakage of ink.



- Put the used one immediately into the plastic bag attached to the new maintenance cartridge and seal the bag by tying the opening tightly to prevent the ink from leaking.

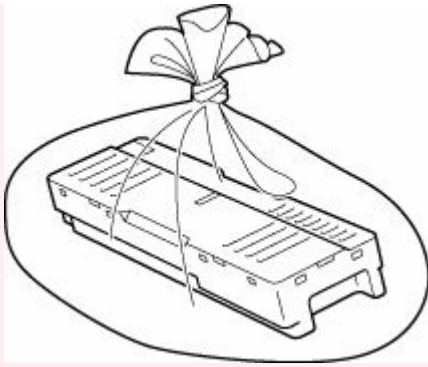

- Do not put your hands inside the printer, as ink may adhere to your hands.

6. Wipe away any soiling on the maintenance cover.

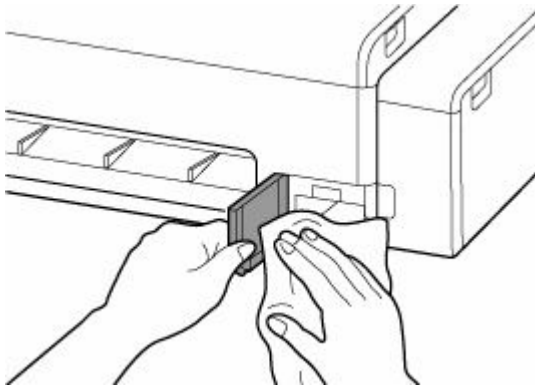

»» Important

- When wiping the maintenance cover, support the left side of the cover.

7. Keeping the new maintenance cartridge level, insert it all the way in.

The maintenance cartridge is initialized.

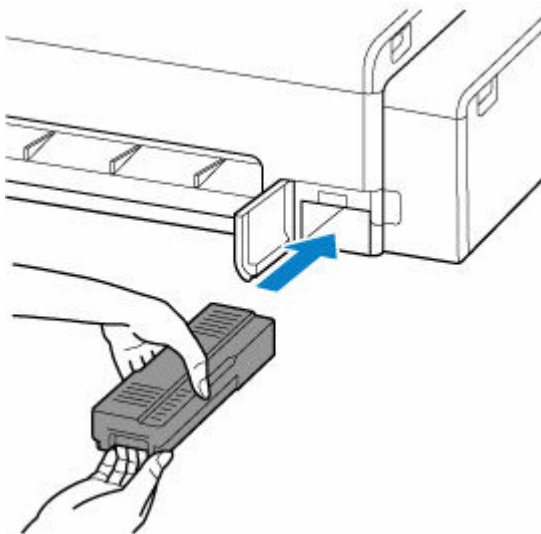

»» Important

- Do not remove the maintenance cartridge during initialization immediately after replacing the maintenance cartridge. The maintenance cartridge may become damaged.

8. Close the maintenance cover.

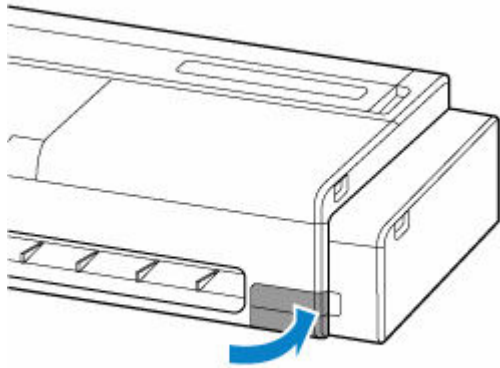

Cleaning the Printer

- **Cleaning the Printer Exterior**
- **Cleaning Inside the Printer**
- **Cleaning Document Platen and Document Cover**
- **Cleaning Paper Feed Rollers**
- **Performing Bottom Plate Cleaning**

Cleaning the Printer Exterior

Clean the printer regularly to maintain better printing quality and help prevent problems.

To ensure a comfortable working environment, clean the printer exterior about once a month.

1. Turn printer off.

➔ [Turning off the printer](#)

2. Unplug power cord from outlet.

⚠ Caution

- Always turn off the printer and unplug the power cord before cleaning or maintenance. Accidentally leaving the printer on poses a risk of injury if you touch moving parts inside the printer.

3. Wring out soft cloth with water or watered-down neutral detergent, and use it to wipe off dirt.

Clean the printer exterior and the power cord plug.

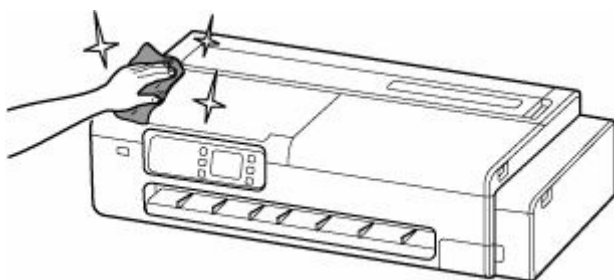

⚠ Warning

- Never use flammable solvents such as alcohol, benzine, or thinner. If these substances come into contact with electrical components inside the printer, there is a risk of fire or electrical shock.

➤➤➤ Important

- If the output guide is dirty, it may soil the edge of the paper when the paper is cut. We recommend cleaning the output guide even if it does not appear dirty, because it may actually be covered with paper dust.
 - ➔ [Cleaning Inside the Printer](#)
- Do not use tissue paper, paper towels, rough-textured cloth, or similar materials for cleaning so as not to scratch the surface.
- When neutral detergent is used, be sure to wipe off the detergent with soft cloth with water.

4. After cleaning, dry with a soft dry cloth.

5. Plug power cord into outlet.

Cleaning Inside the Printer

Clean inside the printer about once a month to maintain better printing quality and help prevent problems.

Also clean inside the printer in the following situations to ensure optimal operation.

- If the printed surface or the underside of paper is dirty after printing
- When a roll paper runs out
- After printing on small paper
- After printing on paper that generates a lot of cutting debris
- After changing the roll paper
- After printing on paper that generates a lot of paper dust

»» Important

- If the platen inside the printer becomes dirty, it may soil the underside of paper. We recommend cleaning the platen after printing on small paper.
- If the output guide is dirty, it may soil the edge of the paper when the paper is cut. We recommend cleaning the output guide even if it does not appear dirty, because it may actually be covered with paper dust.
- Cleaning may not be performed if there is paper in the cleaning area. Remove the paper.

1. Select  (Setup) on the Home Screen.

➔ [Home Screen Menu Composition](#)

2. Select  **Maintenance**.

3. Select **Platen cleaning**.

4. Select **Yes**.

»» Important

- When the cover is ready to be opened, instructions will be displayed on the touch screen. Do not open the cover before these instructions are displayed.

5. Open the access cover on the right side of the printer.

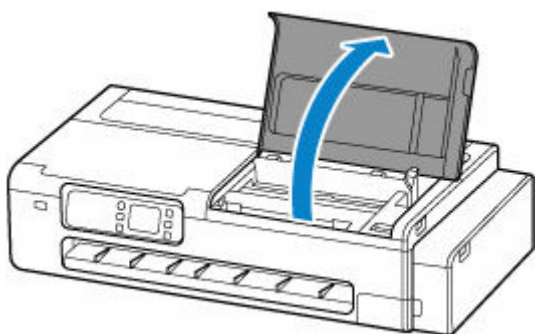

Important

- Do not touch the linear scale (A) or carriage rail (B). Touching these may cause malfunction.

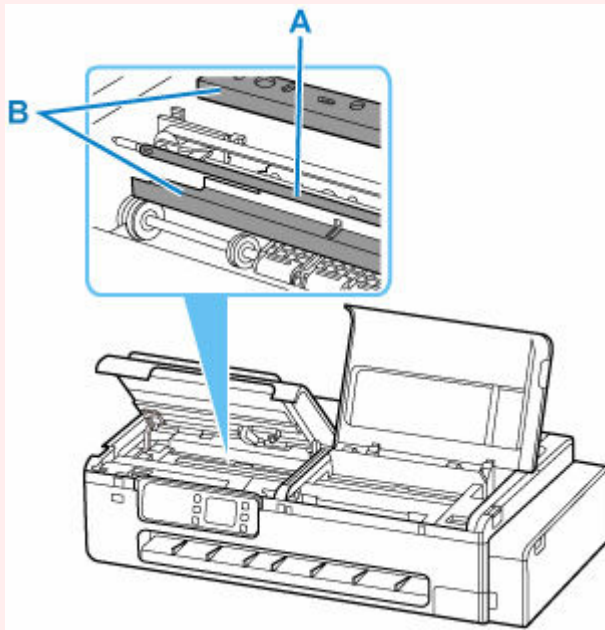

6. Clean the inside of the right side of the printer with a well wrung-out damp cloth.

Wipe off ink stains and paper dust (such as cutting scraps) on the platen (C), paper retainer (D), and output guide (E).

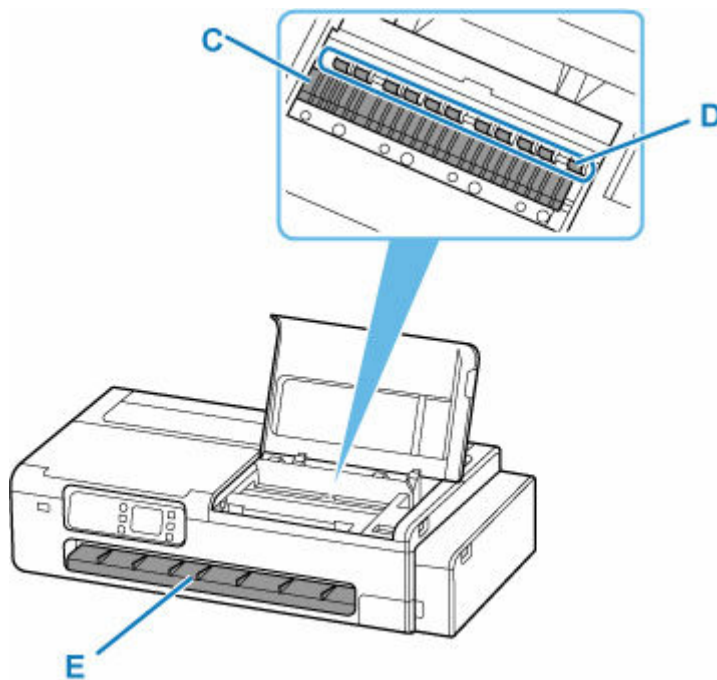

Warning

- Never use flammable solvents such as alcohol, benzene, or thinner. If these substances come into contact with electrical components inside the printer, there is a risk of fire or electrical shock.

»» Important

- Do not use a dry cloth to wipe the inside of the printer. This may create a static charge, which may attract dust and affect the printing quality.
- Do not use tissue paper, paper towels, rough-textured cloth, or similar materials for cleaning so as not to scratch the surface.
- If the protruding part of the platen is badly dirty, gently wipe off the ink stain on the protruding part with a cotton swab.

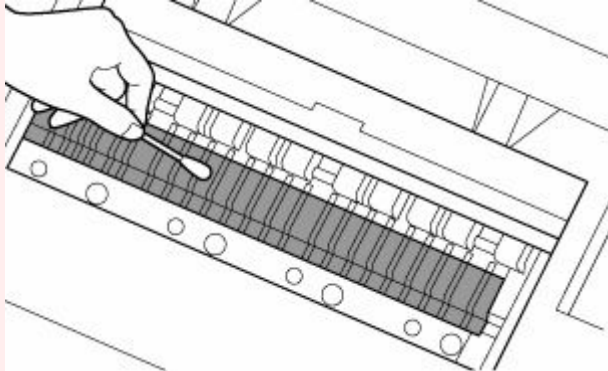

7. After wiping off the inside of the right side of the printer, select **OK**.

8. Close the access cover on the right side of the printer.

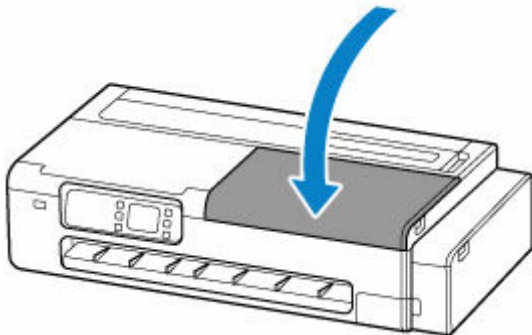

»» Important

- When the cover is ready to be opened, instructions will be displayed on the touch screen. Do not open the cover before these instructions are displayed.

9. Open the scanning unit / cover (TC-20M) or the access cover on the left (TC-20).

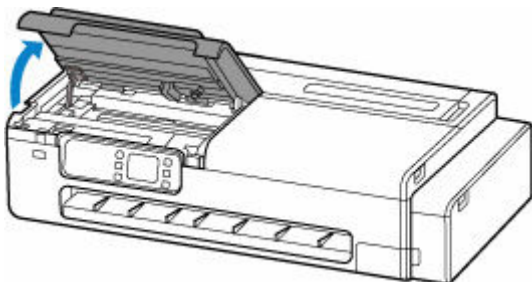

10. Clean the inside of the left side of the printer with a well wrung-out damp cloth.

Follow the same procedure for cleaning the inside of the left side of the printer as for cleaning the right side.

11. After wiping off the inside of the left side of the printer, select **OK**.

12. Close the scanning unit / cover (TC-20M) or the access cover on the left (TC-20).

To close the scanning unit / cover, hold it up once, then take it down gently.

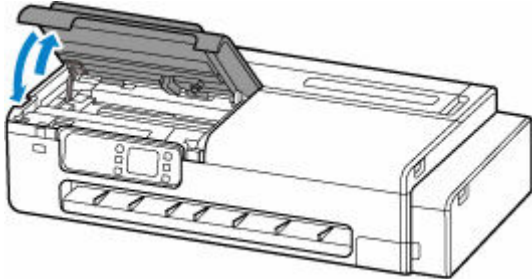

⚠ Caution

-
- When closing the scanning unit / cover, be careful not to get your fingers caught.
-

If the printed document is still dirty after performing these operations, the part that cannot be wiped off may be dirty. The dirt may be removed by passing a blank sheet of paper, so perform the following operations.

- If the roll paper is dirty, perform **Set cut length** several times.
 - ➔ [Set cut length \(feeds and cuts paper rolls by a specified length\)](#)
- If the sheet is dirty, perform **Bottom Plate Cleaning**.
 - ➔ [Performing Bottom Plate Cleaning](#)

Cleaning Document Platen and Document Cover

This section is for TC-20M only.

▶▶▶ Important

- Be sure to turn off the power and unplug the power cord before cleaning the printer.
- Do not use tissue paper, paper towels, rough-textured cloth, or similar materials for cleaning so as not to scratch the surface.
- Never use volatile liquids such as thinners, benzine, acetone, or any other chemical cleaner to clean the printer, as this may cause a malfunction or damage the surface of the printer.

Use a soft, dry cloth that is clean and lint-free.

Gently wipe off any dirt or dust on the glass surface of the document platen (A) and the area on the back of the document cover that touches the glass surface (B).

Wipe the glass surfaces carefully, leaving no residue.

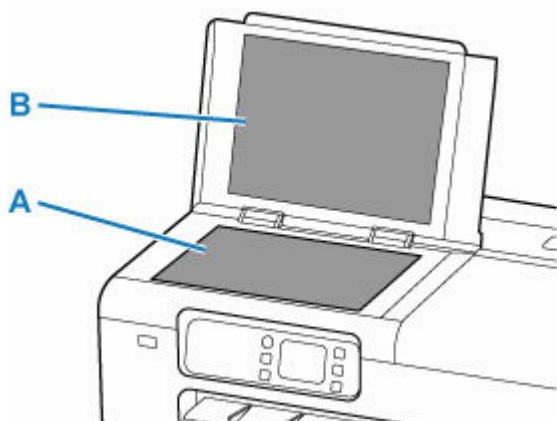

▶▶▶ Important

- The area on the back of the document cover is easily damaged, so wipe it gently.

Cleaning Paper Feed Rollers

If the paper feed roller is dirty or paper powder is attached to it, paper may not be fed properly.

In this case, clean the paper feed roller. Cleaning will wear out the paper feed roller, so perform this only when necessary.

You need to prepare: three sheets of A4 or Letter-sized plain paper

1. Select  (Setup) on the Home Screen.

➔ [Home Screen Menu Composition](#)

2. Select  **Maintenance**.

3. Select **Roller Cleaning**.

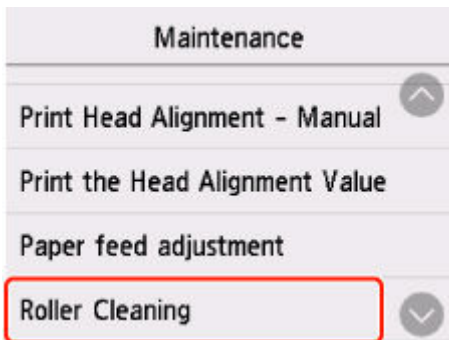

4. Select **Yes**.
5. Follow the instructions to remove any paper from the top feed.
6. Select **OK**.

The paper feed roller will rotate as it is cleaned without paper.

7. Make sure that the paper feed roller has stopped rotating, then follow the instructions to load the prepared plain paper in the top feed.

➔ [Loading Sheets in the Printer](#)

8. Select **OK**.

The printer starts cleaning. The cleaning will be complete when the paper is ejected.

9. When the completion message appears, select **OK**.

If the problem is still not resolved with the operation described above, follow the operation below.

1. Turn off the power and then unplug the power cord.

2. While rotating the paper feed rollers (A) located inside the top feed more than two laps, wipe them with a cloth tightly squeezed after moistening.

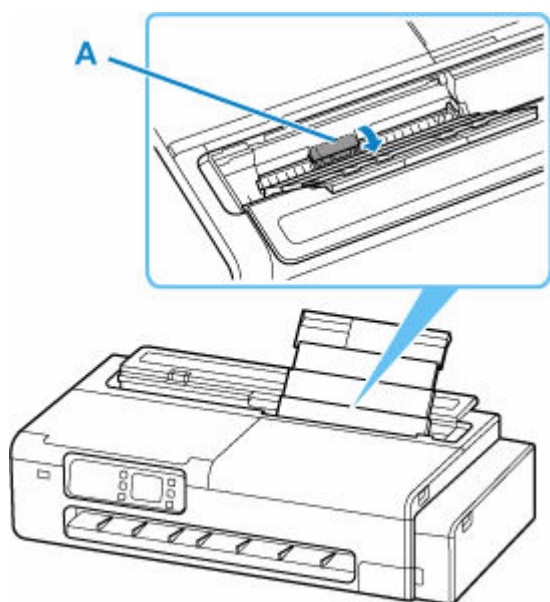

▶▶▶ Important

- Do not touch the paper feed rollers with your fingers. Paper feeding performance may be degraded.

3. Turn on the power, then clean the paper feed rollers again.

If the problem is not resolved after cleaning the paper feed roller, contact your nearest Canon service center to request a repair.

Performing Bottom Plate Cleaning

Remove stains from the inside of the printer. If the inside of the printer becomes dirty, printed paper may get dirty, so we recommend performing cleaning regularly.

You need to prepare: a sheet of A4 or letter size plain paper *

* Be sure to use a new piece of paper.



1. Select (Setup) on the Home Screen.

➔ [Home Screen Menu Composition](#)



2. Select **Maintenance**.

3. Select **Bottom Plate Cleaning**.

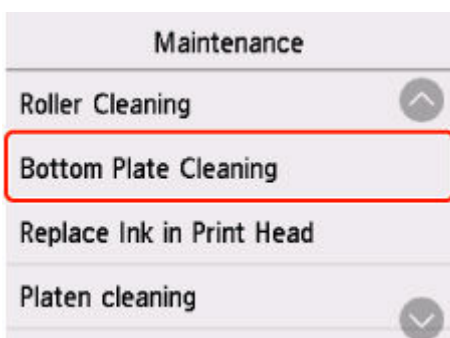

4. Select **Yes**.

5. Follow the message to remove any paper from the top feed, then select **OK**.

6. Fold the prepared plain paper in half lengthwise, unfold the paper, then select **OK**.

7. Load the plain paper horizontally in the top feed with the open side up.

➔ [Loading Sheets in the Printer](#)

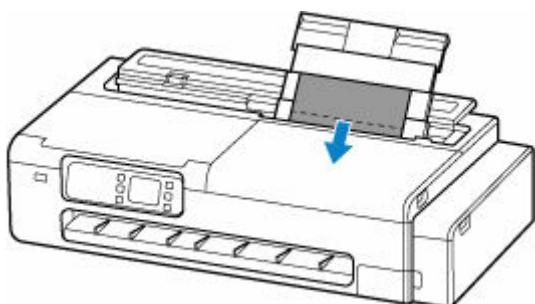

8. Select **OK**.

Bottom Plate Cleaning is performed, and paper is fed.

Check the folded parts of the ejected paper. If they are smudged with ink, perform **Bottom Plate Cleaning** again.

9. When the completion message appears, select **OK**.

▶▶▶ Note

- When performing **Bottom Plate Cleaning** again, be sure to use a new piece of paper.

If printed pages are still dirty even after cleaning again, the inside of the printer may be dirty. Clean the inside of the printer.

➔ [Cleaning Inside the Printer](#)

Performing Maintenance Functions from Your Computer (Windows)

- **Cleaning the Print Heads**
- **Printing a Nozzle Check Pattern**

Cleaning the Print Heads

The print head cleaning function allows you to clear up clogged print head nozzle. Perform print head cleaning if printing is faint or a specific color fails to print, even though there is enough ink.

The procedure for print head cleaning is as follows:



Print Head Cleaning

1. Open the [printer driver setup window](#)
2. Click **Print Head Cleaning** on the **Utility** tab
When the **Print Head Cleaning** dialog box opens, click **OK**.
3. Execute cleaning
Make sure that the printer is on and then click **OK**.
Print head cleaning starts.

»» Note

- After **Cleaning** is complete, perform **Print Nozzle Check Pattern** and check the cleaning results.

Related Topic

- ➔ [Printing a Nozzle Check Pattern](#)

Printing a Nozzle Check Pattern

The nozzle check function allows you to check whether the print head is working properly by printing a nozzle check pattern. Print the pattern if printing becomes faint, or if a specific color fails to print.

The procedure for printing a nozzle check pattern is as follows:

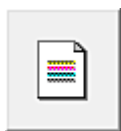

Print Nozzle Check Pattern

1. Open the [printer driver setup window](#)
2. Load paper in the printer
3. Click **Print Nozzle Check Pattern** on the **Utility** tab

The **Print Nozzle Check Pattern** dialog box opens.

4. Select the paper source

Select the paper source from the displayed dialog box.

5. Print a nozzle check pattern

Make sure that the printer is on and click **OK**.

Printing of the nozzle check pattern begins.

Click **OK** when the confirmation message appears.

6. Check the print result

Check the print results.

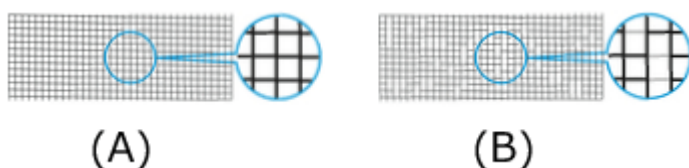

(A) As long as the horizontal lines are in line, and not missing, the nozzle is working normally.

(B) Where the horizontal lines are not in line or are missing, the color nozzle is blocked.

►► Note

- From the nozzle check pattern printing results, if it becomes patchy or there are areas that cannot be printed, use **Print Head Cleaning** to clean the print heads. Once cleaning is complete, print the nozzle check pattern again and check the results.

Related Topic

➔ [Cleaning the Print Heads](#)

Other Maintenance

- **Preparing to Transfer the Printer**
- **Reinstalling the Printer**
- **Firmware update**

Preparing to Transfer the Printer

To protect the internal parts in transit, always follow these steps before transferring the printer to a new location.

For details on installing printer after transfer, see [Reinstalling the Printer](#).

►►► Important

- You cannot take ink out of ink tanks.
- Prepare for transporting the printer with the print head attached. This allows the printer to automatically cap the print head, thus preventing it from drying.
- Do not remove the print head. Ink may leak.
- If ink stains the inside of the printer, wipe them using a soft cloth dampened with water.
 - ➔ [Cleaning Inside the Printer](#)
- Transport the printer in a plastic bag to prevent ink leakage. Prepare the plastic bag before transporting the printer.

►►► Note

- If you can move the printer in a level state using casters or something similar, you do not need to execute **Transport mode**.

Switch to Transport mode using the Operation Panel

To switch to **Transport mode** using the operation panel, follow the steps below. If you cannot switch to **Transport mode** using the operation panel due to a malfunction, see "[Repairing Your Printer](#)".

1. Remove all paper.

➔ [Removing the Roll from the Printer](#)

2. Select  (Setup) on the Home Screen.

➔ [Home Screen Menu Composition](#)

3. Select  **Maintenance**.

4. Select **Transport mode**.

5. Confirm the message, then select **Yes**.

The mode is shifted to the **Transport mode**.

When it is completed, the power is turned off automatically.

Packing Printer

1. Check that **ON** lamp is off and unplug power cord.

➔ [Checking that Power Is On](#)

▶▶▶ Important

- Do not unplug the printer while the **ON** lamp is lit or flashing. This may cause malfunction or damage to the printer, making the printer unable to print, or it may not be ready for transport, leading to ink leakage during transportation.

2. Unplug the printer cable from the computer and from the printer, then unplug the power cord from the printer.
3. Open the ink tank cover (A).

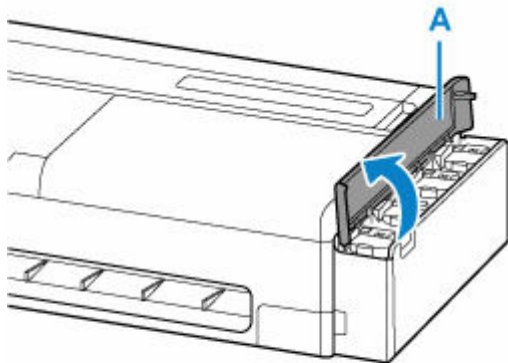

4. Open all the ink tank inner covers (B).

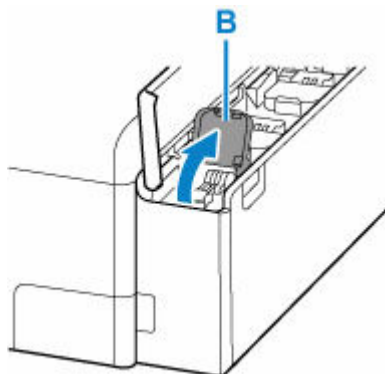

5. Make sure tank caps are closed securely.

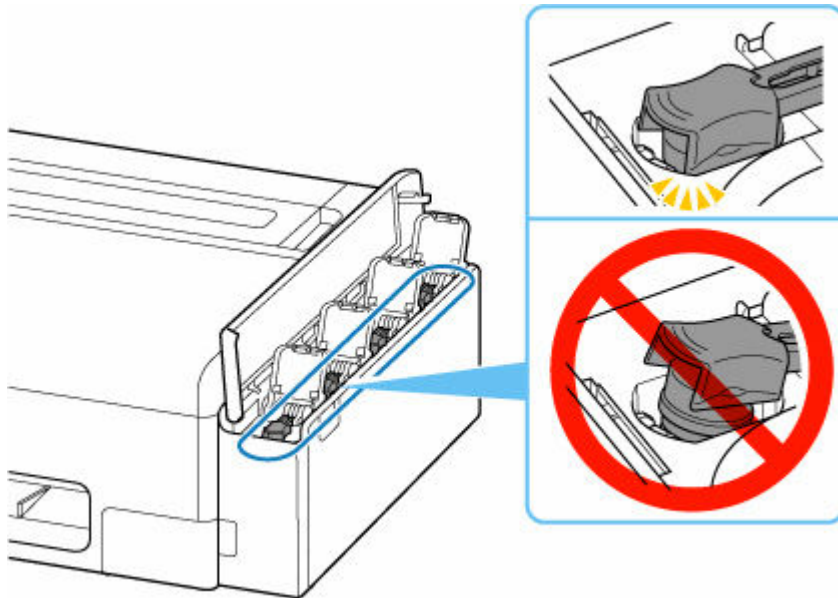

▶▶▶ Important

- Check if the tank cap is completely inserted. If the ink tank inner cover is not completely closed, insert the tank cap properly.

6. Close all the ink tank inner covers.

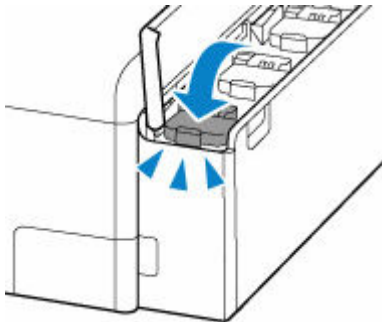

7. Close the ink tank cover.

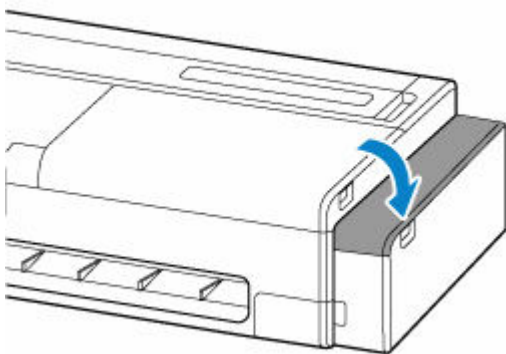

8. Open the cut sheet feed cover.

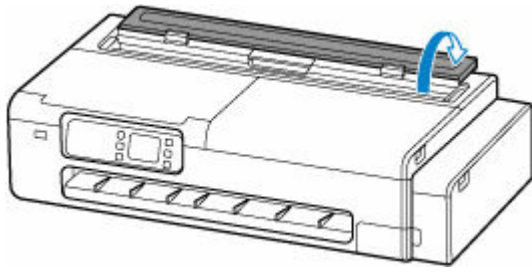

- 9.** Unlock with the lever and open the roll paper feed cover.

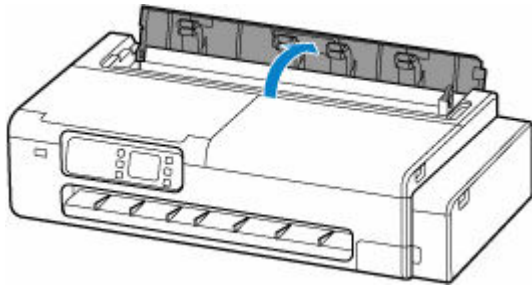

- 10.** Loosen the knurled screws (C) securing the roll holder support by turning them counterclockwise.

Depending on your printer, there may be one or two knurled screws.

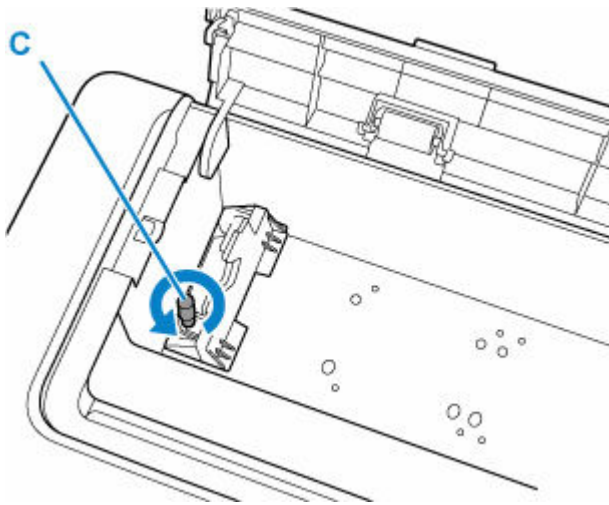

- 11.** Remove the roll holder support.

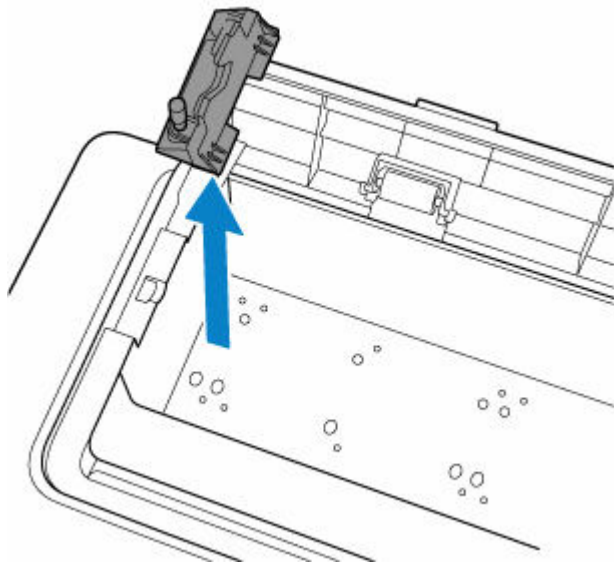

12. Use adhesive tape to secure the top feed to keep it from opening.

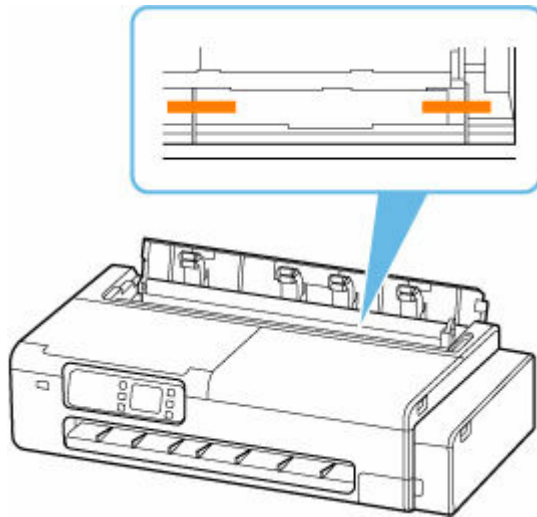

13. Close the roll paper feed cover completely.

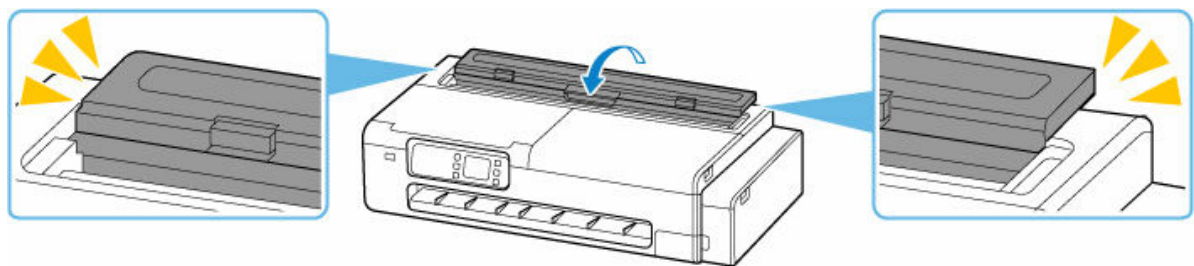

14. Close the cut sheet feed cover.

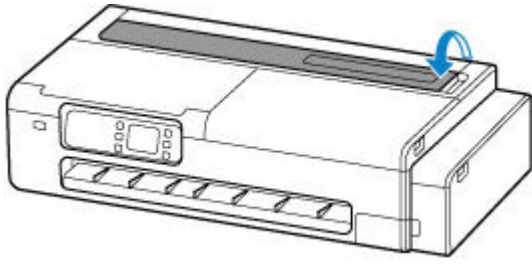

15. Use adhesive tape to secure all covers on the printer to keep them from opening.

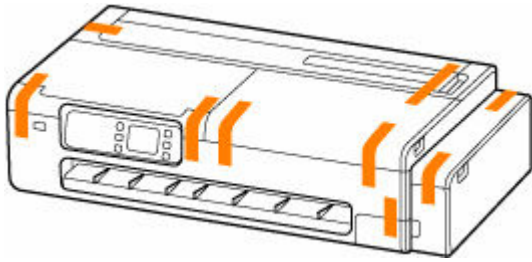

16. Remove the desktop basket or printer stand by following the installation instructions in reverse.

▶▶ Important

- When removing the desktop basket, hold down the buttons on the basket adapters and pull it out from the printer.

▶▶ Note

- Refer to the Desktop Basket Setup Guide for the desktop basket installation procedure and the Printer Stand Setup Guide for the printer stand installation procedure.

⚠ Caution

- Moving the printer requires two people. Be careful to avoid back strain and other injuries.
- When moving the printer, firmly grasp the carrying grips. The printer may be unsteady if you hold it at other positions, which poses a risk of injury from dropping the printer.

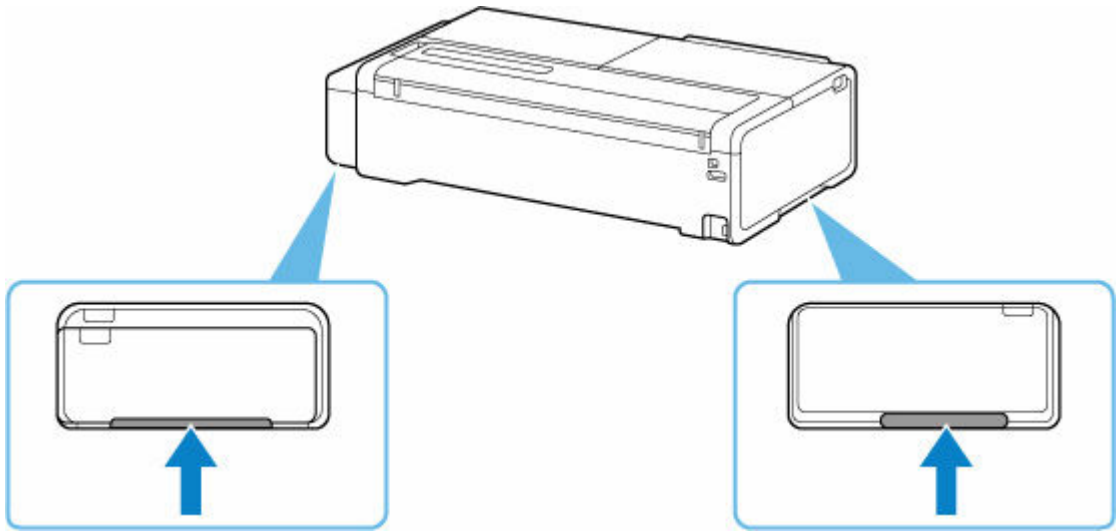

17. Pack printer in plastic bag.

Seal the mouth of the plastic bag with the tape or tie it tightly so that ink does not leak.

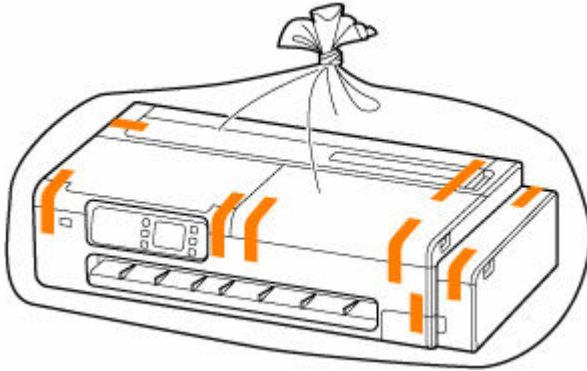

18. Pack printer in box.

Attach the protective material to the printer to pack it securely in the box.

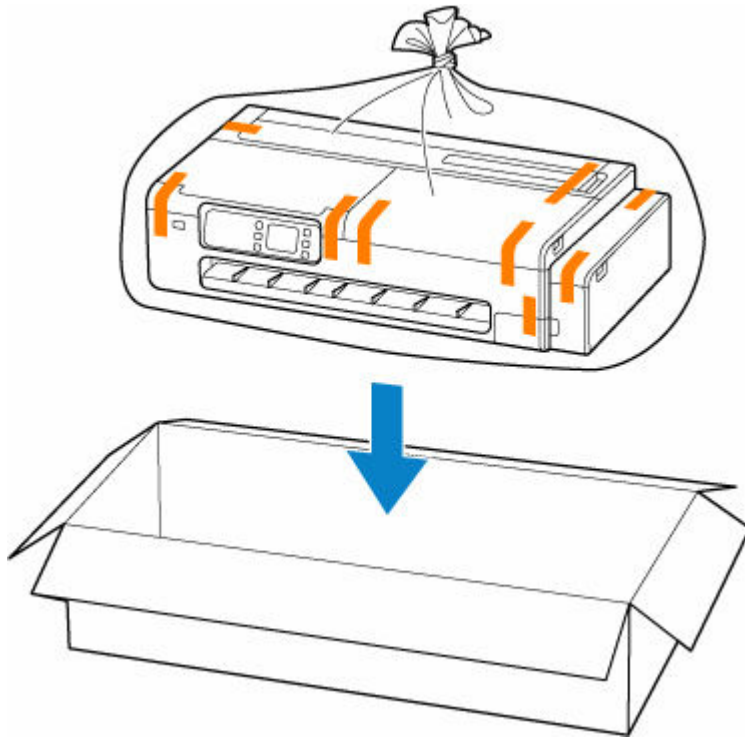

►► Important

- Pack the printer in a sturdy box so that it is placed with its bottom facing down, using sufficient protective material to ensure safe transport.
- Do not tilt the printer. Ink may leak.
- When a shipping agent is handling transport of the printer, have its box marked "THIS SIDE UP" to keep the printer with its bottom facing down. Mark also with "FRAGILE" or "HANDLE WITH CARE".
- Please handle with care and ensure the box remains flat and NOT turned upside down or on its side, as the printer may be damaged and ink in the printer may leak.
- Pack the removed roll holder and roll holder support separately from the printer.

19. Disassemble and pack the removed desktop basket or printer stand by following the installation instructions in reverse.

►► Important

- Pack the removed desktop basket or printer stand separately from the printer.

Reinstalling the Printer

The basic workflow for reinstalling the printer is as follows.

Assemble the stand (Option)

1. If you want to use the printer stand, assemble the printer stand.

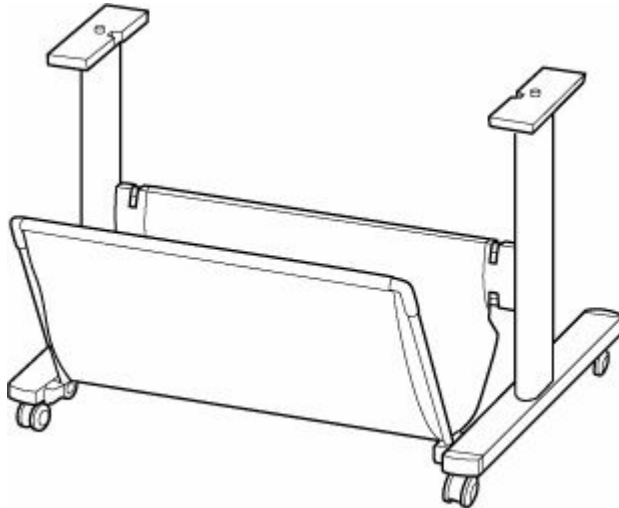

▶▶ Note

- For instructions on assembling and installing the printer stand, see the Printer Stand Setup Guide.

Install the printer

1. Remove the packed printer from the box and bag.

⚠ Caution

- Moving the printer requires two people. Be careful to avoid back strain and other injuries.
- When moving the printer, firmly grasp the carrying grips. The printer may be unsteady if you hold it at other positions, which poses a risk of injury from dropping the printer.

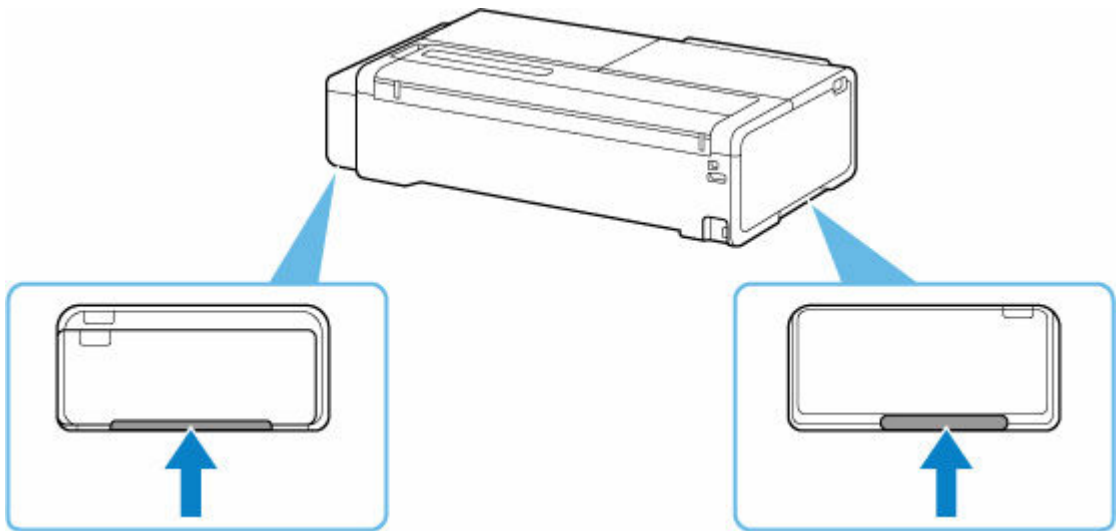

2. When using the printer stand, attach the printer to the assembled stand.

3. When using a desktop basket, attach the desktop basket to the printer.

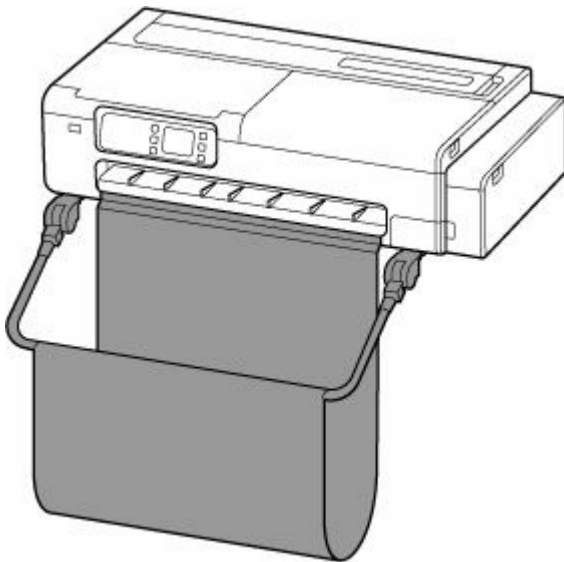

►► Important

- The printer stand and desktop basket cannot be installed at the same time.

►► Note

- For instructions on installing the desktop basket, see the Desktop Basket Setup Guide.

4. Install the roll holder support.

Depending on your printer, there may be one or two knurled screws.

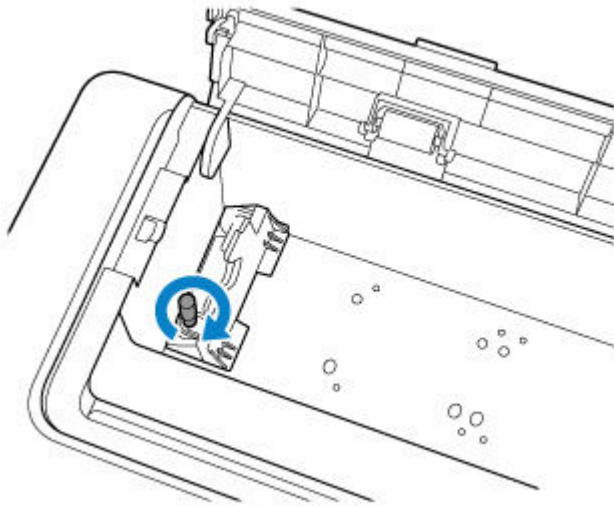

5. Plug the power cord into the power cord connector on the back of the printer.

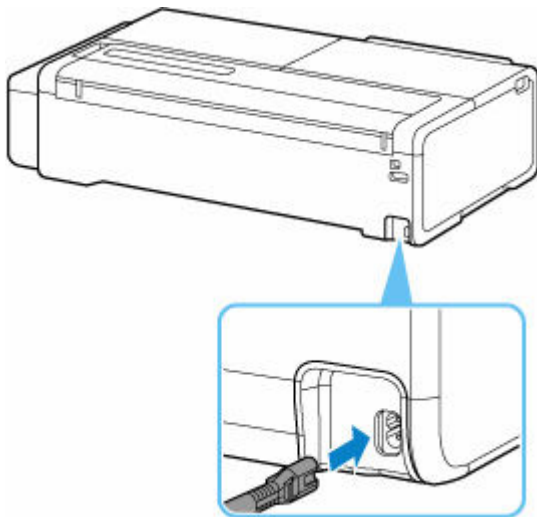

6. Plug the power plug into an outlet.

7. Press **ON** button to turn on printer.

➔ [Turning on the printer](#)

8. Load paper in the printer.

➔ [Loading Sheets in the Printer](#)

➔ [Loading Rolls in the Printer](#)

9. Install the software.

Note that the driver installation procedure varies depending on the type of connection.

➔ [Installing the Printer Driver](#) (Windows)

➔ [Installing the Printer Driver](#) (macOS)

»» Important

- When the printer is connected to a network (via TCP/IP), the printer's IP address may be changed if you reinstall the printer.

In this case, be sure to reconfigure the printer's IP address.

Firmware update

▶▶▶ Important

- When you use this function, make sure the printer is connected to the Internet.
- The administrator password is required to change settings if it is enabled for changing settings using the operation panel.

Using Operation Panel



1. Select **Setup** on the HOME screen.

➔ [Home Screen Menu Composition](#)

2. Select **Printer settings**.

3. Select **Firmware update**.

If an administrator password is set, enter the password.

4. Select **Install update**.

5. Select **Yes**.

6. Check message and select **Start update**.

Using Remote UI

1. Start up Remote UI.

➔ [Start up Remote UI](#)

2. Select **Firmware update**.

3. Select **Install update**.

4. Check message and select **Update**.

▶▶▶ Note

- If the firmware update is not complete, check the following and take an appropriate action.
 - Check the network settings such as a wireless router.

- If **Cannot connect to the server.** is displayed on the touch screen, select **OK** and try again after a while.

Frequently Asked Questions

Problems with the Printing Quality



Unevenness, Banding, Faint

- ➔ [Printing is faint](#)
 - ➔ [Banding in different colors occurs](#)
 - ➔ [Colors in printed images are uneven](#)
 - ➔ [Image edges are blurred or white banding occurs](#)
-

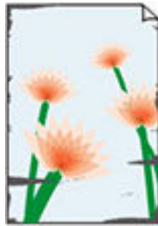

dirt

- ➔ [Paper rubs against the Print Head](#)
 - ➔ [The edges of the paper are dirty](#)
 - ➔ [The surface of the paper is dirty](#)
 - ➔ [The back side of the paper is dirty](#)
-



colors are inaccurate

- ➔ [Printed colors are inaccurate](#)
 - ➔ [Documents are printed in monochrome](#)
-



Line

- ➔ [Line thickness is not uniform](#)
- ➔ [Lines or colors are misaligned](#)

Others

- ➔ [The length of the printed image in the paper ejection direction is not accurate](#)
- ➔ [Images are printed crooked](#)
- ➔ [Margins are wide](#)

General FAQ

- ➔ [Printer Does Not Print](#)
- ➔ [Cannot Print or Connect](#)
- ➔ [The printer does not respond even if print jobs are sent](#)
- ➔ [Printing stops and an error message is displayed](#)
- ➔ [Failed to Printer Driver Installation \(Windows\)](#)
- ➔ [Removing Printer Software](#)
- ➔ [Repairing Your Printer](#)

Search by Category

Cannot Configure Network Settings

- ➔ [Message Appears on Computer During Setup](#)
- ➔ [Cannot Proceed beyond Printer Connection Screen/Connect Cable Screen](#)
- ➔ ["Failed to connect to the wireless router." Appears](#)
- ➔ [Printer Cannot Be Used After Replacing Wireless Router or Changed Router Settings](#)
- ➔ [Error Occurs During Wi-Fi Setup](#)
- ➔ [Taking Time to Setup Process \(Windows\)](#)

Cannot Find Printer on Network

- ➔ [Cannot Connect Printer to Network](#)
- ➔ [Cannot Find Printer During Setup](#)
- ➔ [Cannot Find Printer while Using Wi-Fi](#)
- ➔ [Cannot Find Printer while Using Wired LAN](#)
- ➔ [Searching Printer by IP Address or Host Name During Setup](#)

Cannot Print over Network

- ➔ [Cannot Print over TCP/IP Network](#)
- ➔ [Cannot Print over Bonjour networks](#)

- ➔ [Cannot Print Using AirPrint](#)

Network Connection Problems

- ➔ [Network Settings and Common Problems](#)
- ➔ [Cannot Connect to the Printer](#)
- ➔ [Network Key \(Password\) Unknown](#)
- ➔ [Forgot Administrator Password of Printer](#)
- ➔ [Checking Network Information](#)
- ➔ [Restoring to Factory Defaults](#)
- ➔ [Cannot Access to Internet on Wi-Fi from Communication Device](#)

Printer Problems

- ➔ [Printer Does Not Turn On](#)
- ➔ [USB Connection Problems](#)
- ➔ [Cannot Communicate with Printer via USB](#)
- ➔ [Touch Screen Is Off](#)
- ➔ [Messages advising to check the maintenance cartridge are not cleared](#)
- ➔ [If the Printer Makes a Strange Sound](#)

Printing Problems

- ➔ [Copying/Printing Stops](#)
- ➔ [Printer Prints Slowly](#)

Paper is not Fed or Ejected Properly

- ➔ [Remove Jammed Roll Paper](#)
- ➔ [Remove a Jammed Sheet](#)
- ➔ [Remove Jammed Paper \(Paper Feed Slot\)](#)
- ➔ [Roll paper cannot be inserted into the Paper Feed Slot](#)
- ➔ [Printer Does Not Pick up or Feed the Paper/"No Paper" Error](#)
- ➔ [Roll Paper Remains/Lacks under Quantity Management](#)
- ➔ [The printer ejects blank, unprinted paper](#)
- ➔ [When printing on roll paper, the printed surface becomes scratched](#)

Paper Cutting Problems

- ➔ [Paper is not cut straight](#)
- ➔ [Cutter Blade Does Not Work While Cutting Is in Progress](#)
- ➔ [I want to know how to configure roll cutting](#)
- ➔ [I want to configure so that the roll is cut automatically after waiting for the ink to dry](#)

Paper Setting Problems

- ➔ [Cannot detect tracing paper size](#)
- ➔ [I want to know the paper types that can be used in this printer](#)
- ➔ [Media Type Selection does not Match Loaded Media Type](#)
- ➔ [The paper type that I want to print is not displayed on the Touch Screen](#)

Ink-related Problems

- ➔ [Ink Does Not Come Out](#)
- ➔ [Printer consumes a lot of ink](#)
- ➔ [Ink Level Detection](#)

About Print Settings

- ➔ [How do I print without borders](#)
- ➔ [I want to easily create vertical or horizontal banners](#)
- ➔ [Can I perform duplex printing](#)
- ➔ [I want to perform enlargement printing](#)

Cannot Scan

- ➔ [Scanning Problems \(Windows\)](#)
- ➔ Scanning Problems (macOS)



Printer Does Not Print



Check 1 Make sure printer is turned on.

If not, make sure the printer is securely plugged in and press **ON** button to turn on.

The **ON** lamp flashes while the printer is initializing. Wait until the **ON** lamp stops flashing and remains lit.

▶▶▶ Note

- If you are printing large data such as photos or other graphics, printing may take longer to start. The **ON** lamp flashes while the computer is processing data and sending it to the printer. Wait until printing starts.

Check 2 Make sure printer is properly connected to computer.

If you are using a USB cable, make sure it is securely connected to both the printer and the computer. When the USB cable is securely plugged in, check the following:

- If you are using a relay device such as a USB hub, disconnect it, connect the printer directly to the computer, and retry the printing. If printing starts normally, there is a problem with the relay device. Contact the vendor of the relay device.
- There could also be a problem with the USB cable. Replace the USB cable and retry the printing.

If you use the printer with a network connection, make sure the printer is correctly set up for network use.

- ➔ [Cannot Find Printer while Using Wi-Fi](#)
- ➔ [Cannot Find Printer while Using Wired LAN](#)

▶▶▶ Note

- Wi-Fi Connection Assistant allows you to diagnose and repair the network status.
Select the link below to download Wi-Fi Connection Assistant and install it.
 - ➔ [Checking Printer Connection Status Using Wi-Fi Connection Assistant](#)

Check 3 Make sure paper settings match information set for the printer

If the paper settings do not match the information set for the printer, an error message appears on the touch screen. Follow the instructions on the touch screen to solve the problem.

Check 4 If printing from a computer, delete unnecessary print jobs.

- **For Windows:**
 - ➔ [Deleting the Undesired Print Job](#)
- **For macOS:**
 - ➔ [Deleting the Undesired Print Job](#)

Check 5 Is your printer's printer driver selected when printing?

The printer will not print properly if you are using a printer driver for a different printer.

- **For Windows:**

Make sure "Canon XXX" (where "XXX" is your printer's name) is selected in the Print dialog box.

▶▶▶ Note

- If multiple printers are registered to your computer, set your printer as default printer to make the one selected by default.

For Windows 10:

If you have set the default printer, additional settings are required to stop Windows 10 from changing the default printer.

Select **Settings > Devices > Printers & scanners** and uncheck **Let Windows manage my default printer**.

- **For macOS:**

Make sure your printer's name is selected in **Printer** in the Print dialog.

▶▶▶ Note

- If multiple printers are registered to your computer, select **Set as Default Printer** from **System Preferences > Printers & Scanners** for a printer to make the one selected by default.

Check 6 If printing from your computer, restart the computer.

Restart the computer and try printing again.



Cannot Print or Connect



If you need to redo printer setup:

Redo printer setup if one of the conditions below applies.

- If you have replaced a computer or wireless router
- If you have changed wireless router settings
- If you have changed the printer connection method (Wi-Fi / wired LAN / USB)

See the Setup Guide for details on the setup procedure.

If you have forgotten the administrator password specified for the printer:

➔ [Forgot Administrator Password of Printer](#)

If none of the above applies:

See [Cannot Connect to the Printer](#).

If this does not solve the problem, contact your nearest Canon service center to request a repair.



The printer does not respond even if print jobs are sent



Check Is LAN connection disabled?

Set **Enable/disable Wired LAN**, **Enable/disable Wi-Fi**, or **Enable/disable Wireless Direct** on the touch screen menu to **Enable**.

▶▶▶ Note

- Wired LAN and Wi-Fi or wired LAN and wireless direct cannot be used simultaneously.



Printing stops and an error message is displayed



If the action indicated in the error message does not solve the problem, the roll paper may be stuck and not able to be advanced.

Check 1 Is the loaded roll paper touching printer parts, etc.?

If the loaded roll paper is touching printer parts, load the roll paper again.

➔ [Removing the Roll from the Printer](#)

Check 2 Is the roll paper proper to use?

Check the outer diameter and paper thickness of the roll paper that can be used with your printer.

➔ [Paper Sizes](#)



Failed to Printer Driver Installation (Windows)



- If you cannot get past the Printer Connection screen:

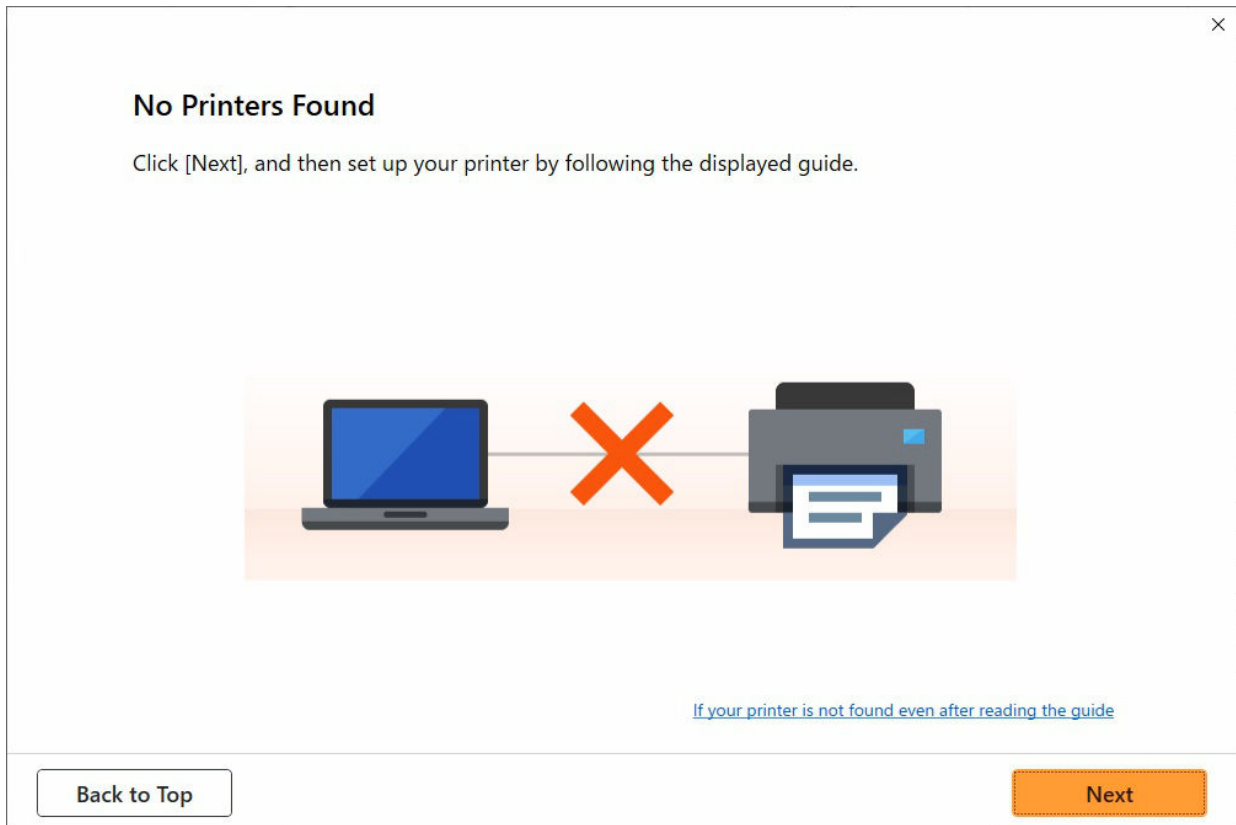

- ➔ [Cannot Proceed beyond Printer Connection Screen/Connect Cable Screen](#)

- **Other cases:**

Reinstall the printer driver.

If the printer driver was not installed correctly, uninstall the printer driver, restart your computer, and then reinstall the printer driver.

- ➔ [Deleting the Unnecessary Printer Driver](#)

Reinstall the printer driver from the Canon website.

▶▶▶ Note

- If the installer was stopped due to a Windows error, Windows operation may be unstable, and you may not be able to install the drivers. Restart your computer and then reinstall the drivers.



Removing Printer Software



Follow the steps below to remove utility software installed on the computer.

▶▶▶ Important

- You must log in as an administrator or have administrator permissions.

▶▶▶ Note

- See the pages below for how to remove printer drivers.
 - ➔ [Deleting the Unnecessary Printer Driver](#) (Windows)
 - ➔ Delete the Unnecessary Canon IJ Printer from the Printer List (macOS)

Removing the Wi-Fi Connection Assistant (Windows)

Follow the steps below to remove the Wi-Fi Connection Assistant.

- Windows 10

1. Click **start**, select **Windows System**, and then select **Control Panel**.
2. Under **Programs**, select **Programs and Features**, select Wi-Fi Connection Assistant from the list of programs, and then click **Uninstall**.

- Windows 8.1

1. Use the **Settings** charm on the desktop to open the **Control Panel**.
2. Under **Programs**, select **Programs and Features**, select Wi-Fi Connection Assistant from the list of programs, and then click the **Uninstall** button.

- Windows 7

1. Select **Control Panel** from the **start** menu.
2. Select **Uninstall a program**.
3. Select Wi-Fi Connection Assistant, and then click the **Uninstall** button.

▶▶▶ Note

- If the **User Account Control** dialog box is displayed, click **Yes**.

Removing the Wi-Fi Connection Assistant (macOS)

Follow the steps below to remove the Wi-Fi Connection Assistant.

1. Select **Applications** from **Go** menu of Finder, double-click **Canon Utilities > Wi-Fi Connection Assistant**, and then drag **Canon Wi-Fi Connection Assistant** icon into **Trash**.
2. Restart computer.
Empty the **Trash** and restart your computer.

▶▶ Note

- To reinstall Wi-Fi Connection Assistant, uninstall Wi-Fi Connection Assistant and install it again from the Canon website.

Repairing Your Printer

If the power does not turn on or you cannot run the transport mode from the operation panel, perform the following steps.

►► Important

- You cannot take ink out of ink tanks.
- Make sure the tank caps of ink tanks are closed securely. If the tank caps are open, close the tank caps properly.
- Press the **ON** button to turn off the printer with the print heads installed. The printer protects the print heads by covering them automatically to prevent them from being dried.
- Do not remove the print heads. Ink may leak.
- If the inside of the printer becomes dirty, clean with a soft cloth that gets wet with water and squeezed firmly.
- When transporting the printer, pack the printer in a plastic bag so that ink does not leak.
- Pack the printer in a sturdy box so that it is placed with its bottom facing down, using sufficient protective material to ensure safe transport.
- Do not tilt the printer; otherwise, ink may leak.
- When a shipping agent is handling transport of the printer, have its box marked "THIS SIDE UP" to keep the printer with its bottom facing down. Mark also with "FRAGILE" or "HANDLE WITH CARE".

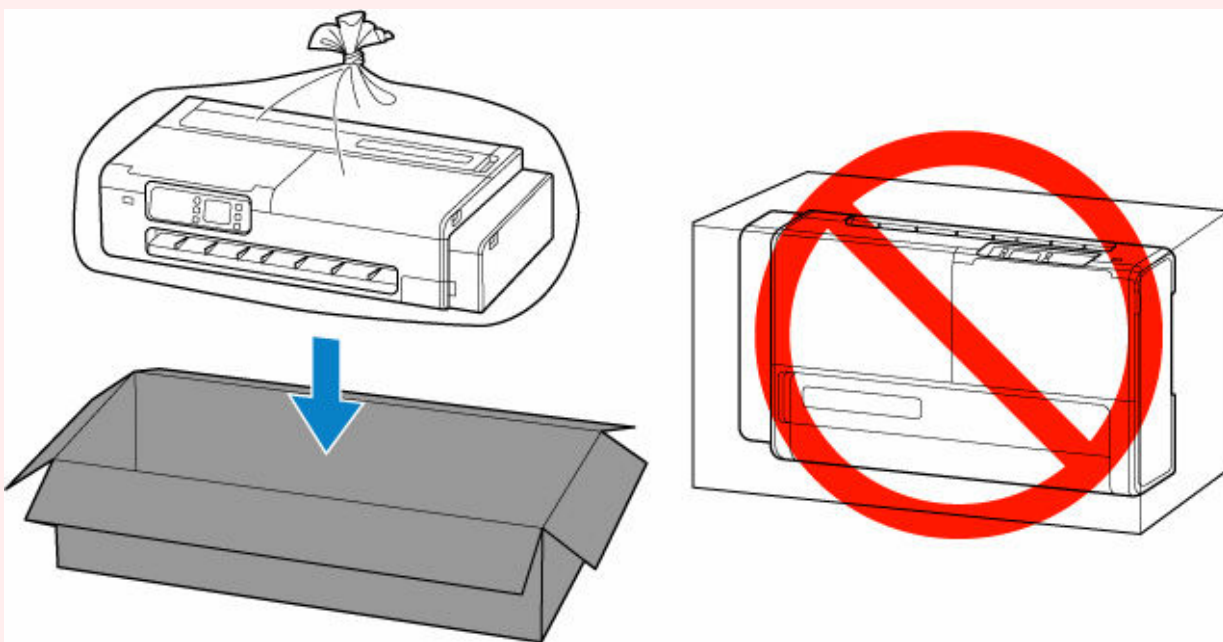

- Please handle with care and ensure the box remains flat and NOT turned upside down or on its side, as the printer may be damaged and ink in the printer may leak.

1. If the power is on, press the **ON** button to turn off the printer.

➔ [Turning off the printer](#)

2. Remove all paper.
3. Open the access cover on the right side of the printer.

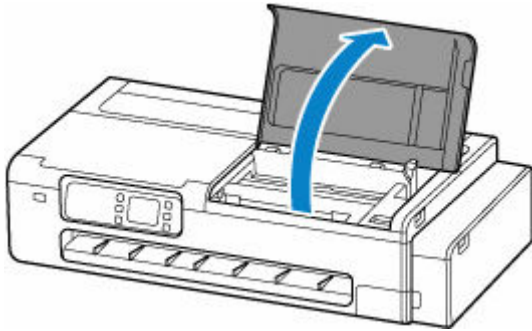

4. Close ink valve.

Close the ink valve by tilting the ink valve lever tightly to the left.

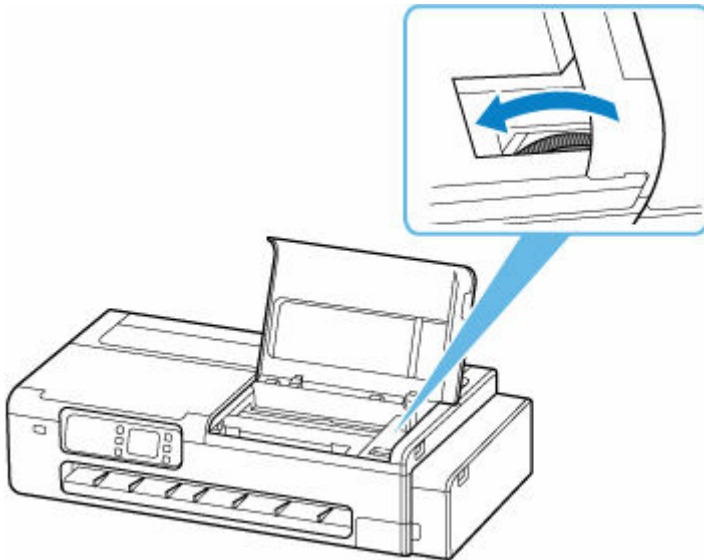

►► Important

- If you pack the printer without closing the ink valve, ink may leak out. Be sure to close the ink valve before packing the printer.
- If the ink valve lever is dirty, wipe the lever clean before closing the valve.

►► Note

- If the ink valve lever is already tilted to the left and the ink valve is closed, leave it in place.

5. Close the access cover on the right side of the printer.

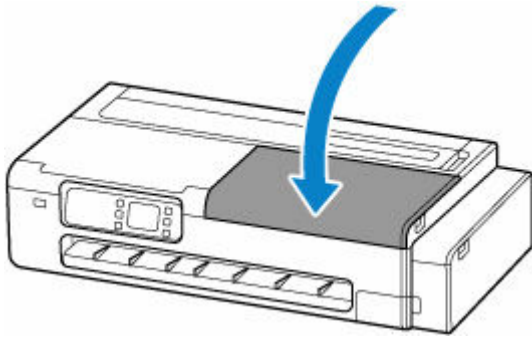

6. Pack the printer.

➔ [Packing Printer](#)

»» Important

- Remove the roll holder, roll holder support, desktop basket, and printer stand from the printer. Contact the customer service center in your country or region for information on how to handle these parts when sending the printer unit for repair.

Problems with the Printing Quality

- **Printing is faint**
- **Banding in different colors occurs**
- **Colors in printed images are uneven**
- **Image edges are blurred or white banding occurs**
- **Paper rubs against the Print Head**
- **The edges of the paper are dirty**
- **The surface of the paper is dirty**
- **The back side of the paper is dirty**
- **Printed colors are inaccurate**
- **Documents are printed in monochrome**
- **Line thickness is not uniform**
- **Lines or colors are misaligned**
- **The length of the printed image in the paper ejection direction is not accurate**
- **Images are printed crooked**
- **Margins are wide**



Printing is faint

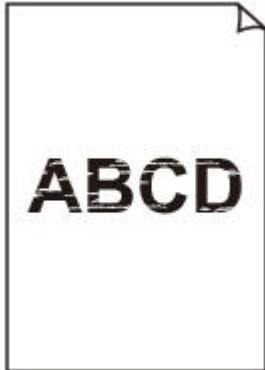

Check 1 Is the reverse side of the paper being used for printing?

Print on the printing surface.

Check 2 Is the Print head nozzle blocked?

Print a test pattern to check the nozzles and see if they are clogged.

➔ [Checking for Nozzle Clogging](#)

Check 3 Are paper scraps stuck in the printer?

Remove paper scraps left inside the printer.

➔ [Remove Jammed Roll Paper](#)

➔ [Remove a Jammed Sheet](#)

Check 4 Was the paper cut before the ink dried?

In the touch screen menu, select **Paper-related settings > Advanced paper settings**, and increase time in **Pause between scans** or **Pause between pages**.

➔ [Specifying the Ink Drying Time](#)

Check 5 When printing photos and posters, are the **Print target** settings set correctly?

Do one of the following.

- In the printer driver, change the setting to **Photo (Color)** or **Poster** in **Print Target**.

➔ [Printing by setting the Print target](#)

- In the touch screen menu, select **Printer settings > Print settings > Default print settings > Print quality settings > Print target**, and change the setting to **Photo**. (This is only available when the printer driver's **Media Type** is set to **Auto (Use Printer Settings)**).

➔ [Menu Structure](#)

Check 6 Is the printer driver **Print Quality** set to a low quality setting?

Follow the steps below to set **Print Quality** to higher quality settings, and then print.

- Windows

Change the **Print Quality** settings in the printer driver **Advanced Settings**.

➔ [Changing the Print Quality and Correcting Image Data](#) (Windows)

- macOS

Change the **Print Quality** in the printer driver **Quality & Media** settings.

➔ [Changing the Print Quality and Correcting Image Data](#) (macOS)

Check 7 Does the paper used for printing create a lot of cutting dust?

In the touch screen menu, set **Cut-dust reduction** in **Advanced paper settings** to **ON**.

➔ [Reducing Dust from Cutting Rolls](#)



Banding in different colors occurs



Check 1 Make sure that the Print head nozzle is not blocked

Print a test pattern to check the nozzles and see if they are clogged.

➔ [Checking for Nozzle Clogging](#)

Check 2 Is the media type specified in the printer driver the same as the media type loaded in the printer?

When printing with the media type specified in the printer driver, load the specified media type in the printer.

➔ [Loading Rolls in the Printer](#)

➔ [Loading Sheets in the Printer](#)

When printing with the media type loaded in the printer, specify the same media type in the printer driver.

1. To stop printing, press the **Stop** button.
2. Change the type of paper in the printer driver and try printing again.

▶▶▶ Note

- When **Auto (Use Printer Settings)** is selected for the media type, printing is performed with the media type loaded in the printer.
- Click **Get Information** to reflect the paper information set in the printer to the printer driver.

➔ [Printing with Easy Setup](#)

Check 3 Does the paper loaded on the printer match the media type selected on the touch screen?

Select the correct media type in the touch screen menu when loading paper in the printer.

- ➔ [Loading Rolls in the Printer](#)
- ➔ [Loading Sheets in the Printer](#)

Check 4 Has the paper feed rate been calibrated properly?

Adjust the feed amount.

- ➔ [Automatically Adjusting Different Colored Horizontal Streaks](#)
- ➔ [Adjusting Line Length](#)

Check 5 When printing photos and posters, are the **Print target** settings set correctly?

Do one of the following.

- In the printer driver, change the setting to **Photo (Color)** or **Poster** in **Print Target**.
 - ➔ [Printing by setting the Print target](#)
- In the touch screen menu, select **Printer settings** > **Print settings** > **Default print settings** > **Print quality settings** > **Print target**, and change the setting to **Photo**. (This is only available when the printer driver's **Media Type** is set to **Auto (Use Printer Settings)**).
 - ➔ [Menu Structure](#)

Check 6 Low **Print Quality** setting causing lines in the printing

Follow the steps below to set **Print Quality** to the highest quality setting, and then print.

- Windows
Change the **Print Quality** settings in the printer driver **Advanced Settings**.
 - ➔ [Changing the Print Quality and Correcting Image Data](#) (Windows)
- macOS
Change the **Print Quality** in the printer driver **Quality & Media** settings.
 - ➔ [Changing the Print Quality and Correcting Image Data](#) (macOS)

Check 7 Is **Set priority** in the touch screen menu set to **Prioritize length accuracy**?

Setting **Set priority** to **Prioritize print quality** and adjusting the feed amount can help.

- ➔ [Automatically Adjusting Different Colored Horizontal Streaks](#)
- ➔ [Adjusting Line Length](#)

Check 8 Check if the Print head is in the right position

Adjust the Print head position.

- ➔ [Automatic Adjustment to Straighten Lines and Colors](#)

Check 9 Print job may have been interrupted while receiving, and therefore not printed at a fast frame rate

Exit other applications and cancel other print jobs.



Colors in printed images are uneven



Check 1 Does the paper loaded on the printer match the media type selected in the printer driver?

When printing with the media type specified in the printer driver, load the specified media type in the printer.

- ➔ [Loading Rolls in the Printer](#)
- ➔ [Loading Sheets in the Printer](#)

When printing with the media type specified in the printer driver, load the specified media type in the printer.

1. To stop printing, press the **Stop** button.
2. Change the paper type in the printer driver and try printing again.

▶▶▶ Note

- When **Auto (Use Printer Settings)** is selected for the media type, printing is performed with the media type loaded in the printer.
- Click **Get Information** to reflect the paper information set in the printer to the printer driver.
 - ➔ [Printing with Easy Setup](#)

Check 2 When loading paper in the printer, is the media loaded the same as the media type selected on the touch screen?

Select the correct media type in the touch screen menu when loading paper in the printer.

- ➔ [Loading Rolls in the Printer](#)
- ➔ [Loading Sheets in the Printer](#)

Check 3 Is the Print head position adjusted correctly?

Adjust the Print head position.

➔ [Automatic Adjustment to Straighten Lines and Colors](#)

Check 4 Is the feed amount adjusted correctly?

Adjust feed amount.

- ➔ [Automatically Adjusting Different Colored Horizontal Streaks](#)
- ➔ [Adjusting Line Length](#)

Check 5 When printing photos and posters, are the **Print target** settings set correctly?

Do one of the following.

- In the printer driver, change the setting to **Photo (Color)** or **Poster** in **Print Target**.
 - ➔ [Printing by setting the Print target](#)
- In the touch screen menu, select **Printer settings > Print settings > Default print settings > Print quality settings > Print target**, and change the setting to **Photo**. (This is only available when the printer driver's **Media Type** is set to **Auto (Use Printer Settings)**).
 - ➔ [Menu Structure](#)

Check 6 Colors in printed images may be uneven if the **Print Quality** setting is too low

If using Windows, select **Advanced Settings** from the **Main** tab of the printer driver, and then select a higher **Print Quality** setting.

If using macOS, select **Quality & Media** in the printer driver, and then select a higher **Print Quality** setting.

- ➔ [Changing the Print Quality and Correcting Image Data](#) (Windows)
- ➔ [Changing the Print Quality and Correcting Image Data](#) (macOS)

Check 7 Are the Print Head nozzles clogged?

Check for nozzle clogging.

- ➔ [Checking for Nozzle Clogging](#)

Check 8 Colors in printed images may be uneven on the boundary between shades if there are dark and light areas in an image

Prints on the same page while switching between Bidirectional printing and Unidirectional printing. Therefore, color unevenness may occur when switching. Using the unidirectional printing function may reduce color unevenness in this situation.

Follow the steps below for unidirectional printing.

- Windows
 - Open **Paper Detailed Settings** from the **Main** tab of the printer driver, and then select **Unidirectional Printing**.
 - ➔ [Description of the Main sheet screen](#)
- macOS
 - Open **Advanced Paper Settings** in the printer driver, and then select **Unidirectional Printing**.
 - ➔ [Advanced Paper Settings](#)

»» Important

- If any of the following conditions are met in the printer driver settings, the unidirectional printing function setting will be disabled.
 - The **Banner Printing** check box is checked.
 - The paper length exceeds 78.7 inches (2000.0 mm).

Check 9 Does this paper curl easily?

Colors in printed images may be uneven at the leading edge of paper that curls easily. Set a margin of at least 0.8 inches (20 mm) at the front edge of the paper.

➔ [Making Margin Settings for Rolls](#)

Check 10 Color may be uneven if printing materials were stacked while drying

To avoid uneven colors, we recommend drying each sheet separately.

Check 11 Is Ink drying target area for **Pause between scans** in the touch screen menu set to **Leading edge**?

If the **Ink drying target area** for **Pause between scans** is set to **Leading edge**, color may be uneven approximately 4.3 to 6.3 inches (110 to 160 mm) from the front edge of the paper. (The position depends on the **Print Quality** settings)



On the HOME screen of the touch screen, select  (**Setup**) > **Printer settings** > **Paper-related settings** > **Advanced paper settings** > **Pause between scans** > **Ink drying target area** and set to **Overall**.

However, note that printing will now take longer.

➔ [Specifying the Ink Drying Time](#)



Image edges are blurred or white banding occurs



Check 1 Check if the Print head is in the right position.

For detailed printing of small text or fine lines on glossy or semi-gloss photo paper etc., adjust the position of the Print head.

➔ [Automatic Adjustment to Straighten Lines and Colors](#)

Check 2 Is the media type specified in the printer driver the same as the media type loaded in the printer?

When printing with the media type specified in the printer driver, load the specified media type in the printer.

- ➔ [Loading Rolls in the Printer](#)
- ➔ [Loading Sheets in the Printer](#)

When printing with the media type specified in the printer driver, load the specified media type in the printer.

1. To stop printing, press the **Stop** button.
2. Change the paper type in the printer driver and try printing again.

▶▶▶ Note

- When **Auto (Use Printer Settings)** is selected for the media type, printing is performed with the media type loaded in the printer.
- Click **Get Information** to reflect the paper information set in the printer to the printer driver.
 - ➔ [Printing with Easy Setup](#)

Check 3 When loading paper in the printer, is the media loaded the same as the media type selected on the touch screen?

Select the correct media type in the touch screen menu when loading paper in the printer.

- ➔ [Loading Rolls in the Printer](#)
- ➔ [Loading Sheets in the Printer](#)

Check 4 Are the Print Head nozzles clogged?

Perform print head cleaning.

- ➔ [Cleaning the Print Head](#)



Paper rubs against the Print Head



Check 1 Is the media type specified in the printer driver the same as the media type loaded in the printer?

When printing with the media type specified in the printer driver, load the specified media type in the printer.

- ➔ [Loading Rolls in the Printer](#)
- ➔ [Loading Sheets in the Printer](#)

When printing with the media type loaded in the printer, specify the same media type in the printer driver.

1. To stop printing, press the **Stop** button.
2. Change the paper type in the printer driver and try printing again.

▶▶▶ Note

- When **Auto (Use Printer Settings)** is selected for the media type, printing is performed with the media type loaded in the printer.
- Click **Get Information** to reflect the paper information set in the printer to the printer driver.
 - ➔ [Printing with Easy Setup](#)

Check 2 When loading paper in the printer, is the media loaded the same as the media type selected on the touch screen?

Select the correct media type in the touch screen menu when loading paper in the printer.

- ➔ [Loading Rolls in the Printer](#)
- ➔ [Loading Sheets in the Printer](#)

Check 3 Is the paper loaded properly?

If not loaded properly, paper can buckle and rub against the Print head.

Reload the paper.

- ➔ [Loading Rolls in the Printer](#)
- ➔ [Loading Sheets in the Printer](#)

Check 4 Are the margins of the rolls narrow?

Narrow margins can cause the leading edge of the paper to curl easily, and the raised paper may rub against the head after the ink has landed on it. Make the margins wider.

- ➔ [Making Margin Settings for Rolls](#)

Check 5 If you are using plain paper, changing the settings from the printer driver may improve the print results.

- For the target setting mode
Select **Poster/Photo** in **Print Target**.
➔ [Printing by setting the Print target](#)
- For the advanced setting mode
Select **Image** in **Print Priority**.
➔ [Printing using the Preferences mode](#)

Check 6 If you are using rolls, are you using the recommended paper and recommended environment?

Using rolls or environments other than those recommended, may result in increased curl and rubbing of the print head. Use the recommended paper and recommended environment.

- ➔ [List of paper settings \(roll paper\)](#)

Check 7 Set the setting to prevent paper rubbing.

Adjusting the setting to prevent paper abrasion will widen the clearance between the print head and the paper. If you notice abrasion even with the media type set correctly to match the paper, set the printer to prevent paper abrasion using the operation panel or the computer.

This may reduce the print speed.

* Once you have finished printing, undo this setting. Otherwise, it will apply to subsequent print jobs.

- **From operation panel**



Select  (Setup) on HOME screen > **Printer settings** > **Print settings** in this order, and then set **Prevent paper abrasion** to **ON**.

- ➔ [Changing Settings from Operation Panel](#)



The edges of the paper are dirty

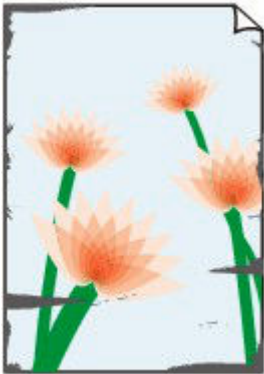

Check 1 Was printing on small paper?

The platen may become dirtied by printing on small paper sizes.

Open the left and right access covers, and clean the platen.

➔ [Cleaning Inside the Printer](#)

Check 2 Is the media type specified in the printer driver the same as the media type in the printer?

The platen may become dirty if the loaded paper does not match the settings. After cleaning the platen, adjust the paper size.

➔ [Cleaning Inside the Printer](#)

When printing with the media type specified in the printer driver, load the specified media type in the printer.

➔ [Loading Rolls in the Printer](#)

➔ [Loading Sheets in the Printer](#)

When printing with the media type loaded in the printer, specify the same media type in the printer driver.

1. To stop printing, press the **Stop** button.
2. Change the type of paper in the printer driver and try printing again.

▶▶▶ Note

- When **Auto (Use Printer Settings)** is selected for the media type, printing is performed with the media type loaded in the printer.
- Click **Get Information** to reflect the paper information set in the printer to the printer driver.

➔ [Printing with Easy Setup](#)

Check 3 When loading paper in the printer, is the media loaded the same as the media type selected on the touch screen?

The platen may become dirty if the loaded paper does not match the settings. After cleaning the platen, adjust the paper size.

➔ [Cleaning Inside the Printer](#)

Select the correct media type in the touch screen menu when loading paper in the printer.

➔ [Loading Rolls in the Printer](#)

➔ [Loading Sheets in the Printer](#)

Check 4 Is the paper creased or curled?

Straighten out the wrinkles or curls and reload the paper.

➔ [Loading Rolls in the Printer](#)

➔ [Loading Sheets in the Printer](#)

Check 5 In the touch screen menu, is **Cut-dust reduction** in **Advanced paper settings** set to **ON**?

A cut dust reduction line is printed at the paper cut position when **Cut-dust reduction** is set to **ON**.

If cutting dust reduction is not required, set **Cut-dust reduction** to **OFF**.

➔ [Menu Structure](#)

Check 6 Is the output guide clean?

Clean the output guide.

➔ [Cleaning Inside the Printer](#)

Check 7 Are the margins of the rolls narrow?

Narrow margins can cause the leading edge of the paper to curl easily, and the raised paper may rub against the head after the ink has landed on it. Make the margins wide.

➔ [Making Margin Settings for Rolls](#)

Check 8 If you are using plain paper, changing the settings from the printer driver may improve the print results.

- For the target setting mode

Select **Poster/Photo** in **Print Target**.

➔ [Printing by setting the Print target](#)

- For the advanced setting mode

Select **Image** in **Print Priority**.

➔ [Printing using the Preferences mode](#)

Check 9 If you are using rolls, are you using the recommended paper and recommended environment?

Using rolls or environments other than those recommended, may result in increased curl and rubbing of the print head. Use the recommended paper and recommended environment.

➔ [List of paper settings \(roll paper\)](#)

Check 10 Set the setting to prevent paper rubbing.

Adjusting the setting to prevent paper abrasion will widen the clearance between the print head and the paper. If you notice abrasion even with the media type set correctly to match the paper, set the printer to prevent paper abrasion using the operation panel or the computer.

This may reduce the print speed.

* Once you have finished printing, undo this setting. Otherwise, it will apply to subsequent print jobs.

• From operation panel



Select  (Setup) on HOME screen > **Printer settings** > **Print settings** in this order, and then set **Prevent paper abrasion** to **ON**.

➔ [Print settings](#)

Check 11 Is the inside of the printer dirty?

During duplex printing, ink may stain the inside of the printer, smudging the printout.

Perform bottom plate cleaning to clean inside of printer.

➔ [Performing Bottom Plate Cleaning](#)

▶▶▶ Note

- To prevent staining inside the printer, be sure to set the correct paper size.

Check 12 If you are using sheets, is the sheet curled?

Align the edges of paper. If paper is curled, flatten it.

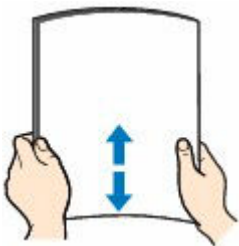

▶▶▶ Important

- Align the edges of paper neatly before loading. Loading paper without aligning the edges may cause paper jams.
- If paper is curled, hold the curled corners and gently bend them in the opposite direction until the paper becomes completely flat.



The surface of the paper is dirty

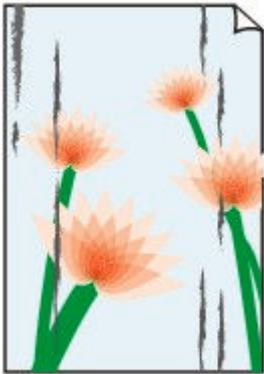

Check 1 Is the paper retainer clean?

Clean the paper retainer.

➔ [Cleaning Inside the Printer](#)

Check 2 Does this paper take longer to dry?

Increase the length of the **Pause between pages** and **Pause between scans** settings from the touch screen menu.

➔ [Specifying the Ink Drying Time](#)

▶▶▶ Note

- When printing on paper that takes longer to dry, the paper may curl during printing and come in contact with the output tray.

In such situations, set an **Ink drying wait time** and an **Ink drying target area** for **Pause between scans** in the touch screen menu.

However, note that printing will now take longer.

Check 3 Is the media type specified in the printer driver the same as the media type in the printer?

The platen may become dirty if the loaded paper does not match the settings. After cleaning the platen, adjust the paper size.

➔ [Cleaning Inside the Printer](#)

When printing with the media type loaded in the printer, specify the same media type in the printer driver.

➔ [Loading Rolls in the Printer](#)

➔ [Loading Sheets in the Printer](#)

When printing with the media type loaded in the printer, specify the same media type in the printer driver.

1. To stop printing, press the **Stop** button.
2. Change the type of paper in the printer driver and try printing again.

▶▶▶ Note

- When **Auto (Use Printer Settings)** is selected for the media type, printing is performed with the media type loaded in the printer.
- Click **Get Information** to reflect the paper information set in the printer to the printer driver.
 - ➔ [Printing with Easy Setup](#)

Check 4 Does the paper type selected in the printer driver or on the touch screen match the actual paper type loaded?

Clean the platen and match the paper type selected in the printer driver or touch screen with the actual paper type loaded.

➔ [Cleaning Inside the Printer](#)

Check 5 Dirt may be removed by letting a blank sheet of paper pass through.

If the roll paper is dirty, perform **Set cut length** several times.

➔ [Set cut length \(feeds and cuts paper rolls by a specified length\)](#)

If the sheet is dirty, perform **Bottom Plate Cleaning**.

➔ [Performing Bottom Plate Cleaning](#)

Check 6 If you are using plain paper, changing the settings from the printer driver may improve the print results.

- For the target setting mode
Select **Poster/Photo** in **Print Target**.
 - ➔ [Printing by setting the Print target](#)
- For the advanced setting mode
Select **Image** in **Print Priority**.
 - ➔ [Printing using the Preferences mode](#)

Check 7 If you are using rolls, are you using the recommended paper and recommended environment?

Using rolls or environments other than those recommended, may result in increased curl and rubbing of the print head. Use the recommended paper and recommended environment.

➔ List of paper settings (roll paper)

Check 8 Set the setting to prevent paper rubbing.

Adjusting the setting to prevent paper abrasion will widen the clearance between the print head and the paper. If you notice abrasion even with the media type set correctly to match the paper, set the printer to prevent paper abrasion using the operation panel or the computer.

This may reduce the print speed.

* Once you have finished printing, undo this setting. Otherwise, it will apply to subsequent print jobs.

- **From operation panel**



Select  (Setup) on HOME screen > **Printer settings** > **Print settings** in this order, and then set **Prevent paper abrasion** to **ON**.

➔ [Print settings](#)

Check 9 Is the inside of the printer dirty?

During duplex printing, ink may stain the inside of the printer, smudging the printout.

Perform bottom plate cleaning to clean inside of printer.

➔ [Performing Bottom Plate Cleaning](#)

▶▶▶ Note

- To prevent staining inside the printer, be sure to set the correct paper size.

Check 10 If you are using sheets, is the sheet curled?

Align the edges of paper. If paper is curled, flatten it.

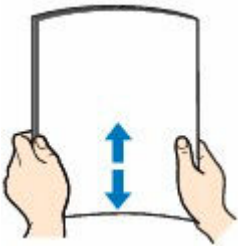

▶▶▶ Important

- Align the edges of paper neatly before loading. Loading paper without aligning the edges may cause paper jams.
- If paper is curled, hold the curled corners and gently bend them in the opposite direction until the paper becomes completely flat.



The back side of the paper is dirty

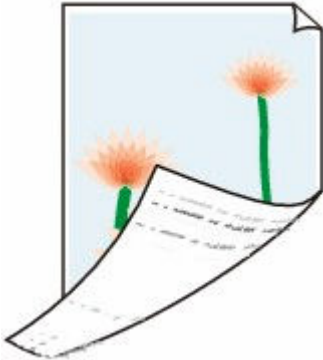

Check 1 Was the previous print job printed on small paper?

Open the scanning unit / cover (TC-20M only) and the access cover, and clean the platen.

➔ [Cleaning Inside the Printer](#)

Check 2 Is **Detect paper width** in the touch screen menu set to **Disable**?

Printing with **Detect paper width** set to **Disable** may cause the platen to be dirtied.

Set **Detect paper width** in the touch screen menu to **Enable**, and then open the scanning unit / cover (TC-20M only) and the access cover, and clean the platen.

➔ [Cleaning Inside the Printer](#)

Check 3 Does this paper take longer to dry?

Increase the length of the **Pause between pages** and **Pause between scans** settings from the touch screen menu.

➔ [Specifying the Ink Drying Time](#)

▶▶▶ Note

- When printing on paper that takes longer to dry, the paper may curl during printing and come in contact with the output tray.

In such situations, set an **Ink drying wait time** and an **Ink drying target area** for **Pause between scans** in the touch screen menu.

However, note that printing will now take longer.

➔ [Menu Structure](#)

- If the platen is dirty, open the scanning unit / cover (TC-20M only) and the access cover, and clean the platen.

Check 4 Is the media type specified in the printer driver the same as the media type in the printer?

The platen may become dirty if the loaded paper does not match the settings. After cleaning the platen, adjust the paper size.

➔ [Cleaning Inside the Printer](#)

When printing with the media type specified in the printer driver, load the specified media type in the printer.

➔ [Loading Rolls in the Printer](#)

➔ [Loading Sheets in the Printer](#)

When printing with the media type loaded in the printer, specify the same media type in the printer driver.

1. To stop printing, press the **Stop** button.
2. Change the type of paper in the printer driver and try printing again.

▶▶▶ Note

- When **Auto (Use Printer Settings)** is selected for the media type, printing is performed with the media type loaded in the printer.
- Click **Get Information** to reflect the paper information set in the printer to the printer driver.

➔ [Printing with Easy Setup](#)

Check 5 Does the paper type selected in the printer driver or on the touch screen match the actual paper type loaded?

Clean the platen and match the paper type selected in the printer driver or touch screen with the actual paper type loaded.

➔ [Cleaning Inside the Printer](#)

Check 6 Dirt may be removed by letting a blank sheet of paper pass through.

If the roll is dirty, repeat the **Set cut length** several times.

➔ [Set cut length \(feeds and cuts paper rolls by a specified length\)](#)

If the sheet is dirty, perform **Bottom Plate Cleaning**.

➔ [Performing Bottom Plate Cleaning](#)



Printed colors are inaccurate



Check 1 Is the Print head nozzle blocked?

Print a test pattern to check the nozzles and see if they are clogged.

➔ [Checking for Nozzle Clogging](#)

Check 2 When printing photos and posters, are the **Print target** settings set correctly?

Do one of the following.

- In the printer driver, change the setting to **Photo (Color)** or **Poster** in **Print Target**.
➔ [Printing by setting the Print target](#)
- In the touch screen menu, select **Printer settings > Print settings > Default print settings > Print quality settings > Print target**, and change the setting to **Photo**. (This is only available when the printer driver's **Media Type** is set to **Auto (Use Printer Settings)**).

➔ [Menu Structure](#)

Check 3 Has color been adjusted in the printer driver?

Follow the steps below to adjust color settings.

- Windows
Adjust the color settings with **Color Mode > Color Settings** in **Advanced Settings** in the printer driver.

➔ [Main Tab Description](#) (Windows)

- macOS
Adjust the color settings in the printer driver **Color Options**.

➔ [Color Options](#) (macOS)

Check 4 Is **Application Color Matching Priority** set to **Off** in a Windows printer driver?

In the printer driver **Layout** sheet, click **Special Settings**, and then set **Application Color Matching Priority** to **On** in the dialog box that appears.

➔ [Layout Tab Description](#) (Windows)

Check 5 Has the computer or monitor color been adjusted?

Take the actions below.

- Refer to the computer and monitor documentation to adjust the colors.
- Adjust the settings of the color management software, referring to the software documentation as needed.

Check 6 Color varies even between printers of the same model due to differences in firmware and printer driver versions, settings, or environment.

Follow these steps to prepare the printing environment.

1. Use the same version of firmware or printer driver.
2. Specify the same value for all settings items.



Documents are printed in monochrome



Check 1 Is **Color Mode** set to **Monochrome**, or **Print Target** set to **CAD (Monochrome Line Drawing)** in a Windows printer driver?

In the **Advanced Settings** of the printer driver, specify **Color** in **Color Mode** and try printing again.

Check 2 Is **Black and White Photo Print** selected in a macOS printer driver?

Deselect **Grayscale Printing** in the printer driver **Quality & Media** settings, and then print again.

Check 3 The print head nozzle may be blocked

Print a test pattern to check the color ink nozzles and see if they are clogged.

➔ [Checking for Nozzle Clogging](#)



Line thickness is not uniform

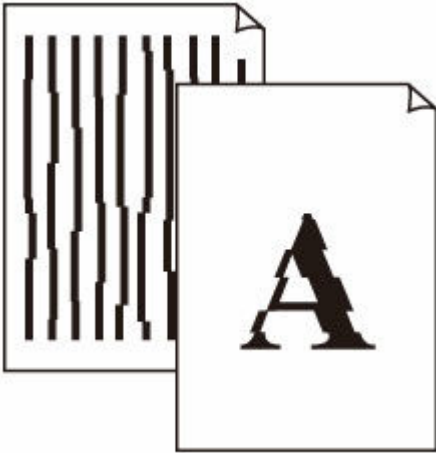

Check 1 Is the media type specified in the printer driver the same as the media type loaded in the printer?

When printing with the media type specified in the printer driver, load the specified media type in the printer.

- ➔ [Loading Rolls in the Printer](#)
- ➔ [Loading Sheets in the Printer](#)

When printing with the media type specified in the printer driver, load the specified media type in the printer.

1. To stop printing, press the **Stop** button.
2. Change the paper type in the printer driver and try printing again.

▶▶▶ Note

- When **Auto (Use Printer Settings)** is selected for the media type, printing is performed with the media type loaded in the printer.
- Click **Get Information** to reflect the paper information set in the printer to the printer driver.
 - ➔ [Printing with Easy Setup](#)

Check 2 When loading paper in the printer, is the media loaded the same as the media type selected on the touch screen?

Select the correct media type in the touch screen menu when loading paper in the printer.

- ➔ [Loading Rolls in the Printer](#)
- ➔ [Loading Sheets in the Printer](#)

Check 3 Adjust the position of the Print head

If the printed result does not look uniform, such as when the lines are misaligned, adjust the position of Print Head.

➔ [Automatic Adjustment to Straighten Lines and Colors](#)

Check 4 Disabling the line and text cleanup process may improve the situation.

If the printed result does not look uniform, such as when the lines are misaligned, adjust the position of Print Head.

- For Windows

Turn off **Cleaner Lines/Text** in the printer driver settings.

➔ [Description of the Layout sheet screen](#)

- For macOS



In the touchscreen menu, select  (Setup) > **Printer settings** > **Print settings** > **Cleaner Lines/Text**, and set to **Disable**.

Check 5 Is **Fast Graphic Process** set to **On** in the 32-bit Windows printer driver **Special Settings** dialog box?

Access the printer driver **Properties** dialog box from **Print** in the **File** menu of the source application, and follow these steps to print.

1. Deselect **Preview before printing** in the **Main** sheet.
2. Deselect **Page Layout** in the **Layout** sheet.
3. Click the **Special Settings** button in the **Layout** sheet, and then set **Fast Graphic Process** to **Off** in the **Special Settings** dialog box that opens.



Lines or colors are misaligned



Check 1 Adjust the position of the Print head

If borders are misaligned or the print results are not uniform, adjust the position of the Print head.

➔ [Automatic Adjustment to Straighten Lines and Colors](#)

Check 2 Is the media type specified in the printer driver the same as the media type loaded in the printer?

When printing with the media type specified in the printer driver, load the specified media type in the printer.

➔ [Loading Rolls in the Printer](#)
➔ [Loading Sheets in the Printer](#)

When printing with the media type specified in the printer driver, load the specified media type in the printer.

1. To stop printing, press the **Stop** button.
2. Change the paper type in the printer driver and try printing again.

▶▶▶ Note

- When **Auto (Use Printer Settings)** is selected for the media type, printing is performed with the media type loaded in the printer.
- Click **Get Information** to reflect the paper information set in the printer to the printer driver.
➔ [Printing with Easy Setup](#)

Check 3 When loading paper in the printer, is the media loaded the same as the media type selected on the touch screen?

Select the correct media type in the touch screen menu when loading paper in the printer.

➔ [Loading Rolls in the Printer](#)
➔ [Loading Sheets in the Printer](#)

Check 4 Is the Roll Paper loaded at an angle?

If there is a gap between the roll paper and the roll holder, reload the roll paper.

➔ [Loading Rolls in the Printer](#)

Check 5 Is **Detect paper width** set to **Disable**?

Set **Detect paper width** in the touch screen menu to **Enable** to load the paper.

➔ [Advanced \(Paper settings\)](#)

Check 6 Is **Skew detection accuracy** in the touch screen menu set to **Loose** or **OFF**?

Set **Skew detection accuracy** to **Standard**, and then reload the paper.

➔ [Advanced \(Paper settings\)](#)

Check 7 If you are using rolls, are you using the recommended paper and recommended environment?

Using rolls or environments other than those recommended, may result in increased curl and rubbing of the print head. Use the recommended paper and recommended environment.

➔ List of paper settings (roll paper)

Check 8 Colors in printed images may be uneven if the **Print Quality** setting is too low

If using Windows, select **Advanced Settings** from the **Main** tab of the printer driver, and then select a higher **Print Quality** setting.

If using macOS, select **Quality & Media** in the printer driver, and then select a higher **Print Quality** setting.

➔ [Changing the Print Quality and Correcting Image Data](#) (Windows)

➔ [Changing the Print Quality and Correcting Image Data](#) (macOS)

Check 9 Is **Unidirectional printing** set to **Disable**?

Using the Unidirectional printing function may reduce the shift of ruled lines. Follow the steps below for unidirectional printing.

- Windows

Open **Paper Detailed Settings** from the **Main** tab of the printer driver, and then select **Unidirectional Printing**.

➔ [Description of the Main sheet screen](#)

- macOS

Open **Advanced Paper Settings** in the printer driver, and then select **Unidirectional Printing**.

➔ [Advanced Paper Settings](#)

➔➔➔ Important

- If any of the following conditions are met in the printer driver settings, the unidirectional printing function setting will be disabled.
 - The **Banner Printing** check box is checked.
 - The paper length exceeds 78.7 in. (2000.0 mm).



The length of the printed image in the paper ejection direction is not accurate

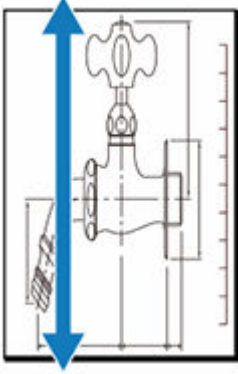

Check 1 Is the media type specified in the printer driver the same as the media type loaded in the printer?

When printing with the media type specified in the printer driver, load the specified media type in the printer.

- ➔ [Loading Rolls in the Printer](#)
- ➔ [Loading Sheets in the Printer](#)

When printing with the media type specified in the printer driver, load the specified media type in the printer.

1. To stop printing, press the **Stop** button.
2. Change the paper type in the printer driver and try printing again.

▶▶▶ Note

- When **Auto (Use Printer Settings)** is selected for the media type, printing is performed with the media type loaded in the printer.
- Click **Get Information** to reflect the paper information set in the printer to the printer driver.
 - ➔ [Printing with Easy Setup](#)

Check 2 When loading paper in the printer, is the media loaded the same as the media type selected on the touch screen?

Select the correct media type in the touch screen menu when loading paper in the printer.

- ➔ [Loading Rolls in the Printer](#)
- ➔ [Loading Sheets in the Printer](#)

Check 3 Perform print quality adjustment to automatically adjust the feed amount.

Perform **Adjust print quality** from **Paper feed adjustment** and **Print alignment pattern** to automatically adjust the feed amount.

➔ [Automatically Adjusting Different Colored Horizontal Streaks](#)

Check 4 Is **Set priority** for **Paper feed adjustment** in the touch screen menu set to **Prioritize print quality**?

Set priority for **Paper feed adjustment** to **Prioritize length accuracy**, and then carry out **Adjust feed length**.

➔ [Automatically Adjusting Different Colored Horizontal Streaks](#)

➔ [Adjusting Line Length](#)



Images are printed crooked



Check 1 Has the roll paper been loaded at an angle?

If there is a gap between the roll paper and roll holder, reload the roll on the roll holder.

➔ [Loading Rolls in the Printer](#)

Check 2 Is **Detect paper width** set to **Disable**?

Set **Detect paper width** in the touch screen menu to **Enable** to load the paper.

➔ [Advanced \(Paper settings\)](#)

Check 3 Is **Skew detection accuracy** in the touch screen menu set to **Loose** or **OFF**?

Set **Skew detection accuracy** to **Standard**, and then reload the paper.

➔ [Advanced \(Paper settings\)](#)

Check 4 Check if the roll holder support is correctly installed.

Check that the roll holder support is installed at the proper width.

➔ [Moving the roll holder support](#)

Also, check that the knurled screws on the roll holder supports are tightened securely.

➔➔➔ Important

- Make sure the knurled screws are tightened until they no longer turn.



Margins are wide



Check 1 Is auto cut being used on printed material with a wide margin on the trailing edge only?

Rolls are advanced a specific amount before cutting to prevent problems with cutting and paper ejection.

This operation is normal.

The specified length varies depending on the media type and the usage environment (humidity). Please refer to the minimum printing length of the paper from paper information list.

If the length of the printed document is shorter than the minimum cut length, an extra edge margin will be added to increase the length of the printed document to the minimum cut length.

➔ List of paper settings (roll paper)

Check 2 Adjust the margins.

➔ [Making Margin Settings for Rolls](#)

Cannot Configure Network Settings

- **Message Appears on Computer During Setup**
- **Cannot Proceed beyond Printer Connection Screen/Connect Cable Screen**
- **"Failed to connect to the wireless router." Appears**
- **Printer Cannot Be Used After Replacing Wireless Router or Changed Router Settings**
- **Error Occurs During Wi-Fi Setup**
- **Taking Time to Setup Process (Windows)**

Message Appears on Computer During Setup

- ➔ [Screen to Enter Password Appears During Setup \(Windows\)](#)
- ➔ [Encryption Settings Screen Appears When Wireless Router Selected \(Windows\)](#)
- ➔ ["You have connected the printer to the non encrypted wireless network" Appears](#)

Screen to Enter Password Appears During Setup (Windows)

A

If the printer is set up for use with a network and an administrator password has been set, a screen asking you to enter the password appears.

Enter the same password as that specified for the printer.

Note

- An administrator password is already set for the printer at the time of purchase.

For details:

- ➔ [Setting Administrator Password on Operation Panel](#)
- ➔ [Forgot Administrator Password of Printer](#)

Encryption Settings Screen Appears When Wireless Router Selected (Windows)

A

This screen appears automatically if the selected wireless router is encrypted. Set the same encryption settings as those set for the wireless router.

"You have connected the printer to the non encrypted wireless network" Appears

A

Security is not configured on the wireless router. The printer can still be used, so continue the setup procedure and complete it.

Important

- If you connect to a network that is not protected with security measures, there is a risk of disclosing data such as your personal information to a third party.



Cannot Proceed beyond Printer Connection Screen/Connect Cable Screen



If you cannot proceed beyond the **Printer Connection** screen or the **Connect Cable** screen, check the following.

Check 1 Make sure USB cable is securely plugged in to printer and computer.

Connect the printer and the computer using a USB cable as the illustration below. The USB port is located at the back side of the printer.

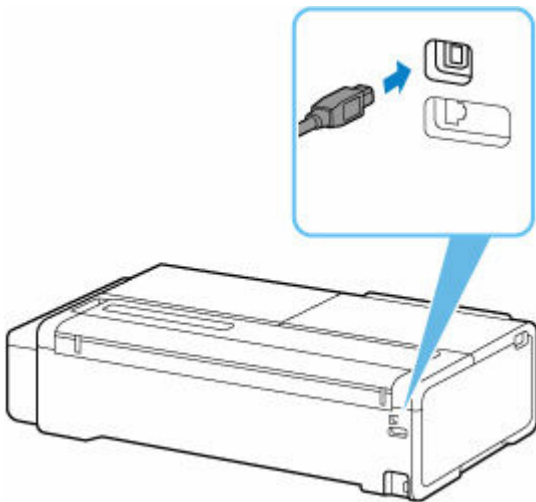

Check the items below only if you cannot proceed beyond the Printer Connection screen.

Check 2 Follow procedure below to connect printer and computer again.

▶▶▶ Important

- For macOS, make sure the lock icon is on the lower left of the **Printers & Scanners** screen.



If the  icon (locked) is displayed, click the icon to unlock. (The administrator name and the password are necessary to unlock.)

1. Turn off printer.
2. Unplug USB cable from printer and computer and connect it again.
3. Turn on printer.

Check 3 If you cannot resolve problem, follow procedure below to reinstall printer driver.

1. Exit setup.
2. Turn off printer.
3. Restart computer.
4. Make sure you have no application software running.
5. Refer to Setup Guide for setup.



"Failed to connect to the wireless router." Appears



Each time you perform each check, select **OK** on the error screen to clear the error and set up the printer again.

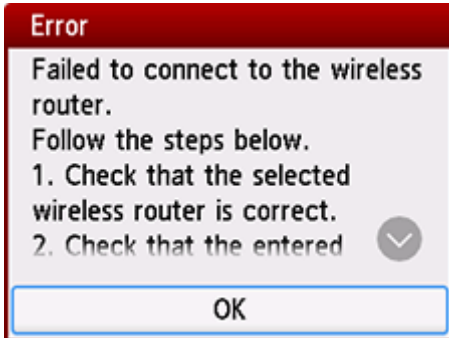

- ➔ [When Security Type is WPA/WPA2/WPA3](#)
- ➔ [When Security Type is set to Disable](#)

When Security Type is WPA/WPA2/WPA3

Check 1 Check the password entered for the wireless router is correct.

If the password you entered is incorrect, enter the correct password.



Check 2 Check the wireless router's settings.

If the wireless router's DHCP function is off, turn it on and redo the wireless connection settings.

Check 3 Check the MAC address filtering's settings.

If MAC address filtering is enabled on the wireless router, change the settings to accept the printer's MAC address.

To check the printer's MAC address, follow these steps.

1. Select  (Information) on the HOME screen.
2. Select  **System information**.
3. Check the **MAC address (Wi-Fi)**.

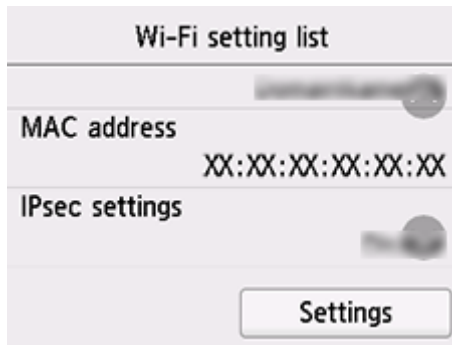

Check 4 Check the wireless router's security protocol (encryption method) settings.

If the wireless router is set to communicate using the IEEE802.11n standard only and encryption is set to TKIP, change the encryption standard to something other than TKIP or change the communication standard, and then redo the wireless connection settings.

If the encryption standard is set to TKIP, IEEE802.11n cannot be used as the communication standard.

For details on changing the wireless router settings, see the wireless router manual or contact its manufacturer.

When Security Type is set to Disable

Check Is the wireless router turned on?

If it is already turned on, turn it off, and then turn it back on.

Do not proceed to the next screen of this guide until the power is turned on. The connection to the wireless router will be temporarily disabled.



Printer Cannot Be Used After Replacing Wireless Router or Changed Router Settings



When you replace a wireless router, redo the network setup for the printer according to the replaced one. See the Setup Guide and perform setup.

▶▶▶ Note

- Wi-Fi Connection Assistant allows you to diagnose and repair the network status. Select the link below to download Wi-Fi Connection Assistant and install it.
 - ➔ [Checking Printer Connection Status Using Wi-Fi Connection Assistant](#)

If this does not solve the problem, see below.

- ➔ [Cannot Communicate with Printer After Enabling MAC/IP Address Filtering or Encryption Key on Wireless Router](#)
- ➔ [With Encryption On, Cannot Communicate with Printer After Changing Encryption Type at Wireless Router](#)



Cannot Communicate with Printer After Enabling MAC/IP Address Filtering or Encryption Key on Wireless Router



Check 1 Check wireless router setting.

To check the wireless router setting, see the instruction manual provided with the wireless router or contact its manufacturer. Make sure the computer and the wireless router can communicate with each other under this setting.

Check 2 If filtering MAC addresses or IP addresses at wireless router, check that MAC addresses or IP addresses for computer, network device, and printer are registered.

Check 3 If using WPA/WPA2/WPA3 key or a password, make sure encryption key for computer, network device, and printer matches key set for wireless router.

The length or format of the Wi-Fi password and authentication method must be identical among the wireless router, the printer, and your computer.

For details, see [Setting an Encryption Key](#).

Q With Encryption On, Cannot Communicate with Printer After Changing Encryption Type at Wireless Router

A

If you change the encryption type for the printer and it subsequently cannot communicate with the computer, make sure the encryption type for the computer and the wireless router matches the type set for the printer.



Error Occurs During Wi-Fi Setup



Check 1 Check wireless router location

Make sure the printer is not placed far away from the wireless router.

The printer can be up to 50 m (164 ft.) from the wireless router indoors. Make sure the printer is close enough to the wireless router to be used.

Place the printer and wireless router where there are no obstacles between them. Wireless communication between different rooms or floors is generally poor. Wireless communication can be impeded by building materials containing metal or concrete. If the printer cannot communicate with the computer over a Wi-Fi due to a wall, place the printer and the computer in the same room.

In addition, if a device like a microwave oven that emits radio waves of the same frequency bandwidth as a wireless router is nearby, it may cause interference. Place the wireless router as far away from interference sources as possible.

Check 2 Check wireless router settings

The printer and wireless router should be connected using 2.4 GHz bandwidth. Make sure the wireless router for the printer's destination is configured to use 2.4 GHz bandwidth.

▶▶▶ Note

- Some wireless routers distinguish network names (SSIDs) by the last alphanumeric character according to their bandwidth (2.4 GHz or 5 GHz) or purpose (for computer or game machine).

To check the network name (SSID) of the wireless router the printer is connected to, print the network settings.

➔ [Printing Network Settings](#)

For details, see the instruction manual supplied with the wireless router or contact the manufacturer.

If you use an encryption key, specify it for the network name (SSID) you are using.

For details, see [Setting an Encryption Key](#).

▶▶▶ Note

- Pressing a button on the wireless router allows you to connect the printer and wireless router.



➔ [WPS Connection](#)

- For manual setup:

➔ [WPS \(PIN Code\) Connection](#)

If the measures above do not resolve the problem, make sure the DHCP of the wireless router is enabled.



Taking Time to Setup Process (Windows)



If Windows update starts during setup, or if you perform setup while Windows update is in progress, it may take a while to register the printer or to perform other processes.

Wait for a while. This is not a malfunction.

Cannot Find Printer on Network

- **Cannot Connect Printer to Network**
- **Cannot Find Printer During Setup**
- **Cannot Find Printer while Using Wi-Fi**
- **Cannot Find Printer while Using Wired LAN**
- **Searching Printer by IP Address or Host Name During Setup**



Cannot Connect Printer to Network



Check

Is the Ethernet cable connected correctly to the printer's wired LAN connector?

Make sure the printer is connected to the network with the correct Ethernet cable, and then turn the printer on. For instructions on connecting the cable, refer to the Setup Guide.

Cannot Find Printer During Setup

If you cannot find the printer on network during setup, check the following.

No Printers Found

Click [Next], and then set up your printer by following the displayed guide.



[If your printer is not found even after reading the guide](#)

Back to Top **Next**

When you complete all the checking, try to set up from the beginning.

Items to check for Wi-Fi

Step 1 Check the basic items for Wi-Fi

1. Check power status

Are printer and network device (router, etc.) turned on?

Stop setting up, and check if the router (modem) is turned on and then check if the printer is turned on.

1. Check if network devices such as router are turned on.

If network devices are not turned on, turn on the power. If the network devices are on, turn them off and on again.

It may take a while for the network device to become ready for use once they are turned on.

Proceed once the network devices such as router are ready for use.

2. Check if the printer is turned on

If printer is not turned on, turn on the power. If the printer is on, turn them off and on again.

2. Check PC network connection

Can you view any web pages on your computer? Make sure the computer and network device (wireless router, etc.) are configured and the computer is connected to the network.

If you cannot view web pages on your computer, check wireless router network connection settings, such as IP address filtering, MAC address filtering, and DHCP function.

For more on checking the settings of the wireless router, refer to the instruction manual supplied with the wireless router or contact the manufacturer.

Important

- Depending on the wireless router, note that different network name (SSID) is assigned for a bandwidth (2.4 GHz or 5 GHz) or its usage (for PC or game machine), using alphanumeric characters at the end of network name (SSID).

Once you complete checking the wireless router, configure the network settings for your computer. For the procedures, refer to the instruction manual supplied with the computer, or contact the manufacturer.

Once you complete setting up the wireless router and your computer, configure the settings on your computer in order to view web pages, using the information of the wireless router.

3. Check printer's Wi-Fi settings

Make sure the  or  icon is displayed on the touch screen.

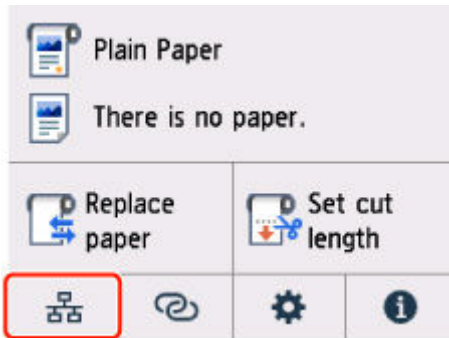

If icon is not displayed:

The printer is not set to enable wireless communication. Change the printer settings in order to use Wi-Fi. Turn on wireless communication on the printer.



If icon is displayed:



 icon indicates that the wireless router and the printer are not connected. Reconsider the locations of the wireless router and the printer.

- Checking the location of wireless router:

After checking the wireless router setting, make sure the printer is not placed too far away from the wireless router. The printer can be up to 164 ft. (50 m) from the wireless router indoors if unobstructed. Make sure the printer is close enough to the wireless router to be used.

Place the printer and wireless router where there are no obstacles between them. Wireless communication between different rooms or floors is generally poor. Wireless communication can be impeded by building materials containing metal or concrete. If the printer cannot communicate with the computer over a Wi-Fi due to a wall, place the printer and the computer in the same room.

In addition, if a device like a microwave oven that emits radio waves of the same frequency bandwidth as a wireless router is nearby, it may cause interference. Place the wireless router as far away from interference sources as possible.

- Checking the location of printer:

Make sure that the printer is not placed behind an object. The printer may not be connected when placed behind a wall or on a shelf. Try to place the printer in a location where there is no obstacle.

For details, see the instruction manual supplied with the wireless router or contact the manufacturer.

Step 2 Solve the Problem, Using Wi-Fi Connection Assistant

Diagnose and repair the network connections using Wi-Fi Connection Assistant.

Download Wi-Fi Connection Assistant from the below page, and install it on your computer.

➡ Checking Printer Connection Status Using Wi-Fi Connection Assistant

If you can connect to the network, try to set up from the beginning.

Items to check for wired LAN

Step 1 Check the basic items for wired LAN

1. Check the power and LAN Cable

When the printer cannot be found on the setup screen, using wired LAN connection setup, make sure that all the network devices are connected with the router and the hub via LAN cables and that all the devices are turned on.

If LAN cable is not connected:

Connect the router, hub, computer and printer via LAN cables.

Make sure the printer is turned on.

Make sure the printer is turned on, and make sure that the router and the hub are turned on.

If LAN cable is connected, and printer and network device are off:

Turn on printer or network device.

If LAN cable is connected, and printer and network device are on:

If they are on, turn them off and on again.

▶▶▶ Note

- It may take a while for the printer and network device to become ready for use once they are turned on again. After turning it on, wait for a while and proceed.

2. Check PC network connection

Can you view any web pages on your computer? Make sure the computer and network device (router, etc.) are configured and the computer is connected to the network.

If you cannot view web pages, unplug the cable connected to the router's WAN side. Connect the cable directly to the computer to see if you can view web pages on the Internet.

Check the settings for the router if you were able to view web pages. For details on checking the settings of the router, refer to the instruction manual supplied with the router or contact the manufacturer. Refer also to the instruction manual regarding the connection of the provider.

Once you complete checking the router, configure the network settings of your computer. For the procedures, refer to the instruction manual supplied with the computer, or contact the manufacturer.

Once you complete setting up the router and your computer, configure the settings on your computer to view web pages, using the information of the router.

Proceed once you can view web pages on your computer.

3. Check printer's wired LAN settings



Make sure the icon is displayed on the touch screen.

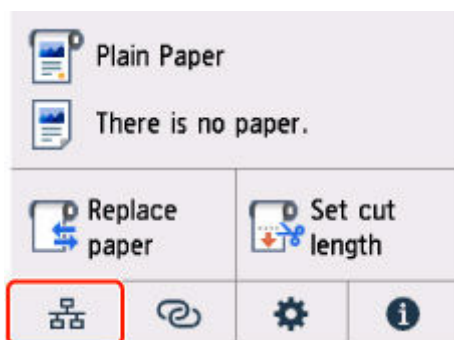

If icon is not displayed:

The printer is not set to enable wired communication. Change the printer settings in order to use wired LAN.

When you complete checking [Step 1] above, try to set up from the beginning.

If the printer cannot be detected after trying to set up from the beginning, proceed to [Step 2].

Step 2 Solve the Problem, Using Wi-Fi Connection Assistant

Diagnose and repair the network connections using Wi-Fi Connection Assistant.

Download Wi-Fi Connection Assistant from the below page, and install it on your computer.

➡ [Checking Printer Connection Status Using Wi-Fi Connection Assistant](#)

If you can connect to the network, try to set up from the beginning.



Cannot Find Printer while Using Wi-Fi





Check 1 Make sure printer is turned on.

If not, make sure the printer is securely plugged in and press **ON** button to turn on.

The **ON** lamp flashes while the printer is initializing. Wait until the **ON** lamp stops flashing and remains lit.

Check 2 Check the network status on the touch screen.



If the  icon is displayed, or only the  icon is displayed, Wi-Fi is disabled.

Set **Enable/disable Wi-Fi** in the touch screen menu to **Enable**.



If the  icon is displayed, see Check 3 or later checking items to make sure whether printer setup is complete or the settings of wireless router to connect are correct.

Check 3 Make sure printer setup is complete on the computer.

If it is not, perform setup.

- For Windows:
Perform setup using the Setup CD-ROM or from Setup Guide.
- For macOS:
Perform setup from Setup Guide.

▶▶▶ Note

- Wi-Fi Connection Assistant allows you to diagnose and repair the network status.

Select the link below to download Wi-Fi Connection Assistant and install it.

➔ [Checking Printer Connection Status Using Wi-Fi Connection Assistant](#)

Check 4 Make sure printer and wireless router network settings match.

Make sure the network settings of the printer (e.g. wireless router name, SSID, network key, etc.) are identical with those of the wireless router.

To check the settings of the wireless router, refer to the instruction manual provided with it or contact its manufacturer.

▶▶▶ Note

- Use 2.4 GHz frequency band to connect to a wireless router. Match the SSID set for the printer with that for 2.4 GHz frequency band of the wireless router.

To check the SSID set for the printer, print out the network setting information or use the operation panel to display it.

- Display on the touch screen.

➔ [LAN settings](#)

- Print the network settings.

➔ [Printing Network Settings](#)

▶▶▶ Note

- Wi-Fi Connection Assistant allows you to diagnose and repair the network status.

Select the link below to download Wi-Fi Connection Assistant and install it.

➔ [Checking Printer Connection Status Using Wi-Fi Connection Assistant](#)

Check 5 Make sure the printer is not placed too far away from the wireless router.

If the distance between the printer and wireless router is too far, wireless communication becomes poor. Place the printer and wireless router close to each other.

▶▶▶ Note

- Though an antenna is attached to most wireless routers, note that some of them have it inside.

Check 6 Make sure wireless signal is strong. Monitor signal strength and move printer and wireless router as necessary.

Place the printer and wireless router where there are no obstacles between them. Wireless communication between different rooms or floors is generally poor. Wireless communication can be impeded by building materials containing metal or concrete. If the printer cannot communicate with the computer over a Wi-Fi due to a wall, place the printer and the computer in the same room.

In addition, if a device like a microwave oven that emits radio waves of the same frequency bandwidth as a wireless router is nearby, it may cause interference. Place the wireless router as far away from interference sources as possible.

▶▶▶ Note

- Wi-Fi Connection Assistant allows you to diagnose and repair the network status.

Select the link below to download Wi-Fi Connection Assistant and install it.

➔ [Checking Printer Connection Status Using Wi-Fi Connection Assistant](#)

Check 7 Make sure the computer is connected to the wireless router.

For more on how to check the computer settings or connection status, see your computer instruction manual or contact its manufacturer.

▶▶▶ Note

- If you use a smartphone or tablet, make sure the Wi-Fi is enabled on the device.

Check 8 Make sure **Enable bidirectional support** is selected in the **Ports** sheet of the properties dialog box of the printer driver. (Windows)

If not, select it to enable bidirectional support.

Check 9 Make sure security software's firewall is off.

If your security software's firewall is on, a message may appear warning you that Canon software is attempting to access the network. If this warning message appears, set security software to always allow access.

If you are using any programs that switch between network environments, check their settings.

Check 10 If printer is connected to an AirPort Base Station via LAN, make sure you use alphanumeric characters for network identifier (SSID). (macOS)

If the problem is not resolved, redo setup.

- For Windows:
Perform setup using the Setup CD-ROM or from Setup Guide.
- For macOS:
Perform setup from Setup Guide.



Cannot Find Printer while Using Wired LAN



Check 1 Make sure printer is turned on.

If not, make sure the printer is securely plugged in and press **ON** button to turn on.

The **ON** lamp flashes while the printer is initializing. Wait until the **ON** lamp stops flashing and remains lit.

Check 2 Make sure LAN cable is connected properly.

Make sure the printer is connected to the router with the LAN cable. If the LAN cable is loose, connect the cable properly.

If the LAN cable is connected to the WAN side of the router, connect the cable to the LAN side of the router.



Check 3 Is  icon displayed on touch screen?

If the icon is not displayed, wired LAN is disabled.

Select the network icon on the HOME screen, and select **Wired LAN > Enable/disable Wired LAN > Enable**.

Searching Printer by IP Address or Host Name During Setup

If the printer cannot be found on the **Select Printer** screen, search for the printer by an IP address or host name. Click **Search By IP Address** on the screen which appears by clicking **Printer Not Found**. The screen to select searching criteria appears.

1. Check printer's IP address or host name.

To check the printer's IP Address or host name, print out the network settings information or use the touch screen to display it.

- Display on the touch screen.

➔ [LAN settings](#)

- Print the network settings.

➔ [Printing Network Settings](#)

▶▶▶ Note

- If you use the printer in an office, ask the network administrator.

2. Specify searching method.

Select one of the methods below.

Specify Printer Search Method

Search by IPv4 address **A**

Search by IPv6 address **B**

Search by host name **C**

In order to search for your printer by IP address, you must first assign an IP address to the printer. For more details, click [\[Instructions\]](#).

[Instructions](#)

Back **Next**

A: Search by IPv4 address

Select to search for printers by IPv4 address.

B: Search by IPv6 address

Select to search for printers by IPv6 address.

C: Search by host name

Select to search for printers by host name. A host name is referred to as LLMNR host name or Bonjour name.

3. Enter IP address or host name and click **Next**.

Printer search starts.

If an error screen appears:

Resolve the error according to the instruction on the screen.

If the IP address you entered is already used for another device, follow the procedure below to specify printer's IP address.

1. On the HOME screen, select the **Network** icon.

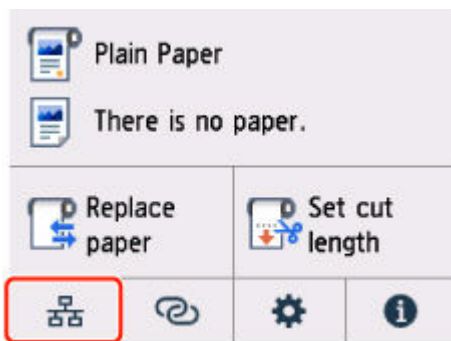

Depending on the current LAN status, the icon displayed on the button may differ.

➔ [Home Screen Menu Composition](#)

If you specify the administrator password, enter the password.

2. Select **Wi-Fi**.

3. Select **Advanced**.

4. Select **TCP/IP settings**.

- If you specify IPv4 address:

1. Select **IPv4**.

2. Select **Yes** on the displayed screen.

3. Select **IP address**.

4. Select **Manual setup**.

Selecting **Auto setup** specifies the IP address automatically.

5. Enter IP address.
6. Select **OK**.
7. Enter subnet mask.
8. Select **OK**.
9. Enter default gateway.
10. Select **OK**.

The IPv4 address has been specified.

- **If you specify IPv6 address:**

1. Select **IPv6**.
2. Select **Yes** on the displayed screen.
3. Select **Enable/disable IPv6**.
4. Select **Enable**.

The IPv6 address has been specified.

Important

- If firewall is enabled on the computer, printers on a different subnet may not be detected. Disable firewall.

If firewall interferes with printer search:

- **If a firewall message appears:**

If a firewall message appears warning that Canon software is attempting to access the network, set the security software to allow access.

After allowing the software to access, specify the IP address or host name and search for printers again.

If the printer is found, follow the instructions on the screen to continue to set up the network communication.

- **If no firewall message appears:**

Temporarily disable the firewall and specify the IP address or host name to search for printers again.

After the setup is complete, re-enable the firewall.

»» Note

- For more on firewall settings of your operating system or security software, see instruction manual or contact its manufacturer.

Cannot Print over Network

- **Cannot Print over TCP/IP Network**
- **Cannot Print over Bonjour networks**
- **Cannot Print Using AirPrint**



Cannot Print over TCP/IP Network



Check 1 Is the printer's IP address configured correctly?

Make sure the printer's IP address is configured correctly.

▶▶▶ Note

- For Windows, you can configure the printer's IP address using Wi-Fi Connection Assistant.
For details, refer to "Performing/Changing Network Settings" > "Performing Network Settings" in Wi-Fi Connection Assistant Guide.
➔ [Wi-Fi Connection Assistant Guide](#)

Check 2 Are the printer's TCP/IP network settings configured correctly?

Make sure the printer's TCP/IP network settings are configured correctly.

Check 3 Is the computer you are trying to print from configured correctly?

Make sure the computer's TCP/IP network settings are configured correctly.



Cannot Print over Bonjour networks



Check 1 Is the computer you are trying to print from configured correctly?

Make sure the computer is configured correctly.

Check 2 Are the computer and printer on the same network?

Due to the nature of Bonjour, printing may not be possible if the printer is on another network behind a router. Make sure the computer and printer are on the same network. For information about network settings, ask your network administrator.

Check 3 Are the printer's Bonjour settings configured correctly?

Make sure the Bonjour settings are configured correctly.



Cannot Print Using AirPrint



Check 1 Make sure printer is turned on.

If the printer is turned on, turn it off and back on, and then check whether the issue is resolved.

Check 2 Make sure printer is registered to your computer.

Check 3 Make sure printer is connected by LAN to same network subnet as AirPrint compliant device when printing over LAN.

Check 4 Make sure printer has enough paper and ink.

Check 5 Make sure no error message is displayed on printer's touch screen.

Network Connection Problems

- **Network Settings and Common Problems**
- **Cannot Connect to the Printer**
- **Network Key (Password) Unknown**
- **Forgot Administrator Password of Printer**
- **Checking Network Information**
- **Restoring to Factory Defaults**
- **Cannot Access to Internet on Wi-Fi from Communication Device**

Network Settings and Common Problems

Here are frequently asked questions on network.

Cannot Find Printer

- ➔ [Cannot Find Printer During Setup](#)
- ➔ [Cannot Proceed beyond Printer Connection Screen/Connect Cable Screen](#)
- ➔ [Searching Printer by IP Address or Host Name During Setup](#)
- ➔ [Cannot Find Printer while Using Wi-Fi](#)
- ➔ [Cannot Find Printer while Using Wired LAN](#)
- ➔ [Cannot Print Using AirPrint](#)

Cannot Print or Connect

- ➔ [Cannot Connect Printer to Network](#)
- ➔ [Cannot Print over TCP/IP Network](#)
- ➔ [Cannot Print over Bonjour networks](#)
- ➔ [Cannot Connect to the Printer](#)

LAN Setting Tips/Changing LAN Settings

- ➔ [Printer Connection Methods](#)
- ➔ [Default Network Settings](#)
- ➔ [Another Printer Found with Same Name](#)
- ➔ [Printing Network Settings](#)
- ➔ [Network Status and Troubleshooting](#)

Cannot Connect to the Printer

- ➔ [Cannot Connect to a Printer after Network Configuration Changes](#)
- ➔ [Cannot Connect to a Printer via Wi-Fi](#)
- ➔ [Cannot Connect to a Printer through Wireless Direct](#)
- ➔ [Cannot Connect to a Printer via Wired LAN](#)
- ➔ [Cannot Print through Network](#)

Cannot Connect to a Printer after Network Configuration Changes

It may take a while for the computer to obtain an IP address, or you may need to restart your computer. Make sure the computer has obtained a valid IP address, and try again to find the printer.

Cannot Connect to a Printer via Wi-Fi

Check 1 Check the power status of printer and devices (e.g. wireless router or computer) connected to the network.

Turn on the printer or devices.

If the power is already turned on, turn it off and on again.

It may be necessary to resolve wireless router problems (e.g. update interval of a key, problems of DHCP update interval, energy saving mode, etc.) or to update the wireless router firmware.

For details, contact the manufacturer of your wireless router.

Check 2 Can you view any web pages on your computer?

Make sure your computer is connected to the wireless router properly.

For more on checking computer settings or connection status, see the instruction manual supplied with the computer or contact the manufacturer.

Check 3 Is the printer connected to the wireless router?

Use the icon on the touch screen to check the connection status between the printer and wireless router. If the



icon is not displayed, Wi-Fi is disabled. Turn on wireless communication on the printer.

Check 4 Make sure the printer and wireless router network settings match.

Make sure the network settings of the printer (e.g. wireless router name, SSID, network key, etc.) are identical with those of the wireless router.

To check the settings of the wireless router, refer to the instruction manual provided with it or contact its manufacturer.

To check the current network settings of the printer, print out the network setting information.

➔ [Printing Network Settings](#)

➤➤➤ Note

- Wi-Fi Connection Assistant allows you to diagnose and repair the network status.

Select the link below to download Wi-Fi Connection Assistant and install it.

➔ [Checking Printer Connection Status Using Wi-Fi Connection Assistant](#)

Check 5 Make sure the printer is not placed too far away from the wireless router.

If the distance between the printer and wireless router is too far, wireless communication becomes poor. Place the printer and wireless router close to each other.

➤➤➤ Note

- Though an antenna is attached to most wireless routers, note that some of them have it inside.

Check 6 Make sure wireless signal is strong. Monitor signal status and move printer and wireless router as necessary.

Place the printer and wireless router where there are no obstacles between them. Wireless communication between different rooms or floors is generally poor. Wireless communication can be impeded by building materials containing metal or concrete. If the printer cannot communicate with the computer over a Wi-Fi due to a wall, place the printer and the computer in the same room.

In addition, if a device like a microwave oven that emits radio waves of the same frequency bandwidth as a wireless router is nearby, it may cause interference. Place the wireless router as far away from interference sources as possible.

➤➤➤ Note

- Wi-Fi Connection Assistant allows you to diagnose and repair the network status.

Select the link below to download Wi-Fi Connection Assistant and install it.

➔ [Checking Printer Connection Status Using Wi-Fi Connection Assistant](#)

Check 7 Make sure of the Wi-Fi channel numbers used for your computer.

You need to have the same Wi-Fi channel number that you are using for the wireless router as your computer. It is normally set in the way that you can use all the Wi-Fi channels. However, when the channels that you are using are restricted, the Wi-Fi channels do not match.

See the instruction manual provided with your computer and check the Wi-Fi channel number available for your computer.

Check 8 Make sure channel set on wireless router is a usable channel as confirmed in Check 7.

If it is not, change the channel set on the wireless router.

Check 9 Make sure security software's firewall is off.

If your security software's firewall is on, a message may appear warning you that Canon software is attempting to access the network. If this warning message appears, set security software to always allow access.

If you are using any programs that switch between network environments, check their settings.

Check 10 If printer is connected to an AirPort Base Station via LAN, make sure you use alphanumeric characters for network identifier (SSID). (macOS)

If the problem is not resolved, redo setup.

- For Windows:
Perform setup using the Setup CD-ROM or from Setup Guide.
- For macOS:
Perform setup from Setup Guide.



Cannot Connect to a Printer through Wireless Direct



Check 1 Check the power status of printer and other devices (smartphone or tablet).

Turn on the printer or devices.

If the power is already turned on, turn it off and on again.

Check 2 Is the  icon displayed on the touch screen?

If not, Wireless Direct is disabled. Turn on Wireless Direct.

Check 3 Check the settings of your device (smartphone/tablet).

Make sure Wi-Fi is enabled on your device.

For details, refer to your device's instruction manual.

Check 4 Make sure printer is selected as connection for device (e.g. smartphone or tablet).

Select the identifier for Wireless Direct (SSID) specified for the printer as the connection destination for devices.

Check the destination on your device.

For details, refer to your device's instruction manual or visit the manufacturer's website.

To check the identifier for wireless direct (SSID) specified for the printer, display it using the operation panel of the printer or print out the network setting information of the printer.

- Display on the touch screen.

➔ [LAN settings](#)

- Print the network settings.

➔ [Printing Network Settings](#)

Check 5 Have you entered the proper password specified for the Wireless Direct?

To check the password specified for the printer, display it using the operation panel of the printer or print out the network setting information of the printer.

- Display on the touch screen.

➔ [LAN settings](#)

- Print the network settings.

➔ [Printing Network Settings](#)

Check 6 Make sure the printer is not placed too far away from the device.

If the distance between the printer and device is too far, wireless communication becomes poor. Place the printer and device close to each other.

Check 7 Make sure 5 devices are already connected.

Wireless Direct does not allow more than 5 devices to be connected.

Cannot Connect to a Printer via Wired LAN

Check 1 Make sure the printer is turned on.

Check 2 Make sure the LAN cable is connected properly.

Make sure the printer is connected to the router with the LAN cable. If the LAN cable is loose, connect the cable properly.

If the LAN cable is connected to the WAN side of the router, connect the cable to the LAN side of the router.

If the problem is not resolved, redo setup.

- For Windows:

Perform setup using the Setup CD-ROM or from Setup Guide.

- For macOS:

Perform setup from Setup Guide.

Cannot Print through Network

Check 1 Make sure the computer is connected to the wireless router.

For more on how to check the computer settings or connection status, see your computer instruction manual or contact its manufacturer.

Check 2 If the printer driver is not installed, install it. (Windows)

Install the printer driver using the Setup CD-ROM or install it from Setup Guide.

Check 3 When using Wi-Fi, make sure wireless router does not restrict which computers can access it.

For more on connecting to and setting up your wireless router, see the wireless router instruction manual or contact its manufacturer.

Network Key (Password) Unknown

►►► Note

- Wi-Fi Connection Assistant allows you to diagnose and repair the network status. Download it from the web page.
 - ➔ For Windows
 - ➔ For macOS

If the problem persists after diagnosis and repair with Wi-Fi Connection Assistant, check the following items.

- ➔ [WPA/WPA2/WPA3 Key Set for Wireless Router Unknown, Cannot Connect](#)
- ➔ [Setting an Encryption Key](#)

WPA/WPA2/WPA3 Key Set for Wireless Router Unknown, Cannot Connect

For more on setting up a wireless router, see the instruction manual provided with the wireless router or contact its manufacturer. Make sure your computer can communicate with the wireless router.

Setting an Encryption Key

For more on setting up a wireless router, see the instruction manual provided with the wireless router or contact its manufacturer. Make sure your computer can communicate with the wireless router.

Selecting WPA, WPA2, or WPA2/WPA3 is recommended for security reason. If your wireless router is compatible with WPA2/WPA3, you can also use WPA2 or WPA3.

- **Using WPA/WPA2/WPA3 (Windows)**

The authentication method, Wi-Fi password, and dynamic encryption type must be identical among the wireless router, the printer, and your computer.

Enter the Wi-Fi password configured on the wireless router.

Either TKIP (basic encryption) or AES (secure encryption) is selected automatically as the dynamic encryption method.

For details, see [If WPA/WPA2 Details Screen Appears](#).

►►► Note

- See the product specifications for supported authentication types.
 - ➔ [Network Specifications](#)

▶▶ Note

- If the printer is connected to an AirPort Base Station via LAN:

If the printer is connected to an AirPort Base Station via a LAN, check the settings in **Wireless Security** of **AirPort Utility**.

- Select **1** for the password to use. Otherwise, computer will not be able to communicate with printer via the wireless router.



Forgot Administrator Password of Printer



Select  (Setup) on HOME screen > **Printer settings** > **Reset settings** > **Reset all**, in order to restore to default administrator password.

➔ [Reset settings](#)

After initializing the printer settings, redo setup.

➔ [Setup Guide](#)

Checking Network Information

- ➔ [Checking Printer IP Address or MAC Address](#)
- ➔ [Checking Computer IP Address or MAC Address](#)
- ➔ [Checking Communication Between the Computer, the Printer, and the Wireless Router](#)
- ➔ [Checking Network Setting Information](#)

Checking Printer IP Address or MAC Address

To check the printer's IP Address or MAC address, print out the network settings information or use the operation panel to display it.

- Display on the touch screen.

➔ [LAN settings](#)

- Print the network settings.

➔ [Printing Network Settings](#)

For Windows, you can check the network setting information on the computer screen.

- ➔ Canon Wi-Fi Connection Assistant Screen

Checking Computer IP Address or MAC Address

To check the IP Address or MAC address of your computer, follow the instructions below.

- **For Windows:**

1. Select **Command Prompt** from **Start**.

2. Enter "ipconfig/all" and press **Enter**.

The IP address and MAC address of your computer appear. If your computer is not connected to a network, the IP address does not appear.

- **For macOS:**

1. Select **System Preferences** from Apple menu, and then click **Network**.

2. Make sure network interface used by computer is selected, and then click **Advanced**.

Make sure **Wi-Fi** is selected as network interface.

3. Click **TCP/IP** to check the IP address, or click **Hardware** to check the MAC address.

Checking Communication Between the Computer, the Printer, and the Wireless Router

A

Perform a ping test to check if communication is taking place.

- **For Windows:**

1. Select **Command Prompt** from **Start**.

2. Type the ping command and press **Enter**.

The ping command is as follows: ping XXX.XXX.XXX.XXX

"XXX.XXX.XXX.XXX" is the IP address of the target device.

If communication is taking place, a message like the one shown below appears.

Reply from XXX.XXX.XXX.XXX: bytes=32 time=10ms TTL=255

If **Request timed out** appears, communication is not taking place.

- **For macOS:**

1. Start **Network Utility** as shown below.

Select **Computer** from **Go** menu of Finder, double-click **Macintosh HD > System > Library > CoreServices > Applications > Network Utility**.

2. Click **Ping**.

3. Make sure **Send only XX pings** (XX are numbers) is selected.

4. Enter IP address of target printer or target wireless router in **Enter the network address to ping**.

5. Click **Ping**.

"XXX.XXX.XXX.XXX" is the IP address of the target device.

A message such as the following appears.

64 bytes from XXX.XXX.XXX.XXX: icmp_seq=0 ttl=64 time=3.394 ms

64 bytes from XXX.XXX.XXX.XXX: icmp_seq=1 ttl=64 time=1.786 ms

64 bytes from XXX.XXX.XXX.XXX: icmp_seq=2 ttl=64 time=1.739 ms

--- XXX.XXX.XXX.XXX ping statistics ---

3 packets transmitted, 3 packets received, 0% packet loss

If "**100% packet loss**" appears, communication is not taking place. Otherwise, computer is communicating with target device.

Checking Network Setting Information

A

To check the printer's network settings information, print out the network settings information or use the operation panel to display it.

- Display on the touch screen.
 - ➔ [LAN settings](#)
- Print the network settings.
 - ➔ [Printing Network Settings](#)



Restoring to Factory Defaults



»»» Important

- Initialization erases all network settings on the printer, making printing/scanning operation from a computer over a network impossible. To use the printer over a network again after restoring it to the factory defaults, refer to Setup Guide and redo setup.
- **LCD, Remote UI, and other tools** is set as the scope for the administrator password, the administrator password must be entered.

Initialize the network setting using the printer's operation panel.

➔ [Reset settings](#)



Cannot Access to Internet on Wi-Fi from Communication Device



Check 1 Is your device connected to printer using Wireless Direct?

If your device is connected to the printer using Wireless Direct, you cannot access to the Internet. Turn off Wireless Direct and connect your device to the wireless router.

For details, see the instruction manual provided with your device and wireless router.

Check 2 Is wireless router on?

Check 3 Is wireless router configured properly?

For more on checking wireless router settings, see the instruction manual provided with the wireless router or contact its manufacturer.

Check 4 Check your device and wireless router location.

Check the distance between your device and wireless router, and check for obstruction or source of radio wave interference nearby.

Printer Problems

- **Printer Does Not Turn On**
- **USB Connection Problems**
- **Cannot Communicate with Printer via USB**
- **Touch Screen Is Off**
- **Messages advising to check the maintenance cartridge are not cleared**
- **If the Printer Makes a Strange Sound**



Printer Does Not Turn On



Check 1 Press **ON** button.

Check 2 Make sure power plug is securely connected to printer, and then turn on again.

Check 3 Unplug printer, leave it for at least 2 minutes, and then plug it back in and turn on again.

If this does not solve the problem, contact your nearest Canon service center to request a repair.

➔ [Repairing Your Printer](#)

▶▶▶ Important

- Do not tilt the printer when moving it since the ink may leak out.



USB Connection Problems



Make sure of the checking item below when you find one of the followings.

- Printing or scanning is slow.
- Hi-Speed USB connection does not work.
- A message such as "**This device can perform faster**" appears. (Windows)

▶▶▶ Note

- If your system environment does not support Hi-Speed USB, the printer operates at the slower speed of Full-Speed or Low-Speed. In this case, the printer works properly but printing or scanning speed may slow down due to the communication speed.

Check

Check following to make sure your system environment supports Hi-Speed USB connection.

- Does the USB port on your computer support Hi-Speed USB connection?
- Does the USB cable or the USB hub support Hi-Speed USB connection?

Be sure to use a certified Hi-Speed USB cable. We recommend that the USB cable be no longer than 10 feet / 3 meters or so.

- Is the Hi-Speed USB driver working properly on your computer?

Make sure the latest Hi-Speed USB driver is working properly and obtain and install the latest version of the Hi-Speed USB driver for your computer, if necessary.

▶▶▶ Important

- For more information, contact the manufacturer of your computer, USB cable, or USB hub.



Cannot Communicate with Printer via USB



Check 1 Make sure printer is turned on.

Check 2 Connect USB cable properly.

As the illustration below, the USB port is at the back of the printer.

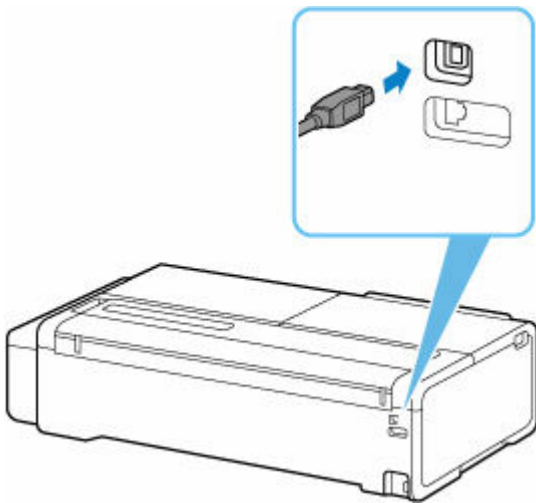

►► Important

- Check the orientation of the "Type-B" connector and connect to the printer.

Check 3 Make sure **Enable bidirectional support** is selected in the **Ports** sheet of the **Printer properties** dialog box. (Windows)

If not, select it to enable bidirectional support.

➔ [Opening Printer Driver's Setup Screen](#)



Touch Screen Is Off



- If **ON** lamp is off:

The printer is not on. Check that the power cord is connected and press the **ON** button.

- If **ON** lamp is lit:

The touch screen may be in screen-saver mode. Press any button on the operation panel.



Messages advising to check the maintenance cartridge are not cleared



The newly replaced maintenance cartridge is not recognized.

Remove the newly replaced maintenance cartridge, and then reinsert it again firmly.

➔ [Replacing the Maintenance Cartridge](#)



If the Printer Makes a Strange Sound



Check 1 Has an unusual noise been produced from the vicinity of the roll holder?

If dust accumulates on the gear (A) at the end of the roll holder, a noise may be produced from that area.

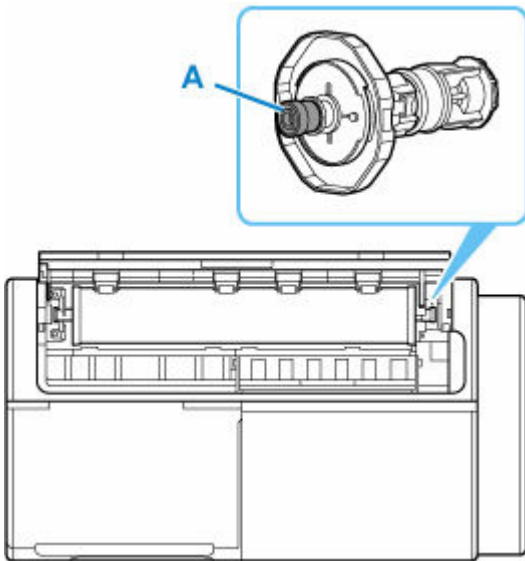

When the noise starts, clean the gear with the following procedure.

1. Remove the roll holder from the printer.
2. Wipe the dust off the gear with a damp, tightly wrung cloth, and then dry with a dry cloth.
3. Insert the roll holder in the printer.

Check 2 Operating noise may be heard from the printer even when not printing.

The following sounds do not indicate a problem with the printer.

- Roll paper makes a fluttering sound during printing.
There may be a fluttering sound when large paper is advanced.
- You suddenly hear the sound of cleaning operations.
Cleaning is automatically performed at specified intervals in order to keep the printer maintained.
- You suddenly hear the sound of ink agitation.

In other cases, contact your Canon dealer.

Printing Problems

- **Copying/Printing Stops**
- **Printer Prints Slowly**



Copying/Printing Stops



Check 1 Is paper loaded in the printer?

Make sure paper is loaded.

If necessary, load paper.

Check 2 Do documents to be printed have many photographs or illustrations?

It takes time for the printer and the computer to process large data such as photos or other graphics, so it may seem that the printer is not working.

Also, if you are printing data that requires a lot of ink on successive sheets of plain paper, the printer may pause temporarily. In either case, wait until the process is complete.

Note

- If you are printing a document with a large printing area or printing several copies, printing may pause to allow the ink to dry.

Check 3 Has printer been printing continuously for a long period?

If the printer has been printing continuously for a long time, the print head or other parts around it may overheat. The printer may stop printing at a line break for a period of time and then resume printing.

In this case, wait a while without doing anything. If the printing does not resume, turn the printer off. After waiting for a while, turn on the printer, and check whether printing is possible.

Caution

- Print head and surrounding area can become extremely hot. Never touch print head or nearby components.
-



Printer Prints Slowly



Check 1 Printer may be printing a large job from another computer.

Check 2 When using Wi-Fi, make sure the printer is not placed too far away from the wireless router.

Place the printer and wireless router where there are no obstacles between them. Wireless communication between different rooms or floors is generally poor. Wireless communication can be impeded by building materials containing metal or concrete. If the printer cannot communicate with the computer over a Wi-Fi due to a wall, place the printer and the computer in the same room.

In addition, if a device like a microwave oven that emits radio waves of the same frequency bandwidth as a wireless router is nearby, it may cause interference. Place the wireless router as far away from interference sources as possible.

Check 3 Make sure wireless signal is strong. Monitor signal status and move printer and wireless router as necessary.

Check the signal strength on the touch screen.

➔ [Home Screen Menu Composition](#)

Paper is not Fed or Ejected Properly

- **Remove Jammed Roll Paper**
- **Remove a Jammed Sheet**
- **Remove Jammed Paper (Paper Feed Slot)**
- **Roll paper cannot be inserted into the Paper Feed Slot**
- **Printer Does Not Pick up or Feed the Paper/"No Paper" Error**
- **Roll Paper Remains/Lacks under Quantity Management**
- **The printer ejects blank, unprinted paper**
- **When printing on roll paper, the printed surface becomes scratched**



Remove Jammed Roll Paper



If roll paper jams, follow the steps below to remove jams.

1. Positioning your hands as shown, open the cut sheet feed cover.

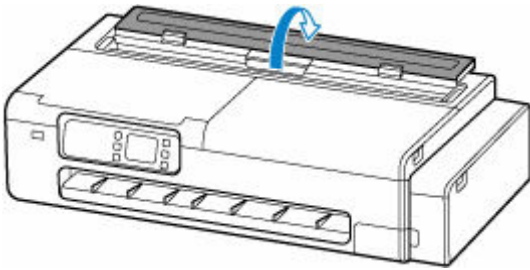

2. Open the roll paper feed cover by unlocking it with the lever in the position shown in the figure.

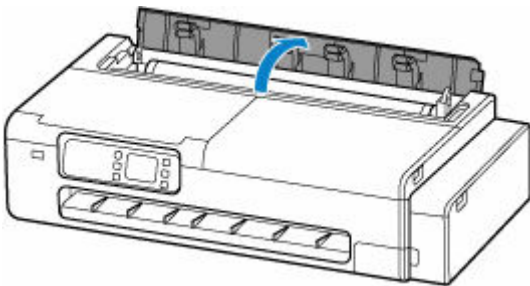

3. Cut loaded roll paper with regular scissors or the like.

Before cutting, loose the roll paper and lift it up.

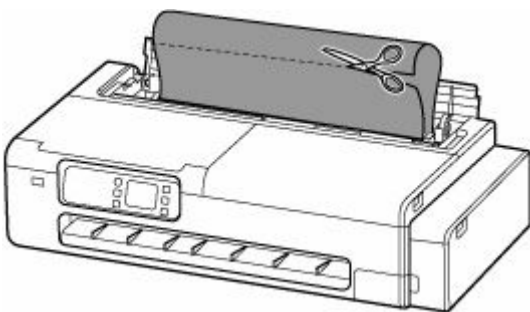

Caution

- When cutting paper, be careful to avoid injury or damage to the printer.
-

4. Open the scanning unit / cover (TC-20M only) and the access cover and move the carriage to the left or right side manually, away from the jam.

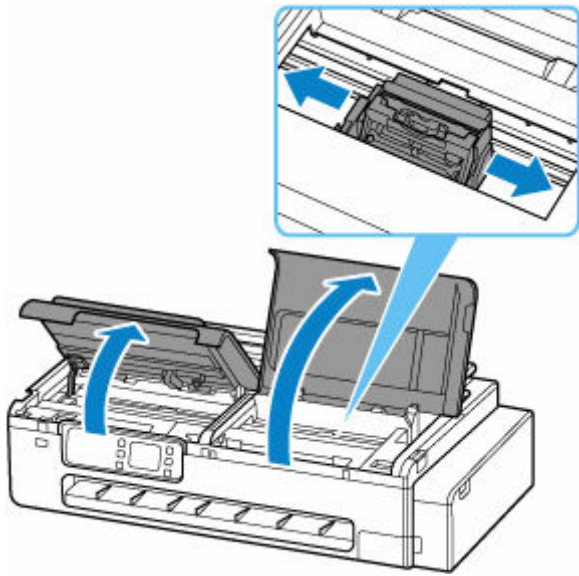

»» Important

- Do not move the carriage over jammed paper. This may damage the print head.
- Do not touch the linear scale (A) or carriage rail (B). This may stain your hands and damage the printer.

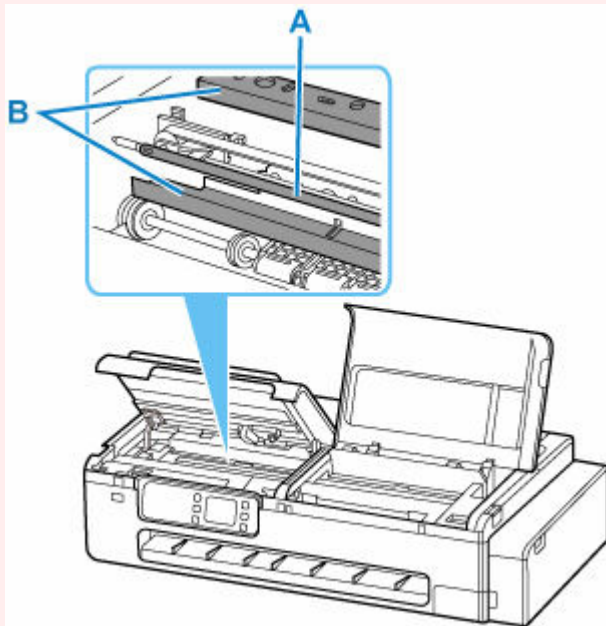

5. Remove the jammed paper from the output tray.

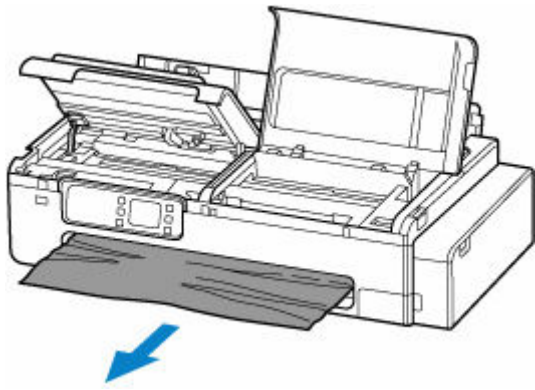

6. If there is paper left on the platen, slacken the paper on the platen and wind it up.

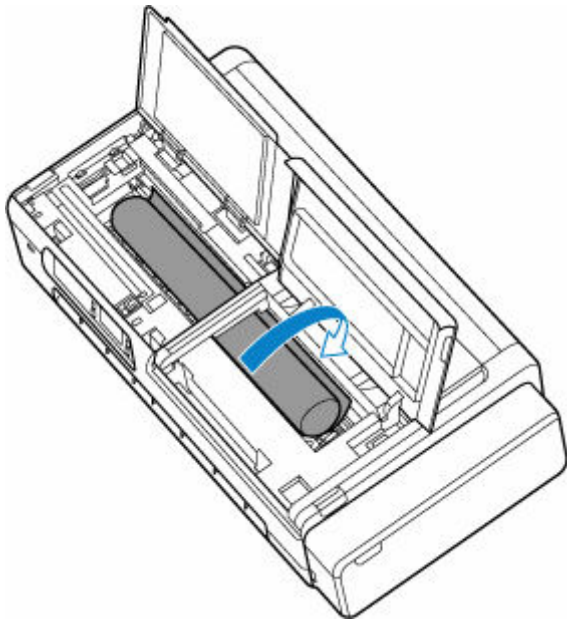

7. After rolling up all the paper, remove it from the platen.

After removing the paper from the platen, check for any remaining pieces of paper.

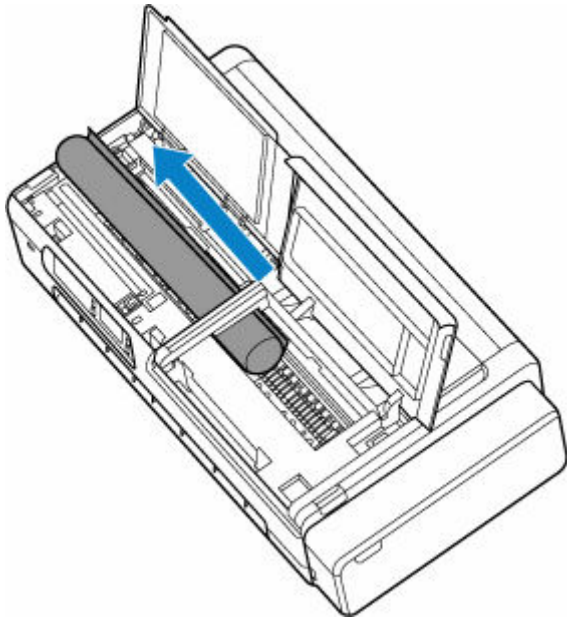

8. Close the scanning unit / cover (TC-20M only) and the access cover.

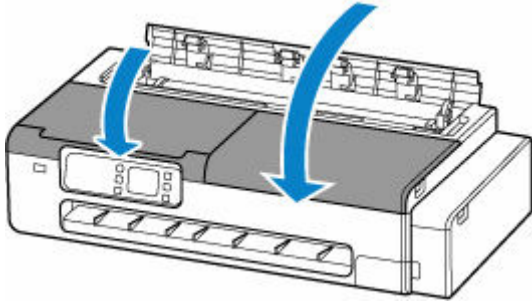

9. Close the roll paper feed cover and cut sheet feed cover.

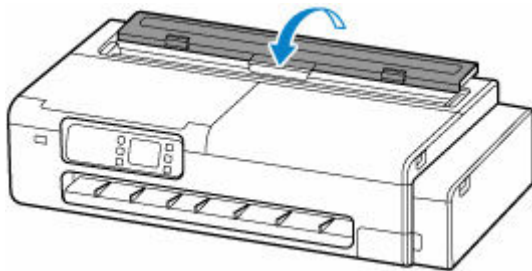



Remove a Jammed Sheet



If a sheet jams, follow the steps below to remove it.

- If the paper is jammed by the paper feed slot

Remove the jammed paper from the paper feed slot.

After removing the paper, make sure there are no other scraps of paper in the printer.

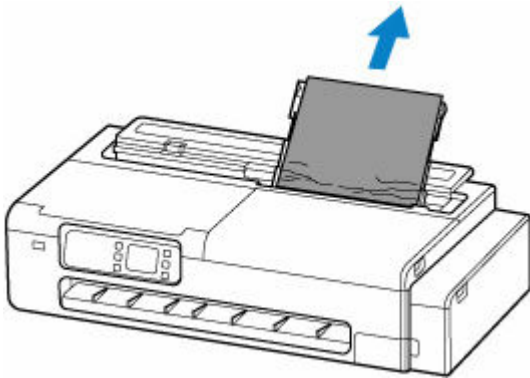

- If the paper is jammed by the ejection guide

Remove the jammed paper from the output tray.

After removing the paper, make sure there are no other scraps of paper in the printer.

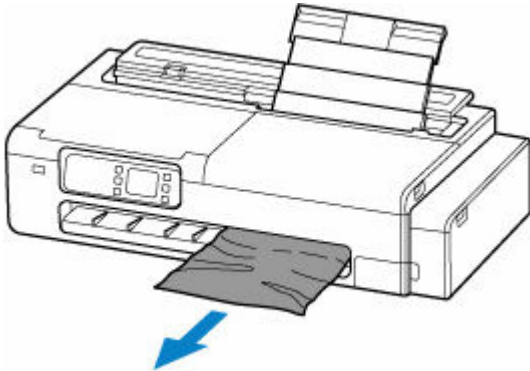

- If the paper cannot be pulled through by any of the solutions above, try the following.

1. Open the scanning unit / cover (TC-20M only) and the access cover and move the carriage to the left or right side manually, away from the jam.

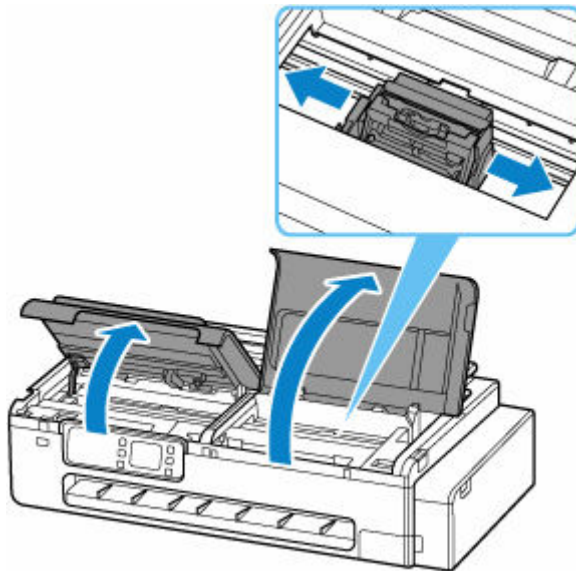

»» Important

- Do not move the carriage over jammed paper. This may damage the print head.
- Do not touch the linear scale (A) or carriage rail (B). This may stain your hands and damage the printer.

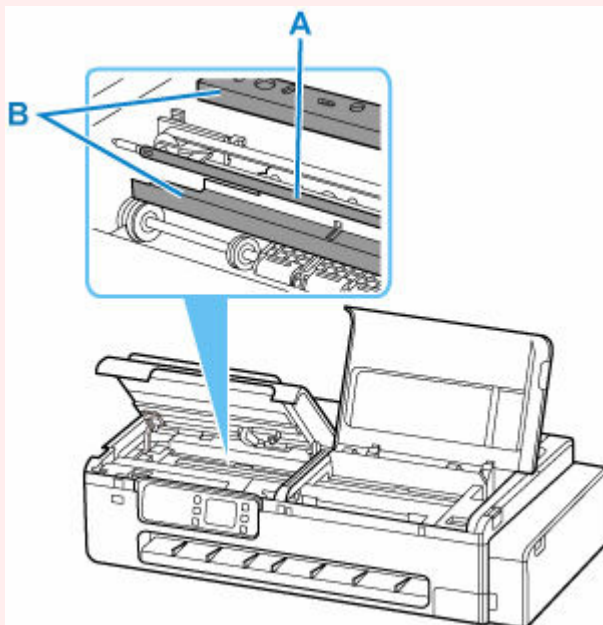

2. Remove the jammed paper from the paper feed slot and output tray again.
After removing the paper, make sure there are no other scraps of paper in the printer.
3. Close the scanning unit / cover (TC-20M only) and the access cover.

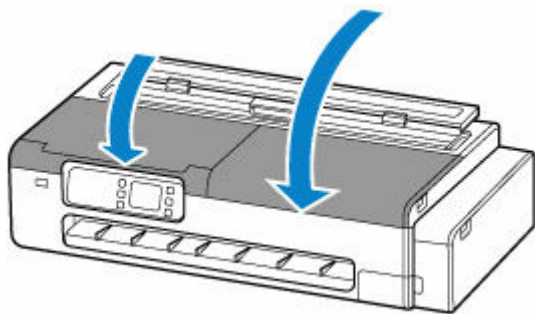

⚠ Caution

-
- When closing the scanning unit / cover, be careful not to get your fingers caught.
-



Remove Jammed Paper (Paper Feed Slot)



Follow these steps to remove any scraps left in the paper feed slot after you clear jammed sheets or roll paper.

1. Positioning your hands as shown, open the cut sheet feed cover.

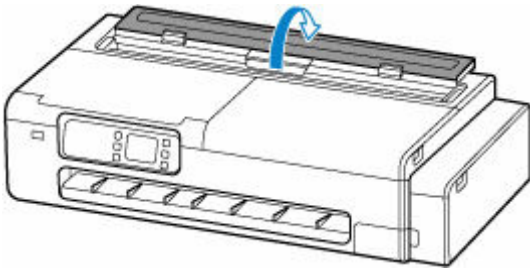

2. Open the roll paper feed cover by unlocking it with the lever in the position shown in the figure.

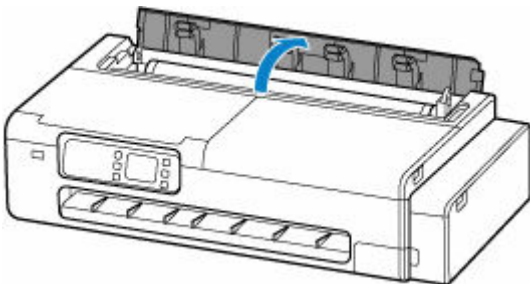

3. Fold an A4 sheet lengthwise four times, insert it through the gap of the paper feed slot, and scrape the jammed paper to the paper feed slot side.

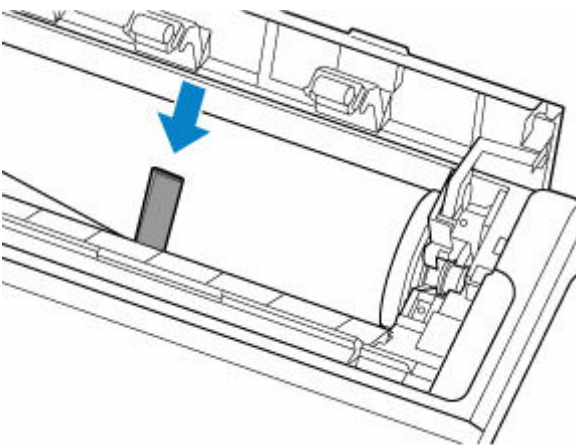

4. Remove scrap when it is pushed out onto the paper feed slot.

5. If any scraps remain inside paper feed slot, repeat steps 3 and 4.
6. Holding it at the positions indicated, close the roll paper feed cover and cut sheet feed cover.

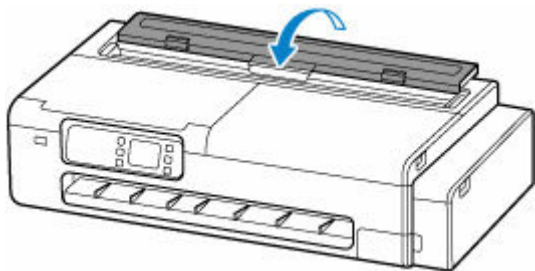



Roll paper cannot be inserted into the Paper Feed Slot



Check 1 Is the roll paper curled?

Straighten out curls and reload the roll.

Check 2 Is paper jammed in the feed slot?

Remove the jammed paper.

- ➔ [Remove Jammed Roll Paper](#)
- ➔ [Remove a Jammed Sheet](#)

Check 3 Check the paper information on the HOME screen.

Select the paper setting display area on the HOME screen of the touch screen, and if "Roll" is not displayed, select **Replace paper** or **Load roll paper** from the **Roll paper settings** screen, and then load the roll paper.

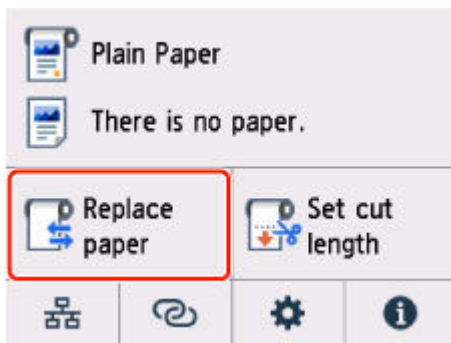

Check 4 The leading edge of the roll paper may not be cut properly.

If the leading edge of the roll paper is crooked or folded, the paper may not be fed correctly. Cut the leading edge with scissors to straighten it.

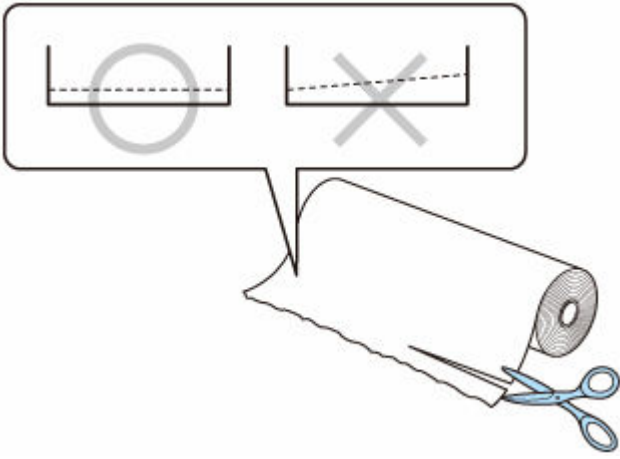



Printer Does Not Pick up or Feed the Paper/"No Paper" Error



Check 1 Make sure paper is loaded in the printer.

- ➔ [Loading Rolls in the Printer](#)
- ➔ [Loading Sheets in the Printer](#)

Check 2 When loading sheets, be sure to load the paper with the following precautions.

- When loading two or more sheets of paper, align the edges of the sheets before loading the paper.
- When loading two or more sheets of paper, make sure the paper stack does not exceed the paper load limit.

However, paper may not feed correctly at the maximum capacity, depending on the type of paper or environmental conditions (very high or low temperature and humidity). In such cases, reduce the amount of paper you load at a time to less than half of the paper load limit.

- Always load the paper in portrait orientation, regardless of the printing orientation.
- When you load the paper on the top feed, place the print side facing UP and align the right and left paper guides with the paper stack.

➔ [Loading Sheets in the Printer](#)

Check 3 Is paper too thick or curled?

Check 4 Make sure media type and paper size settings match with loaded paper.

Check 5 Make sure that there are not any foreign objects in the top feed.

Remove any foreign objects from the top feed.

If a foreign object is inside the top feed, remove it according to the following procedure.

1. Turn off the power of the printer and disconnect the power plug from the outlet.
2. Fold one A4 sheet in half and insert it horizontally into the top feed.

Insert the paper so that your hand does not directly touch the part in the center of the top feed when removing the foreign object.

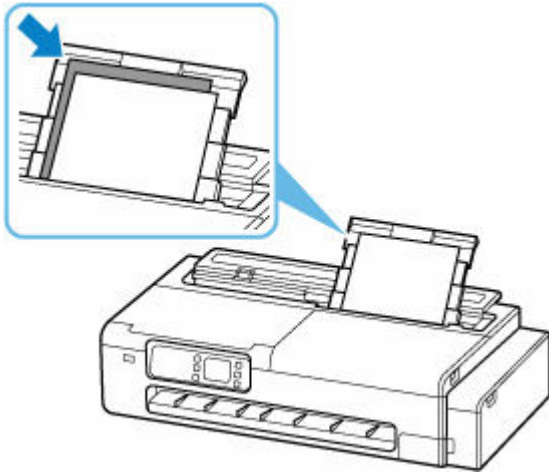

3. Remove foreign object by hand with paper inserted.

Put your hand between the paper you inserted and the top feed to remove the foreign object.

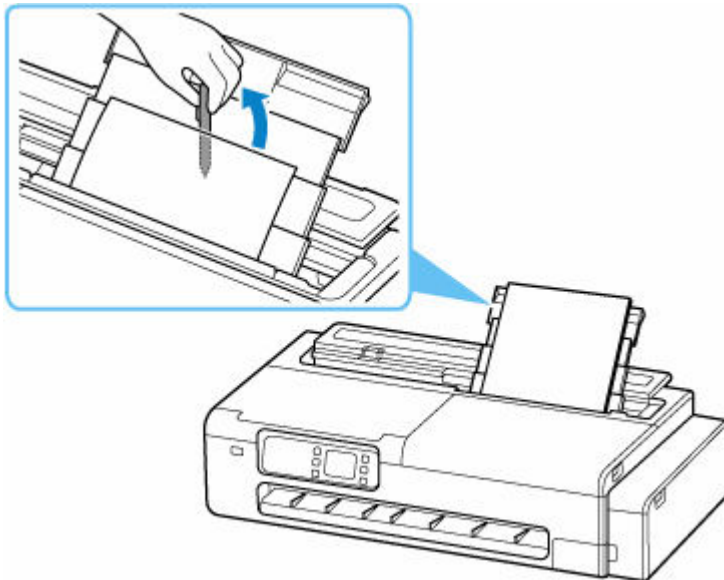

4. Remove the folded paper inserted in step 2.

Important

- Do not tilt the printer or do not it upside down. Doing so may cause the ink to leak.

Check 6 Clean Paper Feed Roller.

➔ [Cleaning Paper Feed Rollers](#)

Note

- Cleaning the paper feed roller abrades it, so do this only when necessary.



Roll Paper Remains/Lacks under Quantity Management



Check Check the setting of **Manage remaining roll amount**.

- If **Auto estimate** is selected for **Manage remaining roll amount**:

Make sure the media type is configured correctly.

Make sure **Paper core outer diameter** and **Paper thickness** are configured correctly for **Advanced paper settings**.

▶▶▶ Note

- Paper core outer diameter and Paper thickness must be set correctly for auto estimation to be accurate.
- Contact the media manufacturer for paper core outer diameter and paper thickness.
- For pre-registered paper, the paper core outer diameter and paper thickness are set, but they may be changed at the convenience of the media manufacturer.
- If you want to use paper that is not displayed in the paper information list, set the paper thickness and paper core outer diameter in the Media Configuration Tool.
 - ➔ [Media Configuration Tool Guide](#)

➔ [Paper-related settings](#)



The printer ejects blank, unprinted paper



Check 1 The leading edge of the roll paper may have been trimmed.

The leading edge of the roll paper may be trimmed if **Trim edge first** is not set to **Off** in the touch screen menu.

➔ [Cutting the Leading Edge of Roll Paper Automatically](#)

Check 2 Is the Print head nozzle blocked?

Print a nozzle check pattern to check the Print head status.

➔ [Checking for Nozzle Clogging](#)

Check 3 Is the correct printer driver selected?

Print again using the correct printer driver for your printer.

If none of the above apply, there may be a printer malfunction.

Contact your Canon dealer for assistance.



When printing on roll paper, the printed surface becomes scratched



Make sure the roll paper has not lost tension during printing.

If the roll paper loses tension, the paper surface could be damaged and the paper could wrinkle or fold.

Set **Roll paper tension (printing)** to **High** in the touch screen menu.

➔ [Advanced \(Paper settings\)](#)

▶▶▶ Note

- Carrying out **Adjust print quality** is recommended when changing **Roll paper tension (printing)** settings.

Paper Cutting Problems

- Paper is not cut straight
- Cutter Blade Does Not Work While Cutting Is in Progress
- I want to know how to configure roll cutting
- I want to configure so that the roll is cut automatically after waiting for the ink to dry



Paper is not cut straight



Check 1 Is the edge of the paper cutting position creased?

Straighten out any curling by the edges of the paper.

Check 2 Is the edge of the paper cutting position lifting up when cutting?

Reload the paper correctly.

Check 3 Are you using the basket properly?

Make sure that you are using the basket properly.

- ➔ [Using the Desktop Basket](#)
- ➔ [Using the Basket on the Printer Stand](#)

Check 4 Check that the **Cut speed** setting is correct.



Select  (Setup) > **Printer settings** > **Paper-related settings** on **Advanced paper settings** in the touch screen menu, and change **Cut speed**.

If the paper edge cannot be cut straight at the cut starting position, it may be improved by selecting slower cut speed than that selected currently.

If the paper edge cannot be cut straight at the cut ending position, it may be improved by selecting faster cut speed than that selected currently.



Select  (Setup) > **Printer settings** > **Paper-related settings** on **Advanced paper settings** in the touch screen menu, and change the **Cut speed** setting.

- ➔ [Menu Structure](#)

Check 5 Did the printing material slip diagonally while being cut?

Set the **Cutting mode** in the touch screen menu to **Eject cut**, and then hold and cut the material after it has printed.

- ➔ [Specifying the Cutting Method for Rolls](#)



Cutter Blade Does Not Work While Cutting Is in Progress



Check 1 Does a message appear on the touch screen?

If the cutter blade failed to cut the paper, it stops moving and a message appears on the touch screen.

Remove the paper and try printing again.

➔ [Remove Jammed Roll Paper](#)

Check 2 Check the setting value for **Cut speed**.

Selecting slower value may enable the cutter blade to cut paper.



Select (Setup) > **Printer settings** > **Paper-related settings** > **Advanced paper settings** on the HOME screen of the touch screen, and change the **Cut speed** setting.

➔ [Menu Structure](#)



I want to know how to configure roll cutting



Cutting methods can be selected in the printer settings.

To automatically cut roll paper after printing, open the **Cutting mode** settings on the printer.

When using paper that is easily scratched, or paper where the ink requires extra time to fix, we recommend setting **Cutting mode** on the printer to **Eject cut**.

➔ [Specifying the Cutting Method for Rolls](#)



I want to configure so that the roll is cut automatically after waiting for the ink to dry



You can set an ink drying time in the printer driver.

You can also configure the same settings on the printer itself.

➔ [Specifying the Ink Drying Time](#)

Paper Setting Problems

- **Cannot detect tracing paper size**
- **I want to know the paper types that can be used in this printer**
- **Media Type Selection does not Match Loaded Media Type**
- **The paper type that I want to print is not displayed on the Touch Screen**



Cannot detect tracing paper size



If the paper is semi-transparent paper, the size cannot be detected. **Detect paper width** setting is disabled.



I want to know the paper types that can be used in this printer



For information about paper that can be used with this printer, refer to the paper information list.

➔ [Paper Information List](#)



Media Type Selection does not Match Loaded Media Type



Check 1 Is this paper being used for the first time?

If this is the first time to use the paper, it may not be selected correctly. In the media type selection, manually select the correct paper type.

Check 2 Is the paper you set genuine paper or recommended paper?

See [Using Paper Other Than Genuine Paper and feed confirmed Paper](#)



The paper type that I want to print is not displayed on the Touch Screen



If using a new paper type, start the Media Configuration Tool to get the latest media information.

➔ [Updating paper information](#)

Ink-related Problems

- **Ink Does Not Come Out**
- **Printer consumes a lot of ink**
- **Ink Level Detection**



Ink Does Not Come Out



Check 1 Check the remaining ink level.

➔ [Checking Ink Level](#)

Check 2 Are the print head nozzles clogged?

Print the nozzle check pattern and make sure that the ink is coming out normally.

➔ [Checking for Nozzle Clogging](#)



Printer consumes a lot of ink



Check 1 Are lots of full-color materials being printed?

In print jobs such as photos, images are filled with color. This consumes a lot of ink. This does not indicate a problem with the printer.

Check 2 Is **Replace Ink in Print Head** being carried out frequently?

Performing **Replace Ink in Print Head** uses a lot of ink. This is normal. We recommend that you only carry out **Replace Ink in Print Head** after the printer has been transported, if it has not been used for a long time, or if there is a problem with the Print head.

Check 3 You have just finished initial installation, when more ink is consumed to fill the system.

If using the printer for the first time, or using it after transport, the ink tank will supply an initial fill of ink to the Print head.

Although the amount of remaining ink may drop as a result, it does not indicate a problem.

Check 4 Is the Print head nozzle blocked?

Check for nozzle clogging.

➔ [Checking for Nozzle Clogging](#)



Ink Level Detection



The printer ink tank detects the amount of ink remaining to prevent running out of ink while printing and to avoid printer failure.

➔ [Checking Ink Level](#)

About Print Settings

- **How do I print without borders**
- **I want to easily create vertical or horizontal banners**
- **Can I perform duplex printing**
- **I want to perform enlargement printing**



How do I print without borders



This printer does not support borderless printing.



I want to easily create vertical or horizontal banners



You can print originals that are in landscape (or portrait) orientation automatically enlarged to fit the roll width. This is an easy way to create vertical or horizontal banners.

- ➔ [Printing Hanging and Horizontal Banners \(Large-Format Printing\)](#) (Windows)
- ➔ [Printing Hanging and Horizontal Banners \(Large-Format Printing\)](#) (macOS)



Can I perform duplex printing



This printer cannot print double-sided.

An alternative to double-sided printing is to use the **Folded Duplex** function of the Windows software Free Layout plus, which prints two pages on one side, folds the sheet back from the center, and hangs it.

➔ [Laying Out Documents Freely Using Free Layout plus](#)



I want to perform enlargement printing



Use the printer driver to adjust the original to the paper size and width, or print enlarged or reduced by specifying a magnification factor.

- ➔ [Performing Enlarged/Reduced Printing](#) (Windows)
- ➔ [Performing Enlarged/Reduced Printing](#) (macOS)

Scanning Problems (Windows)

- [Scanning Problems](#)

Scanning Problems

- **Scanner Does Not Work**
- **ScanGear (Scanner Driver) Does Not Start**



Scanner Does Not Work



Check 1 Make sure that your scanner or printer is turned on.

Check 2 Check for any printer errors.

For messages, see When Error Occurred.

Check 3 Connect the USB cable to a different USB port on the computer.

Check 4 If the USB cable is connected to a USB hub, remove it from the USB hub and connect it to a USB port on the computer.

Check 5 With network connection, check the connection status and reconnect as needed.

➔ [Network Scan Settings](#)

Check 6 Restart the computer.

Check 7 Reinstall MP Drivers from the Setup CD-ROM or our website.



ScanGear (Scanner Driver) Does Not Start



Check 1 Make sure MP Drivers is installed.

If not installed, install MP Drivers from the Setup CD-ROM or our website.

Check 2 Select your scanner or printer on the application's menu.

▶▶▶ Important

- If your scanner or printer name is displayed multiple times, select the one that does not include WIA.

▶▶▶ Note

- The operation may differ depending on the application.
- Use the WIA driver when scanning from a WIA-compliant application.

➔ [Scanning with WIA Driver](#)

Check 3 Make sure that the application supports TWAIN.

You cannot start ScanGear (scanner driver) from applications not supporting TWAIN.

Check 4 Scan and save images with IJ Scan Utility and open the files in your application.



Error Message Appears and the ScanGear (Scanner Driver) Screen Does Not Appear



Check 1 Make sure that your scanner or printer is turned on.

Check 2 Turn off your scanner or printer, then reconnect the USB cable and replug the power cord.

Check 3 Connect the USB cable to a different USB port on the computer.

Check 4 If the USB cable is connected to a USB hub, remove it from the USB hub and connect it to a USB port on the computer.

Check 5 With network connection, check the connection status and reconnect as needed.

Check 6 Make sure MP Drivers is installed.

If not installed, install MP Drivers from the Setup CD-ROM or our website.

Check 7 Select your scanner or printer on the application's menu.

▶▶▶ Note

- The operation may differ depending on the application.

Check 8 Make sure that the application supports TWAIN.

You cannot start ScanGear (scanner driver) from applications not supporting TWAIN.

Check 9 If ScanGear is running on another application, exit ScanGear.



Cannot Scan Multiple Originals at One Time



Check 1 Make sure that the items are placed correctly.

→ [Positioning Originals \(Scanning from Computer\)](#)

Check 2 Check if you can properly scan one item.

Some applications do not support multiple image scanning. In that case, scan each item individually.



Cannot Scan Properly with Auto Scan



Check 1 Make sure that the items are placed correctly.

→ [Positioning Originals \(Scanning from Computer\)](#)

Check 2 Multiple item scanning may not be supported.

Some applications do not support multiple image scanning. In that case, scan each item individually.



Slow Scanning Speed



Check 1 To view the image on a monitor, set the output resolution to around 150 dpi. To print, set it to around 300 dpi.

➔ [Resolution](#)

Check 2 Set **Fading Correction**, **Grain Correction**, etc. to **None**.

Refer to "[Image Settings](#)" for details.

Check 3 In IJ Scan Utility, deselect the **Correct slanted text originals / Detect the orientation of text original and rotate image** checkbox, and then scan again.

➔ [Settings \(Scanning from a Computer\) Dialog Box](#)



"There is not enough memory." Message Is Displayed



Check 1 Exit other applications and try again.

Check 2 Reduce the resolution or output size and scan again.

➔ [Resolution](#)



Computer Stops Operating during Scanning



Check 1 Restart the computer, reduce the output resolution in ScanGear (scanner driver) and scan again.

Refer to "[Output Settings](#)" for details.

Check 2 Delete unnecessary files to obtain sufficient free hard disk space, then scan again.

Error message may appear if there is not enough hard disk space to scan and save, when the image size is too large (such as when scanning a large item at high resolution).

Check 3 Multiple devices may be connected to USB ports.

Disconnect devices other than your scanner or printer.

Check 4 In **Folder to Save Temporary Files** of IJ Scan Utility, specify a folder on a drive with sufficient free space.

➔ [Settings \(General Settings\) Dialog Box](#)



Scanner Does Not Work after Upgrading Windows



Check Disconnect the USB cable, then uninstall (delete) and reinstall MP Drivers and IJ Scan Utility.

Step 1: Uninstall MP Drivers.

For how to delete MP Drivers, see [Deleting the Unnecessary MP Drivers](#).

Step 2: Uninstall IJ Scan Utility.

1. From **Control Panel**, click **Programs > Programs and Features**.
2. Select **Canon IJ Scan Utility** and click **Uninstall/Change**.
3. When a confirmation appears, click **Yes**.
4. When uninstallation is complete, click **OK**.

IJ Scan Utility is deleted.

Note

- A confirmation or warning dialog box may appear when installing, uninstalling, or starting up software. This dialog box appears when administrative rights are required to perform a task. If you are logged on to an administrator account, follow the on-screen instructions.

Step 3: Reinstall MP Drivers and IJ Scan Utility.

Reinstall MP Drivers and IJ Scan Utility from the Setup CD-ROM or our website.



Scanned Image Does Not Open



Check If the data format is not supported by the application, scan the image again and select a popular data format such as JPEG when saving it.

Refer to the application's manual for details. If you have any questions, contact the manufacturer of the application.

Scan Results Are Unsatisfactory

- **Moire Appears in Scan Results**
- **Scan Quality (Image Displayed on the Monitor) Is Poor**
- **Scanned Image Is Surrounded by Extra White Areas**
- **Cannot Scan at the Correct Size**
- **Position or Size of the Image Cannot be Detected Correctly When Scanning from the Operation Panel**
- **Original Is Placed Correctly, but the Scanned Image Is Slanted**
- **Scanned Image Is Enlarged (Reduced) on the Computer Monitor**
- **Unwanted Streaks Appear in Scan Results after Scanning from ADF (Auto Document Feeder)**



Moire Appears in Scan Results



Check 1 Increase the scanning resolution.

➔ [Resolution](#)

Check 2 Take the following measures and scan again.

- Set one of the following settings in the **Settings (Document Scan)** dialog box, **Settings (Custom Scan)** dialog box, **Settings (Scan and Stitch)** dialog box, **Settings (OCR)** dialog box or **Settings (E-mail)** dialog box of IJ Scan Utility, then scan from the IJ Scan Utility main screen.
 - Set **Source Type** to **Magazine** and set **Color Mode** to **Color**
 - Select the **Reduce moire** checkbox in **Image Processing Settings**
- ➔ [Settings \(Scanning from a Computer\) Dialog Box](#)
- On the **Basic Mode** tab of ScanGear (scanner driver), select **Magazine (Color)** in **Select Source**.
Refer to "[Basic Mode Tab](#)" for details.
- On the **Advanced Mode** tab of ScanGear, set **Descreen** in **Image Settings** to **ON**.
Refer to "[Image Settings](#)" for details.

▶▶▶ Note

- If moire appears when you scan a digital print photo, take the above measures and scan again.



Scan Quality (Image Displayed on the Monitor) Is Poor



Check 1 If the image is jagged, increase the scanning resolution, or select **TIFF** or **PNG** in **Data Format** of the Settings dialog box.

- ➔ [Resolution](#)
- ➔ [Settings Dialog Box](#)

Check 2 Set the display size to 100 %.

Some applications do not display images clearly if the display size is too small.

Check 3 Clean the platen and document cover.

Check 4 If moire (stripe pattern) appears, take the following measures and scan again with IJ Scan Utility.

- Set one of the following settings in the **Settings (Document Scan)** dialog box, **Settings (Custom Scan)** dialog box, or **Settings (Scan and Stitch)** dialog box of IJ Scan Utility, then scan from the IJ Scan Utility main screen.
 - Set **Source Type** to **Magazine** and set **Color Mode** to **Color**
 - Select the **Reduce moire** checkbox in **Image Processing Settings**
- ➔ [Settings \(Scanning from a Computer\) Dialog Box](#)
- On the **Basic Mode** tab of ScanGear (scanner driver), select **Magazine (Color)** in **Select Source**.
Refer to "[Basic Mode Tab](#)" for details.
- On the **Advanced Mode** tab of ScanGear, set **Descreen** in **Image Settings** to **ON**.
Refer to "[Image Settings](#)" for details.

▶▶▶ Note

- If moire appears when you scan a digital print photo, take the above measures and scan again.

Check 5 Check the monitor's color depth.

Refer to Help of Windows or the monitor's manual for details on how to check the monitor's color depth.

Check 6 If the document is in poor condition (dirty, faded, etc.), then set **Reduce Dust and Scratches**, **Fading Correction**, **Grain Correction**, etc. in **Image Settings** on the **Advanced Mode** tab of ScanGear.

Refer to "[Image Settings](#)" for details.

Check 7 If the color tone of images is different from the original document, take the following measures and scan again.

- On the **Advanced Mode** tab of ScanGear, set **Image Adjustment** in **Image Settings** to **None**.

Refer to "[Image Settings](#)" for details.

- On the **Color Settings** tab in the **Preferences** dialog box of ScanGear, set **Color Matching**.

Refer to "[Color Settings Tab](#)" for details.



Scanned Image Is Surrounded by Extra White Areas



Check Specify the scan area.



Click  (Auto Crop) in whole image view of ScanGear (scanner driver) to automatically display the cropping frame (scan area) according to the item size.

You can also manually specify the scan area in thumbnail view or when there are white margins along the item (for example, in photos), or when you want to create custom cropping frames.

➔ [Adjusting Cropping Frames in the Image Stitch Window](#)

▶▶▶ Note

- Refer to "[Adjusting Cropping Frames \(ScanGear\)](#)" for how to adjust cropping frames with ScanGear (scanner driver).



Cannot Scan at the Correct Size



Check Make sure that the items are placed correctly.

➔ [Positioning Originals \(Scanning from Computer\)](#)



Position or Size of the Image Cannot be Detected Correctly When Scanning from the Operation Panel



Check 1 Make sure that the items are placed correctly.

➔ [Positioning Originals \(Scanning from Computer\)](#)

Check 2 Check that the settings match the item to be scanned.

If you cannot scan properly by automatically detecting the item type, specify the item type and size.

When Scanning from the Operation Panel:

For the setting items when scanning from the operation panel, see [Setting Items for Scanning Using Operation Panel](#).

When Scanning with IJ Scan Utility:

➔ [Scanning Documents and Photos](#)

➔ [Scanning with Favorite Settings](#)



Original Is Placed Correctly, but the Scanned Image Is Slanted



Check When Document or **Magazine** is selected for **Source Type**, deselect the **Correct slanted text originals** checkbox and scan the item again.

➔ [Settings \(Scanning from a Computer\) Dialog Box](#)



Scanned Image Is Enlarged (Reduced) on the Computer Monitor



Check 1 Change the display setting in the application.

Refer to the application's manual for details. If you have any questions, contact the manufacturer of the application.

▶▶▶ Note

- You cannot reduce the image size in Paint. To reduce the display size, open the images in an application.

Check 2 Change the resolution setting in ScanGear (scanner driver) and scan again.

The higher the resolution, the larger the resulting image will be.

➔ [Resolution](#)



Unwanted Streaks Appear in Scan Results after Scanning from ADF (Auto Document Feeder)



Check Place the document on the platen and scan.

If unwanted streaks appear in scan results after scanning from the ADF (Auto Document Feeder), place the document on the platen and scan again.

➔ [Positioning Originals \(Scanning from Computer\)](#)

Software Problems

- **The E-mail Client You Want to Use Does Not Appear in IJ Scan Utility's Selection Screen**



The E-mail Client You Want to Use Does Not Appear in IJ Scan Utility's Selection Screen



Check Check that the e-mail client's MAPI is enabled.

Refer to the e-mail client's manual for how to set MAPI.

If the problem is not solved even when MAPI is enabled, select **None (Attach Manually)** in the screen for selecting an e-mail client, then manually attach the image to the outgoing e-mail.

IJ Scan Utility Error Messages

If an error message for IJ Scan Utility appears, check the error code and follow the corresponding solution.

Error Code	Error Message	Solution
152	There is not enough memory. Exit other applications to increase available memory.	<ul style="list-style-type: none"> The memory required to start IJ Scan Utility cannot be obtained; exit other applications.
153	The image you attempted to scan is in a size that cannot be opened in the specified application. Change the settings so that the image size is reduced.	<ul style="list-style-type: none"> Reduce the resolution or output size and scan again.
201	A required file is missing or corrupted, or settings are incorrect. Try the installation again.	<ul style="list-style-type: none"> Delete MP Drivers, then re-install MP Drivers from the Setup CD-ROM or our website. <p>For how to delete MP Drivers, see Deleting the Unnecessary MP Drivers.</p>
202	An internal error has occurred. Take the following measures. <ul style="list-style-type: none"> - Check the scanner status. - Restart the scanner. - Restart the computer, then try again. - Reinstall the scanner driver. 	<ul style="list-style-type: none"> An internal error has occurred. Take the following measures. <ul style="list-style-type: none"> ◦ Check the scanner status. ◦ Restart the scanner. ◦ Restart the computer, then try again. ◦ Reinstall MP Drivers.
230	A scanner driver supporting this software is not installed. Install it and try again.	<ul style="list-style-type: none"> Reinstall MP Drivers from the Setup CD-ROM or our website.
231	Cannot complete the scan. The disk space is insufficient.	<ul style="list-style-type: none"> Delete unnecessary files on the hard disk and scan again.
232	Cannot save the file. The disk is write-protected. Cancel the protection or use another disk.	<ul style="list-style-type: none"> Cancel the write protection on the disk.
234	This scan function is not supported by the selected model. Select a different scan function.	<ul style="list-style-type: none"> Select a different scan function.
242	Cannot write file.	<ul style="list-style-type: none"> Check the access permission on the folder in Folder to Save Temporary Files in the Settings (General Settings) dialog box or Save

		in in the corresponding Settings dialog box.
243	Cannot read file.	<ul style="list-style-type: none"> • Check the access permission on the folder in Folder to Save Temporary Files in the Settings (General Settings) dialog box or Save in in the corresponding Settings dialog box.
244	You do not have the required privileges to access the specified folder.	<ul style="list-style-type: none"> • Grant access permission to the specified folder.
245	Text could not be detected. Make sure that the following conditions do not apply. <ul style="list-style-type: none"> - The Document Language setting does not match the document language. - There is no text in the document. - Text that is not supported for detection is scanned. 	<ul style="list-style-type: none"> • Make sure the Document Language in the Settings (General Settings) dialog box matches the document language. • Make sure there is text in the document.

ScanGear (Scanner Driver) Error Messages

If an error message for ScanGear (scanner driver) appears, check the error code and follow the corresponding solution.

Error Code	Error Message	Solution
1 4 10 122 151 175 176 177	Error in scanner. Turn off scanner and follow instructions in User's Guide. Scanner driver will be closed.	<ul style="list-style-type: none"> • Make sure that your scanner or printer and the computer are connected correctly. • Delete MP Drivers, then reinstall MP Drivers from the Setup CD-ROM or our website. <p>For how to delete MP Drivers, see Deleting the Unnecessary MP Drivers.</p> <ul style="list-style-type: none"> • Your scanner or printer may be damaged. <p>Restart the computer, then reconnect your scanner or printer. If the same error message still appears, contact your nearest Canon service center.</p>
140	Printer is in use or an error has occurred. Check the printer status. Scanner driver will be closed.	<ul style="list-style-type: none"> • If you are attempting to SCAN while the printer is performing another operation (for example, printing), please wait for that operation to finish before attempting to SCAN. • If you are attempting to SCAN while a support code is displayed by the printer, you must address and resolve that support code before you can continue to SCAN. <p>For example, a 1688 support code signifies that the printer has detected that one or more of your ink cartridges is empty. You must follow the instructions to resolve the 1688 support code to continue to SCAN.</p> <p>For example, a 1640 support code signifies that the printer has detected that the remaining ink in one or more of the ink tanks may have reached the lower limit line shown on the ink tank, and you must follow the instructions to resolve the 1640 support code to continue to SCAN.</p> <ul style="list-style-type: none"> • Please follow the instructions on the page entitled When Error Occurred

		to address and resolve the particular support code displayed by the printer.
145	<p>Cannot communicate with scanner for these reasons:</p> <ul style="list-style-type: none"> - Scanner is turned off. - Scanner is disconnected. <p>(It is disconnected from LAN, if using on LAN.)</p> <p>Please check and try again. Scanner driver will be closed.</p>	<ul style="list-style-type: none"> • Make sure that your scanner or printer is turned on. • Delete MP Drivers, then reinstall MP Drivers from the Setup CD-ROM or our website. <p>For how to delete MP Drivers, see Deleting the Unnecessary MP Drivers.</p>
155	<p>Cannot communicate with scanner.</p> <p>Cable may be disconnected or scanner may be turned off.</p> <p>Check status.</p> <p>Scanner driver will be closed.</p>	<ul style="list-style-type: none"> • Make sure that the selected application source is correct. Refer to the application's manual for details. • Check the printer status.
156	<p>Cannot communicate with scanner for these reasons:</p> <ul style="list-style-type: none"> - Scanner is turned off. - USB cable is disconnected. <p>Please check and try again.</p> <p>Scanner driver will be closed.</p>	<ul style="list-style-type: none"> • With USB connection, check the connection of the USB cable and reconnect as required. • With network connection, check the connection status and reconnect as needed.
157	<p>Cannot communicate with scanner for these reasons:</p> <ul style="list-style-type: none"> - Scanner is turned off. - (If using Wired LAN connection) It is disconnected from Wired LAN. - (If using wireless LAN connection) Signal strength is poor due to obstructions. - Network connection is prohibited by security software. - Different scanner on the network is selected. <p>Please check and try again.</p> <p>Click [Scanner Selection] if you want to select another scanner.</p> <p>Scanner driver will be closed.</p>	<ul style="list-style-type: none"> • With network connection, specify the scanner to use with IJ Network Scanner Selector EX. <p>Refer to "Network Scan Settings" for the setting procedure.</p>
152	<p>Running out of memory.</p> <p>Increase available memory.</p> <p>Scanner driver will be closed.</p>	<ul style="list-style-type: none"> • The memory required to start ScanGear (scanner driver) cannot be obtained; exit other applications.
201	<p>A required file is missing or corrupted, or settings are incorrect.</p> <p>Try the installation again.</p> <p>Scanner driver will be closed.</p>	<ul style="list-style-type: none"> • Delete MP Drivers, then reinstall MP Drivers from the Setup CD-ROM or our website. <p>For how to delete MP Drivers, see Deleting the Unnecessary MP Drivers.</p>
202	<p>An internal error has occurred.</p> <p>Scanner driver will be closed. Take the following measures.</p> <ul style="list-style-type: none"> - Check the scanner status. - Restart the scanner. 	<ul style="list-style-type: none"> • An internal error has occurred. Take the following measures. <ul style="list-style-type: none"> ◦ Check the scanner status. ◦ Restart the scanner.

	<ul style="list-style-type: none"> - Restart the computer, then try again. - Reinstall the scanner driver. 	<ul style="list-style-type: none"> ◦ Restart the computer, then try again. ◦ Reinstall MP Drivers. • Click Control Panel > System and Security > Administrative Tools, and then double-click Services to check if WIA (Windows Image Acquisition) is running or in started state. • There may be interference with other drivers; delete unnecessary drivers. • Your application may not properly comply with TWAIN. Scan using another application.
203	<p>There is not enough free disk space to complete the scan. Scanner driver will be closed.</p>	<ul style="list-style-type: none"> • Delete unnecessary files on the hard disk and scan again.
206	<p>The scanner is not available while in use by another application or user.</p>	<ul style="list-style-type: none"> • Exit the ScanGear in use.
207	<p>Scanner is not selected. Click [Scanner Selection] to select scanner. Scanner driver will be closed.</p>	<ul style="list-style-type: none"> • With network connection, specify the scanner to use with IJ Network Scanner Selector EX. Refer to "Network Scan Settings" for the setting procedure.
208	<p>IJ Network Scanner Selector cannot be found. Reinstall scanner driver. Scanner driver will be closed.</p>	<ul style="list-style-type: none"> • Delete MP Drivers, then reinstall MP Drivers from the Setup CD-ROM or our website. For how to delete MP Drivers, see Deleting the Unnecessary MP Drivers.
250	<p>An error has occurred. Turn the device off and then back on. Scanner driver will be closed.</p>	<ul style="list-style-type: none"> • Turn the device off and then back on.
252	<p>Cannot write or read file.</p>	<ul style="list-style-type: none"> • Exit running applications, check that there is sufficient free space on the hard disk, then scan again.

List of Support Code for Error

Support code appears on the printer's touch screen and your computer screen when errors occur.

A "support code" is an error number, and appears along with an error message.

When an error occurs, check the support code and take the appropriate action in response.

Support Code Appears on Printer's Touch Screen and Computer Screen

- **1000 to 1ZZZ**

[1000](#) [100A](#) [1021](#) [1024](#) [1026](#) [1058](#)

[1070](#) [1200](#) [1201](#) [120A](#) [120B](#) [1215](#)

[1220](#) [1221](#) [1300](#) [1313](#) [1317](#) [1369](#)

[136A](#) [136B](#) [1401](#) [1403](#) [1405](#) [140B](#)

[1434](#) [147D](#) [1496](#) [1563](#) [15A1](#) [15A2](#)

[15A3](#) [15B0](#) [1643](#) [1723](#) [1724](#) [1725](#)

[1726](#) [1727](#)

- **2000 to 2ZZZ**

[2001](#) [2002](#) [2114](#) [2117](#) [2123](#) [2200](#)

[2500](#) [2700](#)

- **3000 to 3ZZZ**

[3000](#) [3252](#) [3306](#) [3310](#) [3311](#) [3312](#)

[3313](#) [3314](#) [3315](#) [3316](#) [3317](#) [3318](#)

[3319](#) [3401](#) [3405](#) [3407](#) [3408](#) [3412](#)

[3413](#) [3414](#) [3415](#) [3416](#) [3417](#) [3418](#)

[3419](#) [3420](#) [3421](#) [3422](#) [3423](#) [3424](#)

[3425](#) [3438](#) [3440](#) [3441](#) [3442](#) [3443](#)

[3444](#) [3445](#) [3446](#) [3447](#)

- **4000 to 4ZZZ**

[4103](#) [4104](#) [4111](#) [4920](#) [4931](#) [495A](#)

• **5000 to 5ZZZ**

[5011](#) [5012](#) [5050](#) [5100](#) [5108](#) [5200](#)

[5207](#) [5700](#) [5C02](#) [5C30](#)

• **6000 to 6ZZZ**

[6000](#) [6001](#) [6004](#) [6011](#) [6012](#) [6013](#)

[6014](#) [6015](#) [6016](#) [6017](#) [6018](#) [6019](#)

[6030](#) [6500](#) [6503](#) [6700](#) [6701](#) [6800](#)

[6801](#) [6830](#) [6831](#) [6832](#) [6833](#) [6900](#)

[6901](#) [6902](#) [6910](#) [6920](#) [6921](#) [6930](#)

[6931](#) [6932](#) [6933](#) [6936](#) [6937](#) [6938](#)

[6940](#) [6941](#) [6942](#) [6943](#) [6944](#) [6945](#)

[6946](#) [6A80](#) [6A81](#) [6D01](#)

• **7000 to 7ZZZ**

[7500](#) [7600](#) [7700](#) [7800](#)

• **8000 to 8ZZZ**

[8200](#)

• **9000 to 9ZZZ**

[9000](#)

• **A000 to ZZZZ**

[B506](#) [B508](#) [B509](#) [B50A](#) [C000](#) [D103](#)

[D107](#) [D108](#) [D109](#)

Cause

Possible causes include the following.

- There is no paper in the top feed.
- Paper is not loaded in the top feed properly.

What to Do

Take the corresponding actions below.

- Load paper in the top feed.
 - ➔ [Loading Sheets in the Printer](#)
- Align the paper guides of the top feed with both edges of the paper.

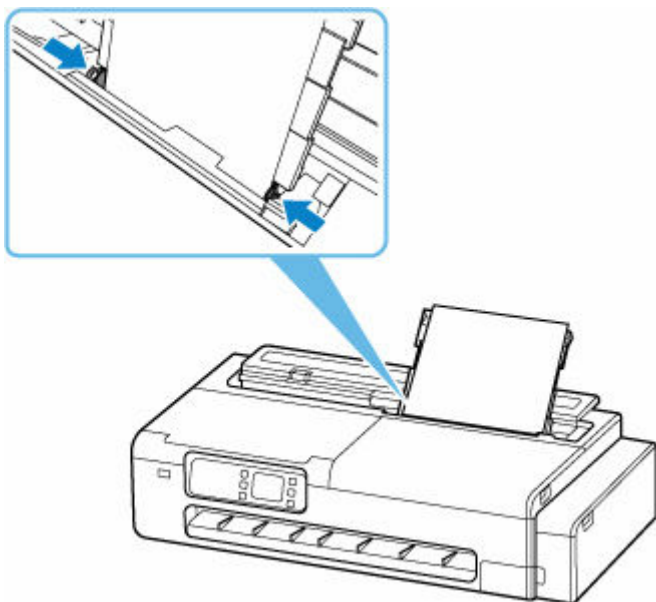

After carrying out the above measures, select **OK** on the printer's touch screen to cancel the error.

▶▶▶ Note

- To cancel printing, press the printer's **Stop** button.

100A

Cause

You have attempted to print on a roll, but no roll is loaded.

What to Do

Tap **Load roll paper** on the touch screen, and then load the paper roll and print.

➔ [Loading Rolls in the Printer](#)

▶▶ Note

- To cancel printing, press the printer's **Stop** button.

1021

Cause

The printer has received a print job longer than the amount of roll paper left.

What to Do

Tap **Replace paper** on the printer's touch screen, replace the paper roll with a paper roll that is long enough to print the print job and continue printing.

➔ [Removing the Roll from the Printer](#)

➔ [Loading Rolls in the Printer](#)

➤➤ Note

- To cancel printing, press the printer's **Stop** button.

Cause

Possible causes include the following.

- Roll paper is empty.
- There is remaining roll paper, but because it could not be advanced, it could not be detected.

What to Do

• The roll paper has run out

Follow the steps below to replace the used roll with a new roll of the same type and size.

1. Remove the roll paper.

➔ [Removing the Roll from the Printer](#)

2. Load the new roll.

➔ [Loading Rolls in the Printer](#)

• Feed stopped because the end of the paper roll is attached to the core with tape

Remove the used roll paper and insert a new roll paper.

➔ [Removing the Roll from the Printer](#)

➔ [Loading Rolls in the Printer](#)

• Feed stopped because the remaining paper roll is too heavy

It may be helpful to change the printing mode, which will change the paper feed timing.

If using Windows, select a higher **Print Quality** setting under **Advanced Settings** in the printer driver.

If using macOS, select **Quality & Media** in the printer driver, and then select a higher **Print Quality** setting.

➔ [Setting the Print Quality Level \(Custom\)](#) (Windows)

➔ [Setting the Print Quality Level \(Custom\)](#) (macOS)

▶▶▶ Note

- To cancel printing, press the printer's **Stop** button.

Cause

Roll paper is empty.

What to Do

- **The roll paper has run out**

Follow the steps below to replace the used roll with a new roll of the same type and size.

1. Remove the roll paper.

- ➔ [Removing the Roll from the Printer](#)

2. Load the new roll.

- ➔ [Loading Rolls in the Printer](#)

Printing will resume, starting from the page on which the error occurred.

- **Feed stopped because the end of the paper roll is attached to the core with tape**

Remove the used roll paper and insert a new roll paper.

- ➔ [Removing the Roll from the Printer](#)

- ➔ [Loading Rolls in the Printer](#)

▶▶▶ Note

- To cancel printing, press the printer's **Stop** button.

1058

Cause

Roll paper has almost run out.

What to Do

Printing will continue. Replace the roll paper in the printer with one that has enough paper for printing as soon as possible.

➔ [Removing the Roll from the Printer](#)

➔ [Loading Rolls in the Printer](#)

➤➤ Note

- To cancel printing, press the printer's **Stop** button.

1070

Cause

Paper cannot be fed because the paper feed rollers are dirty.

What to Do

Press the printer's **Stop** button to cancel printing.

Then perform the paper feed roller cleaning of top feed.

- From the printer's operation panel:

➔ [Cleaning Paper Feed Rollers](#)

1200

Cause

Access cover is open.

What to Do

Close the access cover and wait for a while.

1201

Cause

The ink tank cover is open.

What to Do

Close the ink tank cover.

120A

Cause

The scanning unit / cover (TC-20M) or the access cover on the left (TC-20) is opened.

What to Do

Close the scanning unit / cover (TC-20M) or the access cover on the left (TC-20), and wait for a while.

120B

Cause

The roll paper feed cover is open.

What to Do

Close the roll paper feed cover.

1215

Cause

Printer maintenance in progress.

What to Do

Complete printer maintenance.

1220

Cause

Roll paper feed cover is open.

What to Do

Close the roll paper feed cover, select **OK** on the printer's touch screen to cancel the error.

➔ [Front](#)

1221

Cause

Roll paper feed cover is open.

What to Do

Close the roll paper feed cover, select **OK** on the printer's touch screen to cancel the error.

➔ [Front](#)

Cause

Possible causes include the following.

- Paper is jammed.
- The Lock lever of the roll holder is not locked.

What to Do

1. Remove jammed paper.

- ➔ [Remove Jammed Roll Paper](#)
- ➔ [Remove a Jammed Sheet](#)

▶▶▶ Note

- If you cannot pull out the paper, turn the printer back on without pulling forcibly. The paper may be ejected automatically.
 - If paper becomes jammed during printing and you need to turn off the printer to remove it, press the printer's **Stop** button to stop the printing before you turn off the printer.
 - If the paper tears and you cannot remove the jammed paper from the paper output slot or the top feed, remove the paper from inside the printer.
- ➔ [Remove Jammed Paper \(Paper Feed Slot\)](#)

2. Lock the lock lever of the roll holder.

When roll paper is loaded, remove the roll paper from the printer, and check if the lock lever of the roll holder is locked.

- ➔ [Removing the Roll from the Printer](#)

3. Reload paper and select **OK** on printer's touch screen.

The printer resumes printing. Reprint the page you were printing if it was not printed properly due to the paper jam.

If you turned off the printer in step 1, all jobs in the print queue are canceled. Redo the printing.

▶▶▶ Note

- When reloading the paper, make sure you are using suitable paper and loading it correctly.
- We recommend using paper sizes other than A5 to print documents with photos or graphics. A5 paper may curl and jam as it leaves the printer.

If the measures above do not solve the problem, contact your nearest Canon service center to request a repair.

▶▶▶ Important

- Do not tilt the printer when moving it since the ink may leak out.

- When transporting the printer for repairing it, see [Repairing Your Printer](#).

Cause

Paper is jammed as printer pulled in printed paper.

What to Do

Depending on where the paper is jammed, decide on the countermeasure.

- If the paper is jammed at the paper output slot:
 - ➔ [Remove Jammed Roll Paper](#)
 - ➔ [Remove a Jammed Sheet](#)
- If the paper is jammed inside the printer:
 - ➔ [Remove Jammed Paper \(Paper Feed Slot\)](#)

Cause

Paper loaded crooked was detected when the paper was advanced.

What to Do

Reload the paper.

- ➔ [Loading Rolls in the Printer](#)
- ➔ [Loading Sheets in the Printer](#)

If this error appears again even after reloading the paper roll, reinsert the roll holder so that there is no gap between it and the paper roll.

- ➔ [Loading Rolls in the Printer](#)

▶▶▶ Important

- If this message continues to appear even after taking the steps above, or if you do not want this message to appear, set **Skew detection accuracy** in the printer menu to **OFF** or **Loose**. However, note that the paper will be printed skewed, which could cause paper jams and abnormal print results, or dirty the platen and the reverse of the next printed sheet.

1369

Cause

There is insufficient ink to perform cleaning.

What to Do

Select **OK** on the printer's touch screen to cancel the error.

Before performing cleaning, check the remaining ink level of all colors, and refill the ink as necessary.

➔ [Checking Ink Level](#)

➔ [Refilling Ink Tanks](#)

▶▶ Note

- Since replace ink in print head consumes a lot of ink, perform it only when necessary.

136A

Cause

Cleaning cannot be performed because the maintenance cartridge is almost full.

What to Do

To perform cleaning, replace the maintenance cartridge.

➔ [Replacing the Maintenance Cartridge](#)

Tap the printer's **OK** button.

136B

Cause

Print head cleaning was executed continuously.

What to Do

Tap **OK** on the printer's touch screen.

If cleaning is to be performed continuously, allow a certain amount of time after the previous cleaning.

1401

Cause

Print head may be damaged.

What to Do

Turn off the printer and turn it back on.

If this does not solve the problem, contact your nearest Canon service center to request a repair.

»» Important

- Do not tilt the printer when moving it since the ink may leak out.
- When transporting the printer for repairing it, see [Repairing Your Printer](#).

1403

Cause

Print head may be damaged.

What to Do

Turn off the printer and turn it back on.

If this does not solve the problem, contact your nearest Canon service center to request a repair.

»» Important

- Do not tilt the printer when moving it since the ink may leak out.
- When transporting the printer for repairing it, see [Repairing Your Printer](#).

1405

Cause

Print head may be damaged.

What to Do

Turn off the printer and turn it back on.

If this does not solve the problem, contact your nearest Canon service center to request a repair.

»» Important

- Do not tilt the printer when moving it since the ink may leak out.
- When transporting the printer for repairing it, see [Repairing Your Printer](#).

140B

Cause

Print head may be damaged.

What to Do

Turn off the printer and turn it back on.

If this does not solve the problem, contact your nearest Canon service center to request a repair.

»» Important

- Do not tilt the printer when moving it since the ink may leak out.
- When transporting the printer for repairing it, see [Repairing Your Printer](#).

1434

Cause

Print head may be damaged.

What to Do

Turn off the printer and turn it back on.

If this does not solve the problem, contact your nearest Canon service center to request a repair.

»» Important

- Do not tilt the printer when moving it since the ink may leak out.
- When transporting the printer for repairing it, see [Repairing Your Printer](#).

147D

Cause

Print head may be damaged.

What to Do

Turn off the printer and turn it back on.

If this does not solve the problem, contact your nearest Canon service center to request a repair.

»» Important

- Do not tilt the printer when moving it since the ink may leak out.
- When transporting the printer for repairing it, see [Repairing Your Printer](#).

1496

Cause

The maintenance cartridge cannot be recognized.

The maintenance cartridge may not be installed properly or may not be compatible with this printer.

What to Do

Remove the maintenance cartridge, and then reinstall it correctly.

Refer to [Replacing the Maintenance Cartridge](#) for details on removing and installing the maintenance cartridge.

1563

Cause

There may not be enough ink left.

What to Do

Check the remaining ink level and refill with the ink of the color that is running low.

➔ [Checking Ink Level](#)

15A1

Cause

Printer operation is not completed.

What to Do

Proceed with printer setup according to the message displayed on the printer's touch screen.

If this error occurs while operating the printer from a smartphone / tablet, complete the printer setup and then operate again.

15A2

Cause

There is no ink in the ink tanks.

What to Do

Fill the ink tanks with all the ink contained in the bottles included with the printer.

➔ [Refilling Ink Tanks](#)

After filling the ink, close the tank caps and ink tank inner covers firmly and close the ink tank cover.

15A3

Cause

Shipping tape or protective material may still be attached to carriage.

What to Do

Open the scanning unit / cover (TC-20M only) and the access cover and make sure that shipping tape and protective material have been removed from the carriage.

If the shipping tape or protective material is still there, remove it and close the scanning unit / cover (TC-20M only) and the access cover.

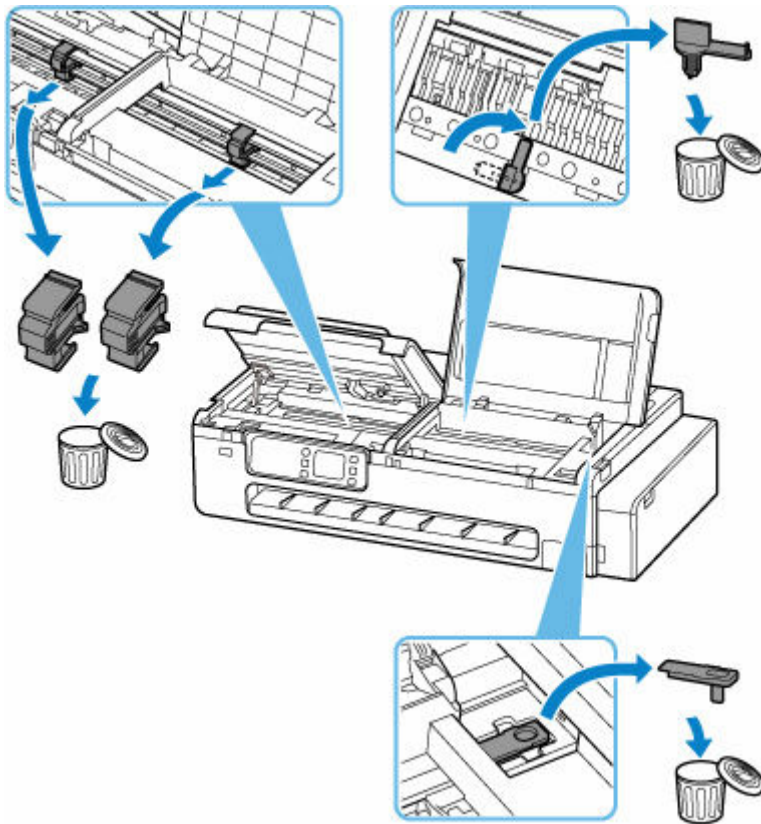

In the case of the first printer setup, select your printer name on the below page, and follow the instructions.

➔ Set Up

15B0

Cause

There may not be enough ink left.

What to Do

Check the remaining ink level and refill the ink of the color that is running low, and then reset the remaining ink count.

- ➔ [Checking Ink Level](#)
- ➔ [Other printer settings](#)

1643

Cause

Ink may have run out.

What to Do

If printing is continued, the printer may consume a certain amount of ink to return to printable status, therefore printing cannot be continued.

To continue printing, refill the ink tank with the corresponding color of ink until the  icon shown on the operation panel disappears.

1723

Cause

The maintenance cartridge is not installed.

What to Do

Install the maintenance cartridge.

Refer to [Replacing the Maintenance Cartridge](#) for details on installing the maintenance cartridge.

1724

Cause

The currently installed maintenance cartridge cannot be used.

This printer cannot use maintenance cartridges that have been installed in other printers.

What to Do

Replace with a new maintenance cartridge.

➔ [Replacing the Maintenance Cartridge](#)

1725

Cause

The maintenance cartridge cannot be recognized.

The maintenance cartridge may not be installed properly or may not be compatible with this printer.

What to Do

Remove the maintenance cartridge, and then reinstall it correctly.

Refer to [Replacing the Maintenance Cartridge](#) for details on removing and installing the maintenance cartridge.

1726

Cause

The maintenance cartridge is full.

What to Do

Replace the maintenance cartridge.

➔ [Replacing the Maintenance Cartridge](#)

➤➤ Note

- The condition of the maintenance cartridge when this error is displayed will depend on where and how the printer is used.

When this message is displayed, you must replace the maintenance cartridge.

1727

Cause

The maintenance cartridge is almost full.

What to Do

The printer will not be able to print with a full maintenance cartridge.

Tap the printer's **OK** button to cancel the error and then prepare a new maintenance cartridge.

For details on the maintenance cartridge, see [Replacing the Maintenance Cartridge](#).

2001

Cause

An unsupported device is connected.

What to Do

Check the device connected to the USB flash drive port. Printing photos directly is possible with a USB flash drive.

2002

Cause

An unsupported USB hub is connected.

What to Do

If a USB flash drive is connected to the printer through the USB hub, disconnect the hub from the printer.

Connect a USB flash drive directly to the printer.

Cause

Paper settings specified when printing do not match the paper information for the top feed registered on the printer.

▶▶▶ Note

- For the appropriate combination of the paper settings specified on the printer driver and the paper information registered on the printer, refer to the paper information list.
 - ➔ Paper Information List
- For copying, make the paper settings for copying match the paper information for the top feed registered on the printer.
- For how to register paper information on the printer, refer to the following.
 - ➔ [Loading Sheets in the Printer](#)
 - ➔ [Changing the Type of Paper](#)

If the paper settings specified when printing differ from the paper information for the top feed registered on the printer, the following message appears on the printer's touch screen.

- Paper settings specified on the printer driver when printing:
Paper size: **A4**
Media type: **Plain paper**
- Paper information for the top feed registered on the printer:
Paper size: **A3**
Media type: **Plain paper**

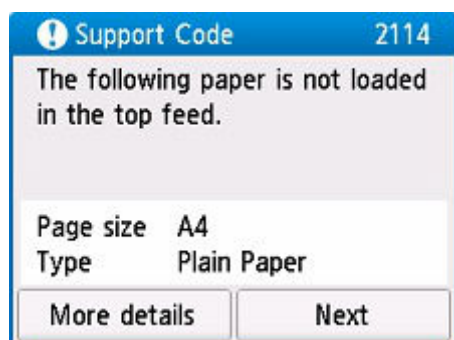

What to Do

Select **Next** on the printer's touch screen to display the screen below.

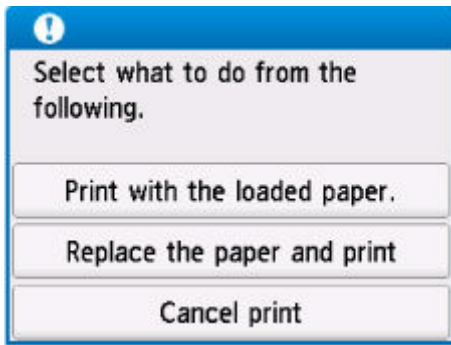

Select the appropriate action.

»» Note

- Depending on the settings, some of the options below may not be displayed.

Print with the loaded paper.

Select this option to print on the loaded paper with the paper settings specified when printing.

For example, when the paper size specified when printing is A4 and the paper information for the top feed is registered as A3, select this option to print on an A3 paper loaded in the top feed with the A4 setting.

Replace the paper and print

Select this option to print after changing the paper in the top feed.

For example, when the paper size specified when printing is A4 and the paper information for the top feed is registered as A3, select this option to print after changing the paper in the top feed with an A4 paper.

After changing the paper, the paper information registration screen for the top feed appears. Register the paper information on the printer according to the loaded paper.

»» Note

- If you do not know the paper size and media type to be loaded in the top feed, press the printer's **Back** button. The paper size and media type are displayed.
- For the appropriate combination of the paper settings specified on the printer driver and the paper information registered on the printer, refer to the paper information list.
 - ➔ Paper Information List

Cancel print

Cancels printing.

Select this option when you want to change the paper settings specified when printing. Change the paper settings and try printing again.

Cause

Paper settings specified when printing do not match the paper information for the paper roll registered on the printer.

Note

- For the appropriate combination of the paper settings specified on the printer driver and the paper information registered on the printer, refer to the paper information list.
 - ➔ Paper Information List
- For copying, make the paper settings for copying match the paper information for the paper roll registered on the printer.
- For how to register paper information on the printer, refer to the following.
 - ➔ [Loading Sheets in the Printer](#)
 - ➔ [Changing the Type of Paper](#)

If the paper settings specified when printing differs from the paper information for the paper roll registered on the printer, the following message appears on the printer's touch screen.

- Paper settings specified on the printer driver when printing:
Paper size: **24 in**
Media type: **Plain paper**
- Paper information for the paper roll registered on the printer:
Paper size: **A2 Roll**
Media type: **Plain paper**

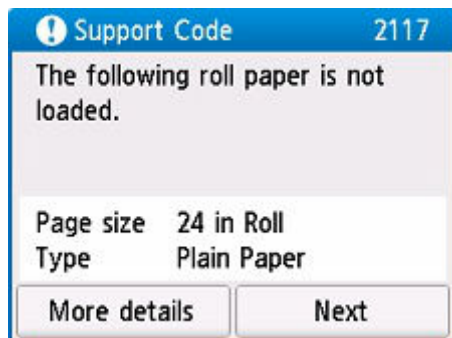

What to Do

Select **Next** on the printer's touch screen to display the screen below.

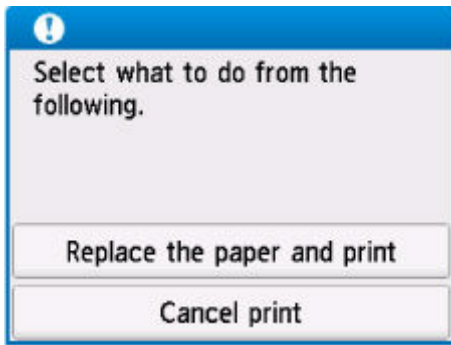

Select the appropriate action.

»» Note

- Depending on the settings, some of the options below may not be displayed.

Replace the paper and print

Select this option to print after replacing the paper roll.

For example, when the paper size specified when printing is 24 in Roll and the paper information for the paper roll is registered as A2 Roll, select this option to print after replacing the paper roll with an 24 in Roll.

After replacing the paper roll, the paper information registration screen for the paper roll appears. Register the paper information on the printer according to the loaded paper.

»» Note

- If you do not know the paper size and media type of the paper roll to be loaded, press the printer's **Back** button. The paper size and media type are displayed.
- For the appropriate combination of the paper settings specified on the printer driver and the paper information registered on the printer, refer to the paper information list.
 - ➔ Paper Information List

Cancel print

Cancels printing.

Select this option when you want to change the paper settings specified when printing. Change the paper settings and try printing again.

Cause

Top feed paper information registration is incomplete. Or, the paper may have been exchanged while the printer is turned off.

What to Do

If the screen similar to the following is displayed on the printer's touch screen, the top feed paper information registration is incomplete.

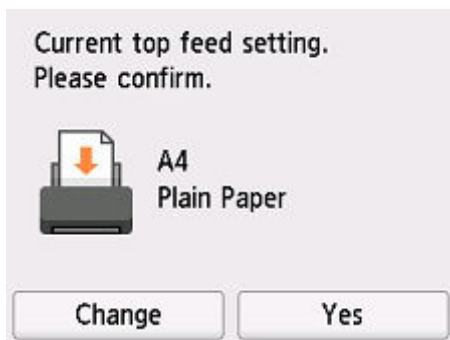

If the paper loaded in the top feed matches the paper information displayed on the printer's touch screen, select **Yes**.

If they do not match, select **Change** and then register the correct paper information.

2200

Cause

An internal part will need replacing soon.

What to Do

Select **OK** on the printer's touch screen to cancel the error.

Contact your nearest Canon service center to request a repair as soon as possible.

You cannot replace the internal parts of the printer yourself.

►► Important

- Do not tilt the printer when moving it since the ink may leak out.
- When transporting the printer for repair, see [Repairing Your Printer](#).

2500

Cause

Cause of following may have occurred failure of automatic adjustment to straighten lines and colors.

- Print head nozzles are clogged.
- Paper roll other than paper roll of 10.00 in. (254.0 mm) width or wider is loaded.
- Paper output slot is exposed to strong light.

What to Do

Select **OK** on the printer's touch screen to cancel the error and take the corresponding actions below.

- Check the print head condition by printing the nozzle check pattern.
- Load a paper roll at least 10.00 in. (254.0 mm) wide.
- Adjust your operating environment and/or the position of the printer so that the paper output slot is not exposed directly to strong light.

After carrying out the above actions, perform automatic adjustment to straighten lines and colors again.

If the error is still not resolved, select **OK** on the printer's touch screen to cancel the error and perform manual adjustment to straighten lines and colors.

➔ [Manual Adjustment to Straighten Lines and Colors](#)

2700

Cause

Some errors occurred while copying and a certain time passed.

What to Do

Tap **OK** on the touch screen to dismiss the error, and try to copy again.

3000

Cause

The print head has not been calibrated.

What to Do

Print Head Alignment - Auto is recommended.

➔ [Automatic Adjustment to Straighten Lines and Colors](#)

➤➤ Note

- This message will appear until **Print Head Alignment - Auto** is carried out.

3252

Cause

The maintenance cartridge is almost full.

What to Do

The printer will not be able to print with a full maintenance cartridge.

Tap the printer's **OK** button to clear the error message.

Cause

Media information cannot be recognized because the printer media information is corrupt.

What to Do

Start the Media Configuration Tool, and then recover the media information.

➔ [Media Configuration Tool Guide](#)

To set the Media Configuration Tool to recovery mode, open the Media Configuration Tool, select this device and then click **OK**.

Select and load the media information backup file.

If you do not have a media information backup file, contact a Canon customer service center.

3310

Cause

Incorrect print data.

Illegal number of parameters.

What to Do

Defective print data, please check the print results.

If using printing software such as RIP (Raster Image Processor), contact the software manufacturer.

3311

Cause

Incorrect print data.

Illegal number of parameters.

What to Do

Defective print data, please check the print results.

If using printing software such as RIP (Raster Image Processor), contact the software manufacturer.

3312

Cause

Incorrect print data.

Illegal number of parameters.

What to Do

Defective print data, please check the print results.

If using printing software such as RIP (Raster Image Processor), contact the software manufacturer.

3313

Cause

Incorrect print data.

Illegal number of parameters.

What to Do

Defective print data, please check the print results.

If using printing software such as RIP (Raster Image Processor), contact the software manufacturer.

3314

Cause

Incorrect print data.

Illegal number of parameters.

What to Do

Defective print data, please check the print results.

If using printing software such as RIP (Raster Image Processor), contact the software manufacturer.

3315

Cause

Incorrect print data.

Illegal number of parameters.

What to Do

Defective print data, please check the print results.

If using printing software such as RIP (Raster Image Processor), contact the software manufacturer.

3316

Cause

Incorrect print data.

Illegal number of parameters.

What to Do

Defective print data, please check the print results.

If using printing software such as RIP (Raster Image Processor), contact the software manufacturer.

3317

Cause

Incorrect print data.

Illegal number of parameters.

What to Do

Defective print data, please check the print results.

If using printing software such as RIP (Raster Image Processor), contact the software manufacturer.

3318

Cause

Incorrect print data.

Illegal number of parameters.

What to Do

Defective print data, please check the print results.

If using printing software such as RIP (Raster Image Processor), contact the software manufacturer.

3319

Cause

Incorrect print data.

Illegal number of parameters.

What to Do

Defective print data, please check the print results.

If using printing software such as RIP (Raster Image Processor), contact the software manufacturer.

3401

Cause

The copy reservation was canceled while printing from the computer.

What to Do

Select **Yes** on the printer's touch screen to cancel the error.

After printing from your computer, try copying again.

3405

Cause

Printer could not make copies because its memory is full.

What to Do

Select **OK** on the printer's touch screen to cancel the error.

Wait a while and retry copying.

If the error is still not resolved, change the copy settings (print quality and other settings) and redo copying.

3407

Cause

Loading next sheet to copy is required.

What to Do

Load the next sheet and select **Scan** on the printer's touch screen.

To print without scanning the next sheet, select **Print now**.

3408

Cause

Preview screen is displayed on printer's touch screen.

What to Do

After seeing the preview, select **Scan** on the printer's touch screen.

To rescan the original, check it and select **Rescan**.

3412

Cause

Scanning original has failed.

What to Do

Select **OK** on the printer's touch screen to cancel the error and take the corresponding actions below.

- Make sure the original is placed on the platen.
- Make sure the original is set in the correct position and orientation on the platen.

After carrying out the above actions, perform the operation again.

If the error is still not resolved, specify the size of the original.

►► Important

- The original that is smaller than 1.2 in. (3 cm) square may not be scanned correctly.

3413

Cause

Prevent paper abrasion has been set.

What to Do

If you continue printing in the current setting, select **Yes** on the printer's touch screen.

Prevent paper abrasion may reduce print speed.

If you disable this setting, select **No**. Select  (**Setup**) on the HOME screen, select **Printer settings**, **Print settings**, and then set **Prevent paper abrasion** to **OFF**.

3414

Cause

Communication with mail server failed.

What to Do

Select **OK** on the printer's touch screen to cancel the error.

Make sure that the address and port number of the outgoing mail server (SMTP server) in mail server settings are correct with Remote UI.

➔ [Setting Mail Server](#)

If the error is not resolved, check your mail server condition.

For settings and condition of your mail server, contact the administrator of mail server.

3415

Cause

Communication with mail server failed.

What to Do

Select **OK** on the printer's touch screen to cancel the error.

Make sure that the address and port number of the incoming mail server (POP3 server) in mail server settings are correct with Remote UI.

➔ [Setting Mail Server](#)

If the error is not resolved, check your mail server condition.

For settings and condition of your mail server, contact the administrator of mail server.

3416

Cause

Communication with mail server failed.

What to Do

Select **OK** on the printer's touch screen to cancel the error.

Make sure that the settings for secure connection (SSL) of your mail server and printer are match.

For printer's settings for secure connection (SSL), use Remote UI.

➔ [Setting Mail Server](#)

For setting for secure connection (SSL) of your mail server, contact the administrator of mail server.

3417

Cause

Communication with mail server failed.

What to Do

Select **OK** on the printer's touch screen to cancel the error.

Make sure that the settings for secure connection (SSL) of your mail server and printer are match.

For printer's settings for secure connection (SSL), use Remote UI.

➔ [Setting Mail Server](#)

For setting for secure connection (SSL) of your mail server, contact the administrator of mail server.

3418

Cause

Communication with mail server failed.

What to Do

Select **OK** on the printer's touch screen to cancel the error.

Make sure that the settings item for the outgoing mail server (SMTP server) are correct with Remote UI.

➔ [Setting Mail Server](#)

If the error is not resolved, check your mail server condition.

For settings and condition of your mail server, contact the administrator of mail server.

3419

Cause

Communication with mail server failed.

What to Do

Select **OK** on the printer's touch screen to cancel the error.

Make sure that the outgoing account and outgoing password in mail server settings are correct with Remote UI.

➔ [Setting Mail Server](#)

If the error is not resolved, check your mail server condition.

For settings and condition of your mail server, contact the administrator of mail server.

3420

Cause

Communication with mail server failed.

What to Do

Select **OK** on the printer's touch screen to cancel the error.

Make sure that the settings item for the incoming mail server (POP3 server) are correct with Remote UI.

➔ [Setting Mail Server](#)

If the error is not resolved, check your mail server condition.

For settings and condition of your mail server, contact the administrator of mail server.

3421

Cause

Communication with mail server failed.

What to Do

Select **OK** on the printer's touch screen to cancel the error.

Make sure that the incoming account and incoming password in mail server settings are correct with Remote UI.

➔ [Setting Mail Server](#)

If the error is not resolved, check your mail server condition.

For settings and condition of your mail server, contact the administrator of mail server.

3422

Cause

Communication with mail server failed.

What to Do

Select **OK** on the printer's touch screen to cancel the error.

Make sure that the APOP authentication settings of your mail server and printer are match.

For printer's APOP authentication setting, use Remote UI.

➔ [Setting Mail Server](#)

If the error is not resolved, check your mail server condition.

For APOP authentication setting of your mail server, contact the administrator of mail server.

3423

Cause

Communication with mail server failed.

What to Do

Select **OK** on the printer's touch screen to cancel the error.

Make sure that the mail server settings are correct with Remote UI.

➔ [Setting Mail Server](#)

If the error is not resolved, check your mail server condition.

For settings and condition of your mail server, contact the administrator of mail server.

3424

Cause

Sending mail failed.

What to Do

Select **OK** on the printer's touch screen to cancel the error.

Specify the correct destination's mail address, and then retry sending mail.

Cause

Cause of following may have occurred failure of sending mail.

- File size of scanned data is too large.
- Printer's memory is full.

What to Do

Select **OK** on the printer's touch screen to cancel the error.

Take the corresponding actions below.

- Lower the resolution and retry to scanning.
- Reduce the documents and retry to scanning.

If the error is not resolved, take the corresponding actions below.

- Check the maximum attachment file size for sending the scanned data.

You can set the maximum attachment file size with Remote UI.

➔ [Specifying Mail Setting for Sending Scanned Data](#)

- Check your mail server condition.

3438

Cause

Original is left on platen.

What to Do

Make sure no original is on the platen and select **OK** on the printer's touch screen to cancel the error.

3440

Cause

Easy wireless connect has failed.

What to Do

Select **OK** on the printer's touch screen to cancel the error and retry Easy wireless connect.

If the error is not resolved, use another method to set up Wi-Fi.

3441

Cause

Easy wireless connect has failed.

What to Do

Select **OK** on the printer's touch screen to cancel the error and retry Easy wireless connect.

If the error is not resolved, use another method to set up Wi-Fi.

Cause

Printing of the first side is complete when doing manual duplex printing.

What to Do

Prepare to print the other side.

Load the paper with the printed side facing down in the top feed without changing its orientation.

Select **How to set** on the printer's touch screen to see how to load the paper.

After loading the paper, select **Start print** on the printer's touch screen.

▶▶▶ Note

- To cancel printing, press the printer's **Stop** button.

Cause

Printing of the first side is complete when doing manual duplex printing.

What to Do

Prepare to print the other side.

Rotate the printed paper 180 degrees and load it with the printed side facing down in the top feed.

Select **How to set** on the printer's touch screen to see how to load the paper.

After loading the paper, select **Start print** on the printer's touch screen.

▶▶ Note

- To cancel printing, press the printer's **Stop** button.

3444

Cause

Printing of the first side is complete when doing manual duplex printing.

What to Do

Prepare to print the other side.

Rotate the printed paper 180 degrees and load it with the printed side facing down in the top feed.

Select **How to set** on the printer's touch screen to see how to load the paper.

After loading the paper, select **Start print** on the printer's touch screen.

▶▶▶ Note

- To cancel printing, press the printer's **Stop** button.

Cause

Printing of the first side is complete when doing manual duplex printing.

What to Do

Prepare to print the other side.

Load the paper with the printed side facing down in the top feed without changing its orientation.

Select **How to set** on the printer's touch screen to see how to load the paper.

After loading the paper, select **Start print** on the printer's touch screen.

▶▶▶ Note

- To cancel printing, press the printer's **Stop** button.

3446

Cause

IP address and subnet mask are conflicting.

What to Do

Select **OK** on the printer's touch screen to cancel the error.

Disable the wireless direct or change the Wi-Fi network configuration. When changing the network configuration, specify a unique subnet range for each of the wireless direct and the Wi-Fi to prevent a conflict.

For details on changing the network configuration, refer to the documentation for your wireless router.

3447

Cause

An error occurred while communicating via wireless direct or while in standby.

What to Do

Select **OK** on the printer's touch screen to cancel the error.

Turn off the printer and turn it back on.

Wireless direct becomes enabled.

4103

Cause

Cannot perform printing with current print settings.

What to Do

Press the printer's **Stop** button to cancel printing.

Change the print settings specified when printing and retry printing.

Cause

The paper settings (paper size/paper type) or paper feed method specified when printing are incorrect.

What to Do

Press the **Stop** button on the printer to stop printing, and then check the paper roll or the paper that can be loaded in the top feed.

- ➔ [Loading Rolls in the Printer](#)
- ➔ [Loading Sheets in the Printer](#)

Do one of the following, and then try printing again.

- Change the paper settings (paper size/ paper type) specified when printing.
- Change the paper feeding method.

4111

Cause

The media type specified is incompatible with this device.

What to Do

Press the printer's **Stop** button to stop printing.

Check the media type settings, and then try again.

Cause

Cannot cut paper for one of the following reasons.

- Paper that has been cut remains on the output guide.
- There is a foreign object near the output slot that is obstructing the cutter blade.
- The paper is not being used under the recommended usage conditions.
- The paper in use cannot be used with **Automatic cut**.

What to Do

Remove jammed paper.

➔ [Remove Jammed Roll Paper](#)

➔ [Remove a Jammed Sheet](#)

After removing the jammed paper, select **OK** on the printer's touch screen to cancel the error.

Cause

Paper feed adjustment may have failed for the following reasons.

- The paper for printing a test pattern is soiled. Otherwise, you have loaded colored paper.
- The printer may be exposed to strong light, such as direct sunlight, which can cause the sensors to malfunction.
- The test pattern was printed too faintly.

What to Do

Tap **OK** on the touch screen to dismiss the error, and then take the following actions.

- Load unused paper.
- Make adjustments to ensure that the printer is not exposed to strong light.
- Print a nozzle check pattern to check the print head status.

If the pattern has gaps or horizontal white lines, the print head nozzle is blocked. Clean the print head.

➔ [Checking for Nozzle Clogging](#)

495A

Cause

An error occurred while communicating via Wi-Fi or while in standby.

What to Do

Turn off the printer and turn it back on.

5011

Cause

Printer error has occurred.

What to Do

Turn off the printer and unplug it.

Plug in the printer again and turn it back on.

If this does not solve the problem, contact your nearest Canon service center to request a repair.

▶▶ Important

- Do not tilt the printer when moving it since the ink may leak out.
- When transporting the printer for repairing it, see [Repairing Your Printer](#).

5012

Cause

Printer error has occurred.

What to Do

Turn off the printer and unplug it.

Plug in the printer again and turn it back on.

If this does not solve the problem, contact your nearest Canon service center to request a repair.

▶▶ Important

- Do not tilt the printer when moving it since the ink may leak out.
- When transporting the printer for repairing it, see [Repairing Your Printer](#).

5050

Cause

Printer error has occurred.

What to Do

Turn off the printer and unplug it.

Plug in the printer again and turn it back on.

If this does not solve the problem, contact your nearest Canon service center to request a repair.

▶▶ Important

- Do not tilt the printer when moving it since the ink may leak out.
- When transporting the printer for repairing it, see [Repairing Your Printer](#).

Cause

Printer error has occurred.

What to Do

If you are printing, press the printer's **Stop** button to cancel printing, then turn off the printer.

Check the following:

- Make sure carriage motion is not impeded by protective material and tape for securing the carriage, jammed paper, etc.

Remove any impediment.

►► Important

- Do not touch the linear scale (A) or carriage rail (B). This may stain your hands and damage the printer.

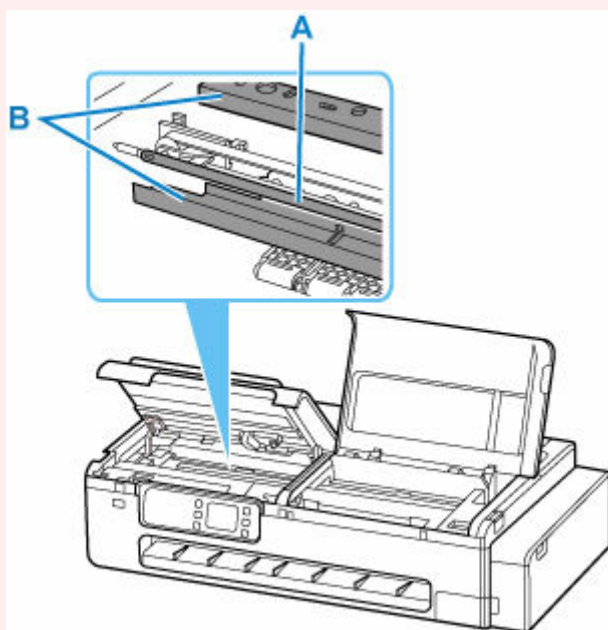

Turn the printer back on.

If this does not solve the problem, contact your nearest Canon service center to request a repair.

►► Important

- Do not tilt the printer when moving it since the ink may leak out.
- When transporting the printer for repairing it, see [Repairing Your Printer](#).

5108

Cause

Printer error has occurred.

What to Do

Turn off the printer and unplug it.

Plug in the printer again and turn it back on.

If this does not solve the problem, contact your nearest Canon service center to request a repair.

▶▶ Important

- Do not tilt the printer when moving it since the ink may leak out.
- When transporting the printer for repairing it, see [Repairing Your Printer](#).

5200

Cause

Printer error has occurred.

What to Do

Turn off the printer and unplug it.

Wait about 10 minutes and then plug in the printer again and turn it back on.

Make sure there is enough ink remaining, and perform replace ink in print head.

➔ [Checking Ink Level](#)

- From Windows:
 - ➔ [Cleaning the Print Heads](#)
- From macOS:
 - ➔ [Cleaning the Print Heads](#)
- From the operation panel of the printer:
 - ➔ [Replacing the Ink in the Print Head](#)

If this does not solve the problem, contact your nearest Canon service center to request a repair.

»» Important

- Do not tilt the printer when moving it since the ink may leak out.
- When transporting the printer for repairing it, see [Repairing Your Printer](#).

5207

Cause

Printer error has occurred.

What to Do

Turn off the printer and unplug it.

Plug in the printer again and turn it back on.

If this does not solve the problem, contact your nearest Canon service center to request a repair.

▶▶ Important

- Do not tilt the printer when moving it since the ink may leak out.
- When transporting the printer for repairing it, see [Repairing Your Printer](#).

5700

Cause

Printer error has occurred.

What to Do

Turn off the printer and unplug it.

Plug in the printer again and turn it back on.

If this does not solve the problem, contact your nearest Canon service center to request a repair.

▶▶ Important

- Do not tilt the printer when moving it since the ink may leak out.
- When transporting the printer for repairing it, see [Repairing Your Printer](#).

5C02

Cause

Printer error has occurred.

What to Do

Turn off the printer and unplug it.

Plug in the printer again and turn it back on.

If this does not solve the problem, contact your nearest Canon service center to request a repair.

▶▶ Important

- Do not tilt the printer when moving it since the ink may leak out.
- When transporting the printer for repairing it, see [Repairing Your Printer](#).

5C30

Cause

An error requiring a repair has occurred.

What to Do

Turn off the printer and unplug it.

Contact your nearest Canon service center to request a repair.

»» Important

- Do not tilt the printer when moving it since the ink may leak out.
- When transporting the printer for repairing it, see [Repairing Your Printer](#).

6000

Cause

Printer error has occurred.

What to Do

Turn off the printer and unplug it.

Plug in the printer again and turn it back on.

If this does not solve the problem, contact your nearest Canon service center to request a repair.

▶▶ Important

- Do not tilt the printer when moving it since the ink may leak out.
- When transporting the printer for repairing it, see [Repairing Your Printer](#).

6001

Cause

Printer error has occurred.

What to Do

Turn off the printer and unplug it.

Plug in the printer again and turn it back on.

If this does not solve the problem, contact your nearest Canon service center to request a repair.

▶▶ Important

- Do not tilt the printer when moving it since the ink may leak out.
- When transporting the printer for repairing it, see [Repairing Your Printer](#).

6004

Cause

Printer error has occurred.

What to Do

Turn off the printer and unplug it.

Plug in the printer again and turn it back on.

If this does not solve the problem, contact your nearest Canon service center to request a repair.

▶▶ Important

- Do not tilt the printer when moving it since the ink may leak out.
- When transporting the printer for repairing it, see [Repairing Your Printer](#).

6011

Cause

Printer error has occurred.

What to Do

Turn off the printer and unplug it.

Plug in the printer again and turn it back on.

If this does not solve the problem, contact your nearest Canon service center to request a repair.

▶▶ Important

- Do not tilt the printer when moving it since the ink may leak out.
- When transporting the printer for repairing it, see [Repairing Your Printer](#).

6012

Cause

Printer error has occurred.

What to Do

Turn off the printer and unplug it.

Plug in the printer again and turn it back on.

If this does not solve the problem, contact your nearest Canon service center to request a repair.

▶▶ Important

- Do not tilt the printer when moving it since the ink may leak out.
- When transporting the printer for repairing it, see [Repairing Your Printer](#).

6013

Cause

Printer error has occurred.

What to Do

Turn off the printer and unplug it.

Plug in the printer again and turn it back on.

If this does not solve the problem, contact your nearest Canon service center to request a repair.

▶▶ Important

- Do not tilt the printer when moving it since the ink may leak out.
- When transporting the printer for repairing it, see [Repairing Your Printer](#).

6014

Cause

Printer error has occurred.

What to Do

Turn off the printer and unplug it.

Plug in the printer again and turn it back on.

If this does not solve the problem, contact your nearest Canon service center to request a repair.

▶▶ Important

- Do not tilt the printer when moving it since the ink may leak out.
- When transporting the printer for repairing it, see [Repairing Your Printer](#).

6015

Cause

Printer error has occurred.

What to Do

Turn off the printer and unplug it.

Plug in the printer again and turn it back on.

If this does not solve the problem, contact your nearest Canon service center to request a repair.

▶▶ Important

- Do not tilt the printer when moving it since the ink may leak out.
- When transporting the printer for repairing it, see [Repairing Your Printer](#).

6016

Cause

Printer error has occurred.

What to Do

Turn off the printer and unplug it.

Plug in the printer again and turn it back on.

If this does not solve the problem, contact your nearest Canon service center to request a repair.

▶▶ Important

- Do not tilt the printer when moving it since the ink may leak out.
- When transporting the printer for repairing it, see [Repairing Your Printer](#).

6017

Cause

Printer error has occurred.

What to Do

Turn off the printer and unplug it.

Plug in the printer again and turn it back on.

If this does not solve the problem, contact your nearest Canon service center to request a repair.

▶▶ Important

- Do not tilt the printer when moving it since the ink may leak out.
- When transporting the printer for repairing it, see [Repairing Your Printer](#).

6018

Cause

Printer error has occurred.

What to Do

Turn off the printer and unplug it.

Plug in the printer again and turn it back on.

If this does not solve the problem, contact your nearest Canon service center to request a repair.

▶▶ Important

- Do not tilt the printer when moving it since the ink may leak out.
- When transporting the printer for repairing it, see [Repairing Your Printer](#).

6019

Cause

Printer error has occurred.

What to Do

Turn off the printer and unplug it.

Plug in the printer again and turn it back on.

If this does not solve the problem, contact your nearest Canon service center to request a repair.

▶▶ Important

- Do not tilt the printer when moving it since the ink may leak out.
- When transporting the printer for repairing it, see [Repairing Your Printer](#).

6030

Cause

Printer error has occurred.

What to Do

Turn off the printer and unplug it.

Plug in the printer again and turn it back on.

If this does not solve the problem, contact your nearest Canon service center to request a repair.

▶▶ Important

- Do not tilt the printer when moving it since the ink may leak out.
- When transporting the printer for repairing it, see [Repairing Your Printer](#).

6500

Cause

Printer error has occurred.

What to Do

Turn off the printer and unplug it.

Plug in the printer again and turn it back on.

If this does not solve the problem, contact your nearest Canon service center to request a repair.

▶▶ Important

- Do not tilt the printer when moving it since the ink may leak out.
- When transporting the printer for repairing it, see [Repairing Your Printer](#).

6503

Cause

Printer error has occurred.

What to Do

Turn off the printer and unplug it.

Plug in the printer again and turn it back on.

If this does not solve the problem, contact your nearest Canon service center to request a repair.

▶▶ Important

- Do not tilt the printer when moving it since the ink may leak out.
- When transporting the printer for repairing it, see [Repairing Your Printer](#).

6700

Cause

Printer error has occurred.

What to Do

Turn off the printer and unplug it.

Plug in the printer again and turn it back on.

If this does not solve the problem, contact your nearest Canon service center to request a repair.

▶▶ Important

- Do not tilt the printer when moving it since the ink may leak out.
- When transporting the printer for repairing it, see [Repairing Your Printer](#).

6701

Cause

Printer error has occurred.

What to Do

Turn off the printer and unplug it.

Plug in the printer again and turn it back on.

If this does not solve the problem, contact your nearest Canon service center to request a repair.

▶▶ Important

- Do not tilt the printer when moving it since the ink may leak out.
- When transporting the printer for repairing it, see [Repairing Your Printer](#).

6800

Cause

Printer error has occurred.

What to Do

Turn off the printer and unplug it.

Plug in the printer again and turn it back on.

If this does not solve the problem, contact your nearest Canon service center to request a repair.

▶▶ Important

- Do not tilt the printer when moving it since the ink may leak out.
- When transporting the printer for repairing it, see [Repairing Your Printer](#).

6801

Cause

Printer error has occurred.

What to Do

Turn off the printer and unplug it.

Plug in the printer again and turn it back on.

If this does not solve the problem, contact your nearest Canon service center to request a repair.

▶▶ Important

- Do not tilt the printer when moving it since the ink may leak out.
- When transporting the printer for repairing it, see [Repairing Your Printer](#).

6830

Cause

Printer error has occurred.

What to Do

Turn off the printer and unplug it.

Plug in the printer again and turn it back on.

If this does not solve the problem, contact your nearest Canon service center to request a repair.

▶▶ Important

- Do not tilt the printer when moving it since the ink may leak out.
- When transporting the printer for repairing it, see [Repairing Your Printer](#).

6831

Cause

Printer error has occurred.

What to Do

Turn off the printer and unplug it.

Plug in the printer again and turn it back on.

If this does not solve the problem, contact your nearest Canon service center to request a repair.

▶▶ Important

- Do not tilt the printer when moving it since the ink may leak out.
- When transporting the printer for repairing it, see [Repairing Your Printer](#).

6832

Cause

Printer error has occurred.

What to Do

Turn off the printer and unplug it.

Plug in the printer again and turn it back on.

If this does not solve the problem, contact your nearest Canon service center to request a repair.

▶▶ Important

- Do not tilt the printer when moving it since the ink may leak out.
- When transporting the printer for repairing it, see [Repairing Your Printer](#).

6833

Cause

Printer error has occurred.

What to Do

Turn off the printer and unplug it.

Plug in the printer again and turn it back on.

If this does not solve the problem, contact your nearest Canon service center to request a repair.

▶▶ Important

- Do not tilt the printer when moving it since the ink may leak out.
- When transporting the printer for repairing it, see [Repairing Your Printer](#).

6900

Cause

Printer error has occurred.

What to Do

Turn off the printer and unplug it.

Plug in the printer again and turn it back on.

If this does not solve the problem, contact your nearest Canon service center to request a repair.

▶▶ Important

- Do not tilt the printer when moving it since the ink may leak out.
- When transporting the printer for repairing it, see [Repairing Your Printer](#).

6901

Cause

Printer error has occurred.

What to Do

Turn off the printer and unplug it.

Plug in the printer again and turn it back on.

If this does not solve the problem, contact your nearest Canon service center to request a repair.

▶▶ Important

- Do not tilt the printer when moving it since the ink may leak out.
- When transporting the printer for repairing it, see [Repairing Your Printer](#).

6902

Cause

Printer error has occurred.

What to Do

Turn off the printer and unplug it.

Plug in the printer again and turn it back on.

If this does not solve the problem, contact your nearest Canon service center to request a repair.

▶▶ Important

- Do not tilt the printer when moving it since the ink may leak out.
- When transporting the printer for repairing it, see [Repairing Your Printer](#).

6910

Cause

Printer error has occurred.

What to Do

Turn off the printer and unplug it.

Plug in the printer again and turn it back on.

If this does not solve the problem, contact your nearest Canon service center to request a repair.

▶▶ Important

- Do not tilt the printer when moving it since the ink may leak out.
- When transporting the printer for repairing it, see [Repairing Your Printer](#).

6920

Cause

Printer error has occurred.

What to Do

Turn off the printer and unplug it.

Plug in the printer again and turn it back on.

If this does not solve the problem, contact your nearest Canon service center to request a repair.

▶▶ Important

- Do not tilt the printer when moving it since the ink may leak out.
- When transporting the printer for repairing it, see [Repairing Your Printer](#).

6921

Cause

Printer error has occurred.

What to Do

Turn off the printer and unplug it.

Plug in the printer again and turn it back on.

If this does not solve the problem, contact your nearest Canon service center to request a repair.

▶▶ Important

- Do not tilt the printer when moving it since the ink may leak out.
- When transporting the printer for repairing it, see [Repairing Your Printer](#).

6930

Cause

Printer error has occurred.

What to Do

Turn off the printer and unplug it.

Plug in the printer again and turn it back on.

If this does not solve the problem, contact your nearest Canon service center to request a repair.

▶▶ Important

- Do not tilt the printer when moving it since the ink may leak out.
- When transporting the printer for repairing it, see [Repairing Your Printer](#).

6931

Cause

Printer error has occurred.

What to Do

Turn off the printer and unplug it.

Plug in the printer again and turn it back on.

If this does not solve the problem, contact your nearest Canon service center to request a repair.

▶▶ Important

- Do not tilt the printer when moving it since the ink may leak out.
- When transporting the printer for repairing it, see [Repairing Your Printer](#).

6932

Cause

Printer error has occurred.

What to Do

Turn off the printer and unplug it.

Plug in the printer again and turn it back on.

If this does not solve the problem, contact your nearest Canon service center to request a repair.

▶▶ Important

- Do not tilt the printer when moving it since the ink may leak out.
- When transporting the printer for repairing it, see [Repairing Your Printer](#).

6933

Cause

Printer error has occurred.

What to Do

Turn off the printer and unplug it.

Plug in the printer again and turn it back on.

If this does not solve the problem, contact your nearest Canon service center to request a repair.

▶▶ Important

- Do not tilt the printer when moving it since the ink may leak out.
- When transporting the printer for repairing it, see [Repairing Your Printer](#).

6936

Cause

Printer error has occurred.

What to Do

Turn off the printer and unplug it.

Plug in the printer again and turn it back on.

If this does not solve the problem, contact your nearest Canon service center to request a repair.

▶▶ Important

- Do not tilt the printer when moving it since the ink may leak out.
- When transporting the printer for repairing it, see [Repairing Your Printer](#).

Cause

Printer error has occurred.

What to Do

Turn off the printer and unplug it.

Plug in the printer again and turn it back on.

If this does not solve the problem, contact your nearest Canon service center to request a repair.

▶▶ Important

- Do not tilt the printer when moving it since the ink may leak out.
- When transporting the printer for repairing it, see [Repairing Your Printer](#).

6938

Cause

Printer error has occurred.

What to Do

Turn off the printer and unplug it.

Plug in the printer again and turn it back on.

If this does not solve the problem, contact your nearest Canon service center to request a repair.

▶▶ Important

- Do not tilt the printer when moving it since the ink may leak out.
- When transporting the printer for repairing it, see [Repairing Your Printer](#).

6940

Cause

Printer error has occurred.

What to Do

Turn off the printer and unplug it.

Plug in the printer again and turn it back on.

If this does not solve the problem, contact your nearest Canon service center to request a repair.

▶▶ Important

- Do not tilt the printer when moving it since the ink may leak out.
- When transporting the printer for repairing it, see [Repairing Your Printer](#).

6941

Cause

Printer error has occurred.

What to Do

Turn off the printer and unplug it.

Plug in the printer again and turn it back on.

If this does not solve the problem, contact your nearest Canon service center to request a repair.

▶▶ Important

- Do not tilt the printer when moving it since the ink may leak out.
- When transporting the printer for repairing it, see [Repairing Your Printer](#).

6942

Cause

Printer error has occurred.

What to Do

Turn off the printer and unplug it.

Plug in the printer again and turn it back on.

If this does not solve the problem, contact your nearest Canon service center to request a repair.

▶▶ Important

- Do not tilt the printer when moving it since the ink may leak out.
- When transporting the printer for repairing it, see [Repairing Your Printer](#).

6943

Cause

Printer error has occurred.

What to Do

Turn off the printer and unplug it.

Plug in the printer again and turn it back on.

If this does not solve the problem, contact your nearest Canon service center to request a repair.

▶▶ Important

- Do not tilt the printer when moving it since the ink may leak out.
- When transporting the printer for repairing it, see [Repairing Your Printer](#).

6944

Cause

Printer error has occurred.

What to Do

Turn off the printer and unplug it.

Plug in the printer again and turn it back on.

If this does not solve the problem, contact your nearest Canon service center to request a repair.

▶▶ Important

- Do not tilt the printer when moving it since the ink may leak out.
- When transporting the printer for repairing it, see [Repairing Your Printer](#).

6945

Cause

Printer error has occurred.

What to Do

Turn off the printer and unplug it.

Plug in the printer again and turn it back on.

If this does not solve the problem, contact your nearest Canon service center to request a repair.

▶▶ Important

- Do not tilt the printer when moving it since the ink may leak out.
- When transporting the printer for repairing it, see [Repairing Your Printer](#).

6946

Cause

Printer error has occurred.

What to Do

Turn off the printer and unplug it.

Plug in the printer again and turn it back on.

If this does not solve the problem, contact your nearest Canon service center to request a repair.

▶▶ Important

- Do not tilt the printer when moving it since the ink may leak out.
- When transporting the printer for repairing it, see [Repairing Your Printer](#).

6A80

Cause

Printer error has occurred.

What to Do

Turn off the printer and unplug it.

Plug in the printer again and turn it back on.

If this does not solve the problem, contact your nearest Canon service center to request a repair.

▶▶ Important

- Do not tilt the printer when moving it since the ink may leak out.
- When transporting the printer for repairing it, see [Repairing Your Printer](#).

6A81

Cause

Printer error has occurred.

What to Do

Turn off the printer and unplug it.

Plug in the printer again and turn it back on.

If this does not solve the problem, contact your nearest Canon service center to request a repair.

▶▶ Important

- Do not tilt the printer when moving it since the ink may leak out.
- When transporting the printer for repairing it, see [Repairing Your Printer](#).

6D01

Cause

Printer error has occurred.

What to Do

Turn off the printer and unplug it.

Plug in the printer again and turn it back on.

If this does not solve the problem, contact your nearest Canon service center to request a repair.

▶▶ Important

- Do not tilt the printer when moving it since the ink may leak out.
- When transporting the printer for repairing it, see [Repairing Your Printer](#).

7500

Cause

An error requiring a repair has occurred.

What to Do

Turn off the printer and unplug it.

Contact your nearest Canon service center to request a repair.

»» Important

- Do not tilt the printer when moving it since the ink may leak out.
- When transporting the printer for repairing it, see [Repairing Your Printer](#).

7600

Cause

An error requiring a repair has occurred.

What to Do

Turn off the printer and unplug it.

Contact your nearest Canon service center to request a repair.

»» Important

- Do not tilt the printer when moving it since the ink may leak out.
- When transporting the printer for repairing it, see [Repairing Your Printer](#).

7700

Cause

An error requiring a repair has occurred.

What to Do

Turn off the printer and unplug it.

Contact your nearest Canon service center to request a repair.

»» Important

- Do not tilt the printer when moving it since the ink may leak out.
- When transporting the printer for repairing it, see [Repairing Your Printer](#).

7800

Cause

An error requiring a repair has occurred.

What to Do

Turn off the printer and unplug it.

Contact your nearest Canon service center to request a repair.

»» Important

- Do not tilt the printer when moving it since the ink may leak out.
- When transporting the printer for repairing it, see [Repairing Your Printer](#).

8200

Cause

Printer error has occurred.

What to Do

Turn off the printer and unplug it.

Plug in the printer again and turn it back on.

If this does not solve the problem, contact your nearest Canon service center to request a repair.

▶▶ Important

- Do not tilt the printer when moving it since the ink may leak out.
- When transporting the printer for repairing it, see [Repairing Your Printer](#).

9000

Cause

Printer error has occurred.

What to Do

Turn off the printer and unplug it.

Plug in the printer again and turn it back on.

If this does not solve the problem, contact your nearest Canon service center to request a repair.

▶▶ Important

- Do not tilt the printer when moving it since the ink may leak out.
- When transporting the printer for repairing it, see [Repairing Your Printer](#).

B506

Cause

Printer error has occurred.

What to Do

Turn off the printer and unplug it.

Plug in the printer again and turn it back on.

If this does not solve the problem, contact your nearest Canon service center to request a repair.

▶▶ Important

- Do not tilt the printer when moving it since the ink may leak out.
- When transporting the printer for repairing it, see [Repairing Your Printer](#).

B508

Cause

Printer error has occurred.

What to Do

Turn off the printer and unplug it.

Plug in the printer again and turn it back on.

If this does not solve the problem, contact your nearest Canon service center to request a repair.

▶▶ Important

- Do not tilt the printer when moving it since the ink may leak out.
- When transporting the printer for repairing it, see [Repairing Your Printer](#).

B509

Cause

Printer error has occurred.

What to Do

Turn off the printer and unplug it.

Plug in the printer again and turn it back on.

If this does not solve the problem, contact your nearest Canon service center to request a repair.

▶▶ Important

- Do not tilt the printer when moving it since the ink may leak out.
- When transporting the printer for repairing it, see [Repairing Your Printer](#).

B50A

Cause

Printer error has occurred.

What to Do

Turn off the printer and unplug it.

Contact your nearest Canon service center to request a repair.

»» Important

- Do not tilt the printer when moving it since the ink may leak out.
- When transporting the printer for repairing it, see [Repairing Your Printer](#).

C000

Cause

Printer error has occurred.

What to Do

Turn off the printer and unplug it.

Plug in the printer again and turn it back on.

If this does not solve the problem, contact your nearest Canon service center to request a repair.

▶▶ Important

- Do not tilt the printer when moving it since the ink may leak out.
- When transporting the printer for repairing it, see [Repairing Your Printer](#).

D103

Cause

The printer is in the reset process and cannot be operated.

What to Do

Wait for a while until the process is completed.

D107

Cause

The printer is in operation process and cannot be operated.

What to Do

Wait for a while until the process is completed.

D108

Cause

The printer is in the process of moving the carriage and cannot be operated.

What to Do

Wait for a while until the process is completed.

D109

Cause

Firmware updates are available.

What to Do

When update notifications are configured, a notification will appear when there is an available update.

Specifications

- Specifications
- Print Area

Specifications

- ➔ Printer specifications
 - ➔ [TC-20M](#)
 - ➔ [TC-20](#)
- ➔ [Printing performance](#)
- ➔ [Scan Specifications \(for TC-20M only\)](#)
- ➔ [Memory](#)
- ➔ [Interface](#)
- ➔ [Network Specifications](#)
- ➔ [Operating Conditions](#)
- ➔ [Paper](#)

➔➔➔ Important

- The following values may vary depending on the operating environment.

Printer specifications

TC-20M

Power supply	100-240 V AC (50/60 Hz)
Power consumption	When copying (wired LAN connection): 26 W max. Standby (wired LAN connection): 1.9 W max. Standby (all ports connected): 2.4 W max. When power is off: 0.3 W max. *1 *1 The printer uses a trace amount of power even when turned off. To stop all power consumption, turn off the printer and unplug the power cord.
Operating environment	Temperature: 59 to 86 °F (15 to 30 °C) Humidity: 10 to 80 % RH (with no condensation)
Dimensions (W x D x H)	Printer only: Approx. 38.2 x 20.7 x 9.7 in. (968 x 525 x 245 mm) Printer and Desktop Basket BU-06 (when the basket is opened): Approx. 38.2 x 32.5 x 38.0 in. (968 x 825 x 965 mm) Printer and Stand SD-24 (when the basket is opened): Approx. 38.2 x 34.3 x 34.5 in. (968 x 870 x 874 mm)
Weight	Printer only *: Approx. 72 lb (33 kg) Printer and Desktop Basket BU-06 *: Approx. 74 lb (34 kg) Printer and Stand SD-24 *: Approx. 91 lb (42 kg)

	* With the Print Head installed.
Space for installation (W x D x H)	<p>Printer only: Approx. 46.0 x 44.3 x 29.4 in. (1168 x 1125 x 745 mm)</p> <p>Printer and Desktop Basket BU-06 (when the basket is opened): Approx. 46.0 x 56.2 x 57.7 in. (1168 x 1425 x 1465 mm)</p> <p>Printer and Stand SD-24 (when the basket is opened): Approx. 46.0 x 57.9 x 54.1 in. (1168 x 1470 x 1374 mm)</p>

TC-20

Power supply	100-240 V AC (50/60 Hz)
Power consumption	<p>When printing (wired LAN connection): 28 W max.</p> <p>Standby (wired LAN connection): 1.8 W max.</p> <p>Standby (all ports connected): 2.4 W max.</p> <p>When power is off: 0.3 W max. *1</p> <p>*1 The printer uses a trace amount of power even when turned off. To stop all power consumption, turn off the printer and unplug the power cord.</p>
Operating environment	<p>Temperature: 59 to 86 °F (15 to 30 °C)</p> <p>Humidity: 10 to 80 % RH (with no condensation)</p>
Dimensions (W x D x H)	<p>Printer only: Approx. 38.2 x 20.7 x 9.7 in. (968 x 525 x 245 mm)</p> <p>Printer and Desktop Basket BU-06 (when the basket is opened): Approx. 38.2 x 32.5 x 38.0 in. (968 x 825 x 965 mm)</p> <p>Printer and Stand SD-24 (when the basket is opened): Approx. 38.2 x 34.3 x 34.5 in. (968 x 870 x 874 mm)</p>
Weight	<p>Printer only *: Approx. 69 lb (32 kg)</p> <p>Printer and Desktop Basket BU-06 *: Approx. 71 lb (33 kg)</p> <p>Printer and Stand SD-24 *: Approx. 88 lb (40 kg)</p> <p>* With the Print Head installed.</p>
Space for installation (W x D x H)	<p>Printer only: Approx. 46.0 x 44.3 x 29.4 in. (1168 x 1125 x 745 mm)</p> <p>Printer and Desktop Basket BU-06 (when the basket is opened): Approx. 46.0 x 56.2 x 57.7 in. (1168 x 1425 x 1465 mm)</p> <p>Printer and Stand SD-24 (when the basket is opened): Approx. 46.0 x 57.9 x 54.1 in. (1168 x 1470 x 1374 mm)</p>

Printing performance

Print method	Bubblejet
Maximum resolution	2400 dpi (horizontally) * x 1200 dpi (vertically) * Prints with a minimum 1/2400 inch dot pitch between ink droplets.
Print head	PF-08
Number of nozzles	4352 nozzles (BK: 1280 nozzles, C/M/Y: 1024 nozzles)

Scan Specifications (for TC-20M only)

Scanner driver	Windows: TWAIN 1.9 Specification, WIA
Maximum scanning size	Document Platen: A4/Letter, 8.5 x 11.7 in. (216 x 297 mm)
Optical resolution (horizontal x vertical)	1200 x 2400 dpi * * Optical Resolution represents the maximum sampling rate based on ISO 14473.
Gradation (Input / Output)	Gray: 16 bit/8 bit Color: RGB each 16 bit/8 bit

Memory

Memory	Physical memory 1GB
---------------	---------------------

Interface

USB and the network can be used at the same time.

You cannot use Wi-Fi and wired LAN at the same time.

USB	Hi-Speed USB * * To use Hi-Speed USB, your computer must support Hi-Speed USB. Additionally, the Hi-Speed USB interface is completely backward compatible with USB 1.1, so the printer can be connected even if the computer interface is USB 1.1.
USB memory (TC-20M)	USB flash drive
LAN	Wired LAN: IEEE802.3u (100BASE-TX) / IEEE802.3 (10BASE-T) Wi-Fi: IEEE802.11n / IEEE802.11g / IEEE802.11b

Network Specifications

Communication protocol	SNMP, HTTP, TCP / IP (IPv4 / IPv6)
Wired LAN specifications	Approved standards: IEEE802.3u (100BASE-TX) / IEEE802.3 (10BASE-T)

	<p>Transmission speed: 10 Mbps / 100 Mbps (automatically selected)</p> <p>Security: IEEE802.1X (EAP-TLS / EAP-TTLS / PEAP)</p>
Wi-Fi specifications	<p>Approved standards: IEEE802.11n / IEEE802.11g / IEEE802.11b</p> <p>Frequency range: 2.4 GHz</p> <p>Channels: 1-11 or 1-13 *</p> <p>* Varies by country and region.</p> <p>Effective range: Indoors 164 feet/50 m *</p> <p>* Varies according to environmental conditions.</p> <p>Security:</p> <p>WPA-PSK (TKIP / AES)</p> <p>WPA2-PSK (TKIP / AES)</p> <p>WPA3-SAE (AES)</p> <p>WPA-EAP (AES) *</p> <p>WPA2-EAP (AES) *</p> <p>WPA3-EAP (AES) *</p> <p>* Supports IEEE802.1X (EAP-TLS / EAP-TTLS / PEAP)</p> <p>Setup:</p> <p>WPS (push button method/PIN code method)</p> <p>Easy wireless connect</p>

Operating Conditions

If operating conditions of the operating system are high, follow those.

Windows

Compatible Operating System (Standard supplied printer driver)	<p>Windows 11</p> <p>Windows 10</p> <p>Windows 8.1</p> <p>Windows 7</p> <p>Windows Server 2022</p> <p>Windows Server 2019</p> <p>Windows Server 2016</p> <p>Windows Server 2012 R2</p> <p>Windows Server 2012</p> <p>Windows Server 2008 R2</p> <p>Use the latest Service Pack available.</p>
Free hard disk space	20 GB or more

macOS

Compatible Operating System (Standard supplied printer driver)	macOS Mojave 10.14.6 - macOS Monterey 12
Free hard disk space	20 GB or more

Other Supported OS

iOS, iPadOS, Android, Chrome OS

Some functions may not be available with the supported OS.

- An Internet connection is required to use the Online Manual.
- To install the software while using Windows, you must have a CD-ROM drive or a network connection.
- To install the software while using macOS, you must have a network connection.

Paper

For details on the compatible media types, see Paper Information List.

For details on the paper widths supported by the printer, see [Paper Sizes](#).

For details about Print Area, see [Print Area](#).

Print Area

A margin required by the printer is added with respect to the size of paper loaded in the printer. The actual printing area corresponds to the paper size minus the space for this margin.

▶▶▶ Note

- Printable Area: The area that can be printed.
- To match the document size with the actual printing area, print on oversize paper with the required margin added.
 - ➔ [Printing to Oversized Paper Sizes](#) (Windows)
 - ➔ [Printing to Oversized Paper Sizes](#) (macOS)

Sheets

Printable Area:

A margin of 0.2/1.2 in. (5/30 mm)* on top and bottom edges, and 0.2 in. (5 mm) on left and right edges are required.

* The margins on the sheet vary depending on the paper type and print settings. The bottom margin also depends on the OS and application.

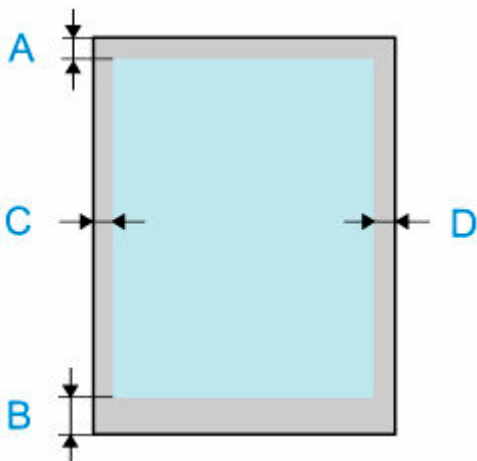

- A: Top Edge
- B: Bottom Edge
- C: Left Edge
- D: Right Edge

Rolls

Printable Area:

A margin of 0.2/1.2 in. (5/30 mm)* on top and bottom edges, 0.2 in. (5 mm) on the left edge, 0.2/0.3 in. (5/7.5 mm)* on the right edge is required.

* The margins on the roll paper vary depending on the paper type and print settings.

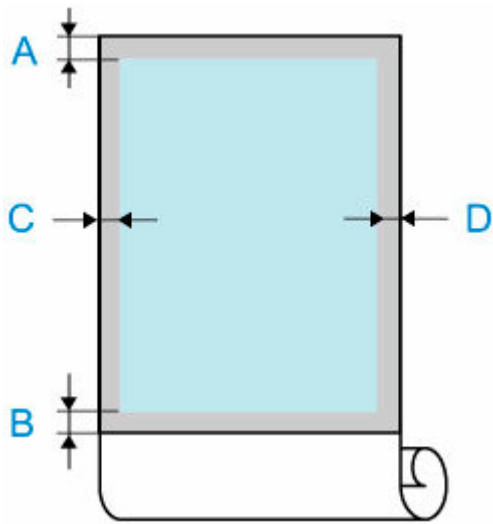

- A: Top Edge
- B: Bottom Edge
- C: Left Edge
- D: Right Edge

Appendix

- **Safety**
- **Handling Precautions**
- **Online Manual**
- **Symbols Used in This Document**
- **Touch-enabled Device Users (Windows)**
- **Printing Online Manual**
- **Trademarks and Licenses**



Safety

- **Safety Precautions**
- **Regulatory Information**
- **WEEE**

Safety Precautions

Follow the items below to use the printer safely. This may cause unexpected accidents such as fire or electrical shock.

Symbols

 Warning	Instructions that, if ignored, could result in death, serious personal injury, or property damage caused by incorrect operation of the equipment are provided. These must be observed for safe operation.
 Caution	Instructions that, if ignored, could result in personal injury or property damage caused by incorrect operation of the equipment are provided. These must be observed for safe operation.

Warning

- **For people who are using a cardiac pacemaker**

This product generates a low-level magnetic field. If you experience discomfort while working around this product, leave the area and consult a doctor.

- **Turn off the power immediately in the following circumstances.**

If you continue to use the printer in the following cases, it may cause fires or electrical shock.

Immediately press the power button to turn off the printer, disconnect the power plug from the outlet, and make a request for repairs.

- If any foreign matter (metal fragments, liquids, etc.) gets inside the printer
- If the printer emits smoke, abnormal odors, or abnormal noises
- If the power cord or any of the cables become hot, corroded, bent, frayed, or damaged

- **Follow the items below as there is a risk of fire and electrical shock.**

- Do not set up the product in any location exposed to alcohol, thinner, or other flammable liquids.
 - Do not disassemble or modify the product.
 - Use the cables that are included with the printer. Do not use the cables included with the printer with other devices.
 - Do not use outside of the designated power supply voltage and frequency.
 - Insert the power plug securely and completely into the power outlet.
 - Never handle the power plug with wet hands.
 - Do not damage, modify, pull, bundle, join, or forcefully bend the power cord or any cables.
 - Never place a heavy object on the power cord or any cables.
 - Do not insert multiple power plugs into the same outlet.
 - Do not connect multiple extension cords.
 - If there is lightning nearby, disconnect the power plug from the outlet and do not use the product.
 - When cleaning, always disconnect the cables and power plug, and do not use highly flammable sprays or liquids such as alcohol or thinner.
 - Once per month, disconnect the power plug and power cord from the outlet, and check that dust has not accumulated, and that there are no abnormalities such as heat generation, rust, bending, chafing, or cracking.
-

Caution

- Never insert your hand into the printer while it is printing.
- Never touch the electrical contacts of the print head by hand immediately after printing.
- The following symbol is displayed around the movable parts of the printer. Take care to avoid touching them with your hand or inserting your finger. Note that this symbol may not appear on your model.



Moving Parts

Keep body parts away from moving parts.

Keep body parts out of the motion path.

• **About Ink Bottles**

- Always store consumables out of the reach of small children.
- **Do not drink ink.**
If a child licks or ingests ink accidentally, wash out their mouth or make them drink 1 or 2 cups of water, and immediately seek medical attention. If ink accidentally gets in your eyes, immediately rinse with water, and immediately seek medical attention.
- If ink gets on your skin, immediately clean it off with soap and water. If irritation persists, immediately seek medical attention.
- When storing ink bottles, securely close the bottle cap of the ink bottle and store in an always upright state. If it falls over, there is a risk of the ink spilling.
- Take great care to avoid ink spraying around when refilling the ink tanks with ink.
- If ink becomes adhered to your clothes or anything you are carrying, you might not be able to wash it out.
- Do not leave in a location that gets hot, such as near a fire, near a heater, or in a vehicle. The container may deform, causing the ink to spill, or the ink quality may become degraded.
- Do not expose ink bottles to impacts. The ink bottle may break or the bottle cap may come off, causing ink to spill.
- Do not pour into a different container. This may cause accidental ingestion or misuse of the ink, or the ink quality may become degraded.
- Do not use for any purpose other than refilling the ink in the printer specified by our company.
- Do not dilute with water, mix with other inks, etc. This may damage the printer.

• **Moving the Printer**

- Have the following number of people carry the printer. The weight may cause pain such as back pain.

TC-20M : 2 people

TC-20 : 2 people



Choosing a location

- Never install the printer on an unstable or vibrating surface.
- Do not install the printer in locations that are very humid or dusty, in direct sunlight, outdoors, or close to a heating source.
To avoid the risk of fire or electric shocks, use the printer under the operating environment specified in the [Specifications](#).
- Do not place the printer on a thick rug or carpet.
- Do not place the printer with its back attached to the wall.
- We recommend ensuring ample space for installation.
- Do not install the printer near sources of strong electromagnetic fields, whether equipment that generates such fields or places where such fields occur.

Power Supply

- Ensure that the area around the power outlet is kept clear at all times so you can easily unplug the power cord if necessary.
- Never remove the plug by pulling on the cord.
Pulling the cord may damage the power cord, leading to possible fire or electrical shock.
- Do not use an extension lead/cord.

Working Around the Printer

- Never put your hands or fingers in the printer while it is printing.
- When using and transferring the printer, do not tilt it, stand it on its side, or turn it upside down. There is a risk of the ink spilling.

Print Heads/Ink Bottle/Maintenance Cartridges

- Keep ink bottle out of the reach of children. In case ink is accidentally licked or swallowed, rinse out mouth or give one or two glasses of water to drink. If irritation or discomfort occurs, obtain medical advice immediately.

- In case ink gets in contact with eyes, rinse with water immediately. In case ink gets in contact with skin, wash with soap and water immediately. If irritation to eyes or skin persists, obtain medical advice immediately.
- Never touch the electrical contacts on a print head after printing.
The metal parts may be very hot and could cause burns.
- Do not throw ink bottle and maintenance cartridges into fire.
- Do not attempt to disassemble or modify the print head, ink bottle, and maintenance cartridges.
- Avoid dropping or shaking print head, ink bottle, and maintenance cartridges.

Regulatory Information

Users in the U.S.A.

FCC Notice (U.S.A. Only)

For 120V, 60Hz model

Model Number: K10560/K10562 (Contains FCC Approved WLAN Module K30387)

This device complies with Part 15 of the FCC Rules. Operation is subject to the following two conditions:

(1) This device may not cause harmful interference, and (2) this device must accept any interference received, including interference that may cause undesired operation.

Note: This equipment has been tested and found to comply with the limits for a Class B digital device, pursuant to Part 15 of the FCC Rules. These limits are designed to provide reasonable protection against harmful interference in a residential installation. This equipment generates, uses and can radiate radio frequency energy and, if not installed and used in accordance with the instructions, may cause harmful interference to radio communications.

However, there is no guarantee that interference will not occur in a particular installation. If this equipment does cause harmful interference to radio or television reception, which can be determined by turning the equipment off and on, the user is encouraged to try to correct the interference by one or more of the following measures:

- Reorient or relocate the receiving antenna.
- Increase the separation between the equipment and receiver.
- Connect the equipment into an outlet on a circuit different from that to which the receiver is connected.
- Consult the dealer or an experienced radio/TV technician for help.

Use of a shielded cable is required to comply with Class B limits in Subpart B of Part 15 of the FCC Rules.

Do not make any changes or modifications to the equipment unless otherwise specified in the manual. If such changes or modifications should be made, you could be required to stop operation of the equipment.

Changes or modifications not expressly approved by the party responsible for compliance could void the user's authority to operate equipment.

This transmitter must not be co-located or operating in conjunction with any other antenna or transmitter.

The equipment complies with FCC radiation exposure limits for uncontrolled equipment. This equipment should be installed and operated with minimum distance at least 20cm between the radiator and persons body (excluding extremities: hands, wrists, feet and ankles) and must not be colocated or operated with any other antenna or transmitter.

Canon U.S.A., Inc.

One Canon Park

Melville, New York 11747

1-800-652-2666

Interference

Do not use the printer around medical equipment or other electronic devices. Signals from the printer may interfere with the correct operation of these devices.

WEEE

Only for the United Kingdom



These symbols indicate that this product is not to be disposed of with your household waste, according to the UK Waste Electrical and Electronic Equipment Regulations and the UK Batteries and Accumulators Regulations. If a chemical symbol is printed beneath the symbol shown above, in accordance with the UK Batteries and Accumulators Regulations, this indicates that a heavy metal (Hg = Mercury, Cd = Cadmium, Pb = Lead) is present in this battery or accumulator at a concentration above an applicable threshold specified in the UK Batteries and Accumulators Regulations. This product should be handed over to a designated collection point, e.g., on an authorized one-for-one basis when you buy a new similar product or to an authorized collection site for recycling waste electrical and electronic equipment (EEE) and batteries and accumulators. Improper handling of this type of waste could have a possible impact on the environment and human health due to potentially hazardous substances that are generally associated with EEE. Your cooperation in the correct disposal of this product will contribute to the effective usage of natural resources. For more information about the recycling of this product, please contact your local city office, waste authority, approved scheme or your household waste disposal service or visit www.canon-europe.com/sustainability/approach/.

Only for European Union and EEA (Norway, Iceland and Liechtenstein)



These symbols indicate that this product is not to be disposed of with your household waste, according to the WEEE Directive (2012/19/EU), the Battery Directive (2006/66/EC) and/or national legislation implementing those Directives. If a chemical symbol is printed beneath the symbol shown above, in accordance with the Battery Directive, this indicates that a heavy metal (Hg = Mercury, Cd = Cadmium, Pb = Lead) is present in this battery or accumulator at a concentration above an applicable threshold specified in the Battery Directive. This product should be handed over to a designated collection point, e.g., on an authorized one-for-one basis when you buy a new similar product or to an authorized collection site for recycling waste electrical and electronic equipment (EEE) and batteries and accumulators. Improper handling of this type of waste could have a possible impact on the environment and human health due to potentially hazardous substances that are generally associated with EEE. Your cooperation in the correct disposal of this product will contribute to the effective usage of natural resources. For more information about the recycling of this product, please contact your local city office, waste authority, approved scheme or your household waste disposal service or visit www.canon-europe.com/weee, or www.canon-europe.com/battery.

Nur für Europäische Union und EWR (Norwegen, Island und Liechtenstein)



Diese Symbole weisen darauf hin, dass dieses Produkt gemäß WEEE-Richtlinie (2012/19/EU; Richtlinie über Elektro- und Elektronik-Altgeräte), Batterien-Richtlinie (2006/66/EG) und nationalen Gesetzen zur Umsetzung dieser Richtlinien nicht über den Hausmüll entsorgt werden darf. Falls sich unter dem oben abgebildeten Symbol ein chemisches Symbol befindet, bedeutet dies gemäß der Batterien-Richtlinie, dass in dieser Batterie oder diesem Akkumulator ein Schwermetall (Hg = Quecksilber, Cd = Cadmium, Pb = Blei) in einer Konzentration vorhanden ist, die über einem in der Batterien-Richtlinie angegebenen Grenzwert liegt. Dieses Produkt muss bei einer dafür vorgesehenen Sammelstelle abgegeben werden. Dies kann z. B. durch Rückgabe beim Kauf eines neuen ähnlichen Produkts oder durch Abgabe bei einer autorisierten Sammelstelle für die Wiederaufbereitung von Elektro- und Elektronik-Altgeräten sowie Batterien und Akkumulatoren geschehen. Der unsachgemäße Umgang mit Altgeräten kann aufgrund potenziell gefährlicher Stoffe, die generell mit Elektro- und Elektronik-Altgeräten in Verbindung stehen, negative Auswirkungen auf die Umwelt und die menschliche Gesundheit haben. Durch Ihre Mitarbeit bei der umweltgerechten Entsorgung dieses Produkts tragen Sie zu einer effektiven Nutzung natürlicher Ressourcen bei. Um weitere Informationen über die Wiederverwertung dieses Produkts zu erhalten, wenden Sie sich an Ihre Stadtverwaltung, den öffentlich-rechtlichen Entsorgungsträger, eine autorisierte Stelle für die Entsorgung von Elektro- und Elektronik-Altgeräten oder Ihr örtliches Entsorgungsunternehmen oder besuchen Sie www.canon-europe.com/weee, oder www.canon-europe.com/battery.

Zusatzinformationen für Deutschland:

Dieses Produkt kann durch Rückgabe an den Händler unter den in der Verordnung des Elektro- und Elektronikgerätegesetzes beschriebenen Bedingungen abgegeben werden.

Als Endbenutzer und Besitzer von Elektro- oder Elektronikgeräten sind Sie verpflichtet:

- diese einer vom unsortierten Siedlungsabfall getrennten Erfassung zuzuführen,
- Altbatterien und Altkumulatoren, die nicht vom Altgerät umschlossen sind, sowie Lampen, die zerstörungsfrei aus dem Altgerät entnommen werden können, vor der Abgabe an einer Erfassungsstelle vom Altgerät zerstörungsfrei zu trennen,
- personenbezogener Daten auf den Altgeräten vor der Entsorgung zu löschen. Die Bedeutung von dem Symbol der durchgestrichenen Abfalltonne auf Rädern finden Sie oben in dieser Beschreibung.

Die Vertreiber von Elektro- oder Elektronikgeräten haben die Pflicht zur unentgeltlichen Rücknahme von Altgeräten. Die Vertreiber haben die Endnutzer über die von ihnen geschaffenen Möglichkeiten der Rückgabe von Altgeräten zu informieren.

Union Européenne, Norvège, Islande et Liechtenstein uniquement.



Ces symboles indiquent que ce produit ne doit pas être mis au rebut avec les ordures ménagères, comme le spécifient la Directive européenne DEEE (2012/19/UE), la Directive européenne relative à l'élimination

des piles et des accumulateurs usagés (2006/66/CE) et les lois en vigueur dans votre pays appliquant ces directives. Si un symbole de toxicité chimique est imprimé sous le symbole illustré ci-dessus conformément à la Directive relative aux piles et aux accumulateurs, il indique la présence d'un métal lourd (Hg = mercure, Cd = cadmium, Pb = plomb) dans la pile ou l'accumulateur à une concentration supérieure au seuil applicable spécifié par la Directive. Ce produit doit être confié au distributeur à chaque fois que vous achetez un produit neuf similaire, ou à un point de collecte mis en place par les collectivités locales pour le recyclage des Déchets des Équipements Électriques et Électroniques (DEEE). Le traitement inapproprié de ce type de déchet risque d'avoir des répercussions sur l'environnement et la santé humaine, du fait de la présence de substances potentiellement dangereuses généralement associées aux équipements électriques et électroniques. Votre entière coopération dans le cadre de la mise au rebut correcte de ce produit favorisera une meilleure utilisation des ressources naturelles. Pour plus d'informations sur le recyclage de ce produit, contactez vos services municipaux, votre éco-organisme ou les autorités locales compétentes, ou consultez le site www.canon-europe.com/weee, ou www.canon-europe.com/battery.

Uitsluitend bestemd voor de Europese Unie en EER (Noorwegen, IJsland en Liechtenstein)



Met deze symbolen wordt aangegeven dat dit product in overeenstemming met de AEEA-richtlijn (2012/19/EU), de richtlijn 2006/66/EG betreffende batterijen en accu's en/of de plaatselijk geldende wetgeving waarin deze richtlijnen zijn geïmplementeerd, niet bij het normale huisvuil mag worden weggegooid. Indien onder het hierboven getoonde symbool een chemisch symbool gedrukt staat, geeft dit in overeenstemming met de richtlijn betreffende batterijen en accu's aan dat deze batterij of accu een zwaar metaal bevat (Hg = kwik, Cd = cadmium, Pb = lood) waarvan de concentratie de toepasselijke drempelwaarde in overeenstemming met de genoemde richtlijn overschrijdt. Dit product dient te worden ingeleverd bij een hiervoor aangewezen inzamelpunt, bijv. door dit in te leveren bij een hiertoe erkend verkooppunt bij aankoop van een gelijksoortig product, of bij een officiële inzameldienst voor de recycling van elektrische en elektronische apparatuur (EEA) en batterijen en accu's. Door de potentieel gevaarlijke stoffen die gewoonlijk gepaard gaan met EEA, kan onjuiste verwerking van dit type afval mogelijk nadelige gevolgen hebben voor het milieu en de menselijke gezondheid. Uw medewerking bij het op juiste wijze weggooien van dit product draagt bij tot effectief gebruik van natuurlijke hulpbronnen. Voor verdere informatie over recycling van dit product kunt u contact opnemen met uw plaatselijke gemeente, afvaldienst, officiële dienst voor klein chemisch afval of afvalstortplaats, of kunt u terecht op www.canon-europe.com/weee, of www.canon-europe.com/battery.

Sólo para la Unión Europea y el Área Económica Europea (Noruega, Islandia y Liechtenstein)



Estos iconos indican que este producto no debe desecharse con los residuos domésticos de acuerdo con la Directiva sobre RAEE (2012/19/UE) y la Directiva sobre Pilas y Acumuladores (2006/66/CE) y/o la legislación nacional. Si aparece un símbolo químico bajo este icono, de acuerdo con la Directiva sobre Pilas y Acumuladores, significa que la pila o el acumulador contiene metales pesados (Hg = Mercurio, Cd = Cadmio, Pb = Plomo) en una concentración superior al límite especificado en dicha directiva. Este producto deberá entregarse en un punto de recogida designado, por ejemplo, entregándolo en el lugar de venta al adquirir un producto nuevo similar o en un centro autorizado para la recogida de residuos de aparatos eléctricos y electrónicos (RAEE), baterías y acumuladores. La gestión incorrecta de este tipo de residuos puede afectar al medio ambiente y a la salud humana debido a las sustancias potencialmente nocivas que suelen contener estos aparatos. Su cooperación en la correcta eliminación de este producto contribuirá al correcto aprovechamiento de los recursos naturales. Los usuarios tienen derecho a devolver pilas, acumuladores o baterías usados sin coste alguno. El precio de venta de pilas, acumuladores y baterías incluye el coste de la gestión medioambiental de su desecho, y no es necesario mostrar la cuantía de dicho coste en la información y la factura suministradas a los usuarios finales. Si desea más información sobre el reciclado de este producto, póngase en contacto con su municipio, el servicio o el organismo encargado de la gestión de residuos domésticos o visite www.canon-europe.com/weee, o www.canon-europe.com/battery.

Només per a la Unió Europea i a l'Espai Econòmic Europeu (Noruega, Islàndia i Liechtenstein)



Aquests símbols indiquen que aquest producte no s'ha de llençar amb les escombraries de la llar, d'acord amb la RAEE (2012/19/UE), la Directiva relativa a piles i acumuladors (2006/66/CE) i la legislació nacional que implementi aquestes directives. Si al costat d'aquest símbol hi apareix imprès un símbol químic, segons especifica la Directiva relativa a piles i acumuladors, significa que la bateria o l'acumulador conté un metall pesant (Hg = mercuri, Cd = cadmi, Pb = plom) en una concentració superior al límit aplicable especificat en la Directiva. Aquest producte s'hauria de lliurar en un dels punts de recollida designats, com per exemple, intercanviant un per un en comprar un producte similar o lliurant-lo en un lloc de recollida autoritzat per al reciclatge de residus d'aparells elèctrics i electrònics (RAEE) i piles i acumuladors. La manipulació inadequada d'aquest tipus de residus podria tenir un impacte negatiu en l'entorn i en la salut humana, a causa de les substàncies potencialment perilloses que normalment estan associades a l'RAEE. La vostra cooperació a l'hora de rebutjar correctament aquest producte contribuirà a la utilització efectiva dels recursos naturals. Els usuaris tenen dret a retornar les bateries o els acumuladors usats sense cap càrrec. El preu de venda de les bateries i els acumuladors inclou el cost de la gestió ambiental dels residus i no es necessari mostrar l'import d'aquest cost en aquest fulllet o en la factura que es lliuri a l'usuari final. Per a més informació sobre el reciclatge d'aquest producte, contacteu amb l'oficina municipal, les autoritats encarregades dels residus, el pla de residus homologat o el servei de recollida d'escombraries domèstiques de la vostra localitat o visiteu www.canon-europe.com/weee, o www.canon-europe.com/battery.

Solo per Unione Europea e SEE (Norvegia, Islanda e Liechtenstein)



Questi simboli indicano che il prodotto non può essere smaltito con i rifiuti domestici, ai sensi della Direttiva RAEE (2012/19/UE), della Direttiva sulle Batterie (2006/66/CE) e/o delle leggi nazionali che attuano tali Direttive. Se sotto il simbolo indicato sopra è riportato un simbolo chimico, in osservanza della Direttiva sulle batterie, tale simbolo indica la presenza di un metallo pesante (Hg = Mercurio, Cd = Cadmio, Pb = Piombo) nella batteria o nell'accumulatore con un livello di concentrazione superiore a una soglia applicabile specificata nella Direttiva sulle batterie. Il prodotto deve essere conferito a un punto di raccolta designato, ad esempio il rivenditore in caso di acquisto di un nuovo prodotto simile oppure un centro di raccolta autorizzato per il riciclaggio di rifiuti di apparecchiature elettriche ed elettroniche (RAEE) nonché di batterie e accumulatori. Un trattamento improprio di questo tipo di rifiuti può avere conseguenze negative sull'ambiente e sulla salute umana a causa delle sostanze potenzialmente nocive solitamente contenute in tali rifiuti. La collaborazione dell'utente per il corretto smaltimento di questo prodotto contribuirà a un utilizzo efficace delle risorse naturali ed eviterà di incorrere in sanzioni amministrative ai sensi dell'art. 255 e successivi del Decreto Legislativo n. 152/06. Per ulteriori informazioni sul riciclaggio di questo prodotto, contattare le autorità locali, l'ente responsabile della raccolta dei rifiuti, un rivenditore autorizzato o il servizio di raccolta dei rifiuti domestici, oppure visitare il sito www.canon-europe.com/weee, o www.canon-europe.com/battery.

Apenas para a União Europeia e AEE (Noruega, Islândia e Liechtenstein)



Estes símbolos indicam que este produto não deve ser eliminado juntamente com o seu lixo doméstico, segundo a Diretiva REEE de 2012/19/UE, a Diretiva de Baterias (2006/66/CE) e/ou a sua legislação nacional que transponha estas Diretivas. Se houver um símbolo químico impresso como mostrado abaixo, de acordo com a Diretiva de Baterias, isto indica que um metal pesado (Hg = Mercúrio, Cd = Cádmiio, Pb = Chumbo) está presente nesta pilha ou acumulador, numa concentração acima de um limite aplicável especificado na Diretiva. Este produto deve ser entregue num ponto de recolha designado, por exemplo num local autorizado de troca quando compra um equipamento novo idêntico, ou num local de recolha autorizado para reciclar equipamento elétrico e eletrónico (EEE) em fim de vida, bem como pilhas e baterias. O tratamento inadequado deste tipo de resíduos pode ter um impacto negativo no ambiente e na saúde humana, devido a substâncias potencialmente perigosas que estão associadas com equipamentos do tipo EEE. A sua cooperação no tratamento correto deste produto irá contribuir para a utilização mais eficaz dos recursos naturais. Para obter mais informações acerca de como reciclar este produto, por favor contacte as suas autoridades locais responsáveis pela matéria, serviço de recolha aprovado para pilhas e baterias ou serviço de recolha de resíduos sólidos domésticos da sua municipalidade, ou visite www.canon-europe.com/weee, ou www.canon-europe.com/battery.

Gælder kun i Europæiske Union og EØS (Norge, Island og Liechtenstein)



Disse symboler betyder, at produktet ikke må bortskaffes sammen med dagrenovation i henhold til WEEE-direktivet (2012/19/EU), batteridirektivet (2006/66/EF) og/eller den lokale lovgivning, som disse direktiver er gennemført i. Hvis der i overensstemmelse med batteridirektivet er trykt et kemisk symbol under det symbol, der er vist ovenfor, betyder det, at batteriet eller akkumulatoren indeholder tungmetaller (Hg = kviksølv, Cd = cadmium, Pb = bly) i en koncentration, som ligger over de grænseværdier, der er beskrevet i batteridirektivet. Produktet skal afleveres på et godkendt indsamlingssted, f.eks. i overensstemmelse med en godkendt én-til-én-procedure, når du indkøber et nyt tilsvarende produkt, eller på et godkendt indsamlingssted for elektronikaffald samt for batterier og akkumulatore. Forkert håndtering af denne type affald kan medføre negative konsekvenser for miljøet og menneskers helbred på grund af de potentielt sundhedsskadelige stoffer, der generelt kan forefindes i elektrisk og elektronisk udstyr. Når du foretager korrekt bortskaffelse af produktet, bidrager du til effektiv brug af naturressourcerne. Kontakt din kommune, den lokale affaldsmyndighed, det lokale affaldsanlæg, eller besøg www.canon-europe.com/weee, eller www.canon-europe.com/battery for at få flere oplysninger om genbrug af dette produkt.

Μόνο για την Ευρωπαϊκή Ένωση και τον ΕΟΧ (Νορβηγία, Ισλανδία και Λιχτενστάιν)



Αυτά τα σύμβολα υποδεικνύουν ότι αυτό το προϊόν δεν πρέπει να απορρίπτεται μαζί με τα οικιακά απορρίμματα, σύμφωνα με την Οδηγία για τα Απόβλητα Ηλεκτρικού και Ηλεκτρονικού Εξοπλισμού (ΑΗΗΕ) (2012/19/ΕΕ), την Οδηγία για τις Ηλεκτρικές Στήλες (2006/66/ΕΚ) ή/και την εθνική νομοθεσία που εφαρμόζει τις Οδηγίες εκείνες. Εάν κάποιο χημικό σύμβολο είναι τυπωμένο κάτω από το σύμβολο που φαίνεται παραπάνω, σύμφωνα με την Οδηγία για τις Ηλεκτρικές Στήλες, υποδηλώνει ότι κάποιο βαρύ μέταλλο (Hg = Υδράργυρος, Cd = Κάδμιο, Pb = Μόλυβδος) υπάρχει στην μπαταρία ή τον συσσωρευτή σε συγκέντρωση μεγαλύτερη από το ισχύον επίπεδο που καθορίζεται στην Οδηγία για τις Ηλεκτρικές Στήλες. Αυτό το προϊόν πρέπει να παραδίδεται σε καθορισμένο σημείο συλλογής, π.χ. σε μια εξουσιοδοτημένη βάση ανταλλαγής όταν αγοράζετε ένα νέο παρόμοιο προϊόν ή σε μια εξουσιοδοτημένη θέση συλλογής για την ανακύκλωση των αποβλήτων ηλεκτρικού και ηλεκτρονικού εξοπλισμού (ΗΗΕ) και των ηλεκτρικών στηλών και συσσωρευτών. Ο ακατάλληλος χειρισμός αυτού του τύπου αποβλήτων μπορεί να έχει αρνητικό αντίκτυπο στο περιβάλλον και την υγεία του ανθρώπου, λόγω δυνητικά επικίνδυνων ουσιών που γενικά συνδέονται με τον ΗΗΕ. Η συνεργασία σας για τη σωστή απόρριψη αυτού του προϊόντος θα συμβάλει στην αποτελεσματική χρήση των φυσικών πόρων. Για περισσότερες πληροφορίες σχετικά με ανακύκλωση αυτού του προϊόντος, επικοινωνήστε με το τοπικό γραφείο της πόλης σας, την υπηρεσία απορριμμάτων, το εγκεκριμένο σχήμα ή την υπηρεσία απόρριψης οικιακών αποβλήτων ή επισκεφθείτε τη διεύθυνση www.canon-europe.com/weee ή www.canon-europe.com/battery.

Gjelder kun den europeiske union og EØS (Norge, Island og Liechtenstein)



Disse symbolene indikerer at dette produktet ikke skal kastes sammen med husholdningsavfall, i henhold til WEEE-direktivet (2012/19/EU), batteridirektivet (2006/66/EF) og/eller nasjonal lov som har implementert disse direktivene. Hvis et kjemisk symbol vises under symbolet vist ovenfor, i samsvar med batteridirektivet, indikerer dette at et tungmetall (Hg = kvikksølv, Cd = kadmium, Pb = bly) finnes i batteriet eller akkumulatoren i en konsentrasjon over en gjeldende øvre grense som er spesifisert i batteridirektivet. Produktet må leveres til et dertil egnet innsamlingspunkt, det vil si på en autorisert en-til-en-basis når en kjøper et nytt lignende produkt, eller til et autorisert innsamlingssted for resirkulering av avfall fra elektrisk og elektronisk utstyr (EE-utstyr) og batterier og akkumulatører. Feil håndtering av denne typen avfall kan være miljø- og helseskadelig på grunn av potensielt skadelige stoffer som ofte brukes i EE-utstyr. Din innsats for korrekt avhending av produktet vil bidra til effektiv bruk av naturressurser. Du kan få mer informasjon om resirkulering av dette produktet ved å kontakte lokale myndigheter, avfallsadministrasjonen, et godkjent program eller husholdningens renovasjonsselskap, eller gå til www.canon-europe.com/weee, eller www.canon-europe.com/battery.

Vain Euroopan unionin sekä ETA:n (Norja, Islanti ja Liechtenstein) alueelle.



Nämä tunnukset osoittavat, että sähkö- ja elektroniikkalaiteromua koskeva direktiivi (SER-direktiivi, 2012/19/EU), paristoista ja akuista annettu direktiivi (2006/66/EY) sekä kansallinen lainsäädäntö kieltävät tuotteen hävittämisen talousjätteen mukana. Jos yllä olevan symbolin alapuolelle on paristodirektiivin mukaisesti painettu kemiallisen aineen tunnus, kyseinen paristo tai akku sisältää raskasmetalleja (Hg = elohopea, Cd = kadmium, Pb = lyijy) enemmän kuin paristodirektiivin salliman määrän. Tuote on vietävä asianmukaiseen keräyspisteeseen, esimerkiksi kodinkoneliikkeeseen uutta vastaavaa tuotetta ostettaessa tai viralliseen sähkö- ja elektroniikkalaiteromun tai paristojen ja akkujen keräyspisteeseen. Sähkö- ja elektroniikkalaiteromun virheellinen käsittely voi vahingoittaa ympäristöä ja ihmisten terveyttä, koska laitteet saattavat sisältää ympäristölle ja terveydelle haitallisia aineita. Tuotteen asianmukainen hävittäminen säästää myös luonnonvaroja. Jos haluat lisätietoja tämän tuotteen kierrätyksestä, ota yhteys kunnan jätehuoltoviranomaisiin tai käyttämäsi jätehuoltoyhtiöön tai käy osoitteessa www.canon-europe.com/weee, tai www.canon-europe.com/battery.

Endast för Europeiska unionen och EES (Norge, Island och Liechtenstein)



De här symbolerna visar att produkten inte får sorteras och slängas som hushållsavfall enligt WEEE-direktivet (2012/19/EU), batteridirektivet (2006/66/EG) och/eller nationell lagstiftning som implementerar dessa direktiv. Om en kemisk symbol förekommer under ovanstående symbol innebär detta enligt Batteridirektivet att en tungmetall (Hg = Kvicksilver, Cd = Kadmium, Pb = Bly) förekommer i batteriet eller ackumulatorn med en koncentration som överstiger tillämplig gräns som anges i Batteridirektivet. Produkten ska lämnas in på en avsedd insamlingsplats, t.ex. på en återvinningsstation auktoriserad att hantera elektrisk och elektronisk utrustning (EE-utrustning) samt batterier och ackumulatörer eller hos handlare som är auktoriserade att byta in varor då nya, motsvarande köps (en mot en). Olämplig hantering av avfall av den här typen kan ha negativ inverkan på miljön och människors hälsa på grund av de potentiellt farliga ämnen som kan återfinnas i elektrisk och elektronisk utrustning. Din medverkan till en korrekt avfallshantering av produkten bidrar till effektiv användning av naturresurserna. Om du vill ha mer information om var du kan lämna in den här produkten, kontakta ditt lokala kommunkontor, berörd myndighet eller företag för avfallshantering eller se www.canon-europe.com/weee, eller www.canon-europe.com/battery.

Pouze Evropská unie a EHP (Norsko, Island a Lichtenštejsko)



Tento symbol znamená, že podle směrnice OEEZ (2012/19/EU), směrnice o bateriích (2006/66/ES) a/ nebo podle vnitrostátních právních prováděcích předpisů k těmto směrnici nemá být tento výrobek likvidován s odpadem z domácností. Je-li v souladu s požadavky směrnice o bateriích vytištěna pod výše uvedeným symbolem chemická značka, udává, že tato baterie nebo akumulátor obsahuje těžké kovy (Hg = rtuť, Cd = kadmium, Pb = olovo) v koncentraci vyšší, než je příslušná hodnota předepsaná směrnicí. Tento výrobek má být vrácen do určeného sběrného místa, např. v rámci autorizovaného systému odběru jednoho výrobku za jeden nově prodaný podobný výrobek, nebo do autorizovaného sběrného místa pro recyklaci odpadních elektrických a elektronických zařízení (OEEZ), baterií a akumulátorů. Nevhodné nakládání s tímto druhem odpadu by mohlo mít negativní dopad na životní prostředí a lidské zdraví, protože elektrická a elektronická zařízení zpravidla obsahují potenciálně nebezpečné látky. Vaše spolupráce na správné likvidaci tohoto výrobku napomůže efektivnímu využívání přírodních zdrojů. Chcete-li získat podrobné informace týkající se recyklace tohoto výrobku, obraťte se prosím na místní úřad, orgán pro nakládání s odpady, schválený systém nakládání s odpady či společnost zajišťující likvidaci domovního odpadu, nebo navštivte webové stránky www.canon-europe.com/weee nebo www.canon-europe.com/battery.

Csak az Európai Unió és az EGT (Norvégia, Izland és Liechtenstein) országáiban



Ezek a szimbólumok azt jelzik, hogy a termék hulladékkezelése a háztartási hulladéktól különválasztva, az elektromos és elektronikus berendezések hulladékairól (WEEE) szóló (2012/19/EU) irányelvnek és az elemekről és akkumulátorokról, valamint a hulladék elemekről és akkumulátorokról szóló (2006/66/EK)

irányelvnek megfelelően és/vagy ezen irányelveknek megfelelő helyi előírások szerint történik. Amennyiben a fent feltüntetett szimbólum alatt egy vegyjel is szerepel, az elemekről és akkumulátorokról szóló irányelvben foglaltak értelmében ez azt jelzi, hogy az elem vagy az akkumulátor az irányelvben meghatározott határértéknél nagyobb mennyiségben tartalmaz nehézfémeket (Hg = higany, Cd = kadmium, Pb = ólom). E terméket az arra kijelölt gyűjtőhelyre kell juttatni – pl. hasonló termék vásárlásakor a régi becserélésére vonatkozó hivatalos program keretében, vagy az elektromos és elektronikus berendezések (EEE) hulladékainak gyűjtésére, valamint a hulladék elemek és hulladék akkumulátorok gyűjtésére kijelölt hivatalos gyűjtőhelyre. Az ilyen jellegű hulladékok nem előírászerű kezelése az elektromos és elektronikus berendezésekhez (EEE) általánosan kapcsolható potenciálisan veszélyes anyagok révén hatással lehet a környezetre és az egészségre. E termék megfelelő leselejtezésével Ön is hozzájárul a természeti források hatékony használatához. A termék újrahasznosítását illetően informálódjon a helyi polgármesteri hivatalnál, a helyi közterület-fenntartó vállalatnál, a hivatalos hulladéklerakó telephelyen vagy a háztartási hulladék begyűjtését végző szolgáltatónál, illetve látogasson el a www.canon-europe.com/weee, vagy www.canon-europe.com/battery internetes oldalra.

Tylko dla krajów Unii Europejskiej oraz EOG (Norwegia, Islandia i Liechtenstein)



Te symbole oznaczają, że produktu nie należy wyrzucać razem z odpadami gospodarstwa domowego, zgodnie z dyrektywą WEEE w sprawie zużytego sprzętu elektrycznego i elektronicznego (2012/19/UE) lub dyrektywą w sprawie baterii (2006/66/WE) bądź przepisami krajowymi wdrażającymi te dyrektywy. Jeśli pod powyższym symbolem znajduje się symbol chemiczny, zgodnie z dyrektywą w sprawie baterii oznacza to, że bateria lub akumulator zawiera metal ciężki (Hg = rtęć, Cd = kadm, Pb = ołów) w stężeniu przekraczającym odpowiedni poziom określony w dyrektywie w sprawie baterii. Użytkownicy baterii i akumulatorów mają obowiązek korzystać z dostępnego programu zwrotu, recyklingu i utylizacji baterii oraz akumulatorów. Niewłaściwe postępowanie z tego typu odpadami może mieć wpływ na środowisko i zdrowie ludzi ze względu na substancje potencjalnie niebezpieczne, związane ze użytym sprzętem elektrycznym i elektronicznym. Państwa współpraca w zakresie właściwej utylizacji tego produktu przyczyni się do efektywnego wykorzystania zasobów naturalnych. W celu uzyskania informacji o sposobie recyklingu tego produktu prosimy o kontakt z właściwym urzędem miejskim lub zakładem gospodarki komunalnej bądź zapraszamy na stronę www.canon-europe.com/weee, lub www.canon-europe.com/battery.

Platí len pre štáty Európskej únie a EHP (Nórsko, Island a Lichtenštajnsko)



Tieto symboly označujú, že podľa Smernice o odpade z elektrických a elektronických zariadení (OEEZ) 2012/19/EÚ, Smernice o batériách (2006/66/ES) a podľa platnej legislatívy Slovenskej republiky sa tento produkt nesmie likvidovať spolu s komunálnym odpadom. Ak je chemická značka vytlačená pod vyššie

üvedeným symbolom, znamená to, že táto batéria alebo akumulátor obsahuje ťažký kov (Hg = ortuť, Cd = kadmium, Pb = olovo) v koncentrácii vyššej, ako je príslušná povolená hodnota stanovená v Smernici o batériách. Produkt je potrebné odovzdať do určenej zberne, napr. prostredníctvom výmeny za kúpu nového podobného produktu, alebo na autorizované zberné miesto, ktoré spracúva odpad z elektrických a elektronických zariadení (EEZ), batérií a akumulátorov. Nesprávna manipulácia s takýmto typom odpadu môže mať negatívny vplyv na životné prostredie a ľudské zdravie, pretože elektrické a elektronické zariadenia obsahujú potenciálne nebezpečné látky. Spoluprácou na správnej likvidácii tohto produktu prispějete k účinnému využívaniu prírodných zdrojov. Ďalšie informácie o recyklácii tohto produktu získate od miestneho úradu, úradu životného prostredia, zo schváleného plánu OEEZ alebo od spoločnosti, ktorá zaisťuje likvidáciu komunálneho odpadu. Viac informácií nájdete aj na webovej stránke: www.canon-europe.com/weee, alebo www.canon-europe.com/battery.

Üksnes Euroopa Liit ja EMP (Norra, Island ja Liechtenstein)



Antud sümbolid viitavad sellele, et vastavalt elektri- ja elektroonikaseadmete jäätmeid käsitlevale direktiivile (2012/19/EL), patareisid ja akusid ning patarei- ja akujäätmeid käsitlevale direktiivile (2006/66/EÜ) ja/või nimetatud direktiive rakendavatele riiklikele õigusaktidele ei või seda toodet koos olmejäätmetega ära visata. Kui keemiline sümbol on trükitud eespool toodud sümboli alla, siis tähendab see, et antud patareis või akus leiduva raskemetalli (Hg = elavhõbe, Cd = kaadmium, Pb = plii) kontsentratsioonitase on kõrgem kui patareisid ja akusid ning patarei- ja akujäätmeid käsitlevas direktiivis sätestatud piirmäär. Antud tootest tekkinud jäätmed tuleb anda vastavasse kogumispunkti, nt müügipunkti, mis on volitatud üks ühe vastu vahetama, kui ostate uue sarnase toote, või vastavasse elektri- ja elektroonikaseadmete jäätmete ning patareide ja akude ümbertöötlemiseks mõeldud kogumispunkti. Antud liiki jäätmete vale käitlemine võib kahjustada keskkonda ja inimeste tervist elektri- ja elektroonikajäätmetes tavaliselt leiduvate potentsiaalselt ohtlike ainete tõttu. Antud tootest tekkinud jäätmete nõuetekohase kõrvaldamisega aitate kasutada loodusvarasid efektiivselt. Täiendava teabe saamiseks elektri- ja elektroonikaseadmetest tekkinud jäätmete ning patarei- ja akujäätmete tagastamise ja ümbertöötlemise kohta võtke ühendust kohaliku omavalitsusega, asjakohase valitsusasutusega, asjakohase tootjavastutusorganisatsiooniga või olmejäätmete käitlejaga. Lisateavet leitate ka Interneti-leheküljelt www.canon-europe.com/weee või www.canon-europe.com/battery.

Tikai Eiropas Savienībai un EEZ (Norvēģijai, Islandei un Lihtenšteinai)



Šie simboli norāda, ka atbilstoši ES Direktīvai (2012/19/ES) par elektrisko un elektronisko iekārtu atkritumiem (EEIA), Direktīvai (2006/66/EK) par baterijām un akumulatoriem, un akumulatoru atkritumiem, ar ko atceļ Direktīvu 91/157/EEK, un vietējiem tiesību aktiem šo izstrādājumu nedrīkst izmest kopā ar sadzīves atkritumiem. Ja zem iepriekš norādītā simbola ir uzdrukāts ķīmiskais simbols, saskaņā ar direktīvu par baterijām un akumulatoriem tas nozīmē, ka šīs baterijas vai akumulatori satur smagos metālus (Hg = dzīvsudrabs, Cd = kadmījs, Pb = svins) un to koncentrācijas līmenis pārsniedz direktīvā

par baterijām un akumulatoriem minēto piemērojamo sliekšni. Šis izstrādājums ir jānodod piemērotā savākšanas vietā, piemēram, apstiprinātā veikalā, kur iegādājaties līdzīgu jaunu produktu un atstājat veco, vai apstiprinātā vietā izlietotu elektrisko un elektronisko iekārtu un bateriju un akumulatoru pārstrādei. Nepareiza šāda veida atkritumu apsaimniekošana var apdraudēt vidi un cilvēka veselību tādu iespējami bīstamu vielu dēļ, kas parasti ir elektriskajās un elektroniskajās iekārtās. Jūsu atbalsts pareizā šāda veida atkritumu apsaimniekošanā sekmēs efektīvu dabas resursu izmantošanu. Lai saņemtu pilnīgāku informāciju par šāda veida izstrādājumu nodošanu otrreizējai pārstrādei, sazinieties ar vietējo pašvaldību, atkritumu savākšanas atbildīgo dienestu, pilnvaroto organizāciju vai iestādi, kas veic sadzīves atkritumu apsaimniekošanu, vai apmeklējiet tīmekļa vietni www.canon-europe.com/weee, vai www.canon-europe.com/battery.

Tik Eiropas Savienībai ir EEE (Norvegijai, Islandijai ir Lichtenšteinai)



Šie simboli reiškia, ka šis gaminio negalima išmesti į buitines atliekas, kaip reikalaujama WEEE Direktyvoje (2012/19/ES) ir Baterijų direktyvoje (2006/66/EB) ir (ar) jūsų šalies nacionaliniuose įstatymuose, kuriais šios Direktyvos yra įgyvendinamos. Jeigu cheminio ženklo simbolis yra nurodytas žemiau šio ženklo, tai reiškia, kad vadovaujantis Baterijų direktyvą, baterijų ar akumuliatorių sudėtyje yra sunkiųjų metalų (Hg = gyvsidabris, Cd = kadmio, Pb = švino), kurių koncentracija viršija Baterijų direktyvoje nurodytas leistinas ribas. Šį gaminį reikia pristatyti į specialųjį surinkimo punktą, pavyzdžiui, mainais, kai jūs perkate naują panašų gaminį, arba į specialiąją surinkimo vietą, kurioje perdirbamos elektrinės ir elektroninės įrangos atliekos bei naudotos baterijos ir akumuliatoriai. Dėl netinkamo šio tipo atliekų tvarkymo gali nukentėti aplinka ir iškilti grėsmė žmogaus sveikatai dėl galimai kenksmingų medžiagų, iš esmės susijusių su elektrine ir elektronine įranga. Bendradarbiaudami ir teisingai utilizuodami šiuos gaminius, jūs padėsite efektyviai naudoti gamtinius išteklius. Daugiau informacijos apie gaminio perdirbimą jums gali suteikti vietinis biuras, atliekų tvarkymo bendrovė, sertifikuoti organai ar buitinių atliekų surinkimo įmonės. Taip pat siūloma apsilankyti interneto svetainėje www.canon-europe.com/weee, arba www.canon-europe.com/battery.

Samo za Evropsko unijo in EGP (Norveška, Islandija in Lihtenštajn)



Ti simboli pomenijo, da tega izdelka skladno z Direktivo OEEO (2012/19/EU), Direktivo 2006/66/ES in/ali nacionalno zakonodajo, ki uvaja ti direktivi, ne smete odlagati z nesortiranimi gospodinjskimi odpadki. Če je pod zgoraj prikazanim simbolom natisnjen kemijski simbol, to v skladu z Direktivo pomeni, da je v tej bateriji ali akumulatorju prisotna težka kovina (Hg = živo srebro, Cd = kadmij, Pb = svinec), in sicer v koncentraciji, ki je nad relevantno mejno vrednostjo, določeno v Direktivi. Ta izdelek je potrebno odnesti na izbrano zbirno mesto, t. j. pooblaščen trgovino, kjer ob nakupu novega (podobnega) izdelka vrnete starega, ali na pooblaščen zbirno mesto za ponovno uporabo odpadne električne in elektronske opreme (EEO) ter baterij in akumulatorjev. Neustrezno ravnanje s to vrsto odpadkov lahko negativno vpliva na okolje in človeško zdravje zaradi potencialno nevarnih snovi, ki so pogosto povezane z EEO.

Vaše sodelovanje pri pravilnem odlaganju tega izdelka predstavlja pomemben prispevek k smotni izrabi naravnih virov. Za več informacij o ponovni uporabi tega izdelka se obrnite na lokalni mestni urad, pristojno službo za odpadke, predstavnika pooblaščenega programa za obdelavo odpadkov ali na lokalno komunalno. Lahko pa tudi obiščete našo spletno stran www.canon-europe.com/weee, ali www.canon-europe.com/battery.

Само за Европейския съюз и ЕИП (Норвегия, Исландия и Лихтенщайн)



Тези символи показват, че този продукт не трябва да се изхвърля заедно с битовите отпадъци съгласно Директивата за ИУЕЕО (2012/19/ЕС), Директивата за батерии (2006/66/ЕО) и/или Вашето национално законодателство, прилагащо тези Директиви. Ако под показания горе символ е отпечатан символ за химически елемент, съгласно разпоредбите на Директивата за батерии, този втори символ означава наличието на тежък метал (Hg = живак, Cd = кадмий, Pb = олово) в батерията или акумулатора в концентрация над указаната граница за съответния елемент в Директивата. Този продукт трябва да бъде предаден в предназначен за целта пункт за събиране, например на база размяна, когато купувате нов подобен продукт, или в одобрен събирателен пункт за рециклиране на излязло от употреба електрическо и електронно оборудване (ИУЕЕО), батерии и акумулатори. Неправилното третиране на този тип отпадъци може да доведе до евентуални отрицателни последствия за околната среда и човешкото здраве поради потенциално опасните вещества, които обикновено са свързани с ЕЕО. В същото време Вашето съдействие за правилното изхвърляне на този продукт ще допринесе за ефективното използване на природните ресурси. За повече информация относно това къде можете да предадете за рециклиране на този продукт, моля свържете се с Вашите местни власти, с органа, отговорен за отпадъците, с одобрената система за ИУЕЕО или с Вашата местна служба за битови отпадъци, или посетете www.canon-europe.com/weee, или www.canon-europe.com/battery.

Doar pentru Uniunea Europeană și EEA (Norvegia, Islanda și Liechtenstein)



Aceste simboluri indică faptul că acest produs nu trebuie aruncat împreună cu deșeurile menajere, în conformitate cu Directiva DEEE (2012/19/UE), Directiva referitoare la baterii (2006/66/CE) și/sau legile dvs. naționale ce implementează aceste Directive. Dacă un simbol chimic este imprimat sub simbolul de mai sus, în conformitate cu Directiva referitoare la baterii, acest simbol indică prezența în baterie sau acumulator a unui metal greu (Hg = Mercur, Cd = Cadmiu, Pb = Plumb) într-o concentrație mai mare decât pragul admis specificat în Directiva referitoare la baterii. Acest produs trebuie înmănat punctului de colectare adecvat, ex: printr-un schimb autorizat unu la unu atunci când cumpărați un produs nou similar sau la un loc de colectare autorizat pentru reciclarea reziduurilor de echipament electric și electronic (EEE) și baterii și acumulatori. Administrarea neadecvată a acestui tip de deșeuri, ar putea avea un

impact asupra mediului și asupra sănătății umane datorită substanțelor cu potențial de risc care sunt în general asociate cu EEE. Cooperarea dvs. în direcția reciclării corecte a acestui produs va contribui la o utilizare eficientă a resurselor naturale. Pentru mai multe informații despre reciclarea acestui produs, vă rugăm să contactați biroul dvs. local, autoritățile responsabile cu deșeurile, schema aprobată sau serviciul dvs. responsabil cu deșeurile menajere sau vizitați-ne la www.canon-europe.com/weee, sau www.canon-europe.com/battery.

Samo za Europsku uniju i EEA (Norveška, Island i Lihtenštajn)



Oznaka pokazuje da se ovaj proizvod ne smije odlagati s komunalnim i ostalim vrstama otpada, u skladu s direktivom WEEE (2012/19/EC), Direktivom o baterijama (2006/66/EC) i Pravilnikom o gospodarenju otpadnim baterijama i akumulatorima te Pravilnikom o gospodarenju otpadnim električnim i elektroničkim uređajima i opremom. Ako je ispod prethodno prikazane oznake otisnut kemijski simbol, u skladu s Direktivom o baterijama, to znači da se u ovoj bateriji ili akumulatoru nalazi teški metal (Hg = živa, Cd = kadmij, Pb = olovo) i da je njegova koncentracija iznad razine propisane u Direktivi o baterijama. Ovaj bi proizvod trebalo predati ovlaštenom skupljaču EE otpada ili prodavatelju koji je dužan preuzeti otpadni proizvod po sistemu jedan za jedan, ukoliko isti odgovara vrsti te je obavljao primarne funkcije kao i isporučena EE oprema. Otpadne baterije i akumulatori predaju se ovlaštenom skupljaču otpadnih baterija ili akumulatora ili prodavatelju bez naknade i obveze kupnje za krajnjeg korisnika. Neodgovarajuće rukovanje ovom vrstom otpada može utjecati na okoliš i ljudsko zdravlje zbog potencijalno opasnih supstanci koje se najčešće nalaze na takvim mjestima. Vaša suradnja u pravilnom zbrinjavanju ovog proizvoda pridonijet će djelotvornom iskorištavanju prirodnih resursa. Dodatne informacije o recikliranju ovog proizvoda zatražite od svog lokalnog gradskog ureda, službe za zbrinjavanje otpada, odobrenog programa ili komunalne službe za uklanjanje otpada ili pak na stranicama www.canon-europe.com/weee ili www.canon-europe.com/battery.

Korisnici u Srbiji



Ovaj simbol označava da ovaj proizvod ne sme da se odlaže sa ostalim kućnim otpadom, u skladu sa WEEE Direktivom (2012/19/EU), Direktivom o baterijama (2006/66/EC) i nacionalnim zakonima. Ukoliko je ispod gore navedenog simbola odštampan hemijski simbol, u skladu sa Direktivom o baterijama, ovaj simbol označava da su u ovoj bateriji ili akumulatoru prisutni teški metali (Hg – živa, Cd – kadmijum, Pb - olovo) u koncentracijama koje premašuju prihvatljivi prag naveden u Direktivi o baterijama. Ovaj proizvod treba predati određenom centru za prikupljanje, npr. po principu „jedan-za-jedan“ kada kupujete sličan novi proizvod, ili ovlašćenom centru za prikupljanje za reciklažu istrošene električne i elektronske opreme (EEE), baterija i akumulatora. Nepravilno rukovanje ovom vrstom otpada može imati negativne posledice po životnu sredinu i ljudsko zdravlje usled potencijalno opasnih materijala koji se uglavnom vezuju za EEE. Vaša saradnja na ispravnom odlaganju ovog proizvoda će doprineti efikasnom korišćenju prirodnih resursa. Više informacija o tome kako možete da reciklirate ovaj proizvod potražite od lokalnih gradskih

vlasti, komunalne službe, odobrenog plana reciklaže ili servisa za odlaganje kućnog otpada, ili posetite stranicu www.canon-europe.com/weee, ili www.canon-europe.com/battery.

Handling Precautions

- **When Repairing, Lending, or Disposing of the Printer**
- **Legal Restrictions on Scanning/Copying**
- **Ink Tips**

When Repairing, Lending, or Disposing of the Printer

If you have entered personal data, passwords and/or other security settings on the printer, such information may be stored in the printer.

When sending the printer for repair, lending or transferring the printer to another person, or disposing of the printer, please be sure to follow the steps below in order to delete such information and prevent third parties from accessing it.



- Select  (**Setup**) on the HOME screen and select **Printer settings > Reset settings > Reset all > Yes**.

Legal Restrictions on Scanning/Copying

Scanning, printing, copying, or modifying copies of the following may be punishable under law.

This list is non-exhaustive. When in doubt, check with a local legal representative.

- Paper money
- Money orders
- Certificates of deposit
- Postage stamps (canceled or uncanceled)
- Identification badges or insignia
- Selective service or draft papers
- Checks or drafts issued by governmental agencies
- Motor vehicle licenses and certificates of title
- Traveler's checks
- Food stamps
- Passports
- Immigration papers
- Internal revenue stamps (canceled or uncanceled)
- Bonds or other certificates of indebtedness
- Stock certificates
- Copyrighted works or works of art, without the owner's consent

Ink Tips

How is ink used for various purposes other than printing?

Ink may be used for purposes other than printing.

During initial setup, some of the ink from the bundled ink bottles is used to fill the print head's nozzles to ensure the printer is print-ready.

Therefore, the page yield of the initial bundled set of ink bottles is lower than that of the subsequent sets of bottles.

To keep printer's performance, Canon printer performs cleaning automatically according to its condition. When the printer performs cleaning, a small amount of ink is consumed. In this case, all colors of ink may be consumed.

[Cleaning function]

The cleaning function helps the printer to suck air bubbles or ink itself from the nozzle and thus prevents print quality degradation or nozzle clogging.

▶▶▶ Important

- The used ink is ejected into the maintenance cartridge. When the maintenance cartridge becomes full, replacement is necessary. If the displayed message indicates that the maintenance cartridge is nearly full, promptly obtain a new one.

➔ [Replacing the Maintenance Cartridge](#)

Does black-and-white printing use color ink?

Black-and-white printing may use ink other than black ink depending on the type of printing paper or the settings of the printer driver. So, color ink is consumed even when printing in black-and-white.

Similarly, color inks are also consumed along with black ink during print head cleaning when Black is specified for cleaning.

Online Manual

This manual has been confirmed to be displayed on the following web browsers (latest version).

- Windows device
Microsoft Edge and Google Chrome
- macOS / iOS / iPadOS device
Safari
- Android device
Google Chrome

* Set your browser to allow cookies and enable JavaScript.

The illustrations in this manual are based on the TC-20M printer. The illustrations may differ from the model you are using.

Screenshots in This Manual

For Windows:

The screenshots used in this manual are taken with Windows 10.

For macOS:

The screenshots used in this manual are taken with macOS Catalina 10.15.