



# LCD Monitor Quick Start Guide

DesignVue Designer Monitor | PD Series



DN: PD05UA-EQ-V1

© 2022 BenQ Corporation. All rights reserved. Rights of modification reserved.

## 1 Check mounting environment

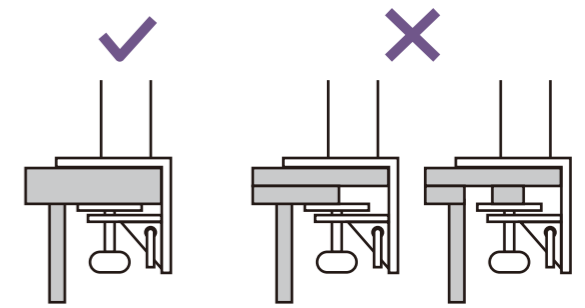
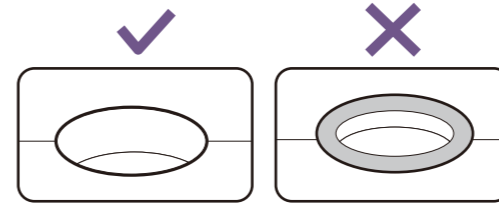

## 2 Check desk thickness

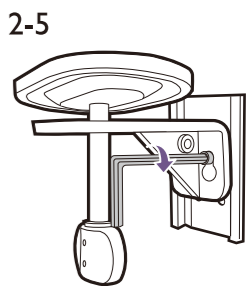
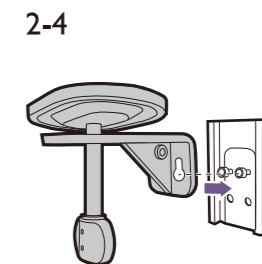
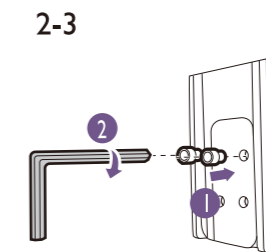
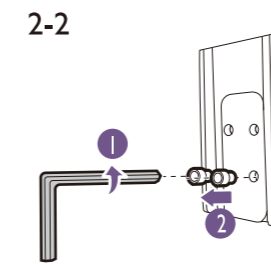
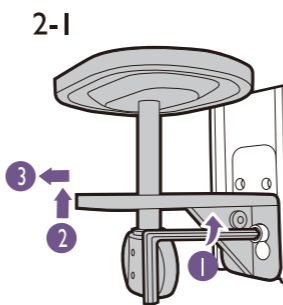
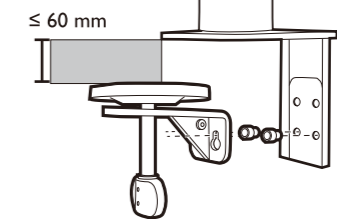
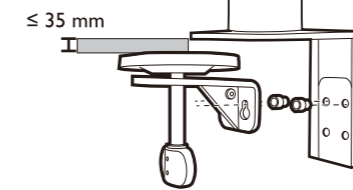

## 3 Stand installation

### A Clamp mounting

3A-1

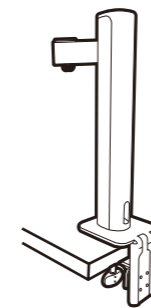

3A-2

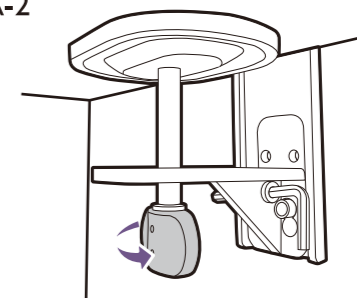

### B Grommet mounting

3B-1

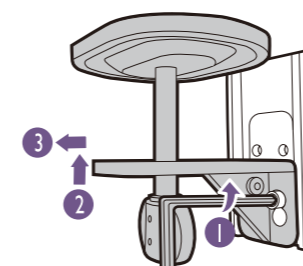

3B-2

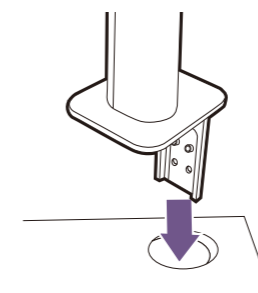

3B-3

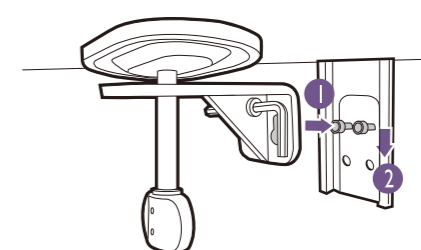

3B-4

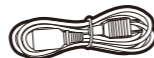
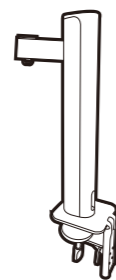
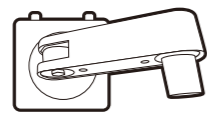
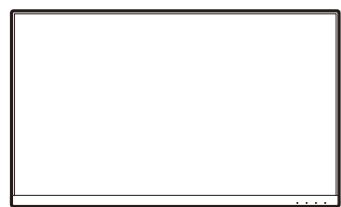
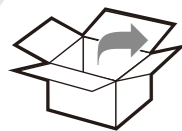
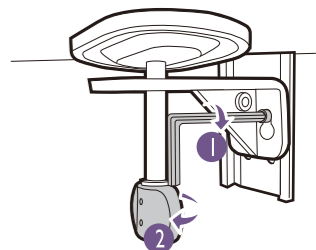

Hotkey Puck G2



HDMI



DP

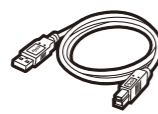

USB



USB-C™



Quick Start Guide



Regulatory Statements



Safety Instructions

The terms HDMI, HDMI High-Definition Multimedia Interface, HDMI Trade Dress and the HDMI Logos are trademarks or registered trademarks of HDMI Licensing Administrator, Inc.

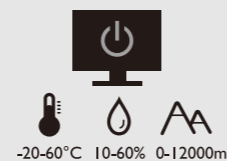
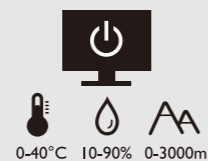

High-Definition Multimedia Interface

(For models with HDMI inputs)



P/N: 4J.XXXXX.XXX

## 4 Mounting the monitor head

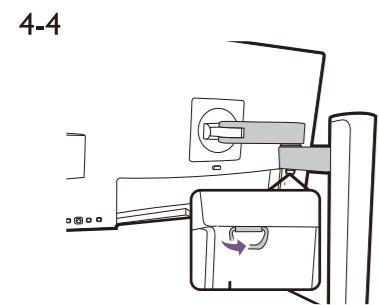
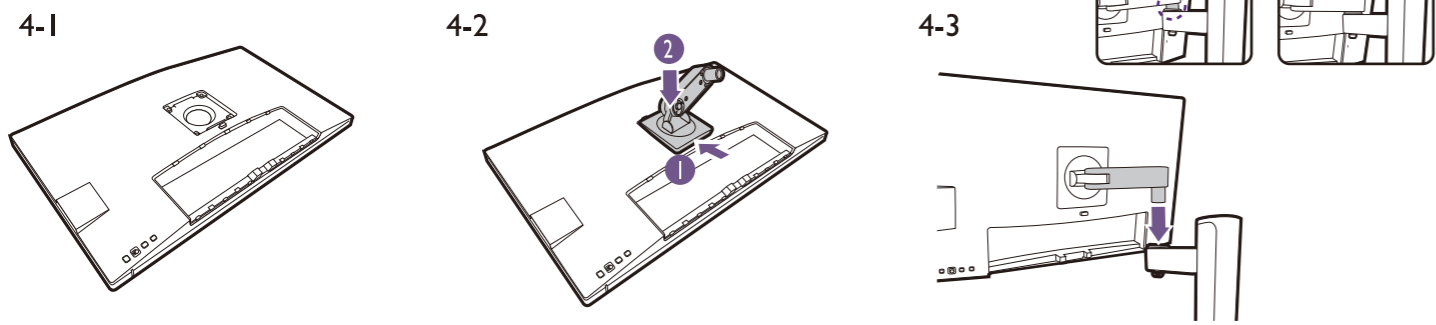

## 5 Connect and organize cables

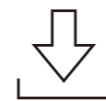
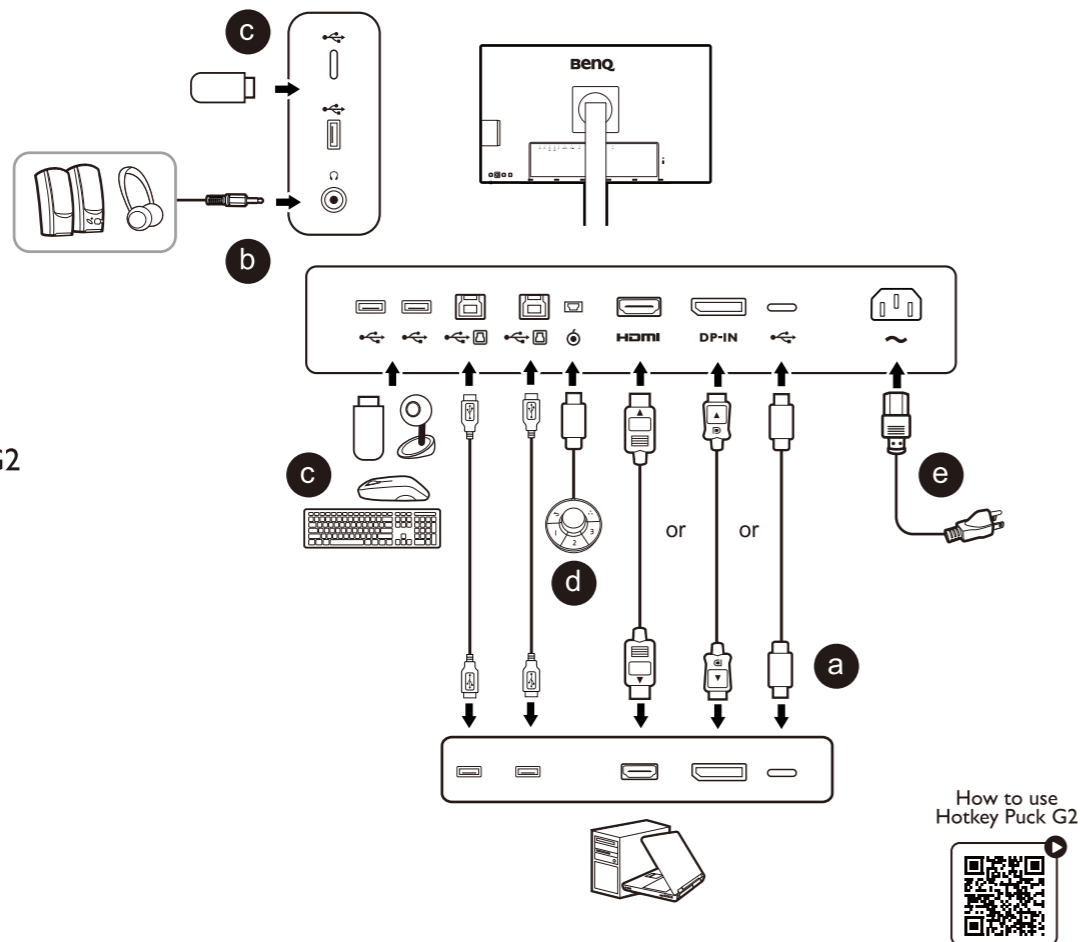
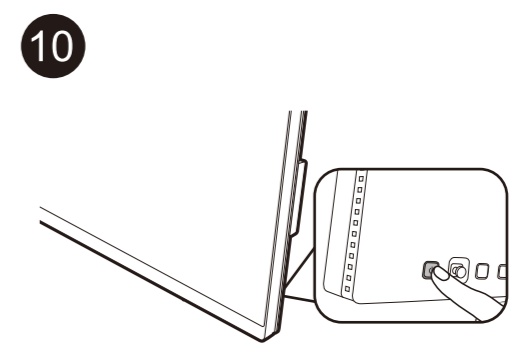
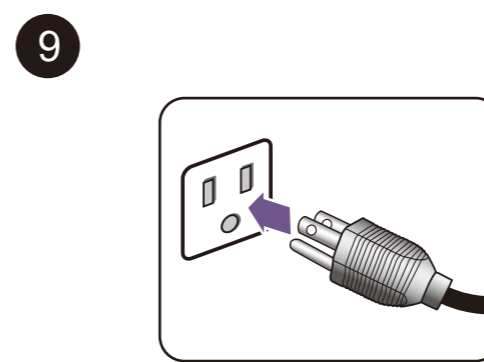
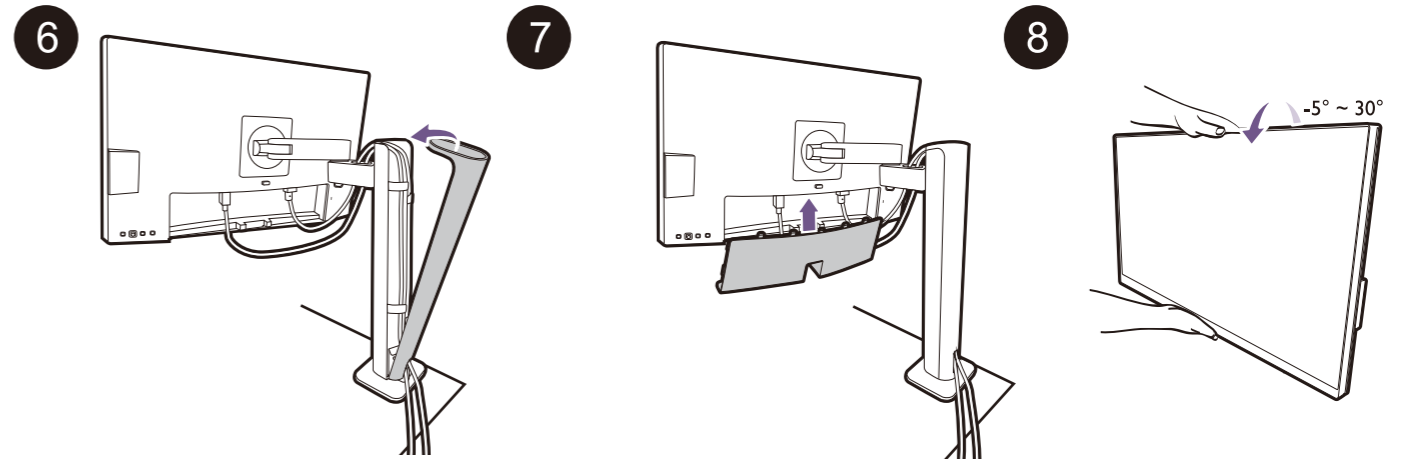
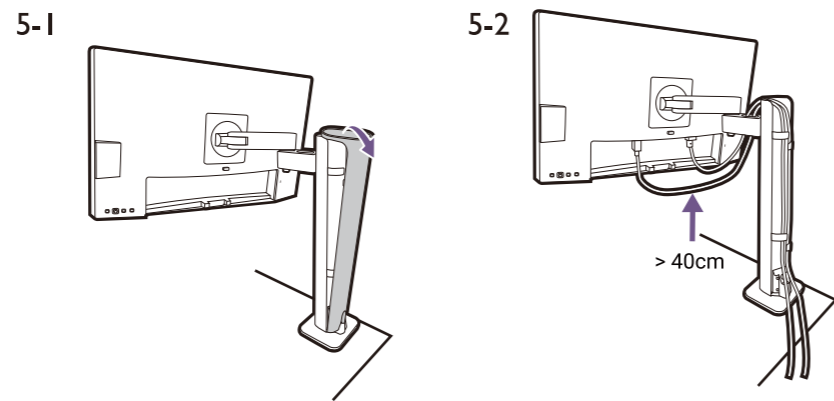

## Software installation

Display Pilot: for display arrangement & color matching (ICCsyntax)

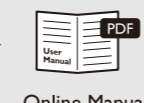
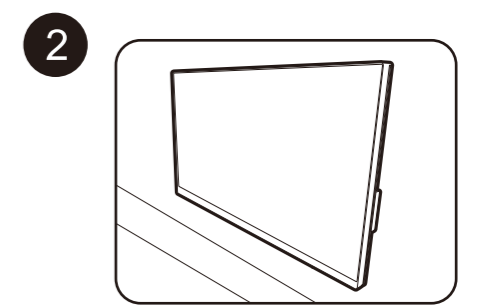
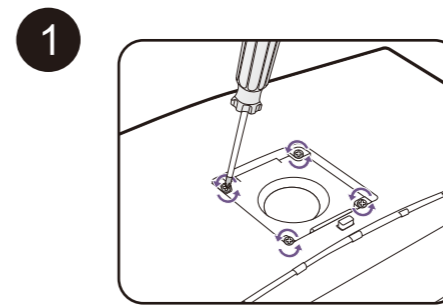
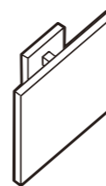
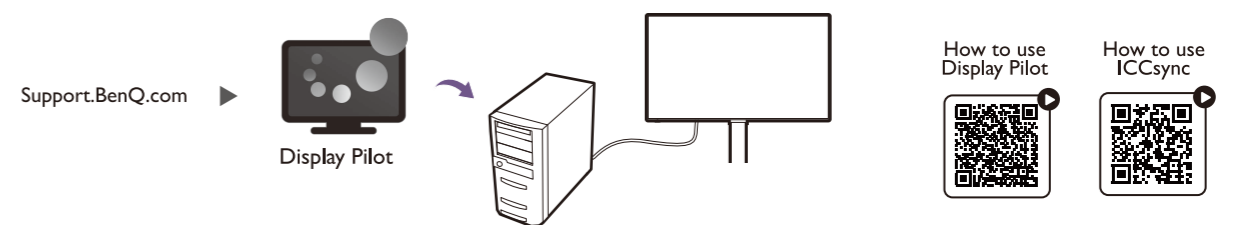

Online Manual



Product Support



Software Download

For professional color display



CAD / CAM Mode



Animation Mode

For work efficiency



KVM Switch