

CDE30

Commercial Display User Guide

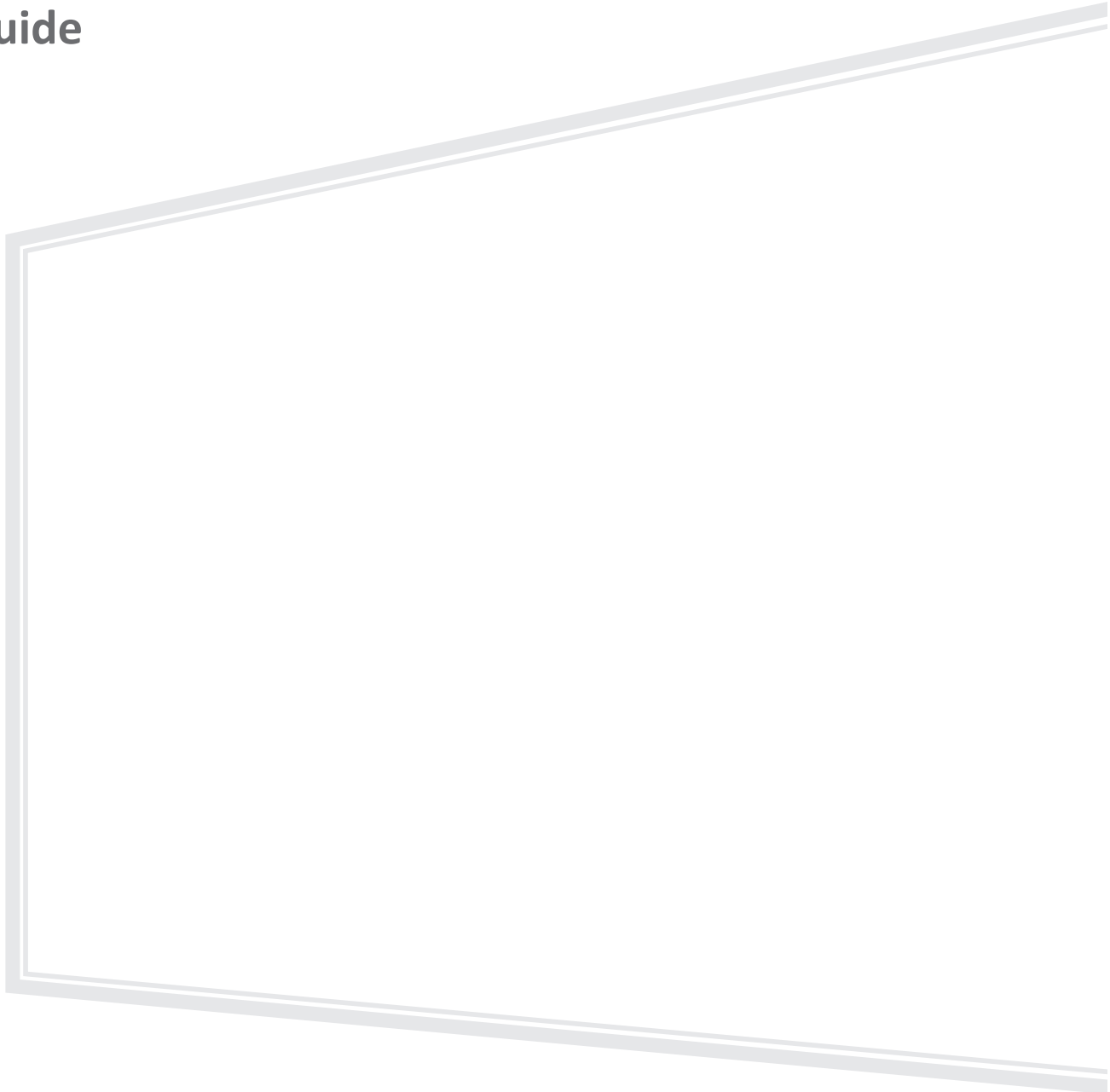

IMPORTANT: Please read this User Guide to obtain important information on installing and using your product in a safe manner, as well as registering your product for future service. Warranty information contained in this User Guide will describe your limited coverage from ViewSonic® Corporation, which is also found on our web site at <http://www.viewsonic.com> in English, or in specific languages using the Regional selection box of our website.

Model No. VS19112 | VS19113 | VS19114 | VS19115 | VS19116 | VS19117
P/N: CDE4330 | CDE5530 | CDE6530 | CDE7530 | CDE8630 | CDE9830

Thank you for choosing ViewSonic®

As a world-leading provider of visual solutions, ViewSonic® is dedicated to exceeding the world's expectations for technological evolution, innovation, and simplicity. At ViewSonic®, we believe that our products have the potential to make a positive impact in the world, and we are confident that the ViewSonic® product you have chosen will serve you well.

Once again, thank you for choosing ViewSonic®!

Safety Precautions

Please read the following **Safety Precautions** before you start using the device.

- Keep this user guide in a safe place for later reference.
- Read all warnings and follow all instructions.
- Do not use the device near water. To reduce the risk of fire or electric shock, do not expose the device to moisture.
- Never remove the rear cover. This display contains high-voltage parts. You may be seriously injured if you touch them.
- Avoid exposing the device to direct sunlight or other sources of sustained heat.
- Do not install near any heat sources such as radiators, heat registers, stoves, or other devices (including amplifiers) that may increase the temperature of the device to dangerous levels.
- Use a soft, dry cloth to clean the external housing. For more information, refer to the "Maintenance" section.
- When moving the device, be careful not to drop or bump the device on anything.
- Do not place the device on an uneven or unstable surface. The device may fall over resulting in an injury or a malfunction.
- Do not place any heavy objects on the device or connection cables.
- If smoke, an abnormal noise, or a strange odor is present, immediately turn the device off and call your dealer or ViewSonic®. It is dangerous to continue using the device.
- The device is a monitor with an LED backlight intended for general office use.
- Do not attempt to circumvent the safety provisions of the polarized or grounding-type plug. A polarized plug has two blades with one wider than the other. A grounding-type plug has two blades and a third grounding prong. The wide blade and the third prong are provided for your safety. If the plug does not fit into your outlet, obtain an adapter and do not attempt to force the plug into the outlet.
- When connecting to a power outlet, DO NOT remove the grounding prong. Please ensure grounding prongs are NEVER REMOVED.
- Protect the power cord from being treaded upon or pinched, particularly at the plug, and at the point where it emerges from the equipment. Ensure that the power outlet is located near the equipment so that it is easily accessible.
- Only use attachments/accessories specified by the manufacturer.

- When a cart is used, use with caution when moving the cart/equipment combination to avoid injury from tipping over.
- Disconnect the power plug from the AC outlet if the device is not being used for a long period of time.
- Place the device in a well-ventilated area. Do not place anything on the device that prevents heat dissipation. Also, avoid any direct lighting.

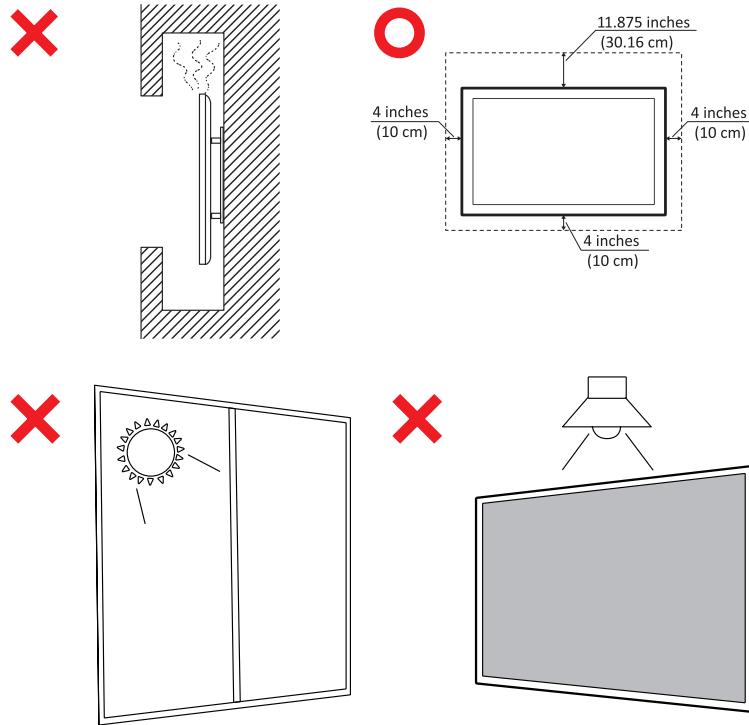

CAUTION:

Immediately unplug your device from the wall outlet and refer servicing to a qualified service personnel under the following conditions:

- When the power supply cord or plug is damaged.
- If liquid has been spilled onto or objects have fallen into the unit.
- If the unit has been exposed to moisture.
- If the unit does not operate normally or has been dropped.

Never place the device in an unstable location. The device may fall, causing serious personal injury or death. Many injuries, particularly to children, can be avoided by taking simple precautions such as:

- Using cabinets or stands recommended by the manufacturer of the device.
- Only using furniture that can safely support the device.
- Ensuring the device is not overhanging the edge of the supporting furniture.
- Not placing the device on tall furniture (e.g., cupboards or bookcases) without anchoring both the furniture and the device to a suitable support.
- Not placing the device on cloth or other materials that may be located between the device and supporting furniture.
- Educating children about the dangers of climbing on furniture to reach the device or its controls.

If the existing device is going to be retained and relocated, the same considerations as above should be applied.

Contents

Safety Precautions.....	3
Contents.....	6
Introduction	9
Package Contents	9
Wall Mounting Specifications (VESA)	10
CDE4330	10
CDE5530	11
CDE6530	11
CDE7530	12
CDE8630	12
CDE9830	13
Product Overview	14
CDE4330	14
CDE5530	15
CDE6530	16
CDE7530	17
CDE8630	18
CDE9830	19
Control Panel	20
I/O Panels - CDE4330 CDE5530.....	21
I/O Panels - CDE6530 CDE7530 CDE8630 CDE9830	22
Remote Control	23
Inserting Remote Control Batteries	24
Remote Control Receiver Range	25
Making Connections	26
Connecting External Devices	26
USB Type-C Connection.....	26
HDMI Connection	26
RS-232 Connection	27
USB and Network Connections	28
Media Player Connection	29

Using Your Display.....	32
Powering On/Off Your Display.....	32
Initial Launch Setup	33
Home Screen	36
General Settings	37
Network.....	38
Device.....	41
System.....	48
General Settings Menu Tree	50
On-Screen Display (OSD) Menu	52
Navigating the OSD Menu using the Remote Control.....	52
On-Screen Display (OSD) Menu Tree	53
Picture	55
Low Blue Light Filter and Eye Health.....	56
Screen.....	58
Audio	60
Time.....	61
Advanced.....	62
About.....	64
Embedded Applications and Settings.....	65
vCastReceiver & vCastSender	65
Cast Sender from Windows-based, Macbook, and Chrome devices.....	66
Cast Sender from Mobile Devices: iOS-based (iPhone, iPad) and Android OS based phone/tablet.	67
Other Default Applications	68
vSweeper.....	68
Folders.....	69
RS-232 Protocol.....	71
Description	71
RS-232 Hardware Specification	71
LAN Hardware Specification.....	72
RS-232 Communication Setting.....	72
LAN Communication Setting	72
Command Message Reference.....	72
Protocol	73
Set-Function Listing.....	73

Appendix.....	78
Specifications.....	78
USB Media Support Format.....	80
Photo.....	80
Video.....	80
Audio.....	84
Subtitle.....	90
Timing Table.....	91
HDMI PC.....	91
HDMI.....	91
Type-C.....	92
Troubleshooting.....	94
Maintenance.....	96
General Precautions.....	96
Cleaning the Screen.....	96
Cleaning the Case.....	96
Regulatory and Service Information	97
Compliance Information.....	97
FCC Compliance Statement.....	97
Industry Canada Statement.....	97
CE Conformity for European Countries.....	98
Declaration of RoHS2 Compliance.....	99
ENERGY STAR Statement.....	100
Indian Restriction of Hazardous Substances.....	101
Product Disposal at End of Product Life.....	101
Copyright Information.....	102
Customer Service.....	103
Limited Warranty.....	104
Mexico Limited Warranty.....	107

Introduction

Package Contents

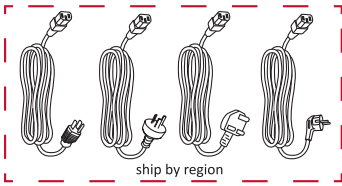

Power Cable (3 m/ 9.84 ft)



HDMI Cable (3 m/9.84 ft)



Remote Control



AAA Battery x 2



RS-232 Adapter



Wall Mount Screw x 4



Compliance Statement

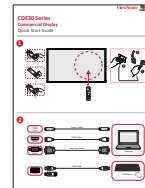

Quick Start Guide

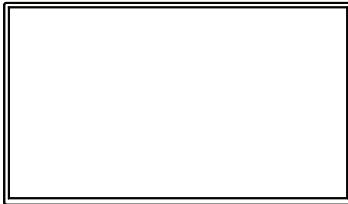

LCD Display

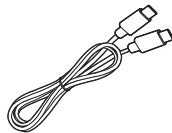

USB-C Cable (1.8 m/ 5.9 ft)

NOTE: The power cord and video cables included in your package may vary depending on your country. Please contact your local reseller for more information.

Wall Mounting Specifications (VESA)

NOTE: Please follow the instructions in the wall mount installation guide to install your wall mount or mobile mount bracket. If attaching to other building materials, please contact your nearest dealer.

CDE4330

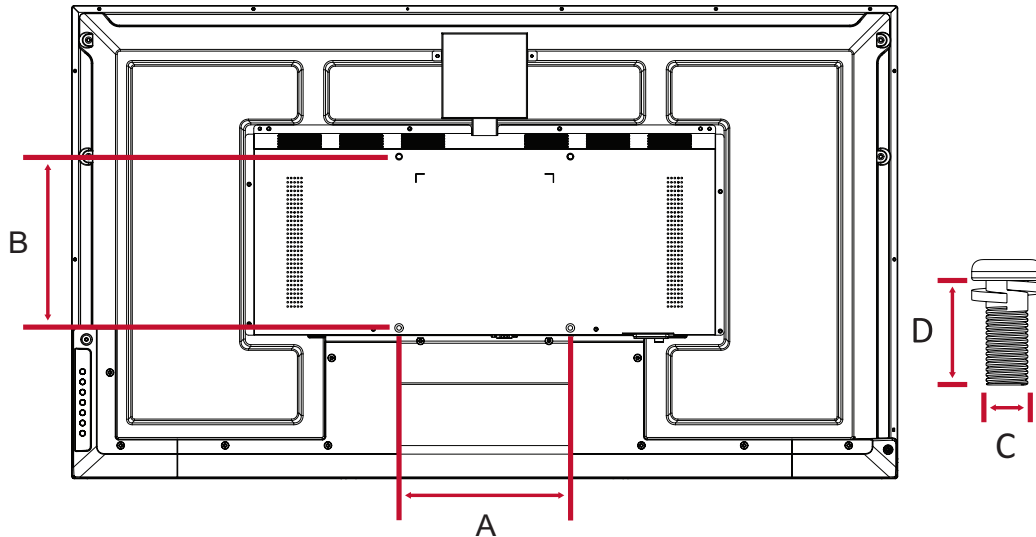

Model	VESA Spec. (A x B)	Standard Screw (C x D)	Quantity
CDE4330	200 x 200 mm	M6 x 12 mm	4

NOTE: Do not use screws that are longer than the standard dimension, as they may cause damage to the inside of the display.

CDE5530

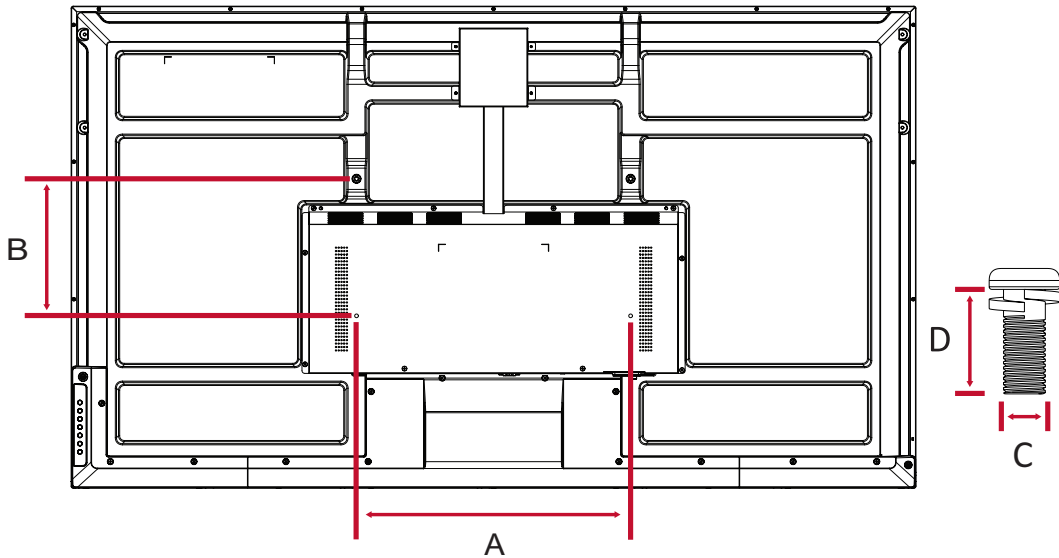

Model	VESA Spec. (A x B)	Standard Screw (C x D)	Quantity
CDE5530	400 x 200 mm	M6 x 12 mm	4

NOTE: Do not use screws that are longer than the standard dimension, as they may cause damage to the inside of the display.

CDE6530

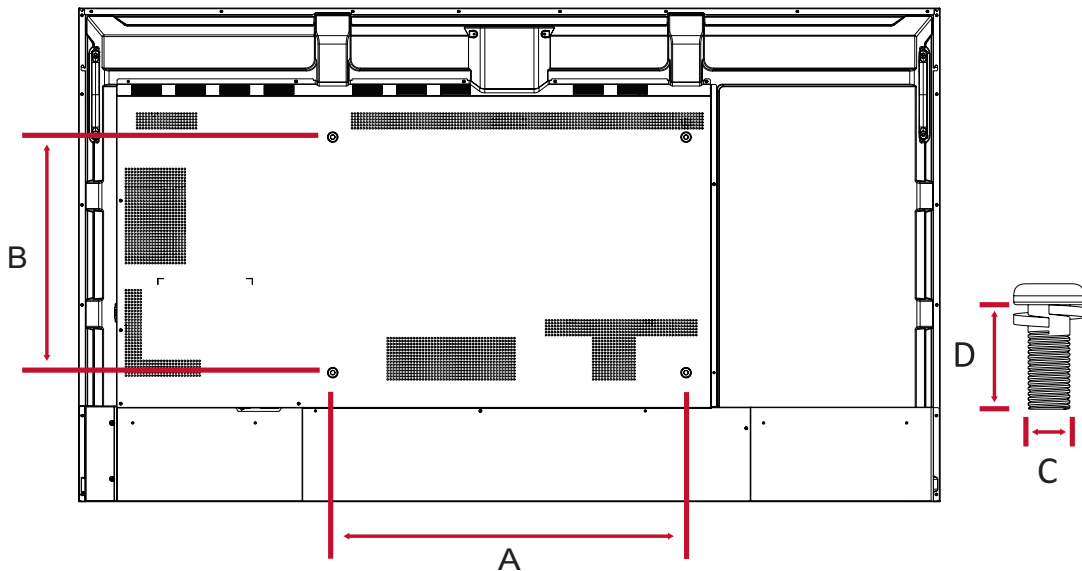

Model	VESA Spec. (A x B)	Standard Screw (C x D)	Quantity
CDE6530	600 x 400 mm	M8 x 25 mm	4

NOTE: Do not use screws that are longer than the standard dimension, as they may cause damage to the inside of the display.

CDE7530

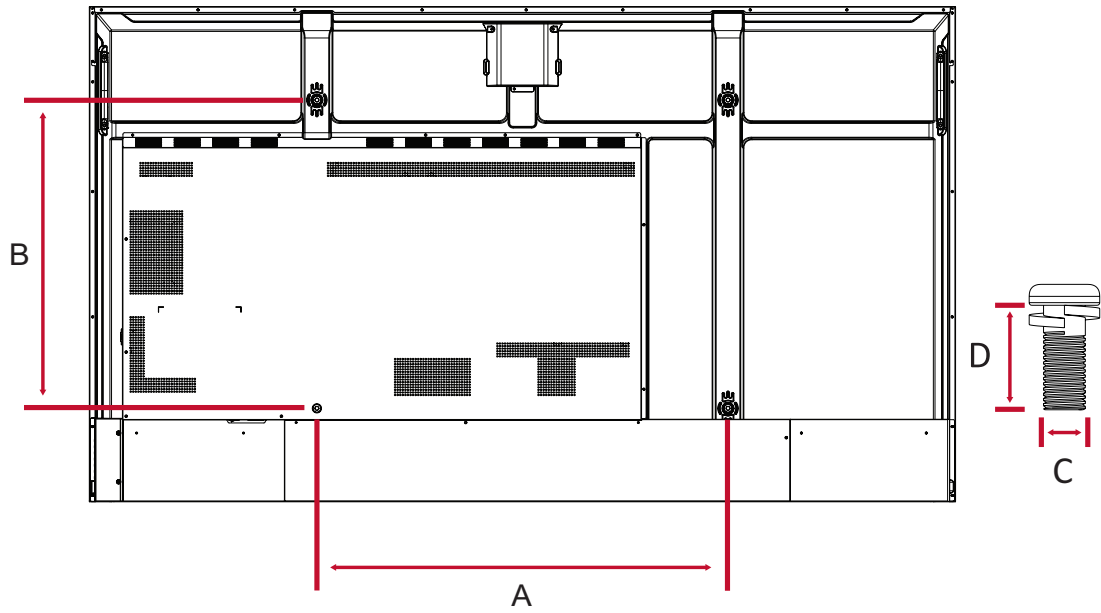

Model	VESA Spec. (A x B)	Standard Screw (C x D)	Quantity
CDE7530	800 x 600 mm	M8 x 25 mm	4

NOTE: Do not use screws that are longer than the standard dimension, as they may cause damage to the inside of the display.

CDE8630

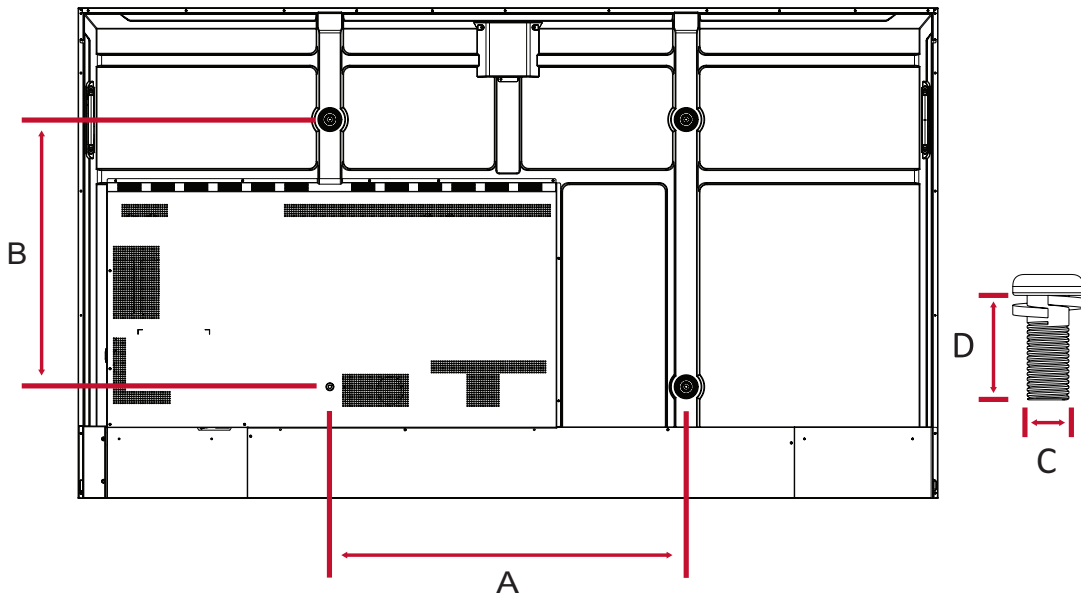

Model	VESA Spec. (A x B)	Standard Screw (C x D)	Quantity
CDE8630	800 x 600 mm	M8 x 25 mm	4

NOTE: Do not use screws that are longer than the standard dimension, as they may cause damage to the inside of the display.

CDE9830

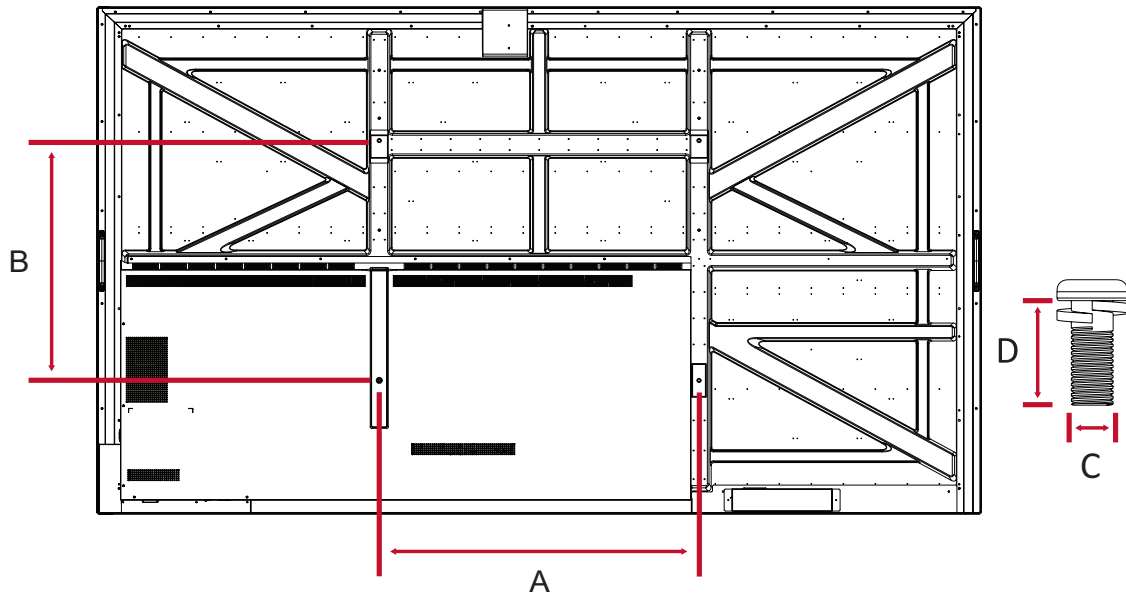

Model	VESA Spec. (A x B)	Standard Screw (C x D)	Quantity
CDE9830	800 x 600 mm	M8 x 25 mm	4

NOTE: Do not use screws that are longer than the standard dimension, as they may cause damage to the inside of the display.

Product Overview

CDE4330

Front Panel

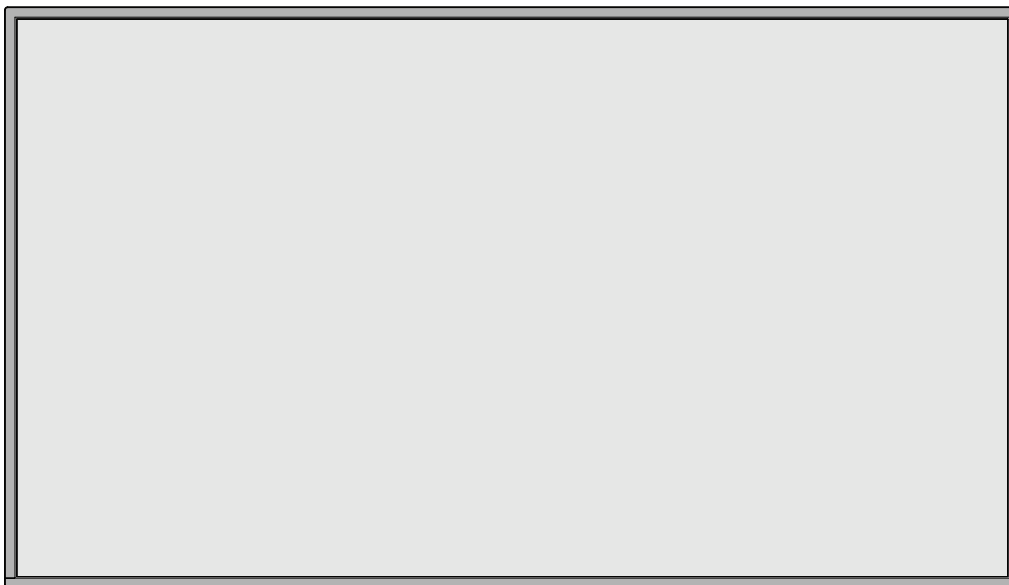

Rear Panel

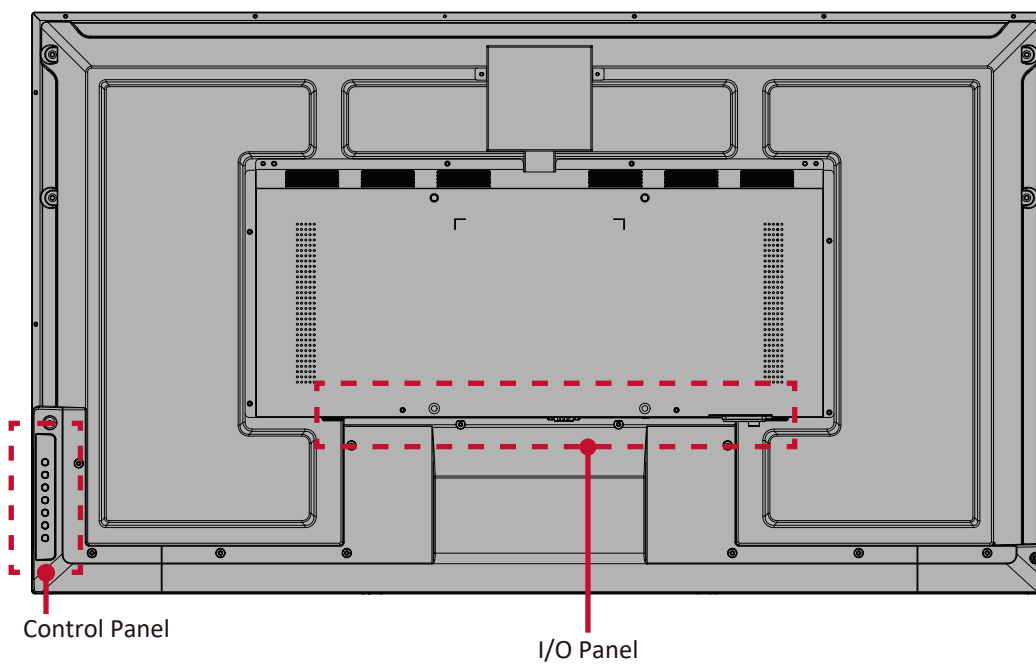

CDE5530

Front Panel



Rear Panel

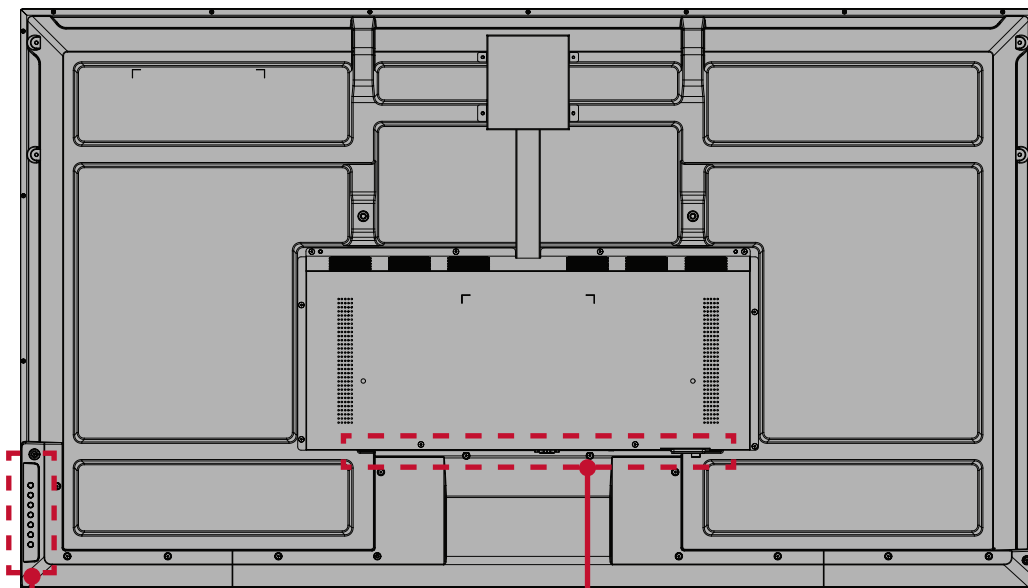

Control Panel

I/O Panel

CDE6530

Front Panel

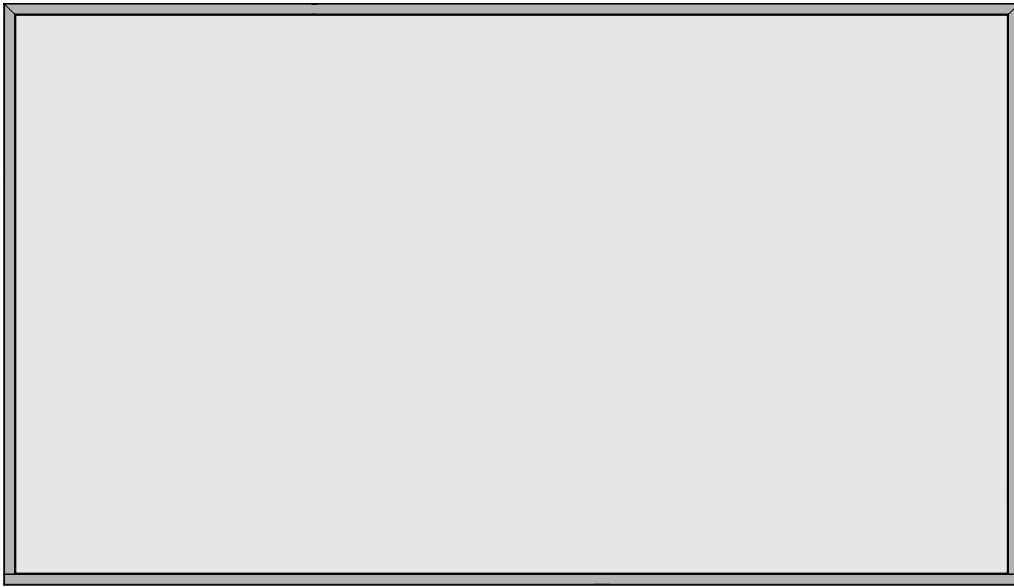

Rear Panel

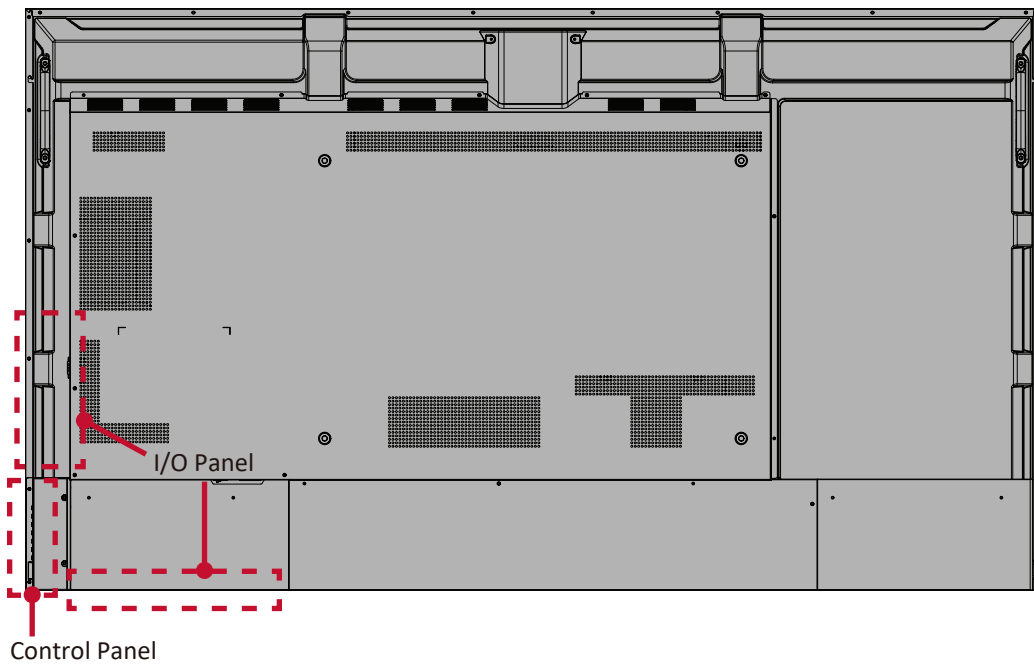

CDE7530

Front Panel



Rear Panel

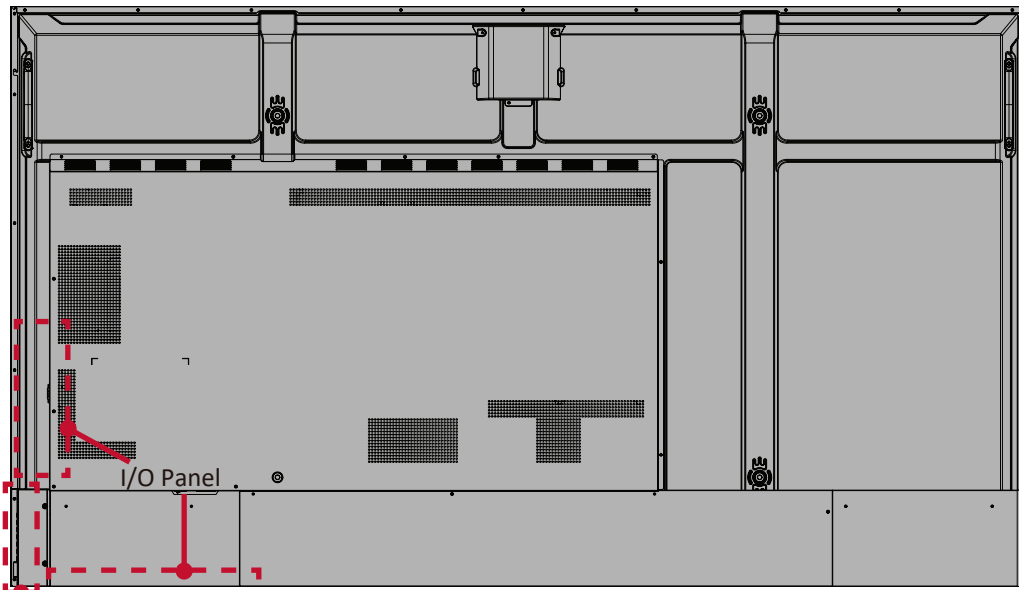

Control Panel

CDE8630

Front Panel



Rear Panel

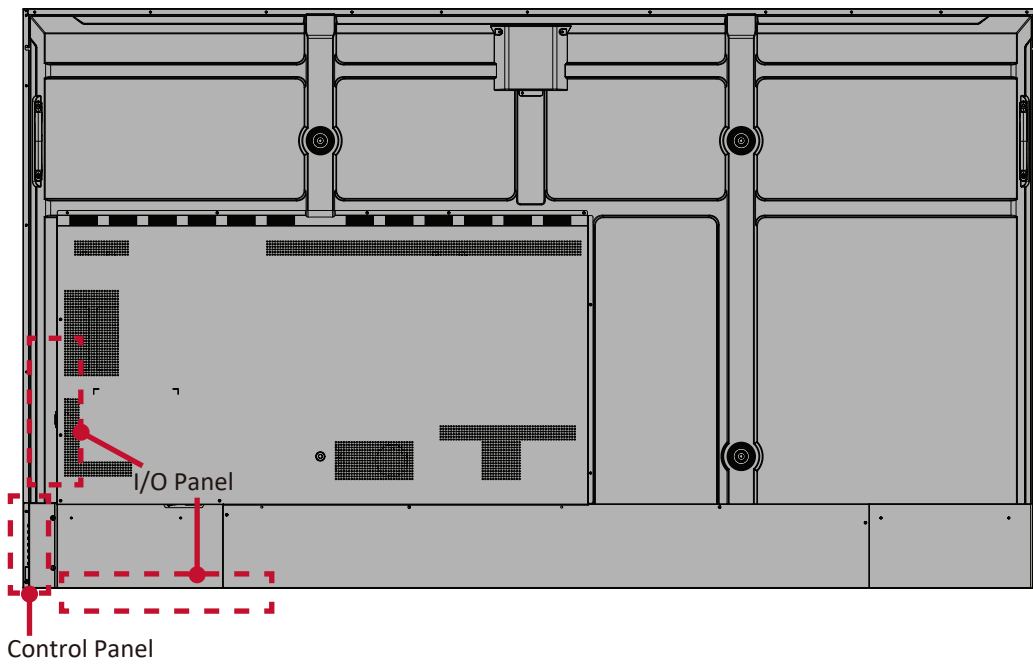

CDE9830

Front Panel



Rear Panel

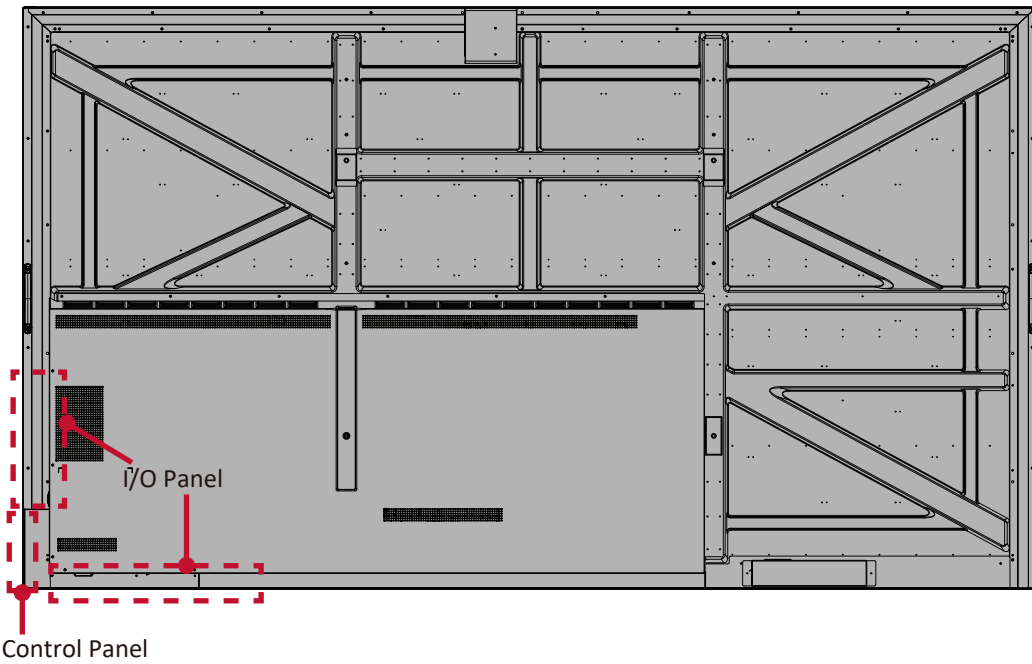

Control Panel

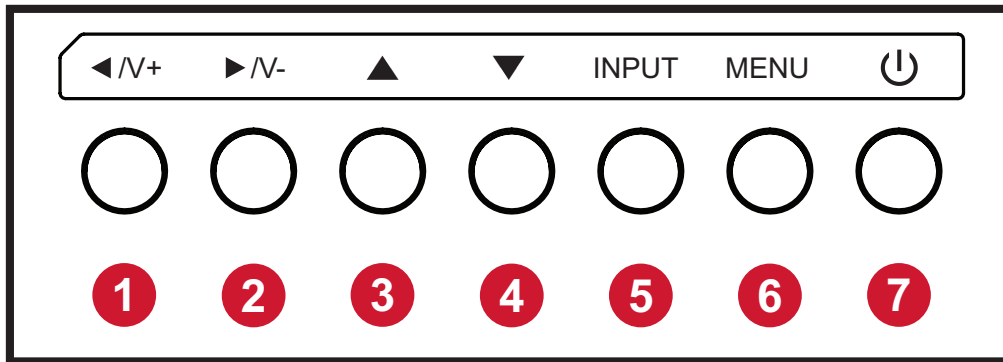

Number	Button	Description
1	Left / Volume Increase	<ul style="list-style-type: none"> • Increase the volume level. • In the OSD Menu, press to adjust the value of the selected item.
2	Right / Volume Decrease	<ul style="list-style-type: none"> • Decrease the volume level. • In the OSD Menu, press to adjust the value of the selected item.
3	Up	<ul style="list-style-type: none"> • In the OSD Menu, press to select an item.
4	Down	<ul style="list-style-type: none"> • In the OSD Menu, press to select an item.
5	Input	<ul style="list-style-type: none"> • Press the INPUT key to enter the input source menu, and press the Arrow keys to select the signal source. • Confirm an operation under the MENU key operations.
6	Menu	<ul style="list-style-type: none"> • Press the MENU key to enter the main menu. • Confirm the operation in the input source menu.
7	Power	<ul style="list-style-type: none"> • Press to turn on/off the display.

I/O Panels - CDE4330 | CDE5530

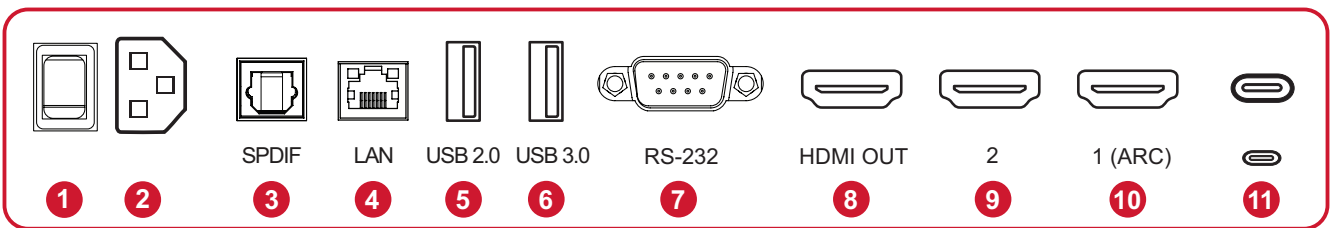
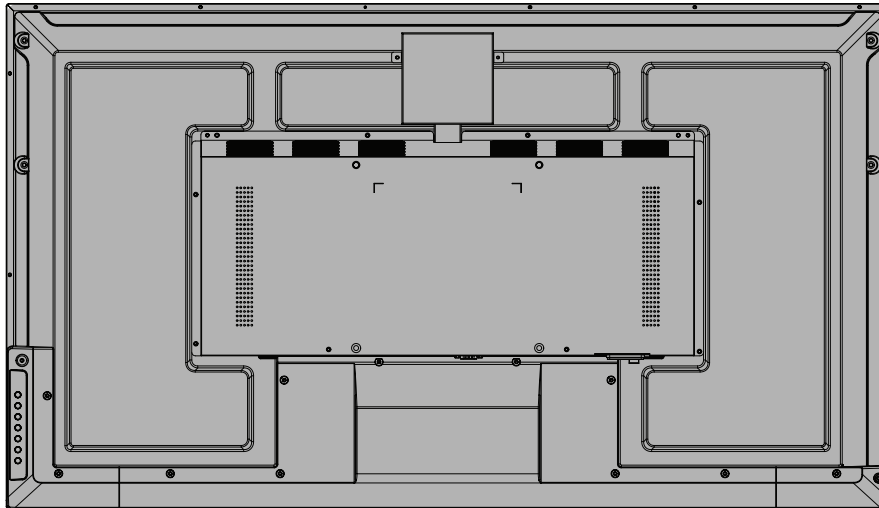

Number	Port	Description
1	Power Switch	Turn the device ON/OFF.
2	AC IN	AC power input.
3	SPDIF	Multichannel sound via optical signals.
4	LAN	Standard RJ45 (10M/100M/1G) Internet connection interface.
5	USB 2.0	Connect USB devices such as hard disks, keyboard, mouse, etc. (Output rating: 5Vdc/500mA)
6	USB 3.0	Connect USB devices such as hard disks, keyboard, mouse, etc. (Output rating: 5Vdc/900mA)
7	RS-232	Serial interface; used for mutual transfer of data between devices.
8	HDMI OUT	Extend content out to another display device.
9	HDMI 2	High definition input; connect to a PC with HDMI output, set-top box, or other video device.
10	HDMI 1 (ARC)	High definition input; connect to a PC with HDMI output, set-top box, or other video device.
11	USB Type C	USB Type C input; connect to a PC with USB Type C output. (Output rating: 20Vdc/3.25A).

I/O Panels - CDE6530 | CDE7530 | CDE8630 | CDE9830

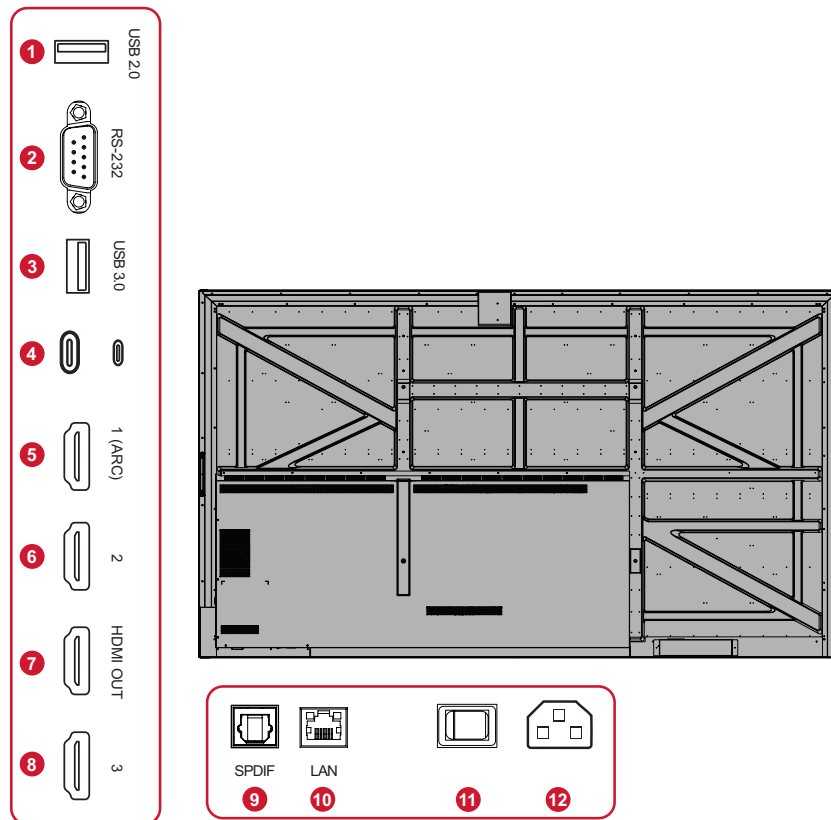

Number	Port	Description
1	USB 2.0	Connect USB devices such as hard disks, keyboard, mouse, etc. (Output rating: 5Vdc/500mA)
2	RS-232	Serial interface; used for mutual transfer of data between devices.
3	USB 3.0	Connect USB devices such as hard disks, keyboard, mouse, etc. (Output rating: 5Vdc/900mA)
4	USB Type C	USB Type C input; connect to a PC with USB Type C output. (Output rating: 20Vdc/3.25A).
5	HDMI 1 (ARC)	High definition input; connect to a PC with HDMI output, set-top box, or other video device.
6	HDMI 2	High definition input; connect to a PC with HDMI output, set-top box, or other video device.
7	HDMI OUT	Extend content out to another display device.
8	HDMI 3	High definition input; connect to a PC with HDMI output, set-top box, or other video device.
9	SPDIF	Multichannel sound via optical signals.
10	LAN	Standard RJ45 (10M/100M/1G) Internet connection interface.
11	Power Switch	Turn the device ON/OFF.
12	AC IN	AC power input.

Remote Control

Number	Description
1	Power on/off
2	Screen capture
3	Back to the Launcher screen
4	Back/Return to the previous page
5	Increase/Decrease the Volume
6	Number Keypad
7	Information
8	Input source selection
9	Media control buttons: <ul style="list-style-type: none"> • Red: Play/Pause • Green: Stop • Yellow: Forwards • Blue: Backwards
10	Settings menu
11	Up/Down/Right/Left/OK
12	Freeze screen
13	Mute/Unmute
14	Increase/Decrease Brightness
15	Blank Screen
16	Adjust Aspect Ratio

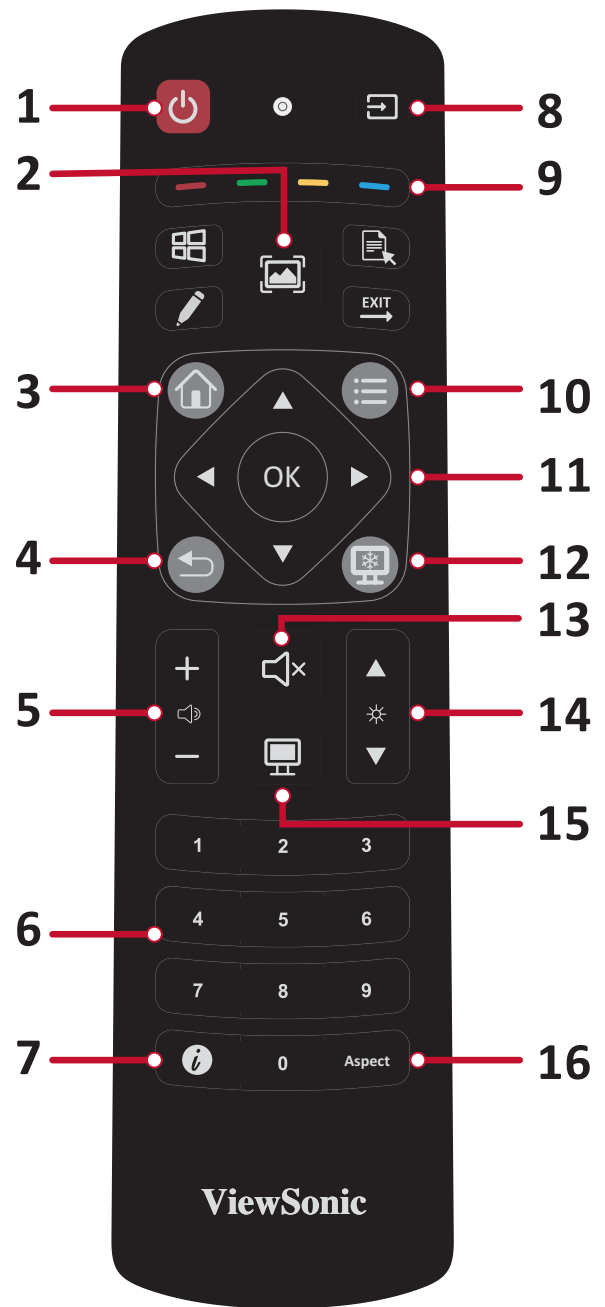

Inserting Remote Control Batteries

To insert batteries into the remote control:

1. Remove the cover on the rear of the remote control.
2. Insert two “AAA” batteries, ensuring the “+” symbol on the battery matches the “+” on the battery post.
3. Replace the cover by aligning it with the slot on the remote control and snapping the latch shut.

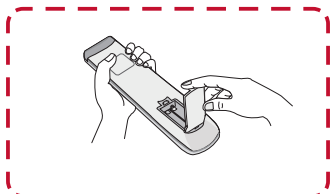

(1)

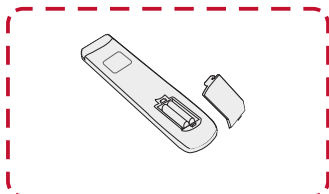

(2)

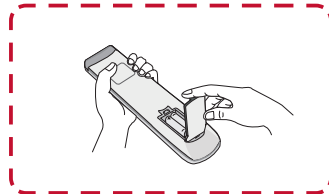

(3)

WARNING: There is a risk of explosion if batteries are replaced with the incorrect type.

NOTE:

- It is recommended that you do not mix battery types.
- Always dispose of old batteries in an environmentally friendly way. Contact your local government for more information on how to dispose of batteries safely.

Remote Control Receiver Range

The working range of the remote control is shown here. It has an effective range of 6 meters, 30° degrees left and right. Ensure there is nothing obstructing the remote control's signal to the receiver.

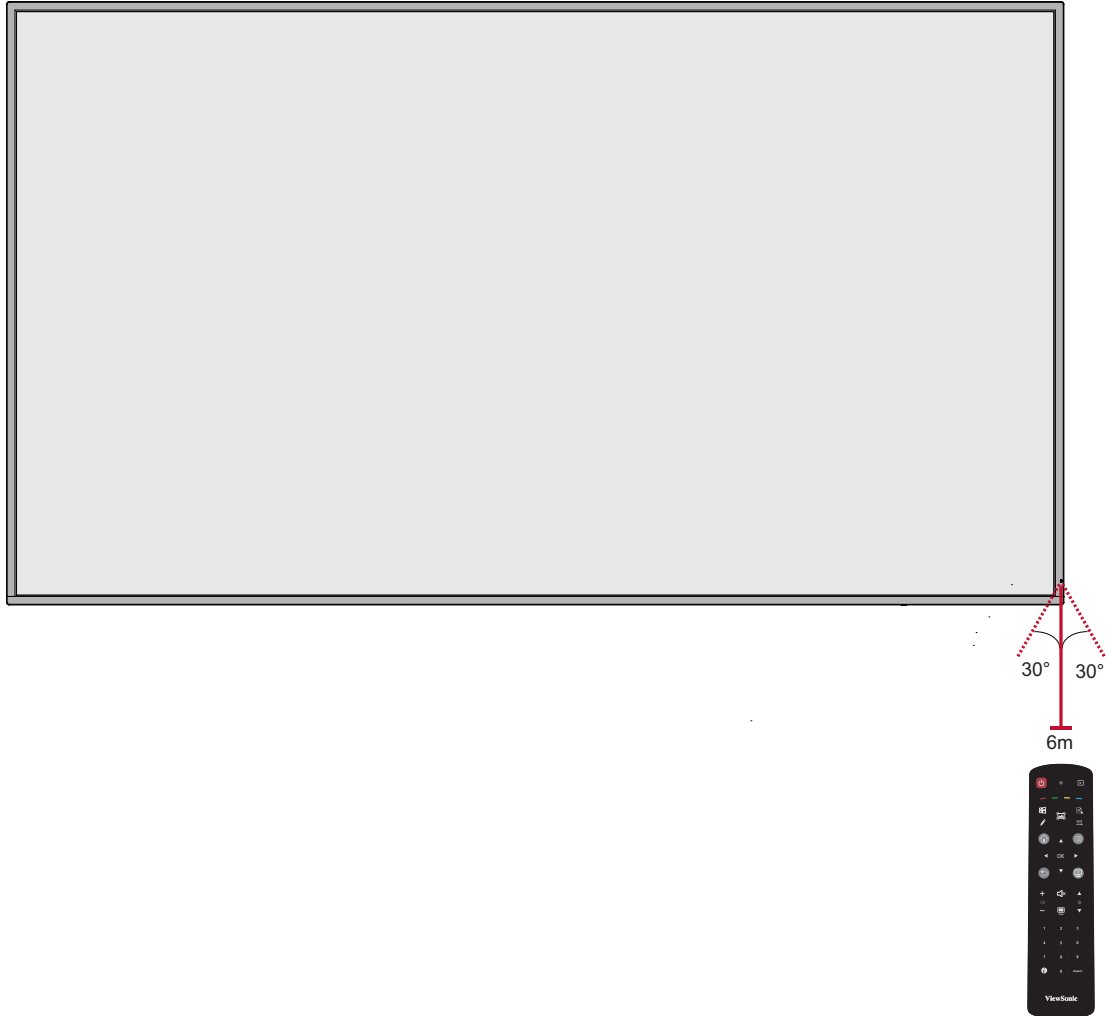

Making Connections

Connecting External Devices

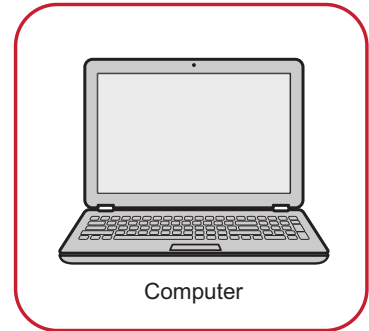
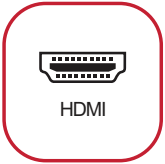
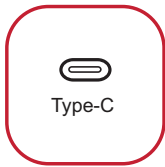

Your external device(s) can be connected in any of the following configurations:

USB Type-C Connection

To connect via USB Type-C:

Connect a USB Type-C cable from your external device to the Type-C port on the display.

HDMI Connection

To connect via HDMI:

Connect an HDMI cable from your external device to the HDMI port on the display.

RS-232 Connection

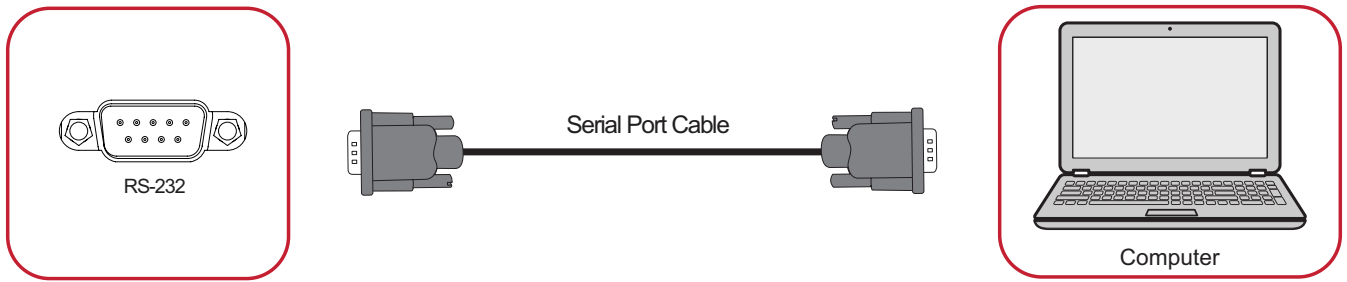

When you use a RS-232 serial port cable to connect your display to an external computer certain functions can be controlled remotely by the PC, including Power On/Off, Volume adjustment, Input select, Brightness, and more.

USB and Network Connections

Just like any PC, it is easy to connect various USB devices and other peripherals to your display.

USB Peripherals

Plug the USB device cable into the **USB** port.

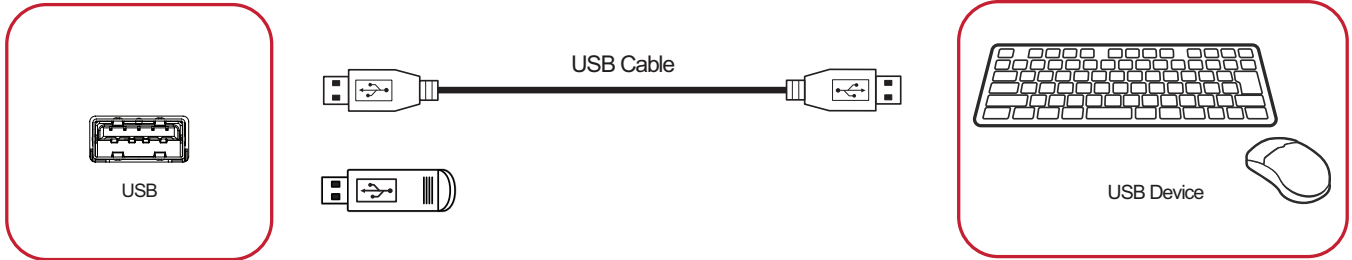

Networking and Modem cables

Plug the network cable into the **LAN** port.

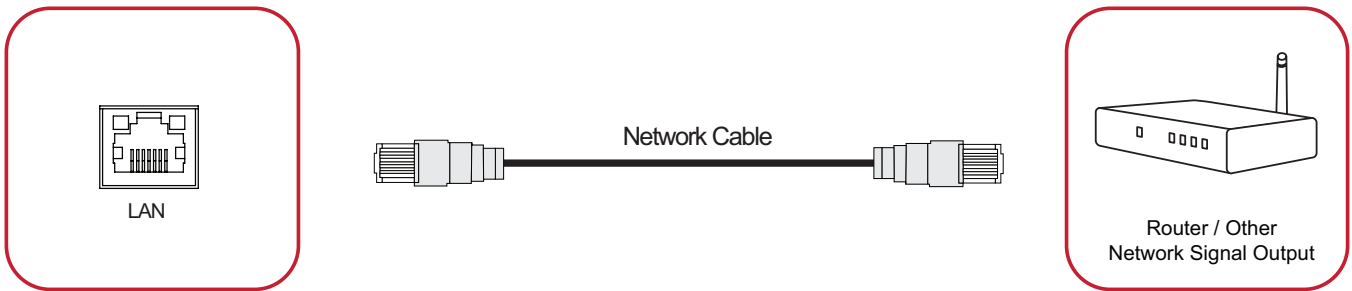

Media Player Connection

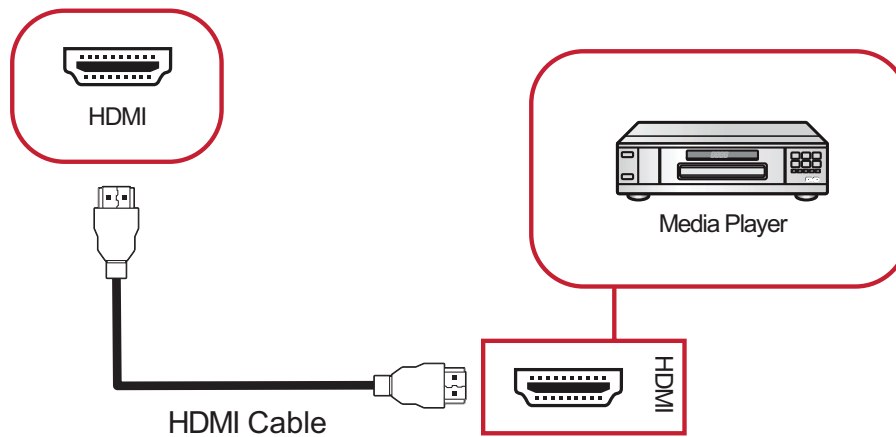

To connect to a media player via HDMI:

1. Connect an HDMI cable to the **HDMI** ports on your display and peripheral device.
2. Plug in the power cord of your display, and turn on the power supply switch.
3. Press the **Power** button on the display to turn the screen on.
4. Press the **INPUT** button on the remote control and switch to the "HDMI" input source.

SPDIF Connection

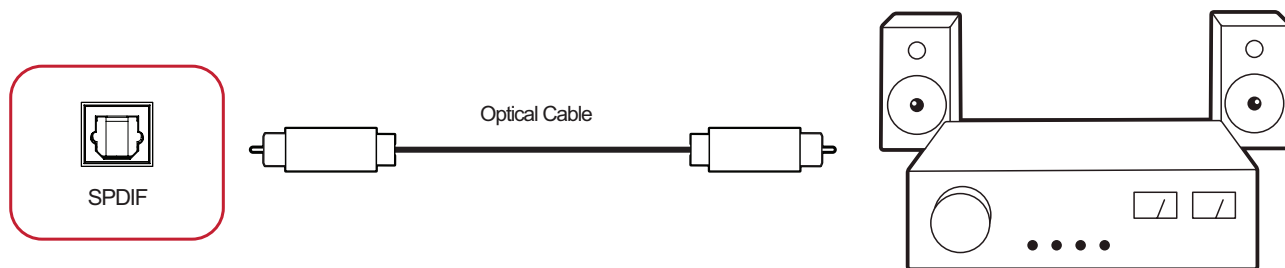

To connect to an external sound system:

1. Connect an optical cable from the **SPDIF** port on the display to your sound system's optical connector.
2. Plug in the power cord of your display, and turn on the power supply switch.
3. Press the **Power** button on the display to turn the screen on.

Video Output Connection

To output video via an external display device, connect an HDMI cable to the HDMI IN port of your external display device, and the other end to the **HDMI OUT** port of the display.

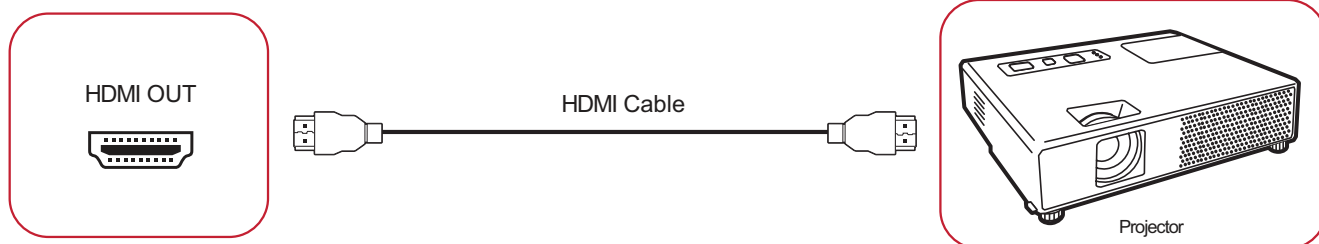

Using Your Display

Powering On/Off Your Display

1. Ensure the power cord is connected, plugged into a power outlet, and the power switch is in the “On” position.

NOTE: The AC IN socket is located at the rear, and the Power Switch is located underneath the display.

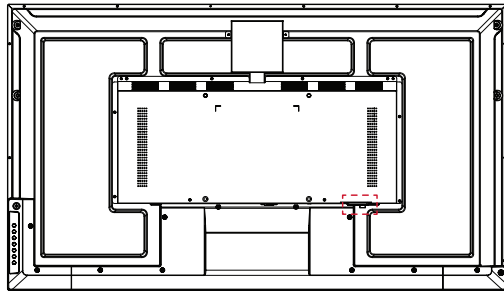

CDE4330

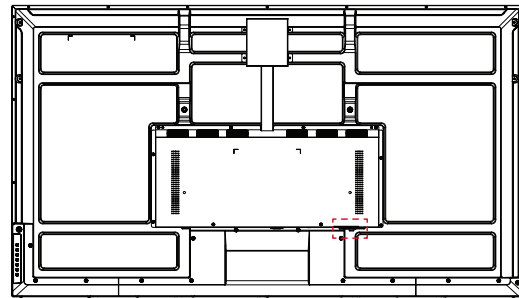

CDE5530

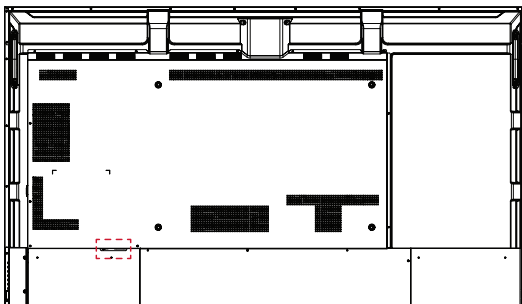

CDE6530

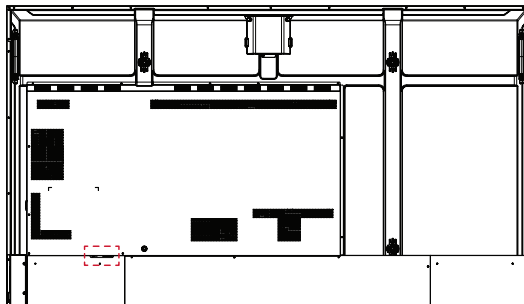

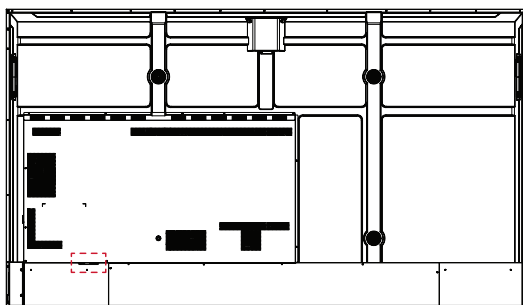

CDE7530

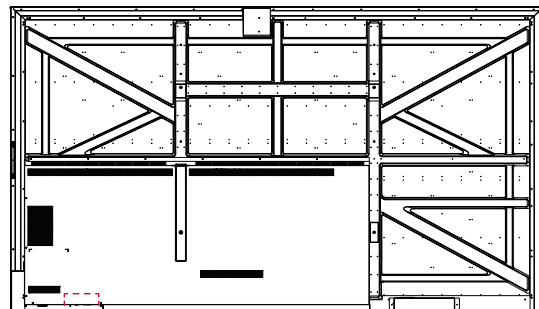

CDE8630



CDE9830

2. Press the  Power button to turn on the display.
3. To turn the display off, press the  Power button.

Initial Launch Setup

When you first turn on your display, an initial setup wizard will launch.

1. Select your Language.

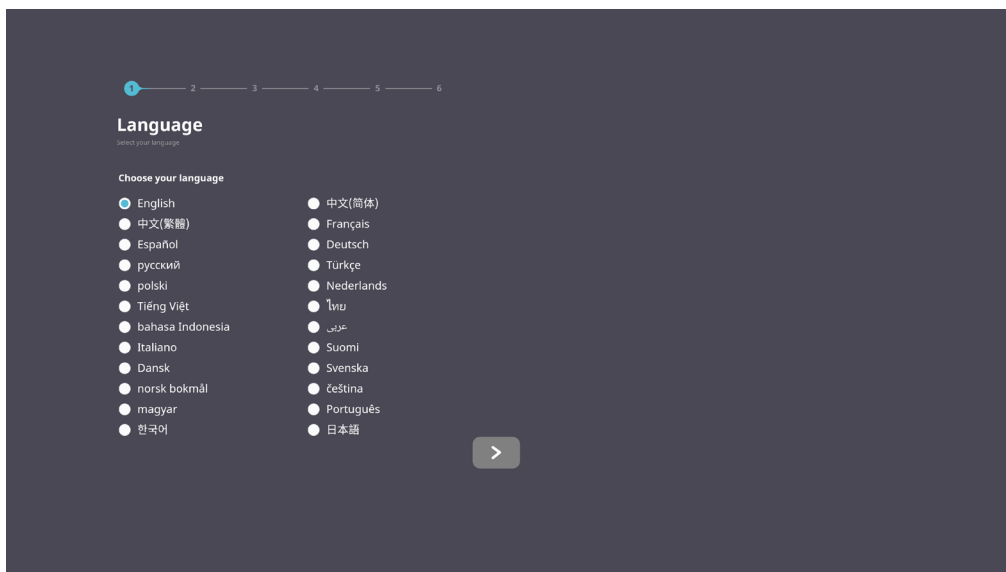

2. Select your Network.

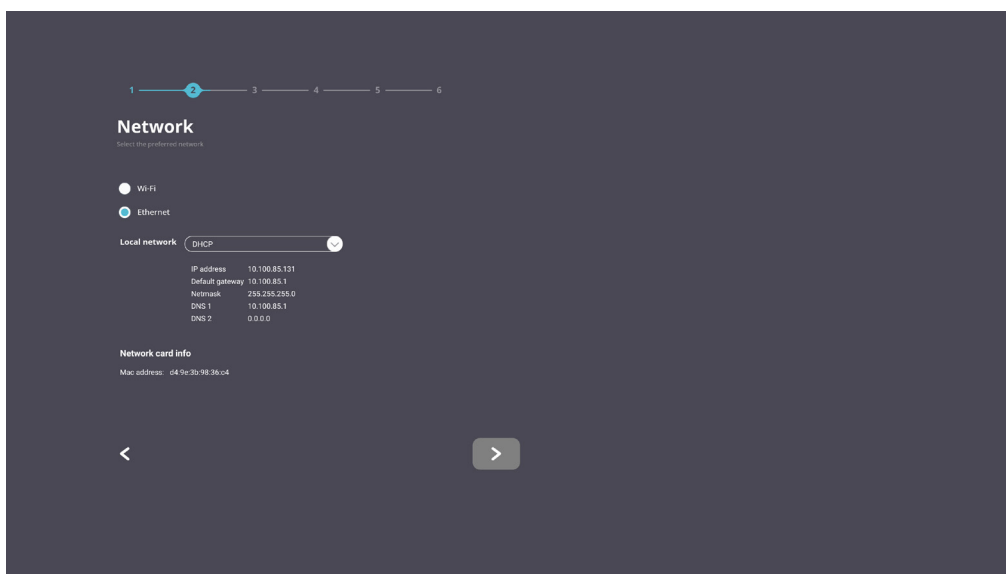

3. Select your Time Zone.

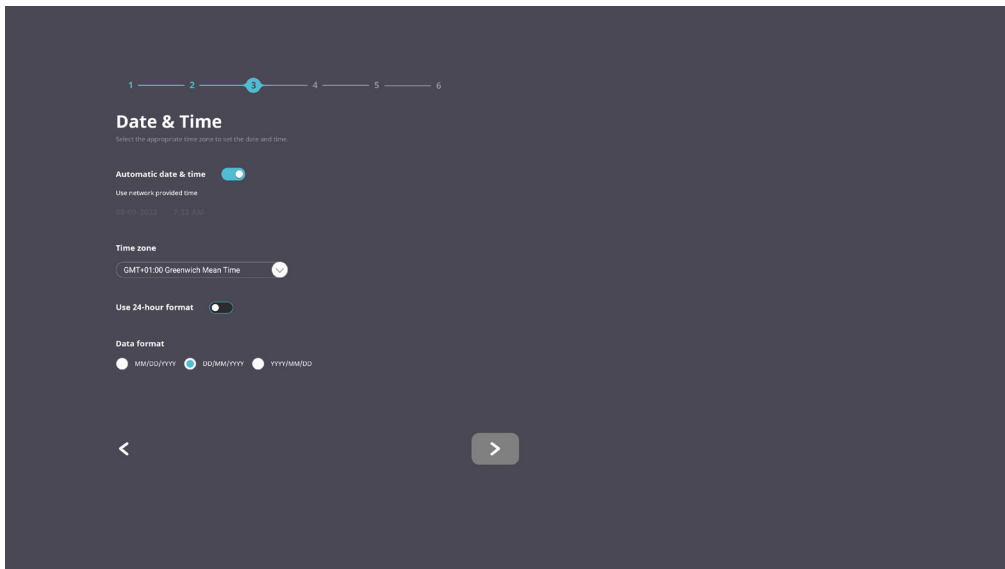

4. Select your Boot Mode.

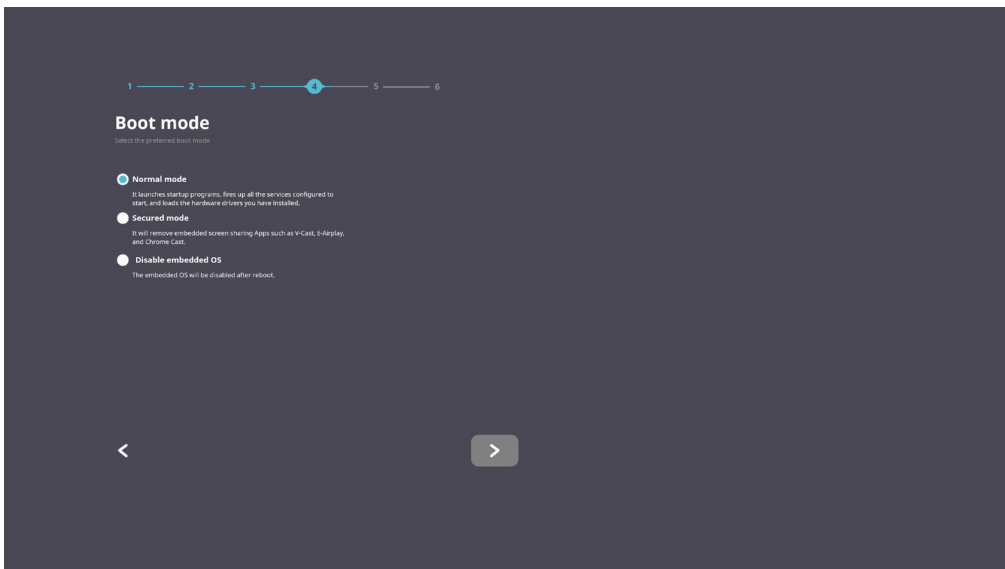

5. Select your Power Saving Mode.

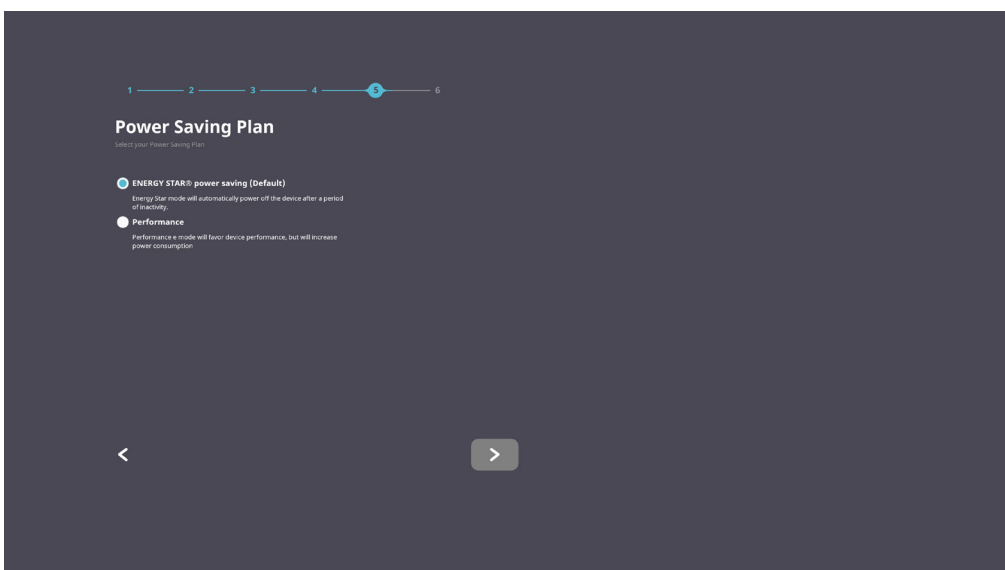

6. Accept or Decline Privacy and Copyright Protection.

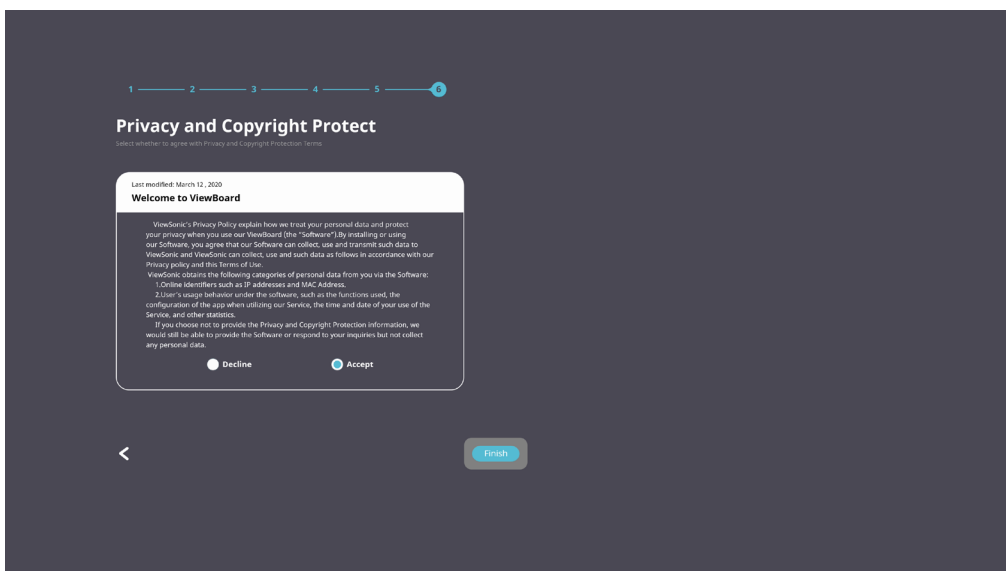

Home Screen

From the **Home Screen** all the installed applications can be accessed.

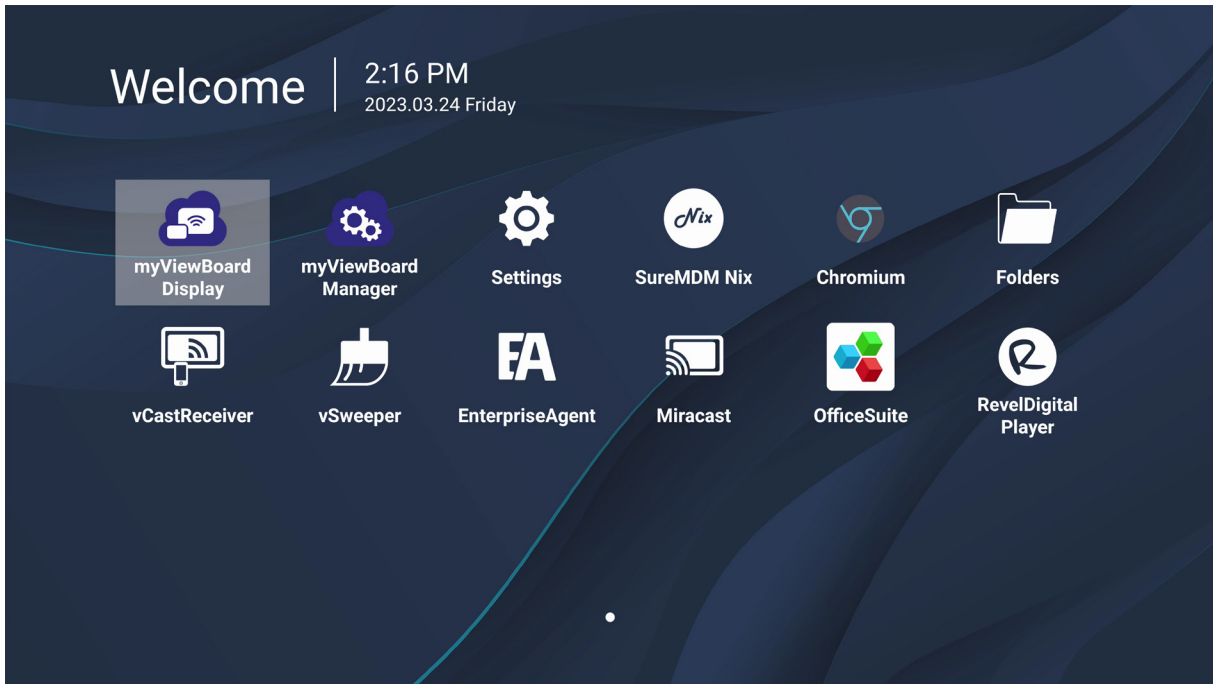

NOTE: Press the **Home** button on the remote control at any time to return to the **Home Screen**.

General Settings

Configure basic Network, Device, and System settings.



Network

Configure Ethernet, Wi-Fi, Wireless Hotspot, and Bluetooth settings.

Ethernet

- Enable/Disable Ethernet.

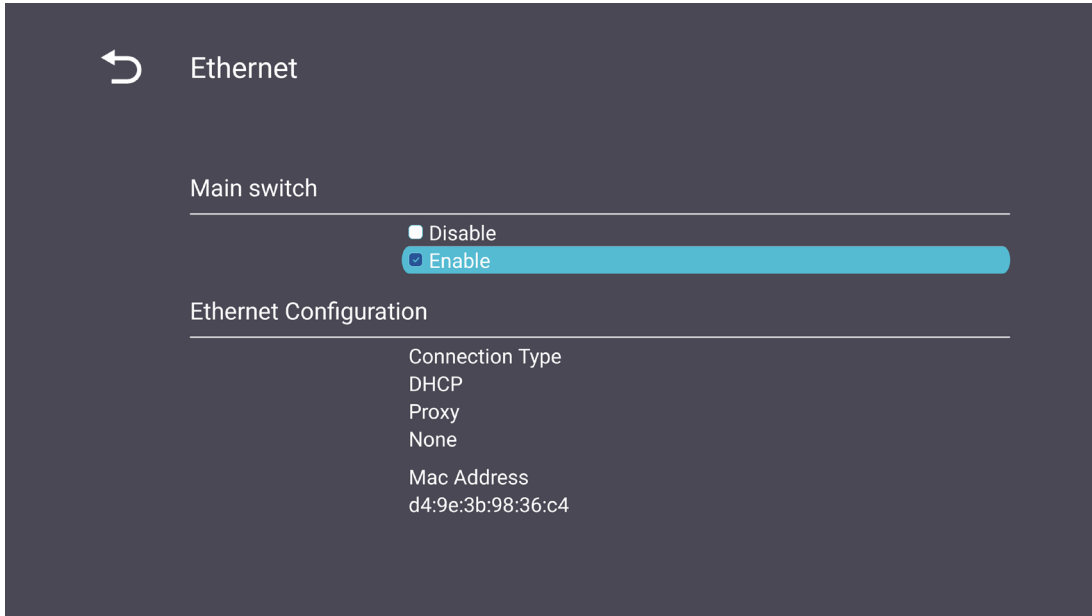

NOTE: After Ethernet is Enabled, the Connection Type and MAC Address will be available.

- Adjust the Connection Type.

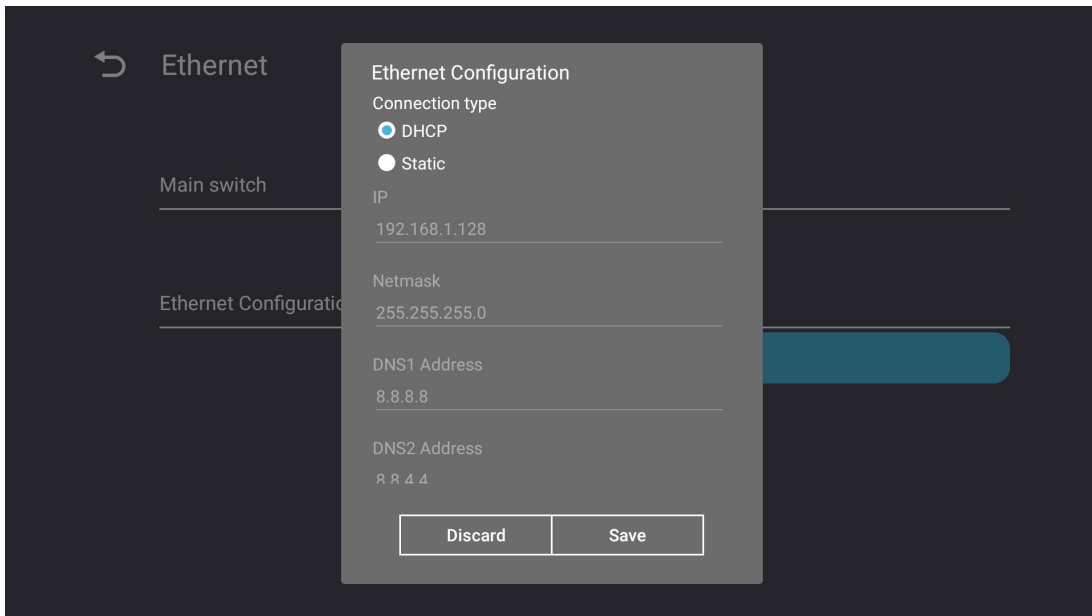

Connection Type	Description
DHCP	Cannot modify IP Address, Netmask, DNS Address and Gateway.
Static IP	Can input IP Address, Netmask, DNS Address and Gateway.

Wi-Fi

- Enable/Disable Wi-Fi.
- Add a Wi-Fi network or choose from the available listed.

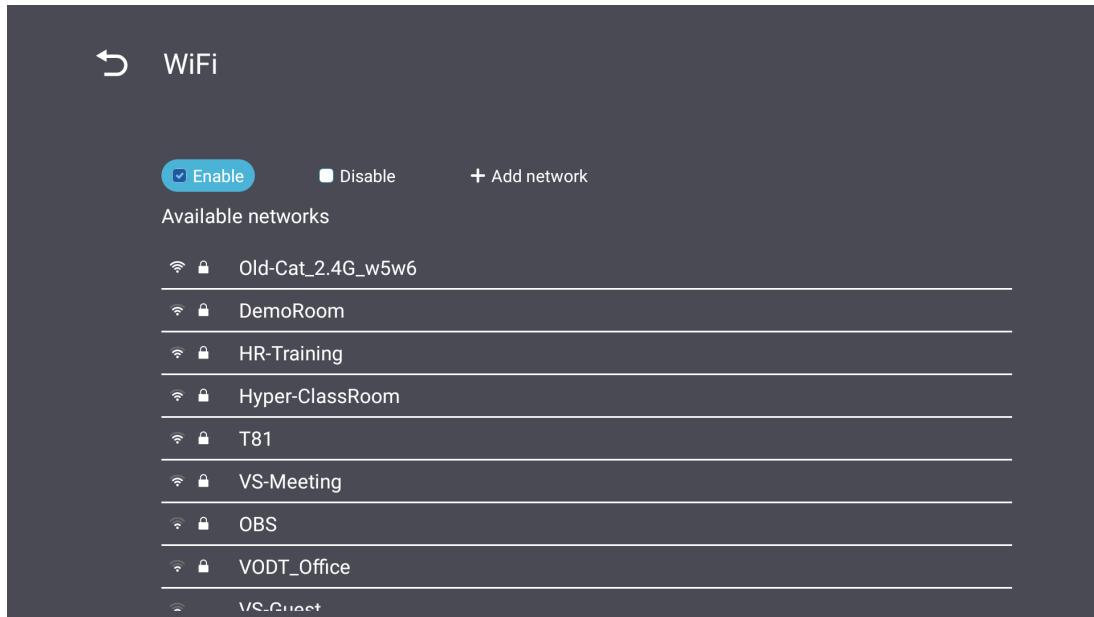

NOTE: After Wi-Fi is Enabled, available networks will be listed.

Wireless Hotspot

- Enable/Disable Wireless Hotspot.
- Share an internet connection with your devices once enabled.

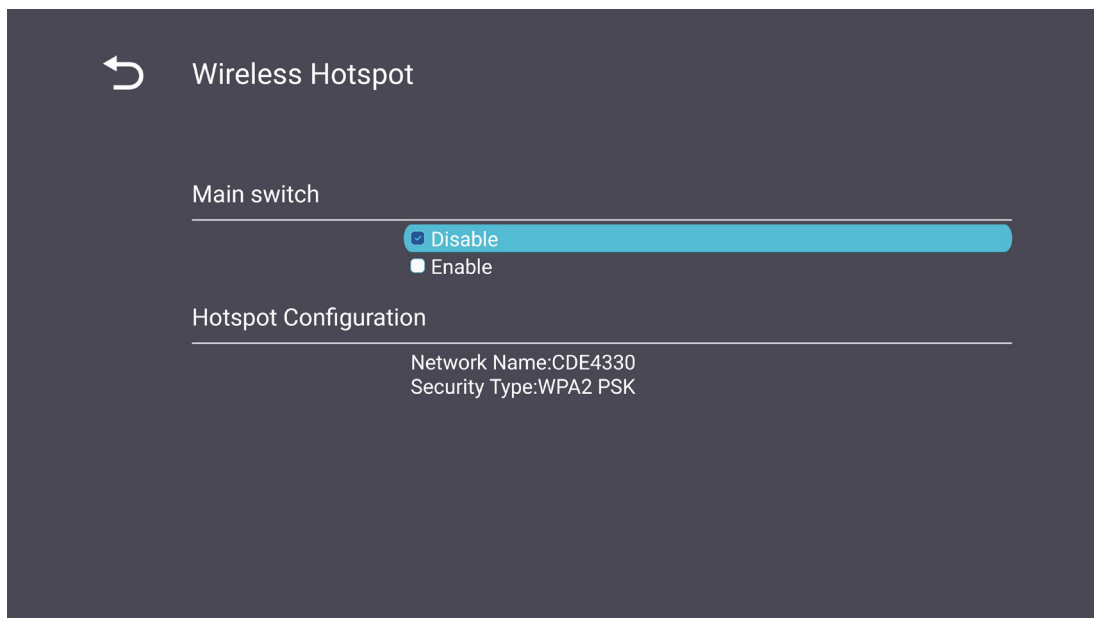

Bluetooth

- Enable/Disable Bluetooth.

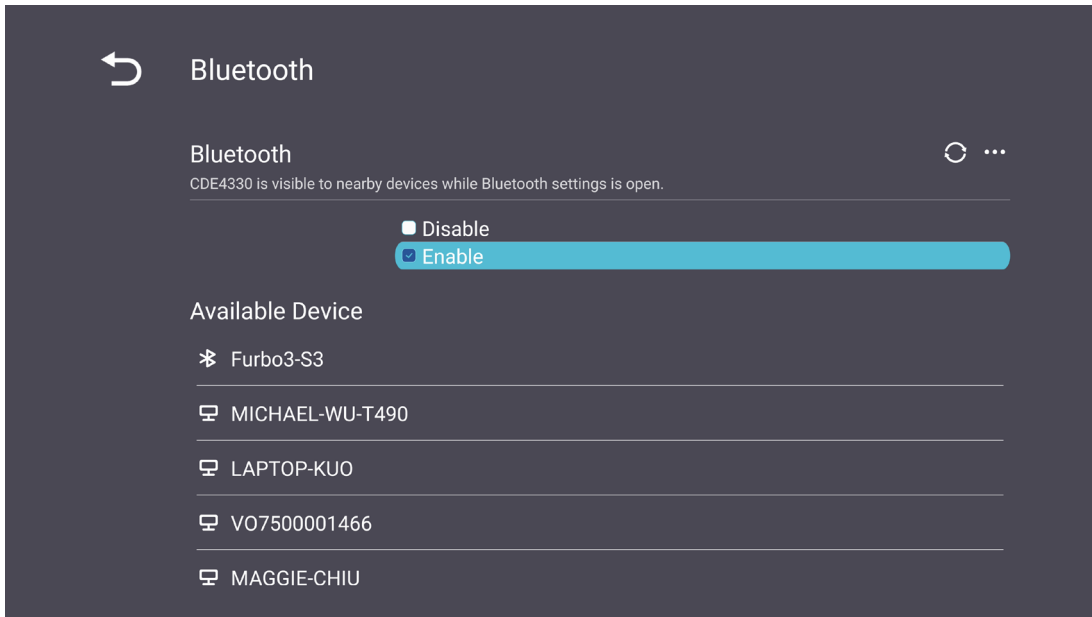

Miracast

- Enable/Disable Miracast.

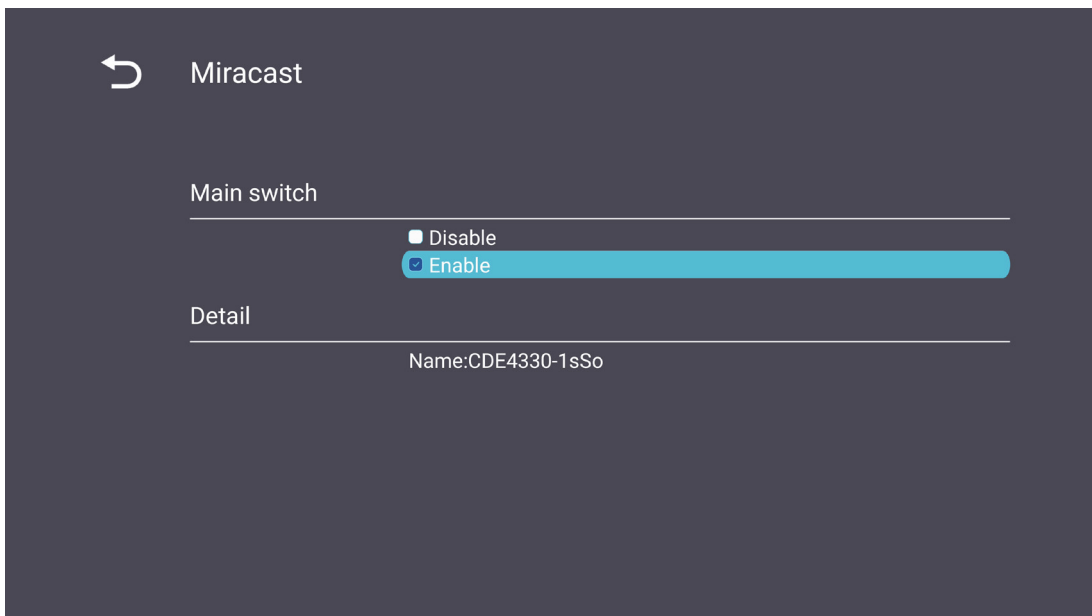

Device

Configure Signage Display, System Tools, Display, Apps, and Physical Keyboard settings.

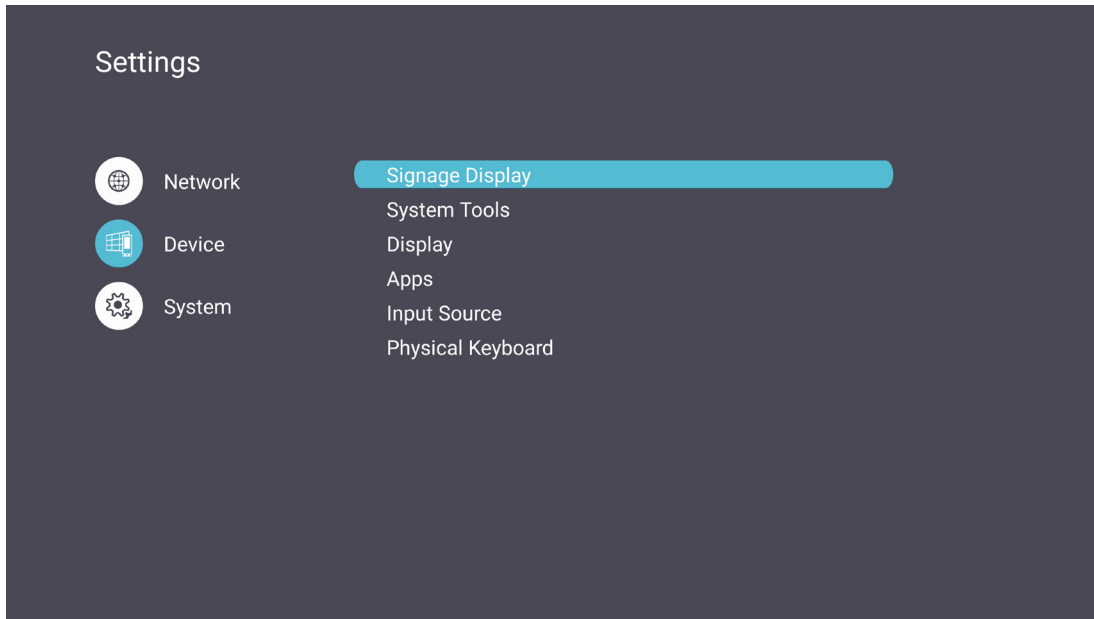

Signage Display

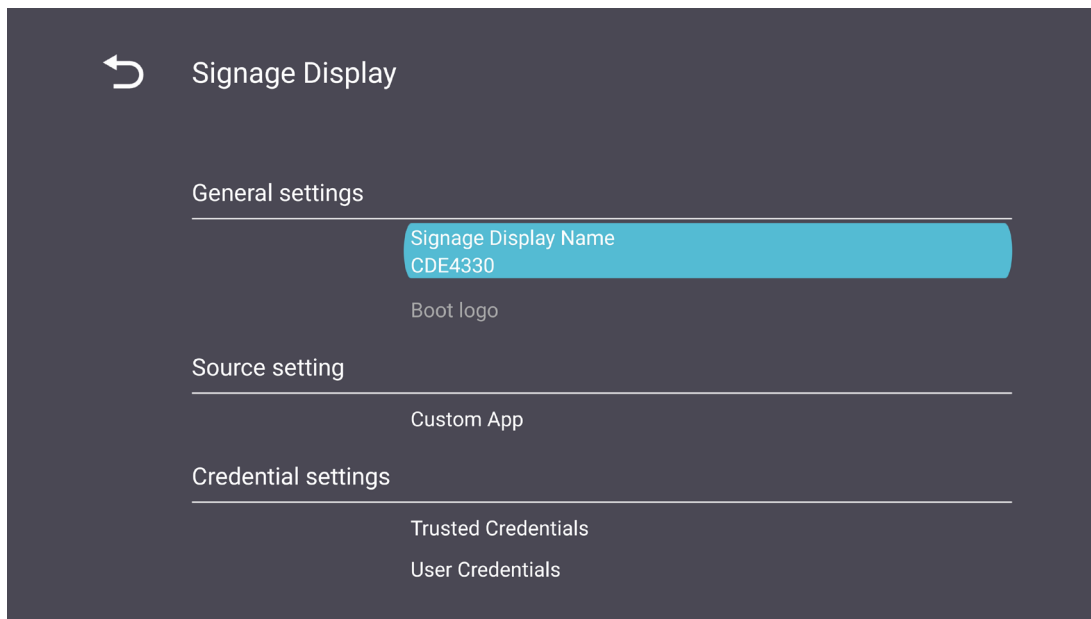

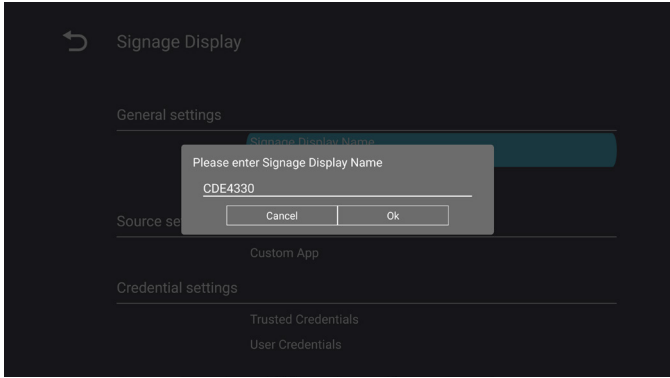
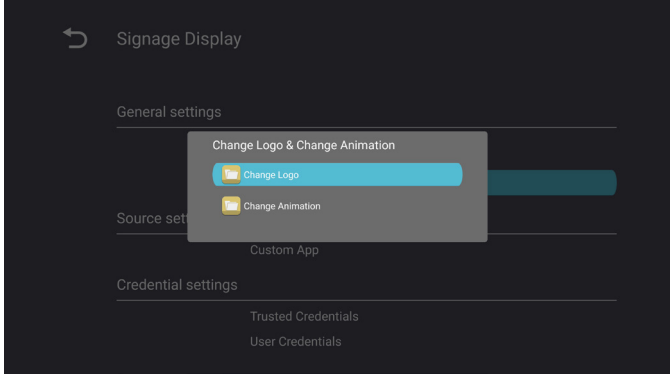
Item	Description
<p>General Settings</p>	<p><u>Signage Display Name</u> Setup the display's name. Maximum of 36 characters.</p>  <p><u>Boot Logo</u></p> <ul style="list-style-type: none"> • Enable/Disable the boot logo. • Select a custom boot logo or animation file.  <p>NOTE: Ensure “Boot on logo” in the Advanced settings of the OSD Menu is set to “User” to be able to select a custom boot logo or animation file.</p>

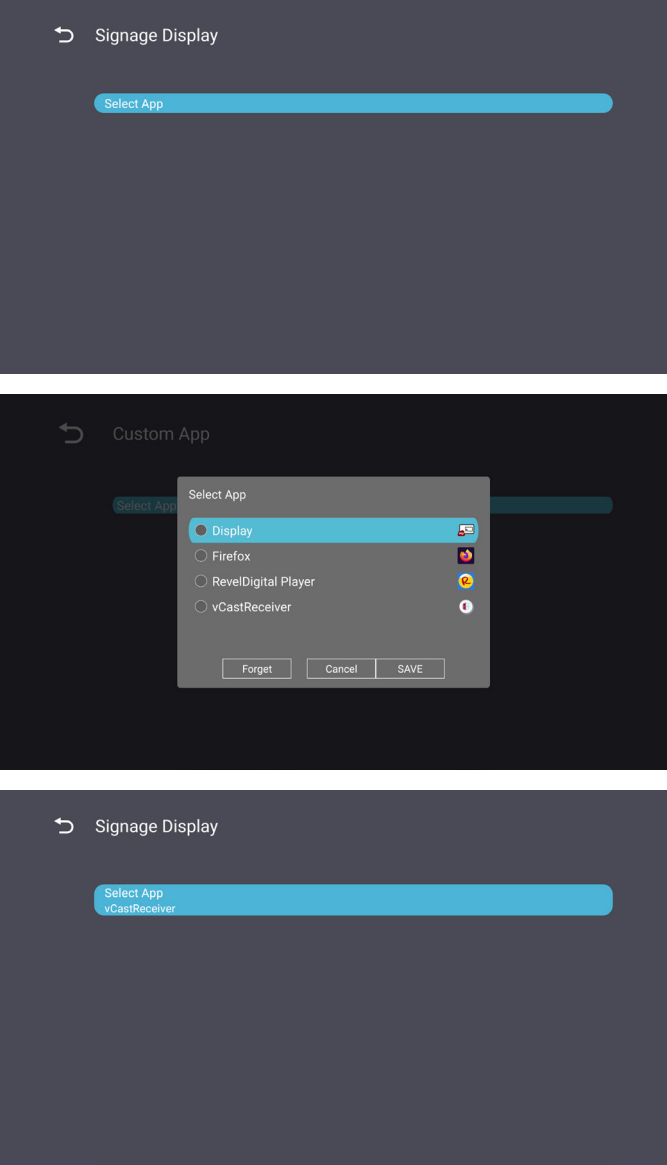
Item	Description
<p style="text-align: center;">Source Setting</p>	<p><u>Custom App</u></p> <p>Setup a custom .apk application for Custom input source. If a Custom App is setup, the display will open the App when the input source is changed to “Custom”.</p> 
<p style="text-align: center;">Security</p>	<p><u>External Storage</u></p> <p>Enable/Disable USB storage.</p> <p>NOTE: Re-insert any connected USB external storage device(s) after enabling.</p> <p><u>Unknown Sources</u></p> <p>Allow or don't allow the installation of unknown .apk files.</p>

System Tools

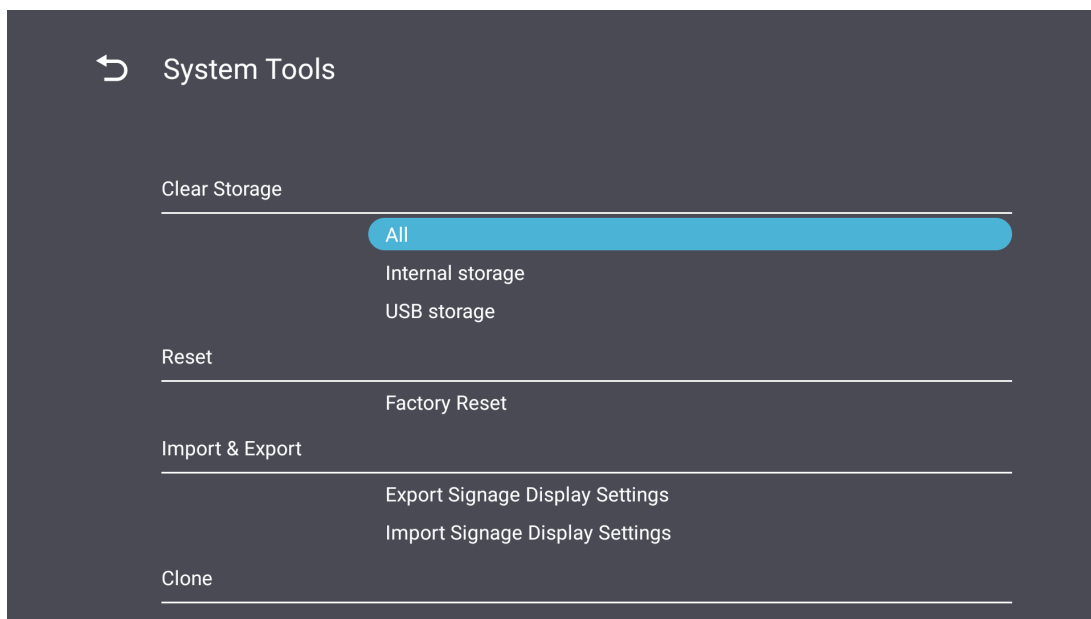

Item	Description
<p>Clear Storage</p>	<p><u>All</u> Clear all folder data.</p> <p><u>Internal Storage</u> Only clear internal storage folder data.</p> <p><u>USB Storage</u> Only clear USB storage folder data.</p>
<p>Reset</p>	<p><u>Factory Reset</u> Return to factory default settings.</p> <div data-bbox="649 1308 1319 1682" style="border: 1px solid black; padding: 10px; background-color: #333; color: white; margin-top: 10px;"> <p>↩ Factory Reset</p> <p>This will erase all data from your device's internal storage, including:</p> <ul style="list-style-type: none"> · System and app data and settings · Downloaded apps · Music · Photos · Video · Other user data <p>Erase all your personal information and downloaded apps? You can't reverse this action! The system will reboot later!</p> <p style="text-align: center;">FACTORY RESET</p> </div>

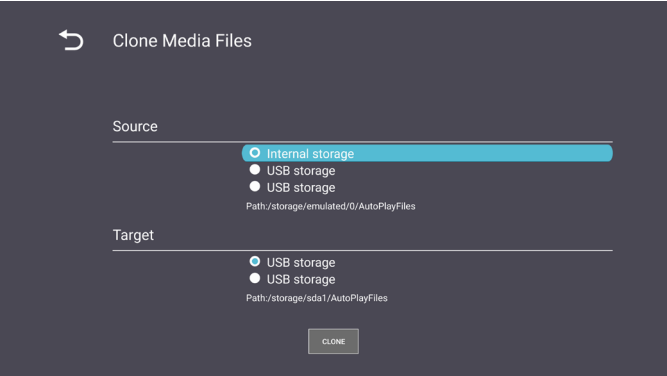
Item	Description
<p>Import & Export</p>	<p><u>Export Signage Display Settings</u> Export display settings to a USB.</p> <p>NOTE:</p> <ul style="list-style-type: none"> • The saved file name will be: vs8386SettingFile.txt • File will be saved in a folder titled “ViewSonic”. If one does not exist, it will be created. <p><u>Import Signage Display Settings</u> Import display settings from a USB.</p>
<p>Clone</p>	 <p>Create a copy of media files from the internal storage folder “AutoPlayFiles”.</p> <p><u>Source</u> Choose the media files copy location (Internal Storage or USB).</p> <p><u>Target</u> Select Internal Storage or USB as the target for the copied media files.</p>

Display

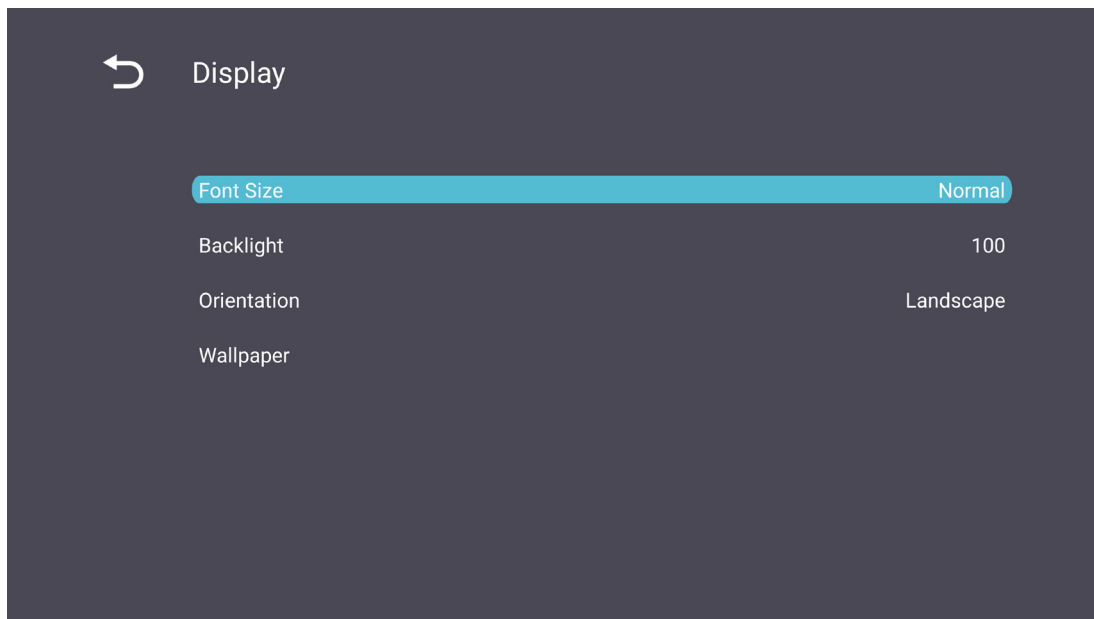

Item	Description
Font Size	Adjust the display's font size.
Backlight	Adjust the brightness of the display.
Orientation	Select landscape or portrait mode.
Wallpaper	Choose a background image for the display.

Apps

- View any running or installed applications. Select them for more detailed information and options.
- By selecting a running application, more information will be displayed, and the application can be stopped or reported.

The screenshot displays the 'Apps' management screen. At the top, there is a back arrow and the title 'Apps'. Below this are four tabs: 'Running' (selected), 'All', 'Download', and 'USB storage'. A progress bar indicates '1.67GB of 3.83GB RAM Used'. Below the bar, a legend shows 'System(1.27GB)' in black, 'Apps(408.96MB)' in blue, and 'Available(2.15GB)' in white. The 'App RAM usage' section lists the following applications:

App Name	RAM Usage	Sort by name	Process Count	Toggle
vCastReceiver	103.89MB	OFF/ON	1 process	ON
Manager	74.03MB	OFF/ON	1 process	ON
OfficeSuite	73.38MB	OFF/ON	2 process	ON
Display		OFF/ON	1 process	OFF

System

Date & Time

Set the time zone and Auto Time settings.

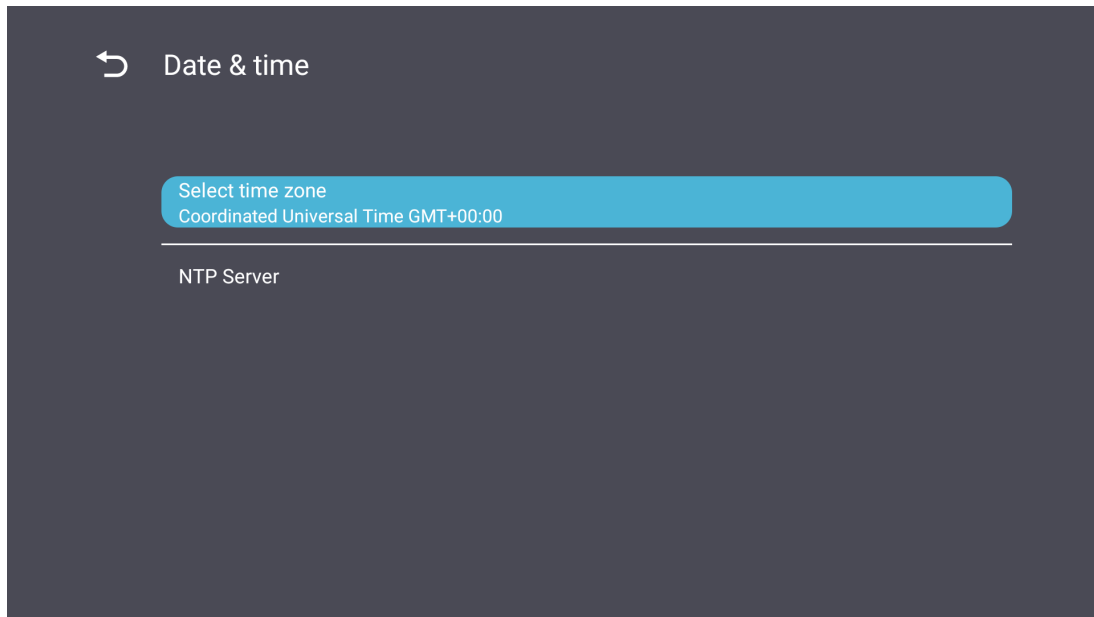

About

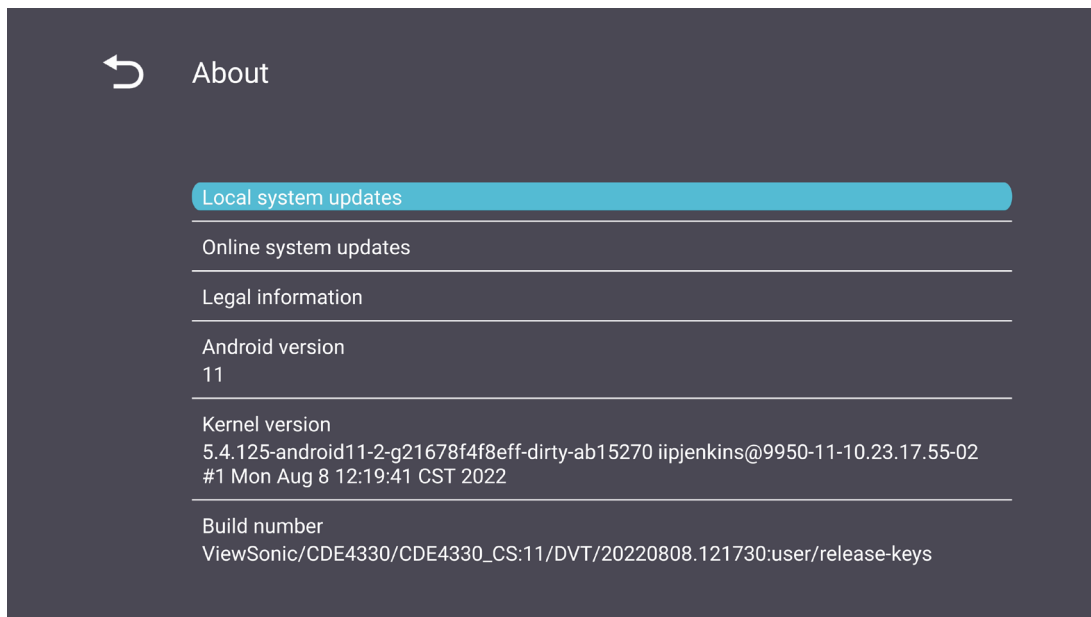

Item	Description
Online System Updates	When the display is off, the system will automatically check for a new version. If a new version is found, the system will automatically update. After the update is complete, the system will turn off.
Android Version	Current Android version information.
Kernel Version	Kernel version information.
Build Number	Build number information.

General Settings Menu Tree

Main Menu	Sub-menu	Menu Option	
Network	Ethernet	Enable/ Disable	
		Ethernet Configuration	Connection Type
			MAC Address
	Wi-Fi	Enable/ Disable	
		Add Wi-Fi	
	Wireless Hotspot	Enable/ Disable	
		Hotspot Configuration	
	Bluetooth	Enable/Disable	
		Available Devices	
	Miracast	Enable/Disable	
		Name	

Main Menu	Sub-menu	Menu Option		
Device	Signage Display	General Settings	Signage Display Name	
			Boot Logo	
		Source Setting	Custom App	
		Credentials Settings	Trusted Credentials	
			User Credentials	
			Install from Storage	
			Clear Credentials	
		Security	External Storage	
			Unknown Sources	
			Privacy and Copyright Protection	
			App Authority	
		System Tools	Clear Storage	All
				Internal Storage
	USB Storage			
	Reset		Factory Reset	
	Import & Export		Export Signage Display Settings	
			Import Signage Display Settings	
	Clone	Clone Media Files		
	Display	Font Size		
		Backlight		
		Orientation		
		Wallpaper		
	Apps			
Physical Keyboard				
System	Date & Time	Select Time Zone		
		NTP Server		
	About	Online System Updates		
		Legal Information		
		Android Version		
		Kernel Version		
		Build Number		

On-Screen Display (OSD) Menu

Access Picture, Screen, Audio, Time, Advanced, and About settings.

Navigating the OSD Menu using the Remote Control



1. On the remote control, press the **Settings** button (☰) to display the OSD Menu.
2. Use the directional buttons, ▼/▲/◀/▶ , to select menu items and adjust values.
3. Press the **Back** button(↶) to go back to the previous menu.
4. Press the **Settings** button (☰) again to exit the OSD Menu.

On-Screen Display (OSD) Menu Tree

Main Menu	Sub-menu
Picture	Brightness
	Contrast
	Sharpness
	Tint
	Color
	Noise Reduction
	Color Temperature
	Picture Mode
	Overscan
	RGB Range
	Blue Light Filter
	Picture Reset
	Screen
Screen Reset	
PIP	Sub Mode
	PIP Size
	PIP Position
	PIP Source
	PIP Audio
	PIP Reset
Tiling	Enable
	H Monitors
	V Monitors
	Position
	Frame Comp.
Audio	Balance
	Treble
	Bass
	Volume
	Mute
	Volume Control
	SPDIF Sync
	SPDIF Volume (Line Out)
	Audio Reset

Main Menu	Sub-menu
Time	Off Time
	Date and Time
	Schedule
	Slide Show Interval
	OSD Turn Off
	OSD Information
	Time Reset
Advanced	Panel Saving
	Power Save
	Power LED Light
	Boot on Source
	Boot on Logo
	Auto Signal Detection
	No Signal Standby
	HDMI with One Wire
	HDMI EDID
	USB Cloning
	USB Auto Play
	Switch On State
	WOL
	Monitor ID
	Language
Factory Reset	
About	Heat Status
	Display Information

Picture

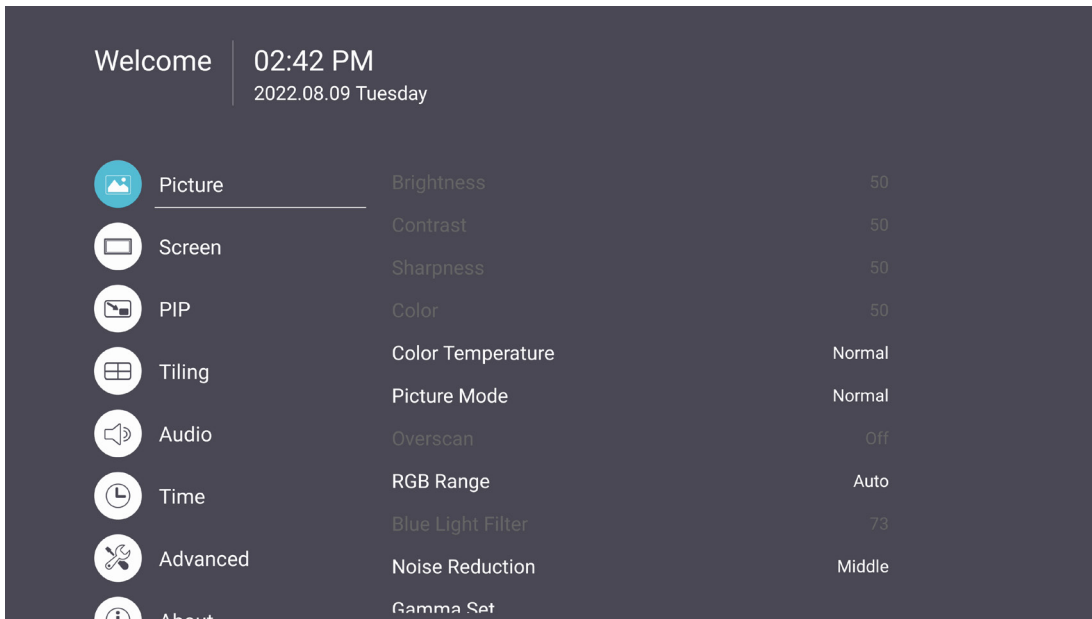

Item	Description
Brightness	Adjust the background black levels of the screen image.
Contrast	Adjust the degree of difference between the lightest and darkest parts of the picture and change the amount of black and white in the image.
Sharpness	Adjust the picture quality.
Tint	Adjust the lightness or darkness of the color shade.
Color	Adjust the amount of color present.
Noise Reduction	Reduce image noise and distortion.
Color Temperature	Adjust the color temperature.
Picture Mode	Select a predefined picture setting.
Overscan	Automatically enlarge the original picture horizontally and vertically to an equal aspect ratio that fills the screen.
RGB Range	Manually change the color format options to fit the correct color format range if the colors are not displayed correctly.
Blue Light Filter	Adjusts the filter that blocks high-energy blue light for a more comfortable viewing experience.
Picture Reset	Reset all Picture menu settings to default.

Low Blue Light Filter and Eye Health

The Blue Light Filter blocks high-energy blue light for a more comfortable viewing experience.

Calculating Breaks

When viewing screens for extended periods, it is recommended to take periodic breaks from viewing. Short breaks of at least 10 minutes are recommended after one (1) hour of continuous viewing.

Taking shorter, more frequent breaks are generally more beneficial than longer, less frequent breaks.

Focus Fatigue (20-20-20 Rule)

To reduce the risk of eye fatigue by constantly looking at the screen, look away from the screen at least every 20 minutes and gaze at a distant object (at least 20 feet away) for at least 20 seconds.

Looking at Distant Objects

While taking breaks, users can further reduce eye strain and dryness by focusing on objects that are further away from them for 10-15 seconds, then gaze at something up close for 10-15 seconds. Repeat this up to 10 times. This exercise reduces the risk of your eyes' focusing ability to "lock up" after prolonged computer work.

Eye and Neck Exercises

Eye Exercises

Eye exercises can help minimize eye strain. Slowly roll your eyes to the left, right, up, and down. Repeat as many times as needed.

Exercises for the eyes

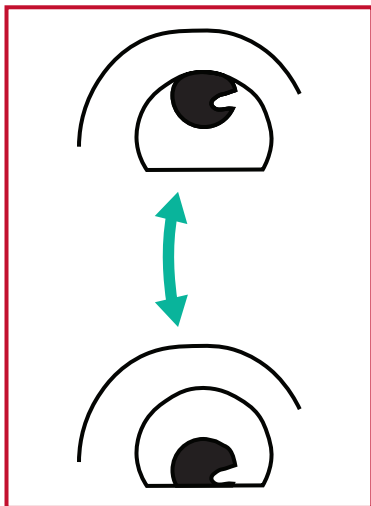

(1) Keep the body and the head upright. Move the eyes up to look at the ceiling, then turn down to look at the floor.

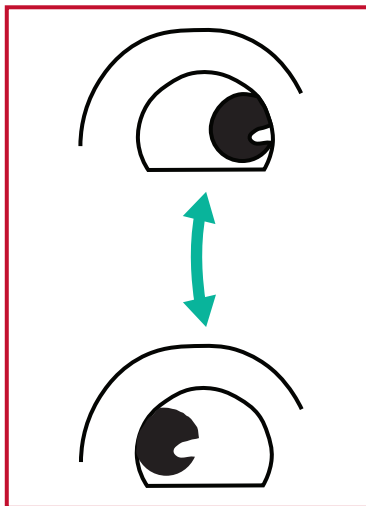

(2) Move the eyes left and right slowly to look at objects on the two sides.

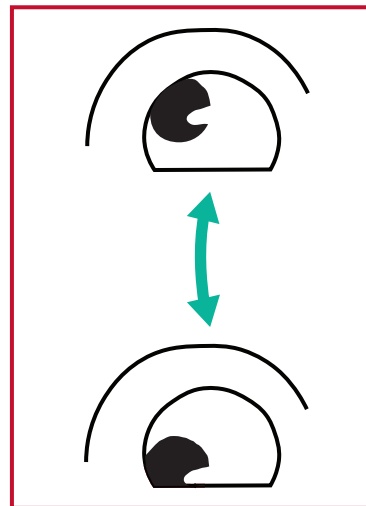

(3) Move the eyes to look at objects at the right upper direction and then right lower direction. Repeat for the left upper and left lower directions.

Neck Exercises

Neck exercises can also help minimize eye strain. Relax your arms and let them hang at your sides, bend forward slightly to stretch the neck, turn your head to the right and to the left. Repeat as many times as needed.

Flicker-Free

The CDE30 series uses DC-adjustable backlighting, which does not produce a visible or invisible flicker within the 0~3000 Hz range and therefore can reduce eye fatigue.

Screen

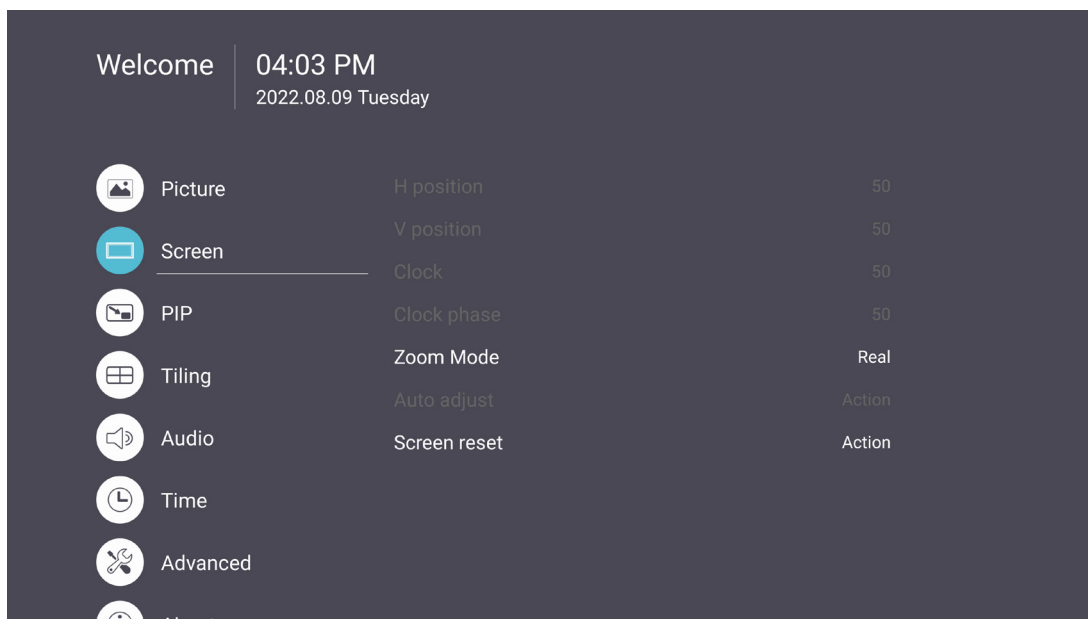

Item	Description
<p>Zoom Mode</p>	<p>Dynamically stretch and scale the image output to a different aspect than that of the image input signal.</p> <p><u>Full</u> Restores the correct proportions of pictures transmitted in 16:9 using the full screen display.</p> <p><u>Normal</u> The picture is reproduced in 4:3 format and a black band is displayed on either side of the picture.</p> <p><u>Real</u> This mode displays the image pixel-by-pixel on screen without scaling the original image size.</p>
<p>Screen Reset</p>	<p>Reset all Screen menu settings to default.</p>

Item	Description
PIP	<p><u>Sub Mode</u> Select the PIP (Picture-in-Picture) mode. Choose from: Off, PIP, PBP.</p> <p><u>PIP Size</u> Select the size of the sub picture in the PIP (Picture-in-Picture) mode. Choose from: Small, Medium, Large.</p> <p><u>PIP Position</u> Select the position of the sub picture in the PIP (Picture-in-Picture) mode. Choose from: Bottom-Right, Bottom-Left, Top-Right, Top-Left.</p> <p><u>PIP Source</u> Select the input signal for the sub-picture.</p> <p><u>PIP Audio</u> Select the audio source for the Sub Mode.</p> <ul style="list-style-type: none"> • Main - Select audio from the main picture • Sub - Select audio from the sub-picture. <p><u>PIP Reset</u> Reset all settings in the PIP menu to factory preset values.</p>
Tiling	<p><u>Enable</u> Choose ON or OFF for the Tiling function. If ON, the display will apply the settings in H Monitors, V Monitors, Position, and Frame Compensation.</p> <p><u>H Monitors</u> Adjust displays on the horizontal side.</p> <p><u>V Monitors</u> Adjust displays on the vertical side.</p> <p><u>Position</u> Adjust the position of the display in the screen matrix.</p> <p><u>Frame Compensation</u> Choose to turn the frame compensation function on or off. If ON, the display will adjust the image to compensate for the width of the display bezels in order to accurately display the image.</p>

Audio

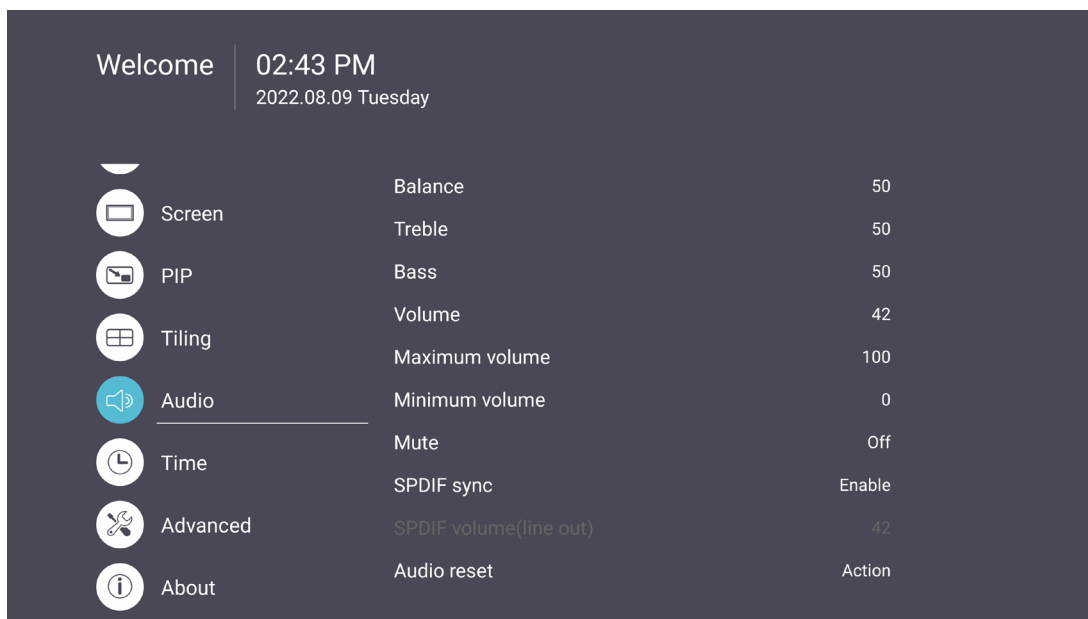

Item	Description
Balance	Adjust the left/right speaker balance.
Treble	Increase/decrease the treble level (higher-pitched sounds).
Bass	Increase/decrease the bass level (lower-pitched sounds).
Volume	Increase/decrease the display's volume level.
Mute	Mute the volume.
Volume Control	Select audio source from internal speaker or Audio Out port.
SPDIF Sync	Sync Audio Out volume with the display's speakers.
SPDIF Volume (Line Out)	Increase/decrease the Audio Out volume.
Audio Reset	Reset all Audio menu settings to default.

Time



Item	Description
Off Time	Set the auto power off time.
Date and Time	Adjust the date and time of the display.
Schedule	Set up to seven (7) different time intervals for the display to be active.
Slide Show Interval	Set the photo slide show interval for USB auto play.
OSD Turn Off	Set the time period the OSD Menu stays on the screen.
OSD Information	Set the time period the OSD information will be displayed in the upper left corner of the display.
Time Reset	Reset all Time menu settings to default.

Advanced



Item	Description
Panel Saving	Reduces the risk of Image Burn-in when enabled.
Power Save	Reduce power consumption. <u>Mode 1</u> TCP off, WOL on. <u>Mode 2</u> TCP off, WOL on, wake up by video signal resume. <u>Mode 3</u> TCP on, WOL off, wake up by video signal resume. <u>Mode 4</u> TCP on, WOL off, no wake up by video signal resume support.
Power LED Light	Turn On/Off the Power LED indicator.
Boot on Source	Select the input source after boot up.
Boot on Logo	Enable/Disable a logo when the display is turned on. <u>Off</u> Neither the ViewSonic nor animation logo will show. <u>On</u> The ViewSonic logo and animation will show. <u>User</u> If a custom logo option is set in General Settings , then the custom logo will show. If there is no custom logo set then no logo will show. For more information, see page 41.

Item	Description
Auto Signal Detection	Let the display detect and display available input sources automatically.
No Signal Standby	Set the time period to enter Standby Mode when there is no signal.
HDMI with One Wire	<p>Enable/Disable CEC (Consumer Electronics Control).</p> <p>CEC synchronizes power on/off operation via HDMI connection. That is, if a device that also supports CEC is connected to the HDMI input of the display, when the display's power is turned off, the power of the connected device will also be turned off automatically. When the power of the connected device is turned on, the display's power will be turned on automatically.</p>
HDMI EDID Version	Select HDMI EDID version: EDID 1.4, EDID 2.0, Auto.
USB Cloning	Save the OSD Menu configuration to the USB storage.
USB Auto Play	If set to ON, the display will copy media files from the external USB storage to the display's internal storage then play the media files automatically.
Switch on State	<p>Select the display status for the next time the power cord is connected to a power outlet.</p> <p><u>Power Off</u> The display will remain off when the power cord is connected.</p> <p><u>Forced On</u> The display will turn on when the power cord is connected.</p> <p><u>Last Status</u> The display will return to the previous power status.</p>
WOL	Enable/Disable the Wake on LAN (WOL) feature.
Monitor ID	<p>Assign a number to remote control the display by RS-232.</p> <p>NOTE: The number range is: 1~98; 99 is reserved for "All Displays".</p>
Language	Select OSD Menu language.
Factory Reset	Reset all OSD Menu settings to default.
Advanced Reset	Reset all Advanced menu settings to default.

About

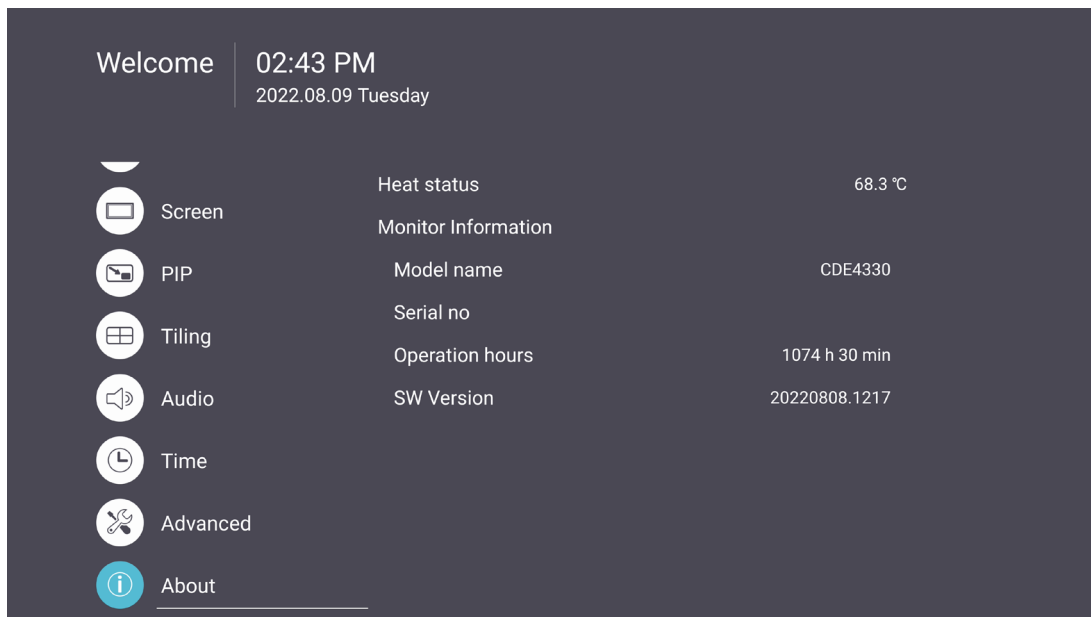

Item	Description
Heat Status	Check the temperature of the display.
Display Information	See information about the display: Model Name, Serial No., Operation Hours, and Software Version.

Embedded Applications and Settings

vCastReceiver & vCastSender

The vCastReceiver app, will allow the ViewBoard® to receive vCastSender laptop screens (Windows/Mac/Chrome) and mobile (iOS/Android) users' screens, photos, videos, annotations, and camera(s).

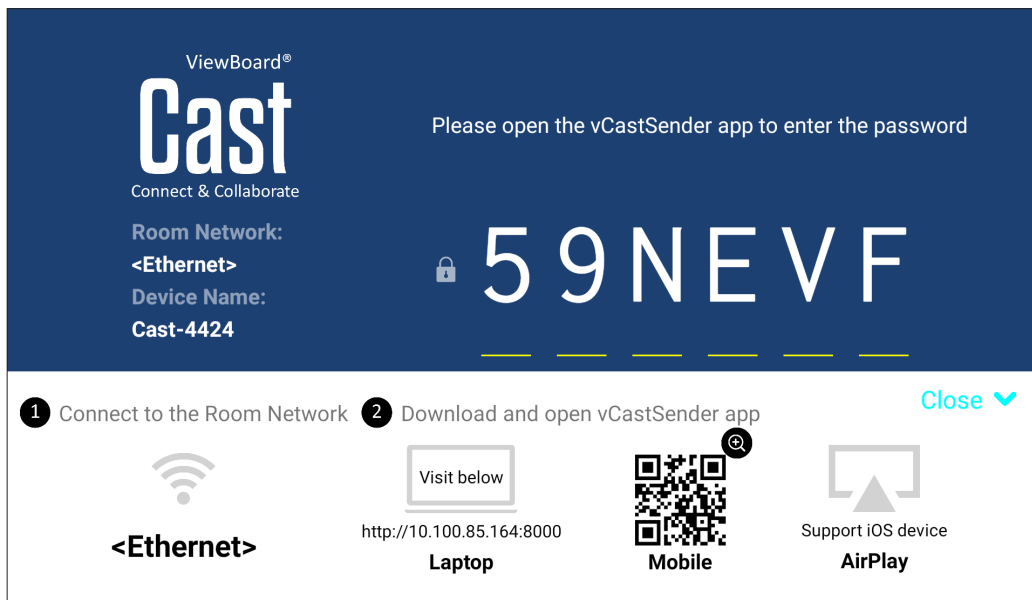

Network Information

- vCast software, laptops, and mobile devices can connect to both the same subnet and across the subnet network.
- Connected devices will show up under “Device List” on the same subnet connection.
- If the device does not show up under “Device List”, users will need to key-in the on-screen PIN-code.

vCast is a wireless peer to peer data communication, therefore the below port settings are required:

Ports:

- CP: 56789, 25123, 8121, and 8000
- UDP: 48689 and 25123

Port and DNS activation:

- Port: 443
- DNS: <https://vcastactivate.viewsonic.com>

OTA Service:

- Server Port: TCP443
- Server FQDN Name: <https://vcastupdate.viewsonic.com>

Cast Sender from Windows-based, Macbook, and Chrome devices.

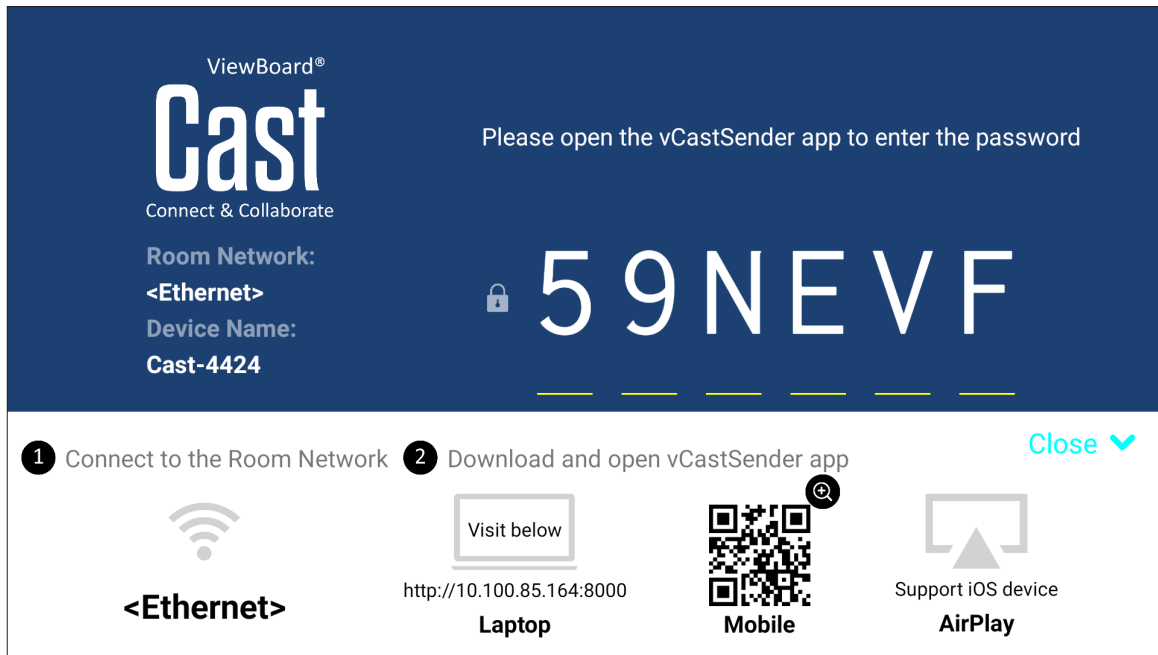

Mac, Windows, Chrome Devices:

1. Make sure your device is connected to the same network as the display.
2. Visit the address that is shown on the display to download the application.
3. Launch the application and enter the PIN Code or click Device List, then click the connect icon next to the Device Name.

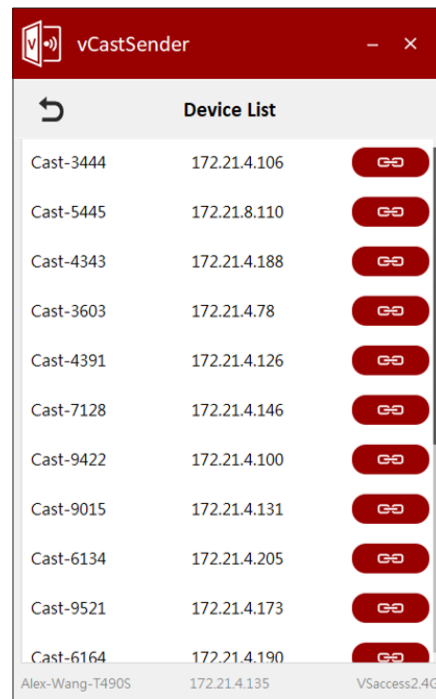
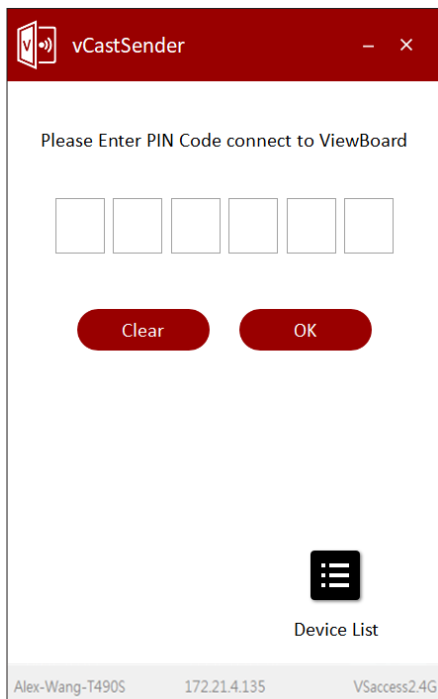

Cast Sender from Mobile Devices: iOS-based (iPhone, iPad) and Android OS based phone/tablet.

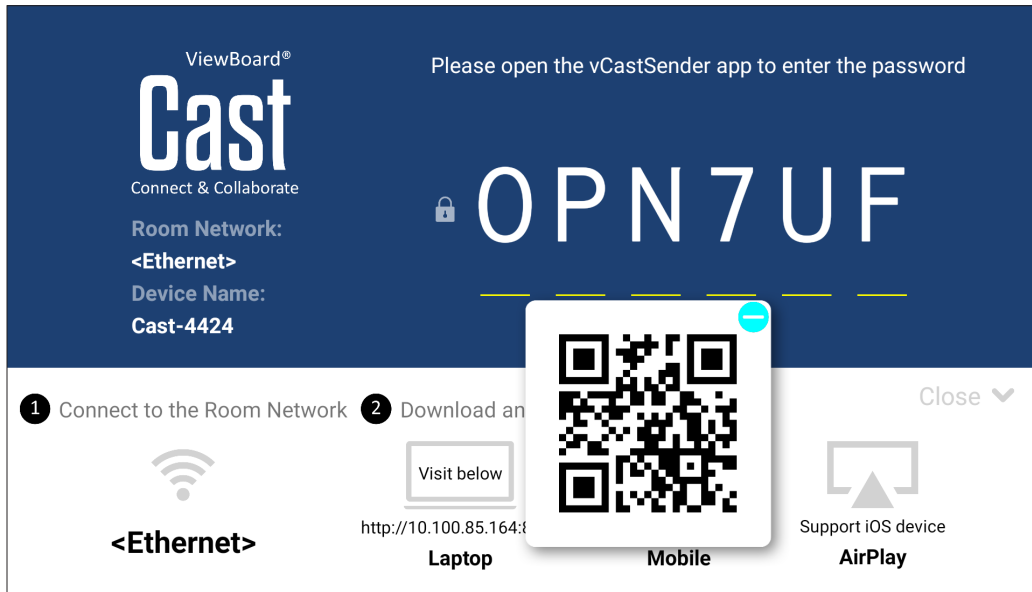

Android/iOS:

1. Make sure your device is connected to the same network as the display.
2. Scan the QR Code that is shown on the display to download directly from the server, or download from the Google Play Store or the Apple Store.
3. Launch the application and select the correct Device Name and input the pin to connect. You can also directly input the pin-code displayed on the display to connect.

Apple AirPlay®:

1. Make sure your device is connected to the same network as the display.
2. Directly open AirPlay and select the Device Name to connect.
3. Another "AirPlay Password" will be generated on-screen for connection.

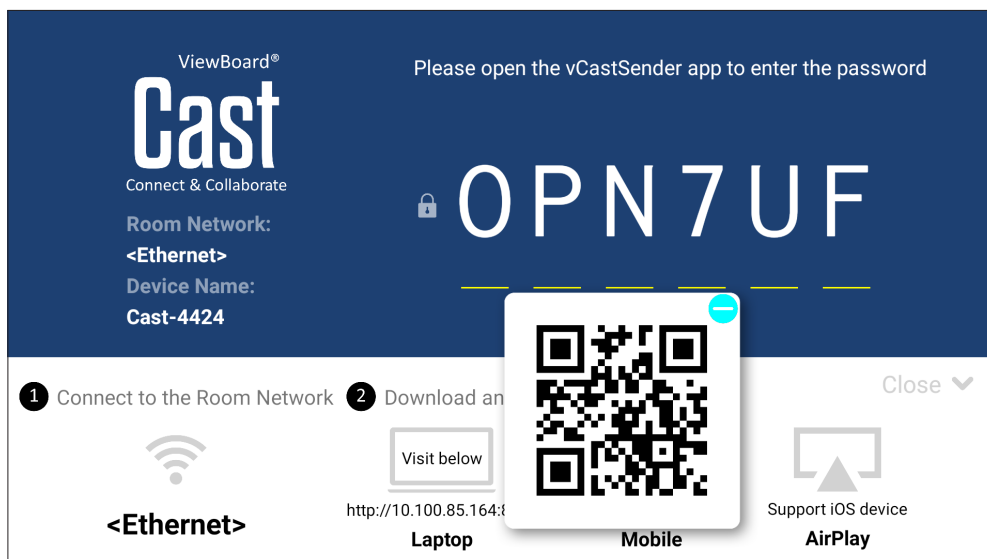

Other Default Applications

vSweeper

Clear unnecessary data and unwanted files.

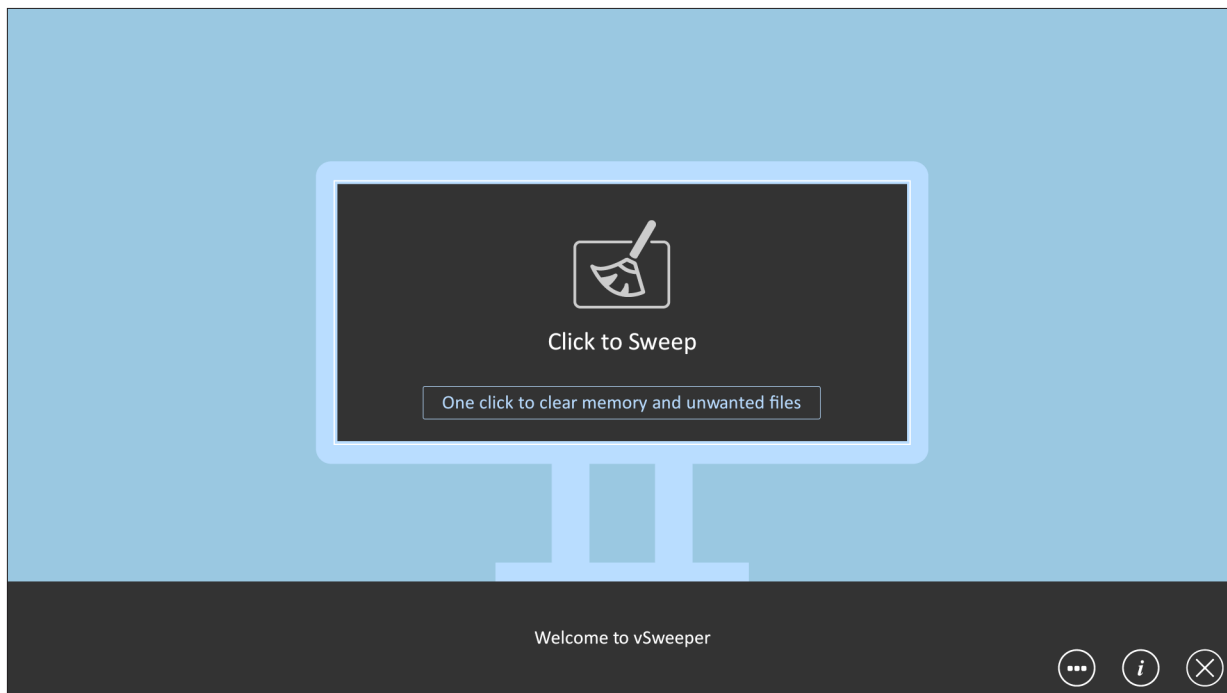

Advanced Settings can also be customized to the user's needs.

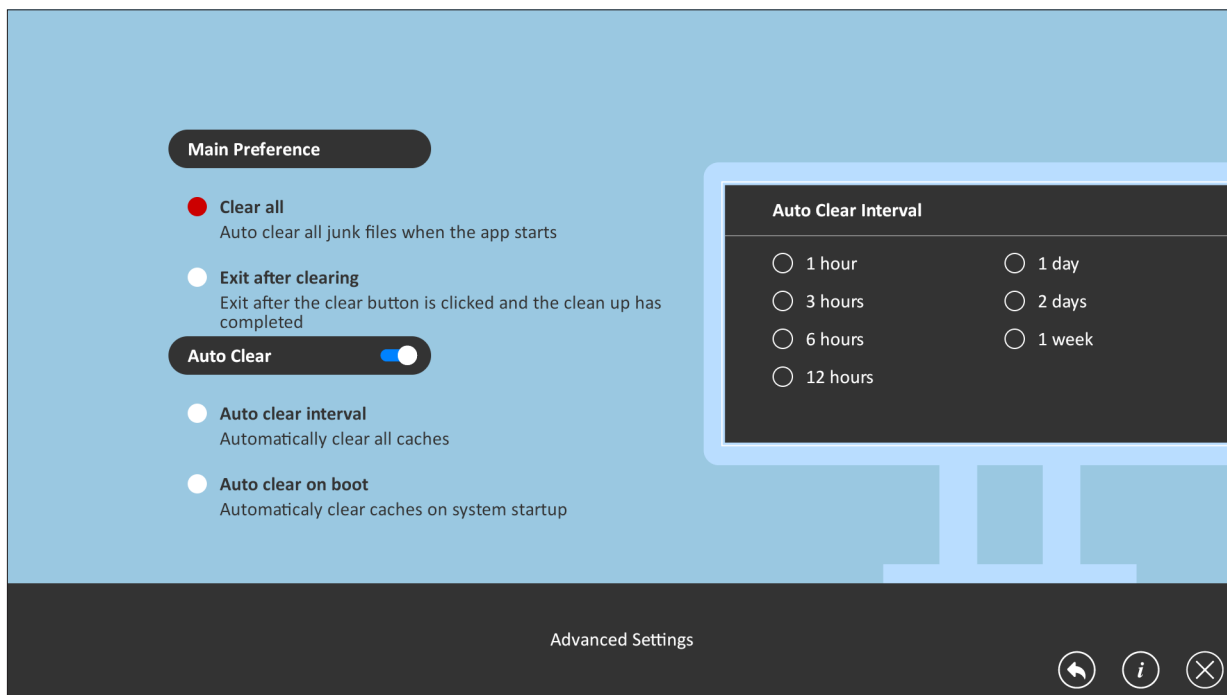

Folders

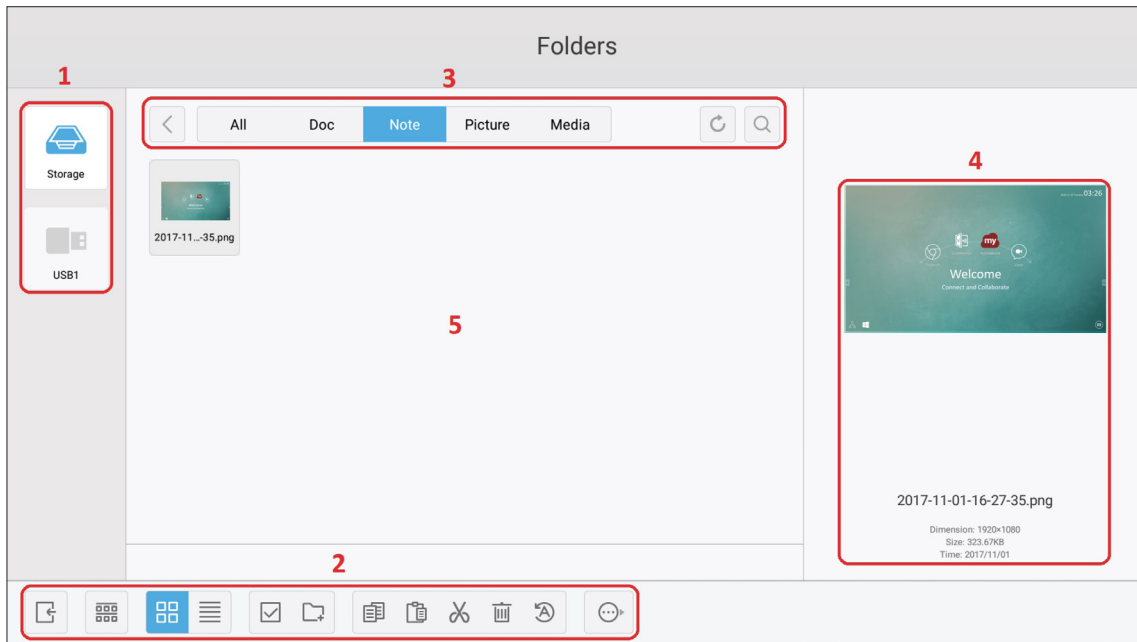

1. Storage Device Display

Select the appropriate storage device.

2. Icons

Item	Description
	Exit Exit Folders
	Sort Sort the files
	Thumbnail Display files by thumbnail view
	List Display files by list view
	Select Select a file
	Add folder Add a folder
	Copy Copy a file
	Paste Paste a file
	Cut Cut a file
	Delete Delete a file
	Rename Rename a file
	More Show more functions

3. File Type Menu

Item	Description
All	All types
Doc	Office files
Note	Images stored by myViewBoard, Side Tool Bar, and remote control Screen Capture button.
Picture	Image files
Media	Audio and Video files

4. File Information

Preview the file, show the file's name, size, resolution, and creation date.

5. Main Display Area

Display files of corresponding type.

RS-232 Protocol

This document describes the hardware interface spec and software protocols of the RS-232 interface communication between ViewSonic LFD and a PC or other control units with RS-232 protocol.

The protocol contains three command sections:

- Set-Function
- Get-Function
- Remote control pass-through mode

NOTE: Below, “PC” represents all the control units that can send or receive the RS-232 protocol command.

Description

RS-232 Hardware Specification

ViewSonic LFD communication port on the rear side:

1. Connector type: DSUB 9-Pin Male (female or 3.5 mm barrel connector)
2. Use of crossover (null modem) cable for connection
3. Pin Assignment:

Male DSUB 9-Pin
(preferred)

1 2 3 4 5



6 7 8 9

Female DSUB 9-Pin

5 4 3 2 1



9 8 7 6

3.5 mm barrel
connector (alternative
for limited space)



Pin #	Signal	Remark
1	NC	
2	RXD	Input to Display
3	TXD	Output from Display
4	NC	
5	GND	
6	NC	
7	NC	
8	NC	
9	NC	
frame	GND	

Item	Signal	Remark
Tip	TXD	Output from Display
Ring	RXD	Input to Display
Sleeve	GND	

LAN Hardware Specification

ViewSonic LFD communication port on the rear side:

1. Connector type: 8P8C RJ45
2. Pin Assignment:

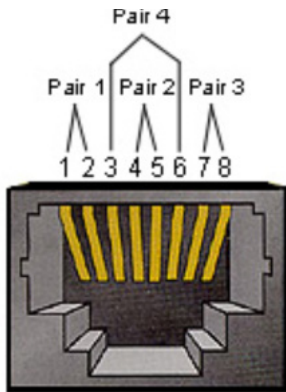

Pin #	Signal	Remark
1	TX+	Output from Display
2	TX-	Output from Display
3	RX+	Input to Display
4	BI_D3+	For 1G case
5	BI_D3-	For 1G case
6	RX-	Input to Display
7	BI_D4+	For 1G case
8	BI_D4-	For 1G case
frame	GND	

RS-232 Communication Setting

- Baud Rate Select: 9600bps (fixed)
- Data bits: 8 bits (fixed)
- Parity: None (fixed)
- Stop Bits: 1(fixed)

LAN Communication Setting

- Type: Ethernet
- Protocol: TCP/IP
- Port: 5000 (fixed)
- WOL Port: 9 (fixed) for UDP ^{*3.2.0}
- Cross subnet: No
- Logon Credentials: No

Command Message Reference

PC sends to LFD command packet followed by “CR”. Every time PC sends control command to Display, the Display shall respond as follows:

1. If the message is received correctly it will send “+” (02Bh) followed by “CR” (00Dh)
2. If the message is received incorrectly it will send “-” (02Dh) followed by “CR” (00Dh)

Protocol

Set-Function Listing

The PC can control the Display for specific actions. The Set-Function command allows you to control the Display behavior at a remote site through the RS-232 port. The Set-Function packet format consists of 9 bytes.

Set-Function Description:

- Length:** Total Byte of Message excluding "CR"
- LFD ID** Identification for each of Display (01~98; default is 01)
ID "99" means to apply the set command for all connected displays. Under such circumstances, only ID#1 display has to reply.
The LFD ID can be set via the OSD menu for each Display.
- Command Type** Identify command type,
"s" (0x73h): Set Command
"+" (0x2Bh): Valid command Reply
"- " (0x2Dh): Invalid command Reply
- Command:** Function command code: One byte ASCII code.
- Value[1~3]:** Three bytes ASCII that defines the value.
- CR** 0x0D

Set-Function Format

Send: (Command Type="s")

Name	Length	ID	Command Type	Command	Value1	Value2	Value3	CR
Byte Count	1 Byte	2 Byte	1 Byte	1 Byte	1 Byte	1 Byte	1 Byte	1 Byte
Bytes order	1	2~3	4	5	6	7	8	9

Reply: (Command Type="+" or "-")

Name	Length	ID	Command Type	CR
Byte Count	1 Byte	2 Byte	1 Byte	1 Byte
Bytes order	1	2~3	4	5

NOTE: When PC applies command to all displays (ID=99), only the #1 set needs to reply by the name of ID=1.

Example 1: Set Brightness as 76 for Display (#02) and this command is valid

Send (Hex Format)

Name	Length	ID	Command Type	Command	Value1	Value2	Value3	CR
Hex	0x38	0x30 0x32	0x73	0x24	0x30	0x37	0x36	0x0D

Reply (Hex Format)

Name	Length	ID	Command Type	CR
Hex	0x34	0x30 0x32	0x2B	0x0D

Example 2: Set Brightness as 75 for Display (#02) and this command is NOT valid

Send (Hex Format)

Name	Length	ID	Command Type	Command	Value1	Value2	Value3	CR
Hex	0x38	0x30 0x32	0x73	0x24	0x30	0x37	0x35	0x0D

Reply (Hex Format)

Name	Length	ID	Command Type	CR
Hex	0x34	0x30 0x32	0x2D	0x0D

Set-Function Table

A. Basic Function

Set Function	Length	ID	Command		Value Range	Comments	
			Type (ASCII)	Code (ASCII) Code (Hex)			
Power on *3.2.1/ off (standby)	8		s	!	21	000: STBY 001: ON	1. The Power-on via LAN control may work only under specific mode. To see display UG for details. *3.1.1 2. "WOL by MAC address" may available as alternative.*3.2.1
Input Select	8		s	"	22	004: HDMI1 014: HDMI2 024: HDMI 006: VGA 007: Slot-in PC (OPS) 009: DP 019: Type-C *3.2.4 00A: Embedded/ Main (Android)	1. No need for USB 2. For the case of two more same sources, the 2nd digital is used to indicate the extension. 3. The HEX of 00A is 30 30 41.
Brightness	8		s	\$	24	000 ~ 100 900: Bright down (-1) 901: Bright up (+1) *3.1.1	
Backlight *3.2.0	8		A	B	42	000 ~ 100	1. For Android platform whose main mode is controlled by backlight and the other sources are controlled by brightness. 2. Derived from Color calibration. *3.2.0
Power lock	8		s	4	34	000: Unlock 001: Lock	*See note in details
Volume	8		s	5	35	000 ~ 100 900: Volume down(-1) 901:Volume up(+1)	
Mute	8		s	6	36	000: OFF 001: ON (mute)	
Button lock	8		s	8	38	000: Unlock 001: Lock	*See note in details
Menu lock	8		s	>	3E	000: Unlock 001: Lock	*See note in details

Set Function	Length	ID	Command	Command	Value Range	Comments	
Number *3.1.1	8		s	@	40	000~009	
Key Pad *3.1.1	8		s	A	41	000: UP 001: DOWN 002: LEFT 003: RIGHT 004: ENTER 005: INPUT 006: MENU/(EXIT) 007: EXIT	
Remote Control	8		s	B	42	000: Disable 001: Enable 002: Pass through	Disable: RCU will be no function Enabled: RCU controls normally Pass through: Display will bypass the RC code to connected device via the RS-232 port, but not react itself.
Restore default	8		s	~	7E	000	Recover to factory setting

B. Optional Function

Set Function	Length	ID	Command		Value Range (Three ASCII bytes)	Comments
			Type (ASCII)	Code (ASCII) Code (Hex)		
Contrast	8		s	# 23	000 ~ 100	
Sharpness	8		s	% 25	000 ~ 100	
Color	8		s	& 26	000 ~ 100	
Tint	8		s	' 27	000 ~ 100	
Backlight On_Off *3.2.3	8		s	(29	000: Off 001: On	
Color mode	8		s) 29	000: Normal 001: Warm 002: Cold 003: Personal	
Freeze On_Off *3.2.5	8		s	* 2A	000: Off 001: On	
Bass	8		s	. 2E	000 ~ 100	
Treble	8		s	/ 2F	000 ~ 100	
Balance	8		s	0 30	000 ~ 100	050 is central
Picture Size	8		s	1 31	000: FULL (16:9) 001: NORMAL (4:3) 002: REAL (1:1) *3.1.0	
OSD language	8		s	2 32	000: English 001: French 002: Spanish	Could be extended for more supported languages by model
Date: Year	8		s	V 56	Y17~Y99	Last 2 digits (20)17~(20)99
Date: Month	8		s	V 56	M01~M12	2 digits
Date: Day	8		s	V 56	D01~D31	2 digits
Time: Hour	8		s	W 57	H00~H23	24-hr format. 2 digits.
Time: Min	8		s	W 57	M00~M59	2 digits
Time: Sec	8		s	W 57	S00~S59	2 digits
Customized Hot Keys *3.2.6	8		s	X 58	001~999 001: Open MVBA app *3.2.6	

Appendix

Specifications

Item	Category	Specifications					
		CDE4330	CDE5530	CDE6530	CDE7530	CDE8630	CED9830
Model	P/N.	CDE4330	CDE5530	CDE6530	CDE7530	CDE8630	CDE9830
	No.	VS19112	VS19113	VS19114	VS19115	VS19116	VS19117
Screen Size		43"	55"	65"	75"	86"	98"
Input Signal		2 x HDMI (v. 2.1, HDCP 2.2) 1 x USB Type C 1 x RS-232 1 x USB Type A (2.0) 1 x USB Type A (3.0) 1 x RJ45		3 x HDMI (v. 2.1, HDCP 2.2) 1 x USB Type C 1 x RS-232 1 x USB Type A (2.0) 1 x USB Type A (3.0) 1 x RJ45			
USB-C	Power Delivery Supported	Yes					
	Maximum Power Delivery (W)	65W					
OPS Slot		18V/3.5A					
Speaker Output		2 x 10W					
RS-232		RS-232 Communcation					
Power	Voltage	100~240V +/- 10% 50/60Hz	100~240V +/- 10% 50/60Hz	100~240V +/- 10% 50/60Hz	100~240V +/- 10% 50/60Hz	100~240V +/- 10% 50/60Hz	100~240V +/- 10% 50/60Hz
Operating Conditions	Temperature	0° C ~ 40° C					
	Humidity	10% ~ 90% RH					
	Altitude	3,000 m					
Storage Conditions	Temperature	-20° C ~ 60° C					
	Humidity	10% ~ 90% RH					
	Altitude	3,658 m					

Item	Category	Specifications					
		CDE4330	CDE5530	CDE6530	CDE7530	CDE8630	CED9830
Dimensions	Physical (W x H x D) mm (w/o stand)	964.6 x 552.5 x 71.4	1233 x 703.5 x 71.5	1463.3 x 838.3 x 81.6	1685.6 x 963.7 x 81.6	1930.8 x 1101.8 x 81.6	2212.9 x 1268.4 x 79
	Physical (W x H x D) in (w/o stand)	37.98" x 21.75" x 2.81"	48.54" x 27.70" x 2.81"	57.61" x 33.0" x 3.21"	66.36" x 37.94" x 3.21"	76.02" x 43.38" x 3.21"	87.12" x 49.94" x 3.11"
	Physical (W x H x D) mm (w/ stand)	1056 x 672 x 156	1332 x 819 x 156	1620 x 942 x 208	1863 x 1090 x 225	2110 x 1227 x 225	2360 x 1425 x 280
	Physical (W x H x D) in (w/ stand)	41.57" x 26.46" x 6.14"	52.44" x 32.24" x 6.14"	63.78" x 37.09" x 8.19"	73.35" x 42.91" x 8.86"	83.07" x 48.3" x 8.86"	92.91" x 56.1" x 11.02"
Weight	Physical (kg) (w/o stand)	9.9	13.4	25.4	34.65	43.15	69.4
	Physical (lbs) (w/o stand)	21.83	29.54	56	76.39	95.13	153
	Physical (kg) (w/ stand)	13.85	19.5	33.25	48.15	60.75	90.3
	Physical (lbs) (w/ stand)	30.53	42.99	73.3	106.15	133.93	199.1
Power Consumption	On (Typical)	115W	155W	165W	235W	340W	318W
	Off	< 0.5W					

NOTE: Product specifications are subject to change without notice.

USB Media Support Format

Photo

Image	Photo	Resolution
JPEG	Base-line	1920 x 1080
	Progressive	1024 x 768
PNG	non-interlace	1920 x 1080
	Interlace	1920 x 1080
BMP		15360 x 8640

Video

Container	Codec	Resolution	Bit Rate
MKV(.mkv) WebM(.webm)	VP9	4096 x 2176 @60fps	100Mbps
MP4(.mp4, .mov) 3GPP(.3gpp, .3gp) MEPG transport stream (.ts, .trp, .tp) MKV(.mkv) WebM(.webm) FLV(.flv) AVI(lavi) H265(.265)	HEVC/H.265	4096 x2176 @60fps	100Mbps
MP4(.mp4, .mov) 3GPP(.3gpp, .3gp) MEPG transport stream (.ts, .trp, .tp) MPEG program stream (.DAT, .VOB, .MPG, .MPEG) MKV(.mkv) WebM(.webm) AVI(lavi) ASF(.asf) WMV(.wmv) OGM(.ogm)	MPEG1/2	1920 x 1080 @120fps	40Mbps

Container	Codec	Resolution	Bit Rate
MP4(.mp4, .mov) 3GPP(.3gpp, .3gp) MEPG transport stream (.ts, .trp, .tp) MPEG program stream (.DAT, .VOB, .MPG, .MPEG) MKV(.mkv) WebM(.webm) FLV(.flv) AVI(lavi) ASF(.asf) WMV(.wmv) OGM(.ogm)	MPEG4	1920 x 1080 @120fps	40Mbps
ASF(.asf) AVI(.avi) DivX(.divx) MKV(.mkv) MP4(.mp4, .mov) OGM(.ogm) WebM(.webm) WMV(.wmv)	DivX 3.11 Divx 4.12 DivX 5.x DivX 6, XviD	1920 x 1080 @120fps	40Mbps
AVI(.avi) FLV(.flv)	Sorenson H.263	1920 x 1080 @120fps	40Mbps
3GPP(.3gpp, .3gp) ASF(.asf) AVI(lavi) FLV(.flv) MP4(.mp4, mov) WMV(.wmv)	H.263	1920 x 1080 @120fps	40Mbps

Container	Codec	Resolution	Bit Rate
3GPP(.3gpp, .3gp) ASF(.asf) AVI(.avi) FLV(.flv) H.264(.264) MKV(.mkv) MP4(.mp4, .mov) MEPG transport stream (.ts, .trp, .tp) MPEG program stream (.DAT, .VOB, .MPG, .MPEG) OGM(.ogm) WebM(.webm) WMV(.wmv)	H.264	4096 x 2160 @60fps	135Mbps
AVS(.avs) MEPG transport stream (.ts, .trp, .tp)	AVS	1920 x 1080 @60fps	50Mbps
AVS(.avs) MEPG transport stream (.ts, .trp, .tp)	AVS+	1920 x 1080 @60fps	50Mbps
AVS(.avs2) MEPG transport stream (.ts, .trp, .tp)	AVS2	4096 x 2160 @60fps	100Mbps
3GPP(.3gpp, .3gp) ASF(.asf) AVI(.avi) MKV(.mkv) MP4(.mp4, .mov) OGM(.ogm) WebM(.webm) WMV(.wmv)	WMV3	1920 x 1080 @120fps	40Mbps

Container	Codec	Resolution	Bit Rate
3GPP(.3gpp, .3gp) ASF(.asf) AVI(.avi) MKV(.mkv) MP4(.mp4, .mov) MEPG transport stream (.ts, .trp, .tp) WebM(.webm) WMV(.wmv) VC1(.vc1)	VC1	2048 x 1024 @120fps	40Mbps
3GPP(.3gpp, 3gp) AVI(.avi) FLV(.flv) MKV(.mkv) MP4(.mp4, .mov) OGM(.gom) WebM(.webm)	Motion JPEG	1920 x 1080 @30fps	40Mbps
3GPP(.3gpp, .3gp) AVI(.avi) FLV(.flv) MKV(.mkv) MP4(.mp4, .mov) OGM(.gom) WebM(.webm)	VP8	1920 x 1080 @60fps	50Mbps
MKV(.mkv) RM(.rm, .rmvb) WebM(.webm)	RV30/RV40	1920 x 1080 @60fps	40Mbps
3GPP(.3gpp, .3gp) MKV(.mkv) MP4(.mp4, .mov) WebM(.webm)	AV1	4096 x 2176 @60fps	100Mbps

Audio

Container	Codec	Sample Rate	Channel	Bit Rate
3GPP(.3gpp, .3gp) ASF(.asf) AVI(.avi) DivX(.divx) FLV(.flv) MKV(.mkv, .mka) MP3(.mp3) MP4(.mp4) MEPG transport stream (.ts, .trp, .tp) MPEG program stream(.DAT, .VOB, .MPG, .MPEG) OGM(.ogm) WAV(.wav) WebM(.webm) WMV(.wmv)	MPEG1/2 Layer1	16KHz ~ 48KHz	Up to 2	32Kbps ~ 448Kbps
	MPEG1/2 Layer2	16KHz ~ 48KHz	Up to 2	8Kbps ~ 384Kbps
	MPEG1/2/2.5 Layer3	8KHz ~ 48KHz	Up to 2	8Kbps ~ 320Kbps
3GPP(.3gpp, .3gp) ASF(.asf) AVI(.avi) AC3(.ac3) DivX(.divx) MKV(.mkv, .mka) MP4(.mp4) MEPG transport stream (.ts, .trp, .tp) MPEG program stream (.DAT, .VOB, .MPG, .MPEG) OGM(.ogm) WebM(.webm) WMV(.wmv)	AC3(DD)	32KHz, 44.1KHz, 48KHz	Up to 5.1	32Kbps ~ 640Kbps

Container	Codec	Sample Rate	Channel	Bit Rate
3GPP(.3gpp, .3gp) ASF(.asf) AVI(.avi) DivX(.divx) EAC3(.ec3) MKV(.mkv, .mka) MP4(.mp4) MEPG transport stream (.ts, .trp, .tp) MPEG program stream (.DAT, .VOB, .MPG, .MPEG)	EAC3(DDP)	32KHz, 44.1KHz, 48KHz	Up to 5.1	32Kbps ~ 6Mbps
OGM(.ogm) WebM(.webm) WMV(.wmv)	EAC3(DDP)	32KHz, 44.1KHz, 48KHz	Up to 5.1	32Kbps ~ 6Mbps
3GPP(.3gpp, .3gp) AAC(.aac) ASF(.asf) AVI(.avi) DivX(.divx) FLV(.flv) MKV(.mkv, .mka) MP4(.mp4) MEPG transport stream (.ts, .trp, .tp) MPEG program steam (.DAT, .VOB, .MPG, .MPEG) OGM(.ogm) RM(.rm, .rmvb, .ra) WAV(.wav) WebM(.webm) WMV(.wmv)	AAC-LC, HEAAC	8KHz ~ 48KHz	Up to 5.1	AAC-LC: 12kbps ~576kbps V1: 6kbps ~ 288kbps V2: 3kbps ~ 144kbps

Container	Codec	Sample Rate	Channel	Bit Rate
3GPP(.3gpp, .3gp) ASF(.asf) AVI(.avi) MKV(.mkv, .mka) MP4(.mp4, .mov) WebM(.webm) WMV(.wma, .wmv)	WMA	8KHz ~ 48KHz	Up to 2	128Kbps ~ 320kbps
3GPP(.3gpp, .3gp) ASF(.asf) AVI(.avi) MP4(.mp4, .mov) WMV(.wma, .wmv)	WMA 10 Pro M0	8KHz ~ 48KHz	Up to 2	< 192kbps
	WMA 10 Pro M1	8KHz ~ 48KHz	Up to 5.1	< 384kbps
	WMA 10 Pro M2	8KHz ~ 96KHz	Up to 5.1	< 768kbps
3GPP(.3gpp, .3gp) ASF(.asf) AVI(.avi) MKV(.mkv, .mka) MP4(.mp4, .mov) Ogg(.ogg) WebM(.webm) WMV(.wma, .wmv)	VORBIS *Support stereo decoding only	Up to 48KHz	Up to 2	

Container	Codec	Sample Rate	Channel	Bit Rate
3GPP(.3gpp, .3gp) AVI(.avi) DTS(.dts) MKV(.mkv, .mka) MP4(.mp4, .mov) MEPG transport stream (.ts, .trp, .tp) MPEG program stream (.DAT, .VOB, .MPG, .MPEG) OGM(.ogm) WAV(.wav) WebM(.webm)	DTS	Up to 48KHz	Up to 5.1	< 1.5Mbps (Pure DTS core)
3GPP(.3gpp, .3gp) MP4(.mp4, .mov) MEPG transport stream (.ts, .trp, .tp)	DTS LBR	12KHz,22KHz, 24KHz, 44.1KHz, 48KHz	Up to 5.1	Up to 2Mbps
3GPP(.3gpp, .3gp) MP4(.mp4, .mov) MEPG transport stream (.ts, .trp, .tp, .mts, .m2ts)	DTS XLL	Up to 96KHz	Up to 6	Up to 6.123Mbps
3GPP(.3gpp, .3gp) MP4(.mp4, .mov) MEPG transport stream (.ts, .trp, .tp, .mts, .m2ts)	DTS Master Audio	Up to 48KHz	Up to 6	Up to 24.537Mbps

Container	Codec	Sample Rate	Channel	Bit Rate
3GPP(.3gpp, .3gp) ASF(.asf) AVI(.avi) FLV(.flv) MKV(.mkv, .mka) MP4(.mp4, .mov, .m4a) MEPG transport stream (.ts, .trp, .tp) MPEG program stream (.DAT, .VOB, .MPG, .MPEG) OGM(.ogm) WAV(.wav) WebM(.webm) WMV(.wmv)	LPCM	8Khz ~ 48Khz	Mono, Stereo 5.1	64Kbps ~ 1.5Mbps
AVI(.avi) MKV(.mkv, .mka) OGM(.ogm) WAV(.wav) WebM(.webm)	IMA-ADPCM MS)ADPCM	8KHz ~ 48KHz	Up to 2	32kbps ~ 384kbps
AVI(.avi) FLV(.flv) MKV(.mkv, .mka) WAV(.wav) WebM(.webm)	G711 A /mu-law	8KHz	1	64Kbps
RM(.rm, .rmvb, .ra)	LBR(cook)	8KHz, 11.025KHz, 22.05KHz, 44.1KHz	Up to 5.1	6Kbps ~ 128Kbps
FLAC(.flac) MKV(.mkv, .mka) WebM(.webm)	FLAC	8KHz ~ 96KHz	Up to 7.1	< 1.6Mbps
MKV(.mkv, .mka) WebM(.webm)	OPUS	8KHz ~ 48KHz	Up to 6	6Kbps ~ 510Kbps

Container	Codec	Sample Rate	Channel	Bit Rate
3GPP(.3gpp, .3gp) AC4(.ac4) MP4(.mp4, .mov, .m4a) MEPG transport stream (.ts, .trp, .tp)	AC4	44.1KHz, 48KHz	Up to 5.1 (MS12 v1.x) Up to 7.1 (MS12 v2.x)	Up to 1521kbps per presentation
3GPP(.3gpp, .3gp) MP4(.mp4, .mov, .m4a)	Fraunhofer MPEG-H TV Audio System	32KHz, 44.1KHz, 48KHz	Up to 16 core channels Up to 5.1 channels output	~1.2Mbps
3GPP(.3gpp, .3gp) MP4(.mp4, .mov, .m4a)	AMR-NB	8kHz	1	4.75 ~ 12.2Kbps
3GPP(.3gpp, .3gp) MP4(.mp4, .mov, .m4a)	AMR-WB	16KHz	1	6.6 ~ 23.85Kbps

Subtitle

Internal

File Extension	Container	Codec
dat, mpg, mpeg, vob	MPG, MPEG	DVD Subtitle
ts, trp, tp	TS	DVB Subtitle
mp4	MP4	DVD Subtitle UTF-8 Plain Text
mkv	MKV	ASS SSA UTF-8 Plain Text VobSub DVD Subtitle
divx, avi	AVI(1.0, 2.0) DMF0, 1, 2	XSUB XSUB+

External

File Extension	Container	Codec
.srt	SubRip	
.ssa/.ass	SubStation Alpha	
.smi	SAMI	
.sub	SubViewer MicroDVD DVDSubtitleSystem SubIdx(VobSub)	SubViewer 1.0 & 2.0 Only
.txt	TMPlayer	

Timing Table

HDMI PC

Resolution	Refresh Rate
640 x 480	60Hz
	72Hz
800 x 600	75Hz
	72Hz
	75Hz
1024 x 768	60Hz
	70Hz
	75Hz
1280 x 1024	60Hz
1360 x 768	60Hz
1920 x 1080	60Hz

HDMI

Video	Resolution	Refresh Rate
480i	720 x 480	60Hz
480p	720 x 480	60Hz
576i	720 x 576	50Hz
576p	720 x 576	50Hz
720p	1280 x 720	50Hz
		60Hz
1080i	1920 x 1080	50Hz
		60Hz
1080p	1920 x 1080	50Hz
		60Hz

Video	Resolution	Refresh Rate
4K	3840 x 2160	29.97Hz/R444
	3840 x 2160	30Hz/R444
	3840 x 2160	25Hz/R444
	3840 x 2160	23.98Hz/R444
	3840 x 2160	24Hz/R444
	4096 x 2160	24Hz/R444
	3840 x 2160	50Hz/R444
	3840 x 2160	59Hz/R444
	3840 x 2160	60Hz/R444
	4096 x 2160	50Hz/R444
	4096 x 2160	59Hz/R444
	4096 x 2160	60Hz/R444

Type-C

Video	Resolution	Refresh Rate
480p (4:3)	640 x 480	60Hz
	640 x 480	60Hz
	720 x 480	60Hz
	1440 x 480	60Hz
480p (16:9)	720 x 480	60Hz
	1440 x 480	60Hz
	1440 x 480	60Hz
576p (4:3)	720 x 576	50Hz
576p (16:9)	720 x 576	50Hz
	1440 x 576	50Hz
720p (16:9)	1280 x 720	50Hz
	1280 x 720	60Hz
	1280 x 720	60Hz

Video	Resolution	Refresh Rate
1080p (16:9)	1920 x 1080	24Hz
	1920 x 1080	24Hz
	1920 x 1080	25Hz
	1920 x 1080	30Hz
	1920 x 1080	30Hz
	1920 x 1080	50Hz
	1920 x 1080	60Hz
	1920 x 1080	60Hz
4K	3840 x 2160	24Hz
	3840 x 2160	25Hz
	3840 x 2160	30Hz
	3840 x 2160	50Hz
	3840 x 2160	60Hz

Troubleshooting

This section describes some common problems that you may experience when using the display.

Problem or Issue	Possible Solutions
Remote Control is not working	<ol style="list-style-type: none">1. Check whether something is obstructing the display's remote control receiver.2. Check whether the batteries in the remote control are installed correctly.3. Check whether the batteries need to be replaced.
The unit turns off unexpectedly	<ol style="list-style-type: none">1. Check whether Sleep mode is enabled.2. Check if there is a power outage in your area.3. Turn on the display and see if the problem is with the signal and control system.

PC Mode

Problem or Issue	Possible Solutions
No PC signal	<ol style="list-style-type: none">1. Check the display settings.2. Check the display resolution.3. Adjust the Hs & Vs (synchronization) settings using the OSD menu.
Background streaking	<ol style="list-style-type: none">1. Choose auto adjust.2. Adjust clock and phase.
False color	<ol style="list-style-type: none">1. Check the connection.2. Adjust the chroma, brightness, and contrast settings.
Unsupported format	<ol style="list-style-type: none">1. Choose auto adjust.2. Adjust clock and phase settings.

Video Not Working Properly

Problem or Issue	Possible Solutions
No picture/ No sound	<ol style="list-style-type: none">1. Check the Power status.2. Check the signal cable.3. Check that the internal PC is installed correctly.
Picture is unclear or cuts in and out	<ol style="list-style-type: none">1. Check the signal cable.2. Check if other electronics are interrupting the signal.
Poor picture	<ol style="list-style-type: none">1. Adjust chroma, brightness, and contrast settings in the menu.2. Check the signal cable.

Audio Not Working Properly

Problem or Issue	Possible Solutions
No sound	<ol style="list-style-type: none">1. Press the Mute/Unmute button.2. Adjust the volume.3. Check the audio cable.
One speaker only	<ol style="list-style-type: none">1. Adjust the sound balance in the menu.2. Check the sound control panel settings of the computer.3. Check the audio cable.

Maintenance

General Precautions

- Make sure the device is turned off and the power cable is unplugged from the power outlet.
- Never spray or pour any liquid directly onto the screen or case.
- Handle the device with care, as a darker-colored device, if scuffed, may show marks more clearly than a lighter-colored device.
- Do not use the system continuously for long periods of time.

Cleaning the Screen

- Wipe the screen with a clean, soft, lint-free cloth. This removes dust and other particles.
- If the screen is still not clean, apply a small amount of non-ammonia, non-alcohol based glass cleaner onto a clean, soft, lint-free cloth; then wipe the screen.

Cleaning the Case

- Use a soft, dry cloth.
- If the case is still not clean, apply a small amount of non-ammonia, non-alcohol based, mild non-abrasive detergent onto a clean, soft, lint-free cloth, then wipe the surface.

Disclaimer

- ViewSonic® does not recommend the use of any ammonia or alcohol-based cleaners on the display screen or case. Some chemical cleaners have been reported to damage the screen and/or case of the device.
- ViewSonic® will not be liable for damage resulting from use of any ammonia or alcohol-based cleaners.

NOTE: If condensation appears between the glass and the panel, keep the display turned on until the moisture disappears.

Regulatory and Service Information

Compliance Information

This section addresses all connected requirements and statements regarding regulations. Confirmed corresponding applications shall refer to nameplate labels and relevant markings on the unit.

FCC Compliance Statement

This device complies with part 15 of FCC Rules. Operation is subject to the following two conditions: (1) this device may not cause harmful interference, and (2) this device must accept any interference received, including interference that may cause undesired operation.

This equipment has been tested and found to comply with the limits for a Class B digital device, pursuant to part 15 of the FCC Rules. These limits are designed to provide reasonable protection against harmful interference in a residential installation. This equipment generates, uses, and can radiate radio frequency energy, and if not installed and used in accordance with the instructions, may cause harmful interference to radio communications. However, there is no guarantee that interference will not occur in a particular installation. If this equipment does cause harmful interference to radio or television reception, which can be determined by turning the equipment off and on, the user is encouraged to try to correct the interference by one or more of the following measures:

- Reorient or relocate the receiving antenna.
- Increase the separation between the equipment and receiver.
- Connect the equipment into an outlet on a circuit different from that to which the receiver is connected.
- Consult the dealer or an experienced radio/TV technician for help.

Warning: You are cautioned that changes or modifications not expressly approved by the party responsible for compliance could void your authority to operate the equipment.

Industry Canada Statement

CAN ICES-003(B) / NMB-003(B)

CE Conformity for European Countries

CE The device complies with the EMC Directive 2014/30/EU and Low Voltage Directive 2014/35/EU.

The following information is only for EU-member states:

The mark shown to the right is in compliance with the Waste Electrical and Electronic Equipment Directive 2012/19/EU (WEEE). The mark indicates the requirement NOT to dispose of the equipment as unsorted municipal waste, but use the return and collection systems according to local law.



Declaration of RoHS2 Compliance

This product has been designed and manufactured in compliance with Directive 2011/65/EU of the European Parliament and the Council on restriction of the use of certain hazardous substances in electrical and electronic equipment (RoHS2 Directive) and is deemed to comply with the maximum concentration values issued by the European Technical Adaptation Committee (TAC) as shown below:

Substance	Proposed Maximum Concentration	Actual Concentration
Lead (Pb)	0.1%	< 0.1%
Mercury (Hg)	0.1%	< 0.1%
Cadmium (Cd)	0.01%	< 0.01%
Hexavalent Chromium (Cr6 ⁺)	0.1%	< 0.1%
Polybrominated biphenyls (PBB)	0.1%	< 0.1%
Polybrominated diphenyl ethers (PBDE)	0.1%	< 0.1%
Bis (2-ethylhexyl) phthalate (DEHP)	0.1%	< 0.1%
Butyl benzyl phthalate (BBP)	0.1%	< 0.1%
Dibutyl phthalate (DBP)	0.1%	< 0.1%
Diisobutyl phthalate (DIBP)	0.1%	< 0.1%

Certain components of products as stated above are exempted under the Annex III of the RoHS2 Directives as noted below. Examples of exempted components are:

- Copper alloy containing up to 4% lead by weight.
- Lead in high melting temperature type solders (i.e. lead-based alloys containing 85% by weight or more lead).
- Electrical and electronic components containing lead in a glass or ceramic other than dielectric ceramic in capacitors, e.g. piezoelectronic devices, or in a glass or ceramic matrix compound.
- Lead in dielectric ceramic in capacitors for a rated voltage of 125V AC or 250V DC or higher.

ENERGY STAR Statement

ENERGY STAR is a U.S. Environmental Protection Agency voluntary program that helps businesses and individuals save money and protect our climate through superior energy efficiency. Products that earn the ENERGY STAR prevent greenhouse gas emissions by meeting strict energy efficiency criteria or requirements set by the U.S. Environmental Protection Agency.

As an ENERGY STAR Partner, ViewSonic is determined to meet the Energy star Guidelines and mark all certified models with the ENERGY STAR logo.

The following logo appears on all ENERGY STAR-certified models:



NOTE: The power management features significantly reduce energy consumption when the product is not in use. Power management allows the device to automatically enter a low power “sleep” mode after a defined period of inactivity. And the power management features also enter Sleep Mode or Off Mode within 5 minutes of being disconnected from a host computer. Please note any change in energy settings will increase energy consumption.

Indian Restriction of Hazardous Substances

Restriction on Hazardous Substances statement (India). This product complies with the “India E-waste Rule 2011” and prohibits use of lead, mercury, hexavalent chromium, polybrominated biphenyls or polybrominated diphenyl ethers in concentrations exceeding 0.1 weight % and 0.01 weight % for cadmium, except for the exemptions set in Schedule 2 of the Rule.

Product Disposal at End of Product Life

ViewSonic® respects the environment and is committed to working and living green. Thank you for being part of Smarter, Greener Computing. Please visit the ViewSonic® website to learn more.

USA & Canada:

<https://www.viewsonic.com/us/go-green-with-viewsonic>

Europe:

<https://www.viewsonic.com/eu/go-green-with-viewsonic>

Taiwan:

<https://recycle.epa.gov.tw/>

Copyright Information

Copyright© ViewSonic® Corporation, 2022. All rights reserved.

Macintosh and Power Macintosh are registered trademarks of Apple Inc.

Microsoft, Windows, and the Windows logo are registered trademarks of Microsoft Corporation in the United States and other countries.

ViewSonic®, the three birds logo, OnView, ViewMatch, and ViewMeter are registered trademarks of ViewSonic® Corporation.

VESA is a registered trademark of the Video Electronics Standards Association. DPMS, DisplayPort, and DDC are trademarks of VESA.

Disclaimer: ViewSonic® Corporation shall not be liable for technical or editorial errors or omissions contained herein; nor for incidental or consequential damages resulting from furnishing this material, or the performance or use of this product.

In the interest of continuing product improvement, ViewSonic® Corporation reserves the right to change product specifications without notice. Information in this document may change without notice.

No part of this document may be copied, reproduced, or transmitted by any means, for any purpose without prior written permission from ViewSonic® Corporation.

Customer Service

For technical support or product service, see the table below or contact your reseller.

NOTE: You will need the product's serial number.

Country/Region	Website	Country/Region	Website
Asia Pacific & Africa			
Australia	www.viewsonic.com/au/	Bangladesh	www.viewsonic.com/bd/
中国 (China)	www.viewsonic.com.cn	香港 (繁體中文)	www.viewsonic.com/hk/
Hong Kong (English)	www.viewsonic.com/hk-en/	India	www.viewsonic.com/in/
Indonesia	www.viewsonic.com/id/	Israel	www.viewsonic.com/il/
日本 (Japan)	www.viewsonic.com/jp/	Korea	www.viewsonic.com/kr/
Malaysia	www.viewsonic.com/my/	Middle East	www.viewsonic.com/me/
Myanmar	www.viewsonic.com/mm/	Nepal	www.viewsonic.com/np/
New Zealand	www.viewsonic.com/nz/	Pakistan	www.viewsonic.com/pk/
Philippines	www.viewsonic.com/ph/	Singapore	www.viewsonic.com/sg/
臺灣 (Taiwan)	www.viewsonic.com/tw/	ประเทศไทย	www.viewsonic.com/th/
Việt Nam	www.viewsonic.com/vn/	South Africa & Mauritius	www.viewsonic.com/za/
Americas			
United States	www.viewsonic.com/us	Canada	www.viewsonic.com/us
Latin America	www.viewsonic.com/la		
Europe			
Europe	www.viewsonic.com/eu/	France	www.viewsonic.com/fr/
Deutschland	www.viewsonic.com/de/	Қазақстан	www.viewsonic.com/kz/
Россия	www.viewsonic.com/ru/	España	www.viewsonic.com/es/
Türkiye	www.viewsonic.com/tr/	Україна	www.viewsonic.com/ua/
United Kingdom	www.viewsonic.com/uk/		

Limited Warranty

ViewSonic® Display

What the warranty covers:

ViewSonic® warrants its products to be free from defects in material and workmanship during the warranty period. If a product proves to be defective in material or workmanship during the warranty period, ViewSonic® will, at its sole option, and as your sole remedy, repair or replace the product with a similar product. Replacement Product or parts may include remanufactured or refurbished parts or components. The repair or replacement unit or parts or components will be covered by the balance of the time remaining on the customer's original limited warranty and the warranty period will not be extended. ViewSonic® provides no warranty for any third-party software whether included with the product or installed by the customer, installation of any unauthorized hardware parts or components (e.g. Projector Lamps). (Please refer to: "What the warranty excludes and does not cover" section).

How long the warranty is effective:

ViewSonic® displays are warranted for between 1 and 3 years, depending on your country of purchase, for all parts including the light source and for all labor from the date of the first consumer purchase.

Who the warranty protects:

This warranty is valid only for the first consumer purchaser.

What the warranty excludes and does not cover:

- Any product on which the serial number has been defaced, modified, or removed.
- Damage, deterioration, or malfunction resulting from:
 - » Accident, misuse, neglect, fire, water, lightning, or other acts of nature, unauthorized product modification, or failure to follow instructions supplied with the product.
 - » Repair or attempted repair by anyone not authorized by ViewSonic®.
 - » Damage to or loss of any programs, data, or removable storage media.
 - » Normal wear and tear.
 - » Removal or installation of the product.
- Software or data loss occurring during repair or replacement.

- Any damage of the product due to shipment.
- Causes external to the product, such as electric power fluctuations or failure.
- Use of supplies or parts not meeting ViewSonic's specifications.
- Failure of owner to perform periodic product maintenance as stated in the User Guide.
- Any other cause which does not relate to a product defect.
- Damage caused by static (non-moving) images displayed for lengthy periods of time (also referred to as image burn-in).
- Software - Any third-party software included with the product or installed by the customer.
- Hardware/Accessories/Parts/Components – Installation of any unauthorized hardware, accessories, consumable parts or components (e.g. Projector Lamps).
- Damage to, or abuse of, the coating on the surface of the display through inappropriate cleaning as described in the product User Guide.
- Removal, installation, and set-up service charges, including wall-mounting of the product.

How to get service:

- For information about receiving service under warranty, contact ViewSonic® Customer Support (Please refer to the "Customer Service" page). You will need to provide your product's serial number.
- To obtain warranty service, you will be required to provide: (a) the original dated sales slip, (b) your name, (c) your address, (d) a description of the problem, and (e) the serial number of the product.
- Take or ship the product, freight prepaid, in the original container to an authorized ViewSonic® service center or ViewSonic®.
- For additional information or the name of the nearest ViewSonic® service center, contact ViewSonic®.

Limitation of implied warranties:

There are no warranties, express or implied, which extend beyond the description contained herein including the implied warranty of merchantability and fitness for a particular purpose.

Exclusion of damages:

ViewSonic's liability is limited to the cost of repair or replacement of the product. ViewSonic® shall not be liable for:

- Damage to other property caused by any defects in the product, damages based upon inconvenience, loss of use of the product, loss of time, loss of profits, loss of business opportunity, loss of goodwill, interference with business relationships, or other commercial loss, even if advised of the possibility of such damages.
- Any other damages, whether incidental, consequential or otherwise.
- Any claim against the customer by any other party.
- Repair or attempted repair by anyone not authorized by ViewSonic®.

Effect of state law:

This warranty gives you specific legal rights, and you may also have other rights which vary from state to state. Some states do not allow limitations on implied warranties and/or do not allow the exclusion of incidental or consequential damages, so the above limitations and exclusions may not apply to you.

Sales outside the U.S.A. and Canada:

For warranty information and service on ViewSonic® products sold outside of the U.S.A. and Canada, contact ViewSonic® or your local ViewSonic® dealer.

The warranty period for this product in mainland China (Hong Kong, Macao, and Taiwan Excluded) is subject to the terms and conditions of the Maintenance Guarantee Card.

For users in Europe and Russia, full details of warranty provided can be found at: <http://www.viewsonic.com/eu/> under "Support/Warranty Information".

Mexico Limited Warranty

ViewSonic® Display

What the warranty covers:

ViewSonic® warrants its products to be free from defects in material and workmanship, under normal use, during the warranty period. If a product proves to be defective in material or workmanship during the warranty period, ViewSonic® will, at its sole option, repair or replace the product with a like product. Replacement product or parts may include remanufactured or refurbished parts or components & accessories.

How long the warranty is effective:

ViewSonic® LCD displays are warranted for between 1 and 3 years, depending on your country of purchase, for all parts including the light source and for all labour from the date of the first consumer purchase.

Who the warranty protects:

This warranty is valid only for the first consumer purchaser.

What the warranty excludes and does not cover:

- Any product on which the serial number has been defaced, modified or removed.
- Damage, deterioration, or malfunction resulting from:
 - » Accident, misuse, neglect, fire, water, lightning, or other acts of nature, unauthorized product modification, unauthorized attempted repair, or failure to follow instructions supplied with the product.
 - » Causes external to the product, such as electrical power fluctuations or failure.
 - » Use of supplies or parts not meeting ViewSonic®'s specifications.
 - » Normal wear and tear.
 - » Any other cause which does not relate to a product defect.
- Any product exhibiting a condition commonly known as "image burn-in" which results when a static image is displayed on the product for an extended period of time.
- Removal, installation, insurance, and set-up service charges.

How to get service:

For information about receiving service under warranty, contact ViewSonic® Customer Support (Please refer to the attached “Customer Service” page). You will need to provide your product’s serial number, so please record the product information in the space provided below on your purchase for your future use. Please retain your receipt of proof of purchase to support your warranty claim.

For Your Records

Product Name: _____ Model Number: _____

Document Number: _____ Serial Number: _____

Purchase Date: _____ Extended Warranty Purchase? _____ (Y/N)

If so, what date does warranty expire? _____

- To obtain warranty service, you will be required to provide (a) the original dated sales slip, (b) your name, (c) your address, (d) a description of the problem, and (e) the serial number of the product.
- Take or ship the product, in the original container packaging, to an authorized ViewSonic® service center.
- Round trip transportation costs for in-warranty products will be paid by ViewSonic®.

Limitation of implied warranties:

There are no warranties, express or implied, which extend beyond the description contained herein including the implied warranty of merchantability and fitness for a particular purpose.

Exclusion of damages:

ViewSonic®’s liability is limited to the cost of repair or replacement of the product. ViewSonic® shall not be liable for:

- Damage to other property caused by any defects in the product, damages based upon inconvenience, loss of use of the product, loss of time, loss of profits, loss of business opportunity, loss of goodwill, interference with business relationships, or other commercial loss, even if advised of the possibility of such damages.
- Any other damages, whether incidental, consequential or otherwise.
- Any claim against the customer by any other party.
- Repair or attempted repair by anyone not authorized by ViewSonic®.

Contact Information for Sales & Authorized Service (Centro Autorizado de Servicio) within Mexico:	
Name, address, of manufacturer and importers: México, Av. de la Palma #8 Piso 2 Despacho 203, Corporativo Interpalmas, Col. San Fernando Huixquilucan, Estado de México Tel: (55) 3605-1099 http://www.viewsonic.com/la/soporte/index.htm	
NÚMERO GRATIS DE ASISTENCIA TÉCNICA PARA TODO MÉXICO: 001.866.823.2004	
Hermosillo: Distribuciones y Servicios Computacionales SA de CV. Calle Juárez 284 local 2 Col. Bugambilias C.P: 83140 Tel: 01-66-22-14-9005 E-Mail: disc2@hmo.megared.net.mx	Villahermosa: Compumantenimientos Garantizados, S.A. de C.V. AV. GREGORIO MENDEZ #1504 COL, FLORIDA C.P. 86040 Tel: 01 (993) 3 52 00 47 / 3522074 / 3 52 20 09 E-Mail: compumantenimientos@prodigy.net.mx
Puebla, Pue. (Matriz): RENTA Y DATOS, S.A. DE C.V. Domicilio: 29 SUR 721 COL. LA PAZ 72160 PUEBLA, PUE. Tel: 01(52).222.891.55.77 CON 10 LINEAS E-Mail: datos@puebla.megared.net.mx	Veracruz, Ver.: CONEXION Y DESARROLLO, S.A DE C.V. Av. Americas # 419 ENTRE PINZÓN Y ALVARADO Fracc. Reforma C.P. 91919 Tel: 01-22-91-00-31-67 E-Mail: gacosta@qplus.com.mx
Chihuahua: Soluciones Globales en Computación C. Magisterio # 3321 Col. Magisterial Chihuahua, Chih. Tel: 4136954 E-Mail: Cefeo@soluglobales.com	Cuernavaca: Compusupport de Cuernavaca SA de CV Francisco Leyva # 178 Col. Miguel Hidalgo C.P. 62040, Cuernavaca Morelos Tel: 01 777 3180579 / 01 777 3124014 E-Mail: aquevedo@compusupportcva.com
Distrito Federal: QPLUS, S.A. de C.V. Av. Coyoacán 931 Col. Del Valle 03100, México, D.F. Tel: 01(52)55-50-00-27-35 E-Mail : gacosta@qplus.com.mx	Guadalajara, Jal.: SERVICRECE, S.A. de C.V. Av. Niños Héroes # 2281 Col. Arcos Sur, Sector Juárez 44170, Guadalajara, Jalisco Tel: 01(52)33-36-15-15-43 E-Mail: mmiranda@servicrece.com
Guerrero Acapulco: GS Computación (Grupo Sesicomp) Progreso #6-A, Colo Centro 39300 Acapulco, Guerrero Tel: 744-48-32627	Monterrey: Global Product Services Mar Caribe # 1987, Esquina con Golfo Pérsico Fracc. Bernardo Reyes, CP 64280 Monterrey N.L. México Tel: 8129-5103 E-Mail: aydeem@gps1.com.mx
MERIDA: ELECTROSER Av Reforma No. 403Gx39 y 41 Mérida, Yucatán, México CP97000 Tel: (52) 999-925-1916 E-Mail: rrrb@sureste.com	Oaxaca, Oax.: CENTRO DE DISTRIBUCION Y SERVICIO, S.A. de C.V. Murguía # 708 P.A., Col. Centro, 68000, Oaxaca Tel: 01(52)95-15-15-22-22 Fax: 01(52)95-15-13-67-00 E-Mail: gpotai2001@hotmail.com
Tijuana: STD Av Ferrocarril Sonora #3780 L-C Col 20 de Noviembre Tijuana, Mexico	FOR USA SUPPORT: ViewSonic® Corporation 381 Brea Canyon Road, Walnut, CA. 91789 USA Tel: 800-688-6688 E-Mail: http://www.viewsonic.com



ViewSonic®