

EPSON

DS-C490

User's Guide

Product Features

Scanner Basics

Placing Originals

Scanning

Maintenance

Solving Problems

Contents

About This Manual

Introduction to the Manuals.	5
Marks and Symbols.	5
Descriptions Used in this Manual.	5
Operating System References.	5
Copyright.	6
Trademarks.	7

Important Instructions

Safety Instructions.	9
Restrictions on Copying.	10

Product Features

Scanning Passports or Booklets.	12
Notification of Dirt on the Glass Surface.	12
Useful Image Quality Adjustment Features.	13

Scanner Basics

Part Names and Functions.	17
Position of Scanner.	20
Buttons and Lights on the Control Panel.	21
Buttons.	21
Lights.	22
Error Indicators.	23
Information on Applications.	23
Application for Scanning Documents (Document Capture Pro / Document Capture).	24
Application for Controlling the Scanner (Epson Scan 2).	24
Application for Updating Software and Firmware (EPSON Software Updater).	25
Software for Managing Devices on the Network (Epson Device Admin).	25
Application for Creating Driver Packages (EpsonNet SetupManager).	26
Application for Scanning Business Cards (Presto! BizCard).	26
Option Items and Consumables Information.	26
Carrier Sheet Codes.	26
Roller Assembly Kit Codes.	27
Cleaning Kit Codes.	28

Placing Originals

Specifications for Originals that can be Scanned.	30
General Specifications for Originals Being Scanned.	30
Scannable Standard Size Originals.	30
Scannable Large Originals.	32
Scannable Long Paper.	32
Scannable Receipts.	33
Scannable Plastic Cards.	34
Scannable Laminated Cards.	35
Scannable Booklets.	35
Passports.	36
Specifications for Originals Using the Carrier Sheet.	36
Scannable Envelopes.	37
Types of Originals that Require Attention.	38
Types of Originals that Must Not be Scanned.	39
Placing Originals in the Scanner.	40
Combinations of Originals and Scanner Position.	40
Placing Standard Size Originals.	42
Placing Large Size Originals.	47
Placing Long Paper.	51
Placing Plastic Cards.	55
Placing Laminated Cards.	59
Placing a Booklet.	62
Placing a Passport.	65
Placing Important Originals or Photos.	70
Placing an Envelope.	74
Placing Irregular Shaped Originals.	78
Loading Batches of Originals with Different Paper Types and Sizes.	82

Scanning

Scanning Using a Scanner Button.	87
Scanning from a Computer.	87
Scanning Using Document Capture Pro (Windows).	87
Scanning Using Document Capture (Mac OS).	93
Scanning Using Epson Scan 2.	99
Software Image Quality Adjustment Features.	104
Scanning in Automatic Feeding Mode.	104
Setting a Job.	106
Creating a Job and Assigning a Job to the Control Panel (Windows).	106
Creating and Registering a Job (Mac OS).	106

Assigning a Job to the Control Panel (Mac OS). 107

Useful Features

Setting the Glass Surface Stain Detection Feature. . 109

Setting the Document Protection Feature. 110

Setting the Operation when a Double-feed is Detected. 111

Maintenance

Cleaning Outside the Scanner. 114

Cleaning Inside the Scanner. 114

Resetting the Number of Scans After Cleaning Inside the Scanner. 122

Replacing the Roller Assembly Kit. 124

Resetting the Number of Scans After Replacing the Rollers. 131

Energy Saving. 132

Moving the Scanner. 133

Transporting the Scanner. 133

How to Carry the Scanner. 134

Updating Applications and Firmware. 135

Updating Firmware without Connecting to the Internet. 136

Solving Problems

Problems with the Scanner. 138

Scanner Lights Indicate an Error. 138

The Scanner Does Not Turn On. 138

Problems Starting Scanning. 138

Cannot Start Scanning from Computer. 138

Paper Feeding Problems. 141

Multiple Originals Are Fed (Double Feed). . . . 141

Removing Jammed Originals from the Scanner. 142

Paper Jams, Paper Feed Errors, and

Document Protection Issues Occur Frequently. 148

Paper Protection Does not Work Correctly. . . 149

The Originals Get Dirty. 149

Scanning Speed Slows Down when Scanning

Continuously. 149

Scanning Takes a Long Time. 150

Scanned Image Problems. 150

Lines (Streaks) Appear when Scanning from ADF. 150

Alert About Stains Inside the Scanner Still Appears. 151

Colors Are Uneven in the Scanned Image. . . . 151

Expanding or Contracting the Scanned Image. . 151

An Image on the Back of Your Original Appears in Your Scanned Image. 152

Scanned Text or Images are Missing or Blurred. 152

Moiré Patterns (Web-Like Shadows) Appear. . . 152

The Edge of the Original is Not Scanned when Automatically Detecting the Size of the Original. 153

Character is not Recognized Correctly. 153

Cannot Solve Problems in the Scanned Image. . 154

Document Capture Pro Problems. 154

Uninstalling and Installing Applications. 155

Uninstalling Your Applications. 155

Installing Your Applications. 156

Technical Specifications

General Scanner Specifications. 158

Dimensions and Weight Specifications. 159

Electrical Specifications. 160

Scanner Electrical Specifications. 160

AC Adapter Electrical Specifications. 160

Environmental Specifications. 160

System Requirements. 161

Standards and Approvals

Standards and Approvals for European Models. . . 163

Standards and Approvals for U.S. Models. 163

OPEN SOURCE SOFTWARE LICENSE. 163

SHA1 license. 163

Info-ZIP license. 164

lua license. 165

Where to Get Help

Technical Support Web Site. 167

Contacting Epson Support. 167

Before Contacting Epson. 167

Help for Users in Europe. 167

Help for Users in Taiwan. 167

Help for Users in Singapore. 168

Help for Users in Thailand. 168

Help for Users in Vietnam. 169

Help for Users in Indonesia. 169

Help for Users in Hong Kong. 169

Help for Users in Malaysia. 170

Help for Users in India. 170

Help for Users in the Philippines. 171



About This Manual

Introduction to the Manuals.	5
Marks and Symbols.	5
Descriptions Used in this Manual.	5
Operating System References.	5
Copyright.	6
Trademarks.	7

Introduction to the Manuals

The latest versions of the following manuals are available from the Epson support website.

<http://www.epson.eu/support> (Europe)

<http://support.epson.net/> (outside Europe)

Start Here (paper manual)

Provides you with information on setting up the product and installing the application.

User's Guide (digital manual)

Provides instructions on using the product, maintenance, and solving problems.

As well as the manuals above, see the help included in the various Epson applications.

Marks and Symbols



Caution:

Instructions that must be followed carefully to avoid bodily injury.



Important:

Instructions that must be observed to avoid damage to your equipment.

Note:

Provides complementary and reference information.

Related Information

➔ Links to related sections.

Descriptions Used in this Manual

Screenshots for the applications are from Windows 10 or macOS High Sierra. The content displayed on the screens varies depending on the model and situation.

Illustrations used in this manual are for reference only. Although they may differ slightly from the actual product, the operating methods are the same.

Operating System References

Windows

In this manual, terms such as "Windows 11", "Windows 10", "Windows 8.1", "Windows 8", "Windows 7", "Windows Server 2022", "Windows Server 2019", "Windows Server 2016", "Windows Server 2012 R2", "Windows Server 2012", "Windows Server 2008 R2", and "Windows Server 2008" refer to the following operating systems. Additionally, "Windows" is used to refer to all versions and "Windows Server" is used to refer to "Windows Server

2022", "Windows Server 2019", "Windows Server 2016", "Windows Server 2012 R2", "Windows Server 2012", "Windows Server 2008 R2", and "Windows Server 2008".

- Microsoft® Windows® 11 operating system
- Microsoft® Windows® 10 operating system
- Microsoft® Windows® 8.1 operating system
- Microsoft® Windows® 8 operating system
- Microsoft® Windows® 7 operating system
- Microsoft® Windows Server® 2022 operating system
- Microsoft® Windows Server® 2019 operating system
- Microsoft® Windows Server® 2016 operating system
- Microsoft® Windows Server® 2012 R2 operating system
- Microsoft® Windows Server® 2012 operating system
- Microsoft® Windows Server® 2008 R2 operating system
- Microsoft® Windows Server® 2008 operating system

Mac OS

In this manual, terms such as "macOS 12.x", "macOS 11.x", "macOS 10.15.x", "macOS 10.14.x", "macOS 10.13.x", "macOS 10.12.x", "OS X 10.11.x", "OS X 10.10.x", and "OS X 10.9.x" are collectively referred to as "Mac OS".

Copyright

No part of this publication may be reproduced, stored in a retrieval system, or transmitted in any form or by any means, electronic, mechanical, photocopying, recording, or otherwise, without the prior written permission of Seiko Epson Corporation. No patent liability is assumed with respect to the use of the information contained herein. Neither is any liability assumed for damages resulting from the use of the information herein. The information contained herein is designed only for use with this Epson product. Epson is not responsible for any use of this information as applied to other products.

Neither Seiko Epson Corporation nor its affiliates shall be liable to the purchaser of this product or third parties for damages, losses, costs, or expenses incurred by the purchaser or third parties as a result of accident, misuse, or abuse of this product or unauthorized modifications, repairs, or alterations to this product, or (excluding the U.S.) failure to strictly comply with Seiko Epson Corporation's operating and maintenance instructions.

Seiko Epson Corporation and its affiliates shall not be liable for any damages or problems arising from the use of any options or any consumable products other than those designated as Original Epson Products or Epson Approved Products by Seiko Epson Corporation.

Seiko Epson Corporation shall not be held liable for any damage resulting from electromagnetic interference that occurs from the use of any interface cables other than those designated as Epson Approved Products by Seiko Epson Corporation.

© 2023 Seiko Epson Corporation

The contents of this manual and the specifications of this product are subject to change without notice.

Trademarks

- ❑ EPSON, EPSON EXCEED YOUR VISION, EXCEED YOUR VISION and their logos are registered trademarks or trademarks of Seiko Epson.
- ❑ Microsoft®, Windows®, and Windows Server® are registered trademarks of Microsoft Corporation.
- ❑ Apple, Mac, macOS, and OS X are trademarks of Apple Inc., registered in the U.S. and other countries.
- ❑ General Notice: Other product names used herein are for identification purposes only and may be trademarks of their respective owners. Epson disclaims any and all rights in those marks.

Important Instructions

Safety Instructions.	9
Restrictions on Copying.	10

Safety Instructions

Read and follow these instructions to ensure safe use of this product and options. Make sure you keep this manual for future reference. Also, be sure to follow all warnings and instructions marked on the product and options.

- ❑ Some of the symbols used on your product and options are to ensure safety and proper use of the product. Visit the following Web site to learn the meaning of the symbols.

<http://support.epson.net/symbols>

- ❑ Place the product and options on a flat, stable surface that extends beyond the base of the product and options in all directions. If you place the product and options by the wall, leave more than 10 cm between the back of the product and options and the wall.
- ❑ Place the product and options close enough to the computer for the interface cable to reach it easily. Do not place or store the product and options or the AC adapter outdoors, near excessive dirt or dust, water, heat sources, or in locations subject to shocks, vibrations, high temperature or humidity, direct sunlight, strong light sources, or rapid changes in temperature or humidity.
- ❑ Do not use with wet hands.
- ❑ Place the product and options near an electrical outlet where the adapter can be easily unplugged.
- ❑ The AC adapter cord should be placed to avoid abrasions, cuts, fraying, crimping, and kinking. Do not place objects on top of the cord and do not allow the AC adapter or the cord to be stepped on or run over. Be particularly careful to keep the cord straight at the end.
- ❑ Use only the power cord supplied with the product and do not use the cord with any other equipment. Use of other cords with this product or the use of the supplied power cord with other equipment may result in fire or electric shock.
- ❑ Use only the AC adapter that comes with your product. Using any other adapter could cause fire, electrical shock, or injury.
- ❑ The AC adapter is designed for use with the product with which it was included. Do not attempt to use it with other electronic devices unless specified.
- ❑ Use only the type of power source indicated on the AC adapter's label, and always supply power directly from a standard domestic electrical outlet with the AC adapter that meets the relevant local safety standards.
- ❑ When connecting this product and options to a computer or other device with a cable, ensure the correct orientation of the connectors. Each connector has only one correct orientation. Inserting a connector in the wrong orientation may damage both devices connected by the cable.
- ❑ Avoid using outlets on the same circuit as photocopiers or air control systems that regularly switch on and off.
- ❑ If you use an extension cord with the product, make sure the total ampere rating of the devices plugged into the extension cord does not exceed the cord's ampere rating. Also, make sure the total ampere rating of all devices plugged into the wall outlet does not exceed the wall outlet's ampere rating.
- ❑ Never disassemble, modify, or attempt to repair the AC adapter, product, or product options by yourself except as specifically explained in the product's guides.
- ❑ Do not insert objects into any opening as they may touch dangerous voltage points or short out parts. Beware of electrical shock hazards.
- ❑ If damage occurs to the plug, replace the cord set or consult a qualified electrician. If there are fuses in the plug, make sure you replace them with fuses of the correct size and rating.
- ❑ Unplug the product, options, and the AC adapter, and refer servicing to qualified service personnel under the following conditions: The AC adapter or plug is damaged; liquid has entered the product, options, or the AC adapter; the product or the AC adapter has been dropped or the case has been damaged; the product, options, or the AC adapter does not operate normally or exhibits a distinct change in performance. (Do not adjust controls that are not covered by the operating instructions.)

- Unplug the product and the AC adapter before cleaning. Clean with a damp cloth only. Do not use liquid or aerosol cleaners except as specifically explained in the product's guides.
- If you are not going to use the product for a long period, be sure to unplug the AC adapter from the electrical outlet.
- After replacing consumable parts, dispose of them correctly following the rules of your local authority. Do not disassemble them.

Restrictions on Copying

Observe the following restrictions to ensure the responsible and legal use of your product.

Copying of the following items is prohibited by law:

- Bank bills, coins, government-issued marketable securities, government bond securities, and municipal securities
- Unused postage stamps, pre-stamped postcards, and other official postal items bearing valid postage
- Government-issued revenue stamps, and securities issued according to legal procedure

Exercise caution when copying the following items:

- Private marketable securities (stock certificates, negotiable notes, checks, etc.), monthly passes, concession tickets, etc.
- Passports, driver's licenses, warrants of fitness, road passes, food stamps, tickets, etc.

Note:

Copying these items may also be prohibited by law.

Responsible use of copyrighted materials:

Products can be misused by improperly copying copyrighted materials. Unless acting on the advice of a knowledgeable attorney, be responsible and respectful by obtaining the permission of the copyright holder before copying published material.



Product Features

Scanning Passports or Booklets.	12
Notification of Dirt on the Glass Surface.	12
Useful Image Quality Adjustment Features.	13

Scanning Passports or Booklets

You can scan originals such as passports or booklets by changing to the straight path position.

Scanning software allows you to save only the identification pages of your passport. (for Windows only)

See the scanner driver (Epson Scan 2) help for more details.

Document Capture Pro allows you to read the MRZ (Machine Readable Zone) of a passport and convert information such as the name, nationality, and passport number into text data, which can then be exported in CSV or XML format. (for Windows only)

See the following for more details.

<https://support.epson.net/dcp/>

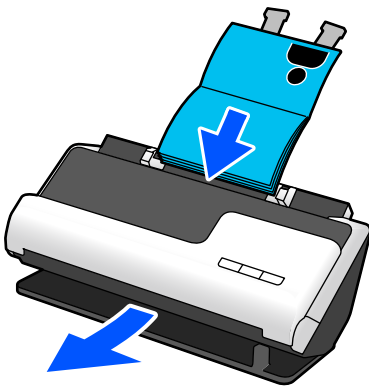

Related Information

- ➔ “Position of Scanner” on page 20
- ➔ “Passports” on page 36
- ➔ “Scannable Booklets” on page 35

Notification of Dirt on the Glass Surface

This scanner can detect dirt on the glass surface, and notify you that you need to clean the glass surface before dirt can cause lines (streaks) in the scanned images.

You can easily keep the glass surface clean, and avoid a decline in image quality.

This feature is off by default.

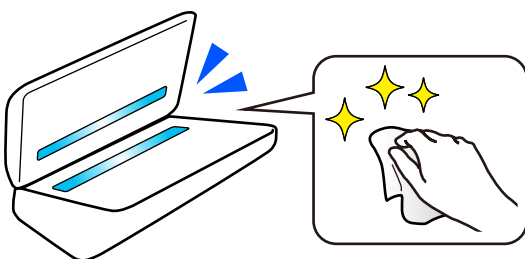

Related Information

- ➔ “Setting the Glass Surface Stain Detection Feature” on page 109
- ➔ “Cleaning Inside the Scanner” on page 114

Useful Image Quality Adjustment Features

Automatically Scan at the Optimum color

You can automatically detect the color of the original and then scan it. Even when color and black-and-white originals are mixed, they can be automatically scanned at the optimum color (Image Type).

Color original: Scan using Color.

Black-and-white originals with gradation (gray areas): Scan using Gray.

Black-and-white originals without gradation (no gray areas): Scan using B&W.

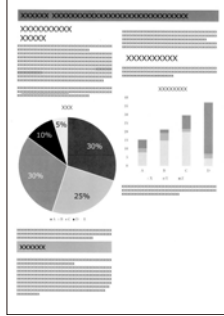
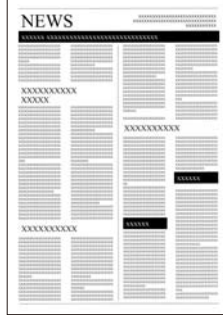
<p>Example of original</p>			
<p>Image Type to be identified</p>	<p>Color</p>	<p>Gray</p>	<p>B&W</p>

Select **Auto** as the **Image Type** in the scanner driver (Epson Scan 2).

Text Enhancement Feature

You can clearly scan text that is difficult to read due to backgrounds and other factors. You can emphasize text and remove dotted patterns in the background of the original according to the original.

You can set this on the **Advanced Settings** tab > **Text Enhancement** > **Settings** in the scanner driver (Epson Scan 2).

When scanning in Color or Gray

The following features are available.

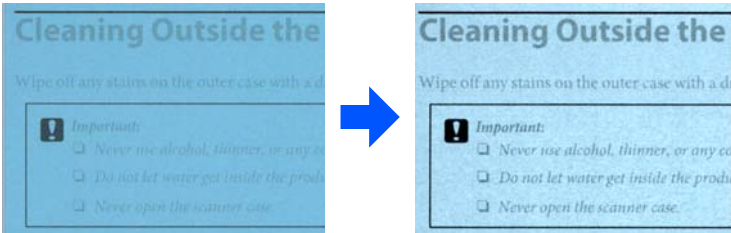
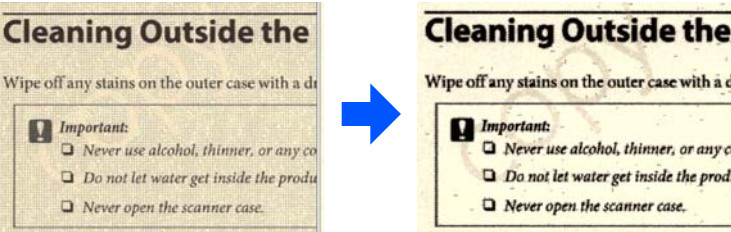
Features	Explanations
<p>Emphasize light letters for OCR</p>	<p>You can emphasize light letters so that they can be more easily recognized by OCR. You can adjust the level of the effect.</p> 
<p>Remove halftone dots</p>	<p>When scanning in Color or Gray, turn this on to remove dotted patterns in the background of the original.</p> 

When scanning in B&W

The following features are available.

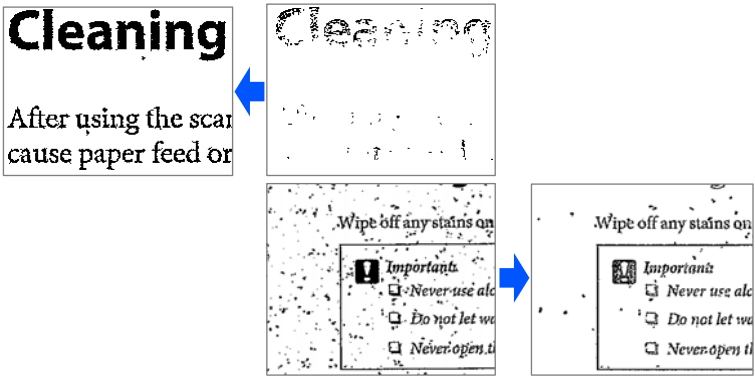
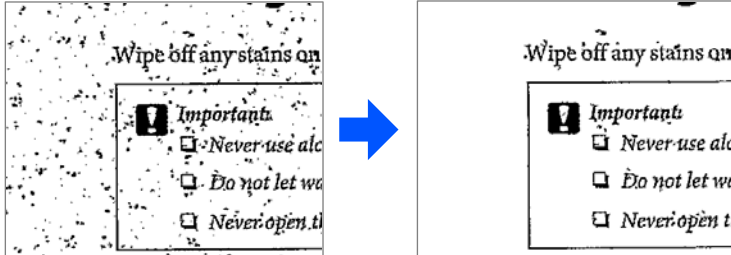
Features	Explanations
<p>Emphasize light letters / Remove background</p>	<p>You can set the level of text and background correction to enhance light text, remove background colors, patterns, wrinkles, and offset.</p> 
<p>Remove spot noise</p>	<p>You can remove black dots in the background of the original that cannot be removed by lightening the background. You can adjust the level of the effect.</p> 

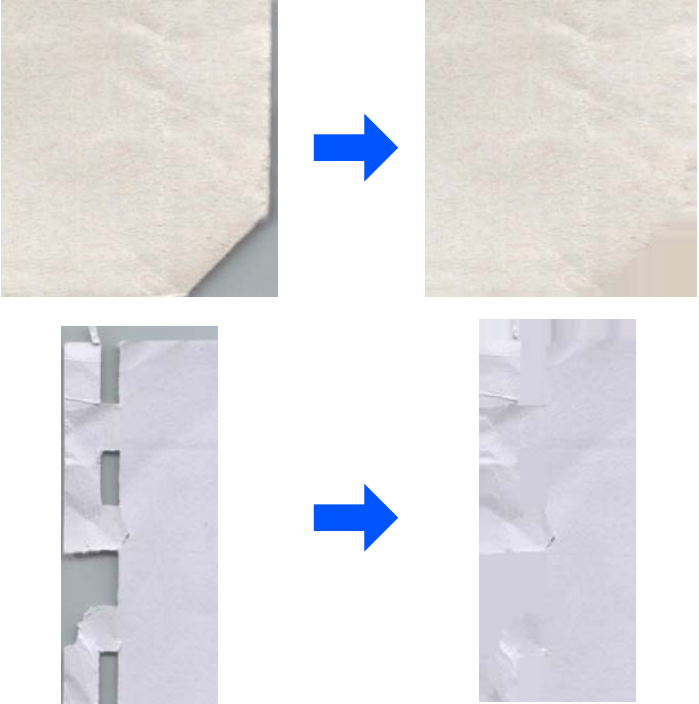
Features	Explanations
Correct folds or tears	<p>You can correct scanned images when the corners or the edges of the original are folded or torn, or when a shadow appears around the scanned image. The missing edges or corners of the scanned image will be filled with the color of the original document.</p> 

Related Information

➔ [“Software Image Quality Adjustment Features” on page 104](#)

Scanner Basics

Part Names and Functions.	17
Position of Scanner.	20
Buttons and Lights on the Control Panel.	21
Information on Applications.	23
Option Items and Consumables Information.	26

Part Names and Functions

Front

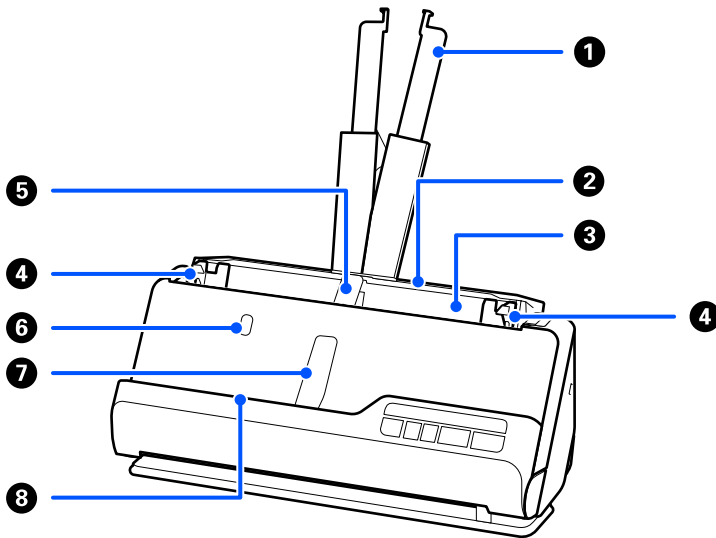

1	Input tray extension	Pull this out if the original extends beyond the edges of the tray. This prevents paper from curling and causing paper jams.
2	Input tray	Loads originals.
3	ADF (Automatic Document Feeder)	Feeds loaded originals automatically.
4	Edge guides	Use guides to supports the original in the input tray to facilitate a smooth feeding operation. Slide to the edges of the originals.
5	Input tray paper support	Supports the ejected original on the input tray side so that it is ejected correctly.
6	Input tray paper support button	Press this button to raise the input tray paper support. Store the paper support manually.
7	Output tray paper support	Supports the ejected original on the output tray side so that it is ejected correctly.
8	Output tray paper support button	Press this button to raise the output tray paper support. Store the paper support manually.

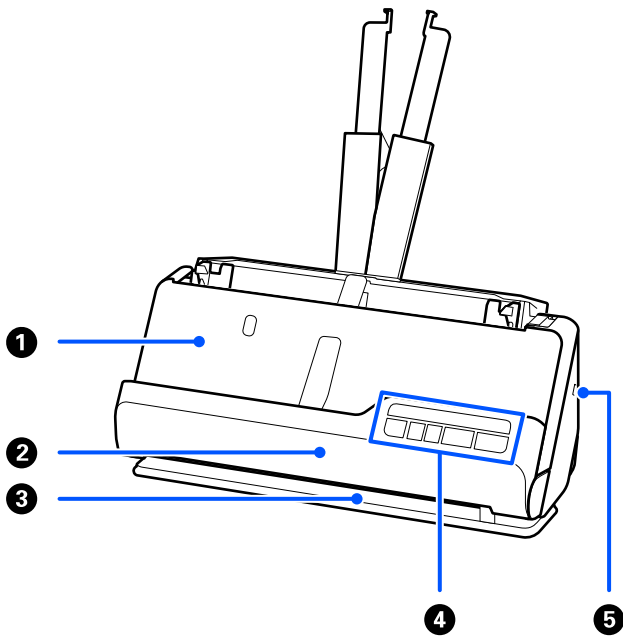

①	Output tray	Originals scanned in the vertical path position are ejected from here.
②	Vertical path cover	Open when cleaning the inside of the scanner, or when an original is jammed while scanning in the vertical path position.
③	Output slot	Originals scanned in the straight path position are ejected from here.
④	Control panel	Displays the scanner's status and performs scanner operations.
⑤	Security slot	Insert a security lock for theft prevention.

Side / Rear

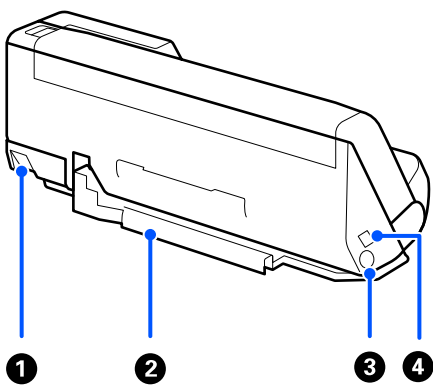

①	Scanner position selector	Used to change the scanner position between vertical path position and straight path position.
---	---------------------------	--

<p>②</p>	<p>Cable holder</p>	<p>Secures the cables neatly to the scanner at the bottom.</p> <p>! Important: <i>Do not secure the AC adapter cord and USB cable to the cable holder in the following situations.</i></p> <ul style="list-style-type: none"> <input type="checkbox"/> <i>If the scanner or other objects are placed on top of the cord and cable</i> <input type="checkbox"/> <i>If the cords and cables are twisted, extremely bent, or otherwise placed under stress</i> <input type="checkbox"/> <i>If the cords and cables are tangled</i>
<p>③</p>	<p>DC inlet</p>	<p>Connects the AC adapter.</p>
<p>④</p>	<p>USB port</p>	<p>Connects a USB cable.</p>

Inside

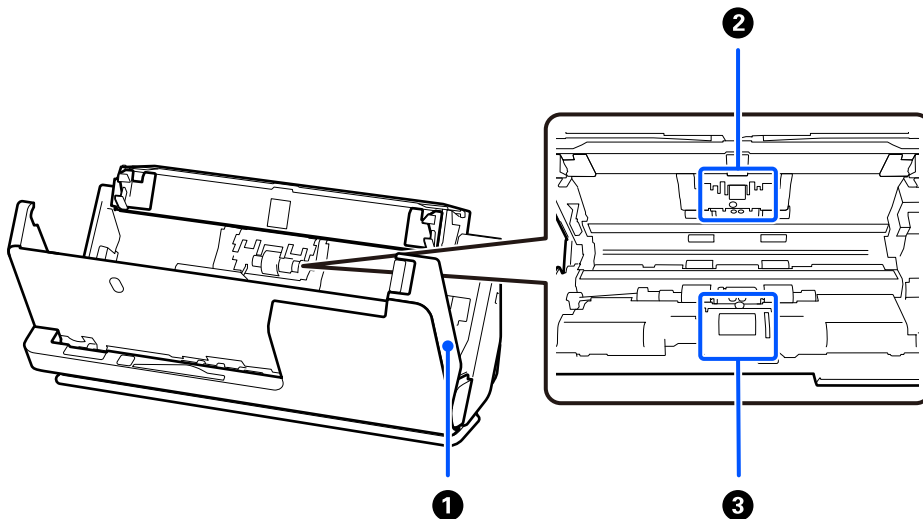

<p>①</p>	<p>Scanner cover</p>	<p>Pull the lever and open the scanner cover when cleaning inside the scanner and removing jammed paper.</p>
<p>②</p>	<p>Separation roller</p>	<p>Feeds originals separately one by one. This needs to be replaced when the number of scans exceeds the service number of papers.</p>
<p>③</p>	<p>Pickup roller</p>	<p>Feeds originals. Roller needs to be replaced when the number of scans exceeds the service number of papers.</p>

Related Information

- ➔ [“Cleaning Inside the Scanner” on page 114](#)
- ➔ [“Replacing the Roller Assembly Kit” on page 124](#)

Position of Scanner

You can change the position of the scanner according to the usage.



Caution:

Be careful not to pinch your fingers or any cables when you change the position of the scanner. Injury or damage may occur.

See the Related Information page for more information on the combinations of scanner positions and originals.

Vertical path position

When scanning multiple sheets of standard-size originals, or when scanning thin paper or receipts, pull the scanner position selector to tilt the scanner forward into the vertical path position. When scanning in the vertical path position, originals loaded in the input tray are ejected to the output tray at the top of the scanner.

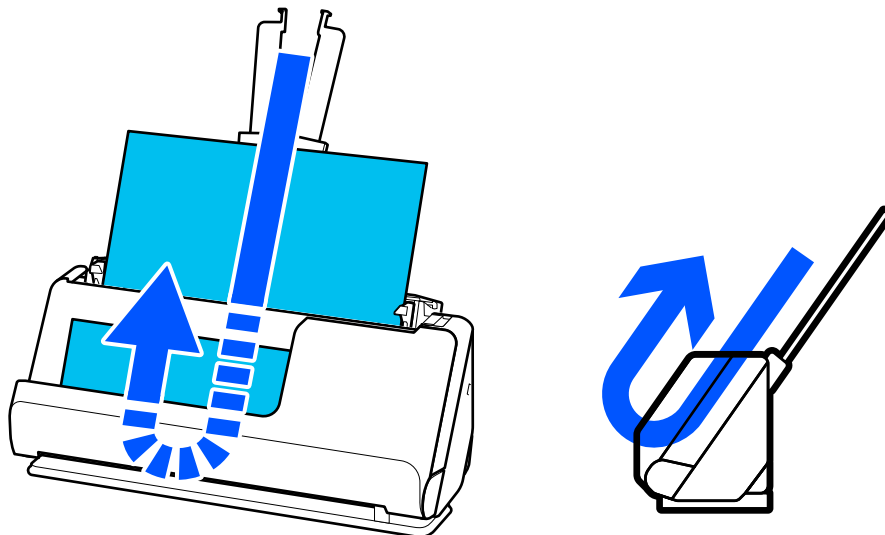

When the vertical path position is changed, the  light on the control panel turns off.

Straight path position

When scanning thick originals such as passports, pull the scanner position selector to tilt the scanner backward to the straight path position. When scanning in the straight path position, originals loaded in the input tray are ejected to the output slot at the front of the scanner.

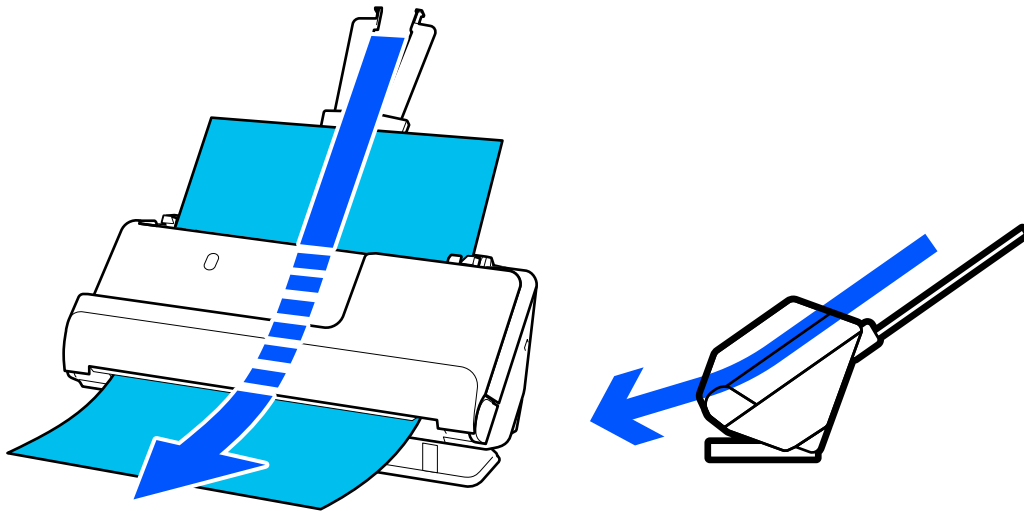

When the scanner is changed to the straight path position, the  light on the control panel turns on.

Related Information

➔ [“Combinations of Originals and Scanner Position” on page 40](#)

Buttons and Lights on the Control Panel

Buttons

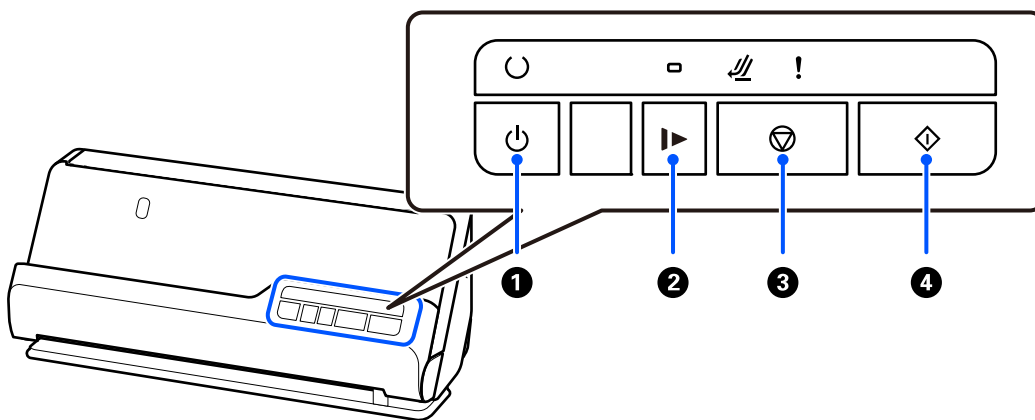

1		Power button	Turns the scanner on or off.
---	---	--------------	------------------------------

2		Slow mode button	<p>Slow down the feeding speed when scanning. The light is on when this is enabled.</p> <p>Press this button in the following situations:</p> <ul style="list-style-type: none"> <input type="checkbox"/> When originals jam frequently <input type="checkbox"/> When loading thin originals
3		Stop button	<ul style="list-style-type: none"> <input type="checkbox"/> Cancels scanning. <input type="checkbox"/> Finishes Automatic Feeding Mode.
4		Start button	<ul style="list-style-type: none"> <input type="checkbox"/> Starts scanning. <input type="checkbox"/> Press this when cleaning the inside of the scanner.

Lights

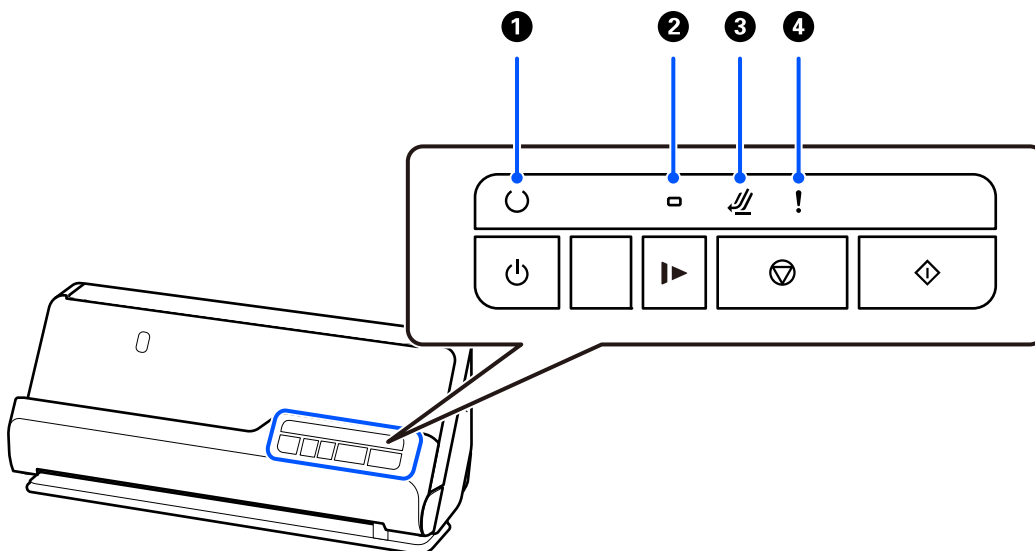











1		Ready light	On: The scanner is ready to be used.
			Flashing: The scanner is scanning, waiting to scan, processing, or sleeping.
			Off: The scanner cannot be used because the power is off or an error has occurred.
2		Slow mode light	Turns on during slow mode.
3		Scanner position light	Turns on when the scanner is in the straight path position.
4		Error light	An error has occurred. See "Error Indicators" for more details.

Related Information

➔ ["Error Indicators" on page 23](#)

Error Indicators

Scanner Errors

Indicator	Status	Solutions
!Flashing	A paper jam or double feed has occurred.	<p>Open the scanner cover, and then remove jammed originals. Close the scanner cover to clear the error. Load the originals again.</p> <p>This product uses two different positions for scanning, depending on the original being scanned. Check the link to see which position is appropriate for your original.</p> <p>"Combinations of Originals and Scanner Position" on page 40</p>
!On	The scanner cover is opened.	Close the scanner cover.
 Flashing !On	The scanner position was changed during scanning.	Open the scanner cover, remove the original, and return the scanner to its original position.
 Flashing fast	The scanner position has not been set.	Set the scanner in the vertical path position or straight path position.
 Flashing fast  Flashing fast  Flashing fast  Flashing fast	A fatal error has occurred.	Turn the power off and on again. If the error continues to occur, contact your dealer.
 Off  On  On  On	The scanner has started in recovery mode because the firmware update failed.	<p>The scanner has started in recovery mode because the firmware update failed.</p> <ol style="list-style-type: none"> 1. Connect the computer and the scanner by USB. 2. Download the latest firmware from the Epson home page, and then start the update.

Related Information

➔ ["Removing Jammed Originals from the Scanner" on page 142](#)

Information on Applications

This section introduces the application products available for your scanner. The latest application can be installed at the Epson Web site.

Application for Scanning Documents (Document Capture Pro / Document Capture)

Document Capture Pro* is an application that allows you to efficiently scan originals such as documents.

You can register a set of operations, such as Scan-Save-Send, as a “job”. By registering a series of operations in advance as a job, you can perform all of the operations by simply selecting the job. By assigning a job to the button on scanner's control panel, you can start a job by pressing the button.

See the Document Capture Pro help (Windows) or Document Capture (Mac OS) for details on using the application.

* This name is for Windows. For Mac OS, the name is Document Capture.

Starting on Windows

Windows 11

Click the start button, and then select **All apps > Epson Software > Document Capture Pro**.

Windows 10

Click the start button, and then select **Epson Software > Document Capture Pro**.

Windows 8.1/Windows 8

Enter the application name in the search charm, and then select the displayed icon.

Windows 7

Click the start button, and then select **All Programs > Epson Software > Document Capture Pro**.

Starting on Mac OS

Select **Go > Applications > Epson Software > Document Capture**.

Application for Controlling the Scanner (Epson Scan 2)

Epson Scan 2 is a scanner driver that allows you to control the scanner. You can adjust the size, resolution, brightness, contrast, and quality of the scanned image. You can also start this application from a TWAIN-compliant scanning application.

See the Epson Scan 2 help for details on using the application.

Starting on Windows

Note:

*For Windows Server operating systems, make sure the **Desktop Experience** feature is installed.*

Windows 11/Windows Server 2022

Click the start button, and then select **All apps > EPSON > Epson Scan 2**.

Windows 10/Windows Server 2016/Windows Server 2019

Click the start button, and then select **EPSON > Epson Scan 2**.

Windows 8.1/Windows 8/Windows Server 2012 R2/Windows Server 2012

Enter the application name in the search charm, and then select the displayed icon.

Windows 7/Windows Server 2008 R2/Windows Server 2008

Click the start button, and then select **All Programs** or **Programs > EPSON > Epson Scan 2 > Epson Scan 2**.

Starting on Mac OS

Select **Go > Application > Epson Software > Epson Scan 2**.

Application for Updating Software and Firmware (EPSON Software Updater)

EPSON Software Updater is an application that installs new software, and updates firmware and manuals over the Internet. If you want to check for update information regularly, you can set the interval for checking for updates in EPSON Software Updater's auto update settings.

Note:

Windows Server operating systems are not supported.

Starting on Windows

Windows 11

Click the start button, and then select **All apps > Epson Software > EPSON Software Updater**.

Windows 10

Click the start button, and then select **Epson Software > EPSON Software Updater**.

Windows 8.1/Windows 8

Enter the application name in the search charm, and then select the displayed icon.

Windows 7

Click the start button, and then select **All Programs > Epson Software > EPSON Software Updater**.

Starting on Mac OS

Select **Go > Applications > Epson Software > EPSON Software Updater**.

Software for Managing Devices on the Network (Epson Device Admin)

Epson Device Admin is a multifunctional application software that manages the device on the network.

The following functions are available.

- Monitor or manage up to 2,000 printers or scanners over the segment
- Make a detailed report, such as for the consumable or product status
- Update the firmware of the product
- Introduce the device to the network
- Apply the unified settings to multiple devices.

You can download Epson Device Admin from Epson support website. For more information, see the documentation or help of Epson Device Admin.

Application for Creating Driver Packages (EpsonNet SetupManager)

EpsonNet SetupManager is a software to create a package for a simple scanner installation, such as installing the scanner driver and so on. This software allows the administrator to create unique software packages and distribute them among groups.

For more information, visit your regional Epson website.

<http://www.epson.com>

Application for Scanning Business Cards (Presto! BizCard)

Presto! BizCard by NewSoft provides a full range of contact management functions for adding business cards without having to type. Use the BizCard recognition system to scan business cards, edit, and synchronize the information to the most frequently used personal database management software. You can easily save and manage your contact information.

See the software's help for more information on using the software and its functions.

Starting on Windows

Windows 11

Click the start button, and then select **All apps > NewSoft > Presto! BizCard**.

Windows 10

Click the start button, and then select **NewSoft > Presto! BizCard**.

Windows 8.1/Windows 8

Enter the application name in the search charm, and then select the displayed icon.

Windows 7

Click the start button, and then select **All Programs > NewSoft > Presto! BizCard**.

Starting on Mac OS

Select **Go > Applications > Presto! BizCard**.

Option Items and Consumables Information

Carrier Sheet Codes

Using a Carrier Sheet allows you to scan irregular shaped originals or photos that can easily be scratched. You can only load one Carrier Sheet in the straight path position.

You can scan passports as is, but if you want to protect the passport while scanning, use a passport carrier sheet.

Part Name	Codes*1	Number of Times Carrier Sheet Can be Used
Carrier Sheet	B12B819051	3,000*2

Part Name	Codes* ¹	Number of Times Carrier Sheet Can be Used
Passport Carrier Sheet	B12B819651 B12B819661 (for India)	3,000* ²

*1 You cannot use any Carrier Sheet or Passport Carrier Sheet except for the codes specified.

*2 This number is a guide to the replacement cycle. Do not use a Carrier Sheet or Passport Carrier Sheet that is scratched.

Related Information

- ➔ [“General Specifications for Originals Being Scanned” on page 30](#)
- ➔ [“Placing Large Size Originals” on page 47](#)
- ➔ [“Placing a Booklet” on page 62](#)
- ➔ [“Placing a Passport” on page 65](#)
- ➔ [“Placing Irregular Shaped Originals” on page 78](#)

Roller Assembly Kit Codes

Parts (the pickup roller and separation roller) should be replaced when the number of scans exceeds the service number. You can check the latest number of scans in the Epson Scan 2 Utility.

A



B

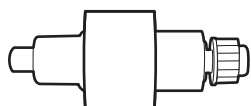

A: Pickup Roller, B: Separation roller

Part Name	Model Number	Life cycle
Roller Assembly Kit	B12B819731 B12B819741 (India only)	50,000*

* This number was reached by consecutively scanning using Epson test original papers, and is a guide to the replacement cycle. The replacement cycle may vary depending on different paper types, such as paper that generates a lot of paper dust or paper with a rough surface that may shorten the life cycle. The replacement timing also depends on the scanning and cleaning frequency.

Related Information

- ➔ [“Replacing the Roller Assembly Kit” on page 124](#)
- ➔ [“Resetting the Number of Scans After Replacing the Rollers” on page 131](#)

Cleaning Kit Codes

Use this when cleaning inside the scanner. This kit is composed of cleaning liquid and a cleaning cloth.

Part name	Codes
Cleaning Kit	B12B819291

Related Information

➔ [“Cleaning Inside the Scanner” on page 114](#)

Placing Originals

Specifications for Originals that can be Scanned.	30
Types of Originals that Require Attention.	38
Types of Originals that Must Not be Scanned.	39
Placing Originals in the Scanner.	40

Specifications for Originals that can be Scanned

This section explains the specifications and conditions of originals that can be loaded in the ADF.

General Specifications for Originals Being Scanned

Type of Original	Thickness	Size
Fine paper	When scanning in the vertical path position: 40 to 127 g/m ²	Max: 215.9×5,588 mm (8.5×220.0 in.) Min: 50.8×50.8 mm (2.0×2.0 in.)
Plain paper		
Recycled paper	When scanning in the straight path position: 40 to 413 g/m ²	The loadable size varies depending on the type of the originals and the scanning resolution.
Post cards		
Business cards	When scanning A6 size or smaller originals: 40 to 209 g/m ²	
Envelopes		
Plastic cards complying with ISO7810 ID-1 type (with or without emboss)		
Laminated cards		
Thermal paper		

Note:

- ❑ All originals must be flat at the leading edge.
- ❑ Make sure that curls on the leading edge of the originals are kept within the following range.
 - ① must be 5 mm or less.
 - ② must be 3 mm or less.
 - ③ must be greater than or equal to ② if ② is less than 1 mm. When ② is greater than 1 mm, it should be at least 10 times the size of ②.

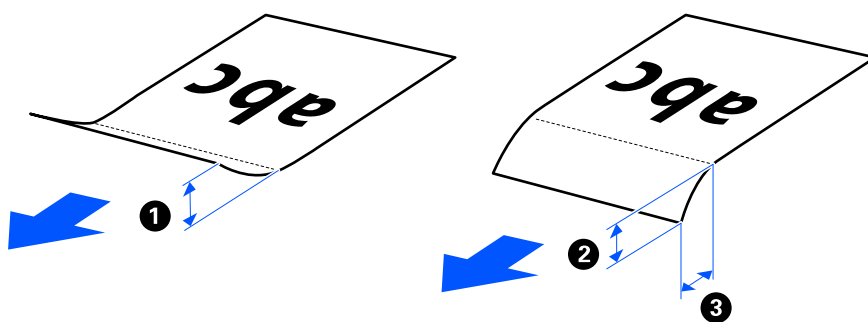

- ❑ Even when the original meets the specifications for originals that can be placed in the ADF, it may not feed from the ADF depending on the paper properties or quality. Additionally, some originals may decrease the scan quality.

Scannable Standard Size Originals

These are the specifications for standard size originals that you can scan.

Specifications	Size	Thickness	Paper type	Loading Capacity and Thickness
Legal	215.9×355.6 mm (8.5×14 in.)	<input type="checkbox"/> For the vertical path position 40 to 127 g/m ² <input type="checkbox"/> For the Straight Path Position 40 to 413 g/m ²	Plain paper Fine paper Recycled paper	<input type="checkbox"/> For the vertical path position Thickness of the stack of originals: under 2.4 mm (0.09 in.) 40 g/m ² : 20 sheets* 80 g/m ² : 20 sheets 90 g/m ² : 18 sheets 104 g/m ² : 15 sheets 127 g/m ² : 12 sheets <input type="checkbox"/> For the Straight Path Position 1 sheet The loading capacity varies depending on the paper type.
Letter	215.9×279.4 mm (8.5×11 in.)			
A4	210×297 mm (8.3×11.7 in.)			
B5	182×257 mm (7.2×10.1 in.)			
A5	148×210 mm (5.8×8.3 in.)			
B6	128×182 mm (5.0×7.2 in.)			
A6	105×148 mm (4.1×5.8 in.)			
A8	52×74 mm (2.1×2.9 in.)	<input type="checkbox"/> For the Straight Path Position 40 to 413 g/m ²		
Business cards	55×89 mm (2.1×3.4 in.)	210 g/m ²	<input type="checkbox"/> For the vertical path position Thickness of the stack of originals: under 2.4 mm (0.09 in.) 5 sheets <input type="checkbox"/> For the straight path position 1 sheet	

* When scanning thin paper originals, we recommend extending the paper output support in both places.

When Scanning Standard Size Originals (Check the Position of the Scanner)

When scanning standard size, plain paper originals, scan in the vertical path position.

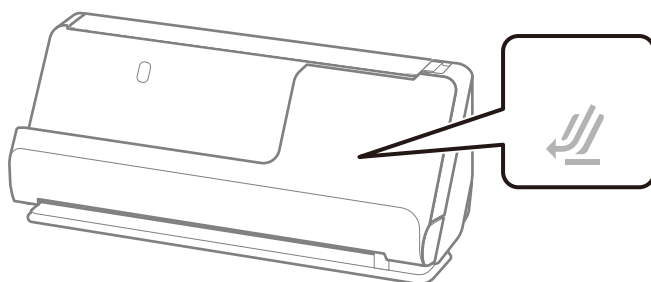

- ❑ When scanning award certificates and other thick originals (originals with a thickness 127 g/m² or more), scan in the straight path position and load only one original at a time.

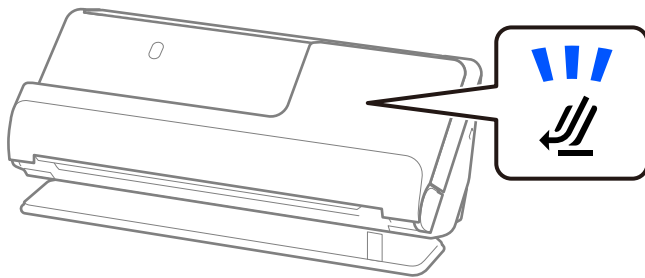

Related Information

- ➔ [“Placing Standard Size Originals” on page 42](#)
- ➔ [“Placing Large Size Originals” on page 47](#)

Scannable Large Originals

These are the specifications for large originals that you can scan.

Specifications	Size	Thickness	Paper type	Loading Capacity
A3	297×420 mm (11.7×16.5 in.)	40 to 206 g/m ²	Plain paper	1 card
B4	257×364 mm (10.1×14.3 in.)		Fine paper Recycled paper	

When Scanning Large Originals (Check the Position of the Scanner)

When scanning large originals, scan in the straight path position.

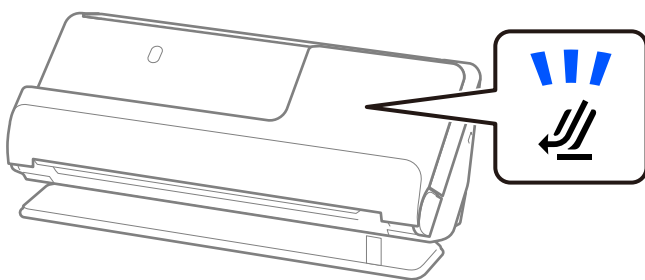

Related Information

- ➔ [“Placing Large Size Originals” on page 47](#)

Scannable Long Paper

These are the specifications for long paper that you can scan.

Note:

- When scanning long paper, scanning speed is reduced.
- Long paper means originals with a length of 393.8 mm (15.5 in.) or more.

Size	Thickness	Paper type	Loading Capacity
Maximum width: 215.9 mm (8.5 in.) Maximum length: 5,588 mm (220 in.)*	50 to 130 g/m ²	Plain paper Fine paper Recycled paper	1 sheet

* The following shows the maximum lengths according to the scanning resolution.

- 50 to 200 dpi: 5,588.0 mm (220 in.)
- 201 to 300 dpi: 5,461.0 mm (215 in.)
- 301 to 600 dpi: 1,346.0 mm (53 in.)

When Scanning Long Paper (Check the Position of the Scanner)

When scanning long paper, scan in the straight path position.

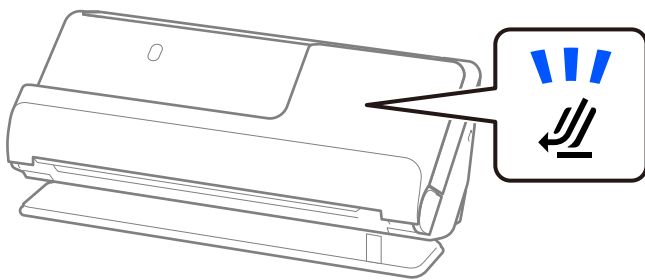

Related Information

➔ [“Placing Long Paper” on page 51](#)

Scannable Receipts

These are the specifications for receipts that you can scan.

Size	Thickness	Loading Capacity and Thickness
Width: 50.8 to 215.9 mm (2.0 to 8.5 in.) Length: 50.8 to 5,588 mm (2.0 to 220.0 in.)* ¹	53 to 77 g/m ²	<ul style="list-style-type: none"> <input type="checkbox"/> For the vertical path position Thickness of the stack of originals: under 2.4 mm (0.09 in.) 20 sheets *² <input type="checkbox"/> For the straight path position 1 sheet

*1 Switch the scanner position according to the length of the receipt to be scanned.

*2 When scanning receipts in the vertical path position, we recommend extending the paper output support in both places.

When Scanning Receipts (Check the Position of the Scanner)

- ❑ When scanning receipts that are shorter than 393.7 mm (15.5 inches), scan in the vertical path position.

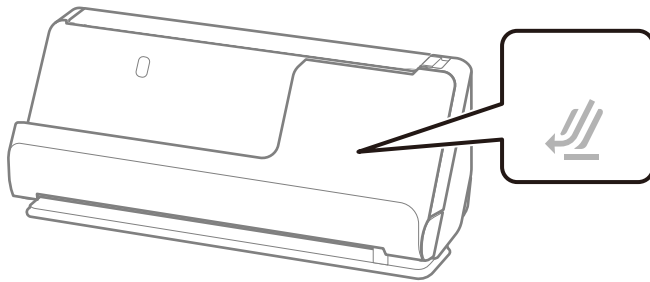

- ❑ When scanning receipts that are longer than 393.7 mm (15.5 inches), place the scanner in the straight path position and load only one original at a time.

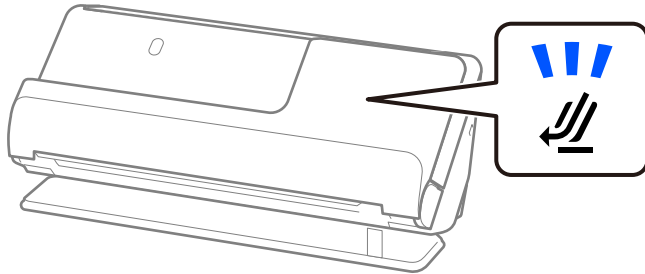

Related Information

- ➔ [“Placing Standard Size Originals” on page 42](#)
- ➔ [“Placing Long Paper” on page 51](#)

Scannable Plastic Cards

These are the specifications for plastic cards that you can scan.

Size	Embossing	Thickness	Loading Capacity	Loading Direction
ISO7810 ID-1 Type 54.0×85.6 mm (2.1×3.3 in.)	With embossing	1.24 mm (0.05 in.) or less	1 card	Horizontal (landscape)
	Without embossing	0.76 mm (0.03 in.) to 1.1 mm (0.04 in)	1 card	
		Less than 0.76 mm (0.03 in.)	1 card	

When Scanning Plastic Cards (Check the Position of the Scanner)

When scanning plastic cards, scan in the straight path position.

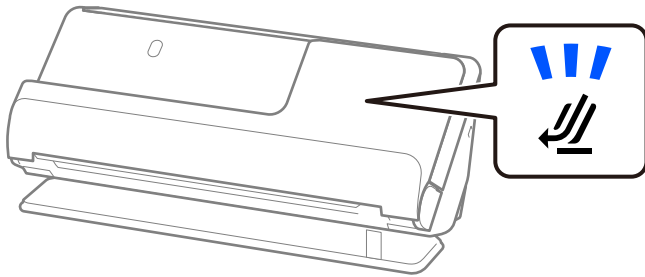

Related Information

➔ [“Placing Plastic Cards” on page 55](#)

Scannable Laminated Cards

These are the specifications for laminated cards that you can scan.

Size	Thickness	Loading Capacity
120.0×150.0 mm (4.7×5.9 in.) or less	0.8 mm (0.03 in.) or less	1 sheet

When Scanning Laminated Cards (Check the Position of the Scanner)

When scanning laminated cards, scan in the straight path position.

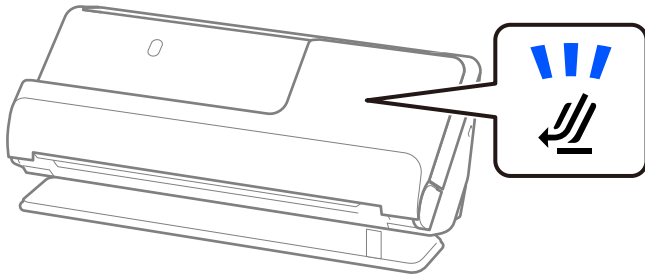

Scannable Booklets

Size	Thickness	Type	Loading Capacity
Max. size: A5 size (A4 in a two-page spread)	5 mm (0.20 in.) or less (The total thickness of the closed booklet)	Passbooks or similar documents	1 booklet

When Scanning Booklets (Check the Position of the Scanner)

When scanning booklets, scan in the straight path position.

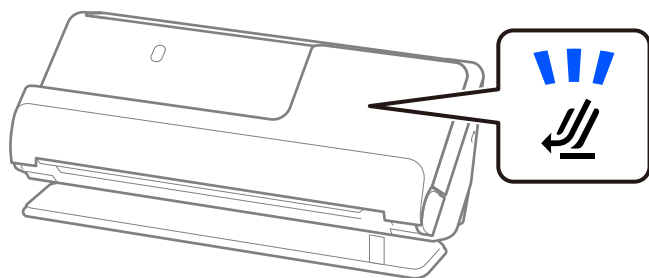

Related Information

➔ [“Placing a Booklet” on page 62](#)

Passports

Thickness	Loading Capacity
5 mm (0.20 in.) or less	1 passport

You can only load one passport at a time, even when scanning with the optional Passport Carrier Sheet.

When Scanning Passports (Check the Position of the Scanner)

When scanning passports, scan in the straight path position.

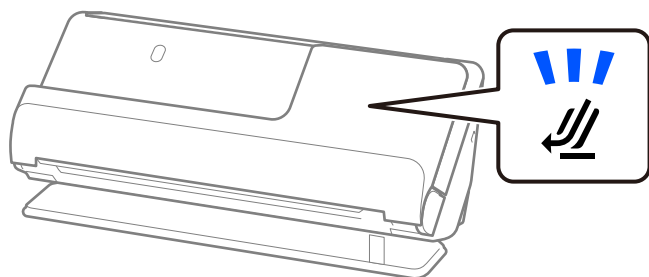

Related Information

➔ [“Placing a Passport” on page 65](#)

Specifications for Originals Using the Carrier Sheet

The optional Carrier Sheet is a sheet designed to transport originals through the scanner. You can scan originals that are larger than A4/Letter size, important documents or photos which must not be damaged, thin paper, irregular shaped originals, and so on.

The following provides a list of originals that can be scanned using the Carrier Sheet.

Type of Original	Size	Thickness	Loading Capacity of the Carrier Sheet
Originals that cannot be loaded directly into the scanner	A3* ¹ A4 B4* ¹ Letter Legal* ¹ B5 A5 B6 A6 A8 Custom size: <input type="checkbox"/> Width: up to 431.8 mm (17 in.) * ² <input type="checkbox"/> Length: up to 297 mm (11.7 in.) * ³	0.3 mm (0.01 in.) or less (Excluding the thickness of the Carrier Sheet)	1 sheet

*1 Fold in half to place.

*2 Originals that are wider than 215.9 mm (8.5 in.) need to be folded in half.

*3 The leading edge of the original must be placed at the binding part of the Carrier Sheet when scanning an original approximately 297 mm (11.7 in.) long. Otherwise, the length of the scanned image may be longer than intended as the scanner scans to the end of the Carrier Sheet when you select **Auto Detect** as the **Document Size** setting in the application.

When Scanning Using a Carrier Sheet (Check the Position of the Scanner)

When scanning using a Carrier Sheet, scan in the straight path position.

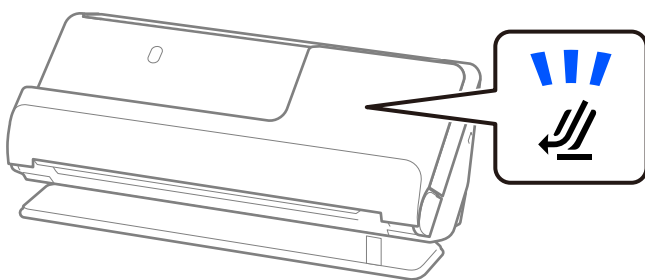

Related Information

- ➔ [“Carrier Sheet Codes” on page 26](#)
- ➔ [“Placing Irregular Shaped Originals” on page 78](#)

Scannable Envelopes

These are the specifications for envelopes that you can scan.

Specifications	Size	Thickness	Loading Capacity
C6	114×162 mm (4.49×6.38 in.) (standard size)	0.38 mm (0.015 in.) or less	1 envelope
DL	110×220 mm (4.33 x 8.66 in.) (standard size)		

When Scanning Envelopes (Check the Position of the Scanner)

When scanning envelopes, scan in the straight path position.

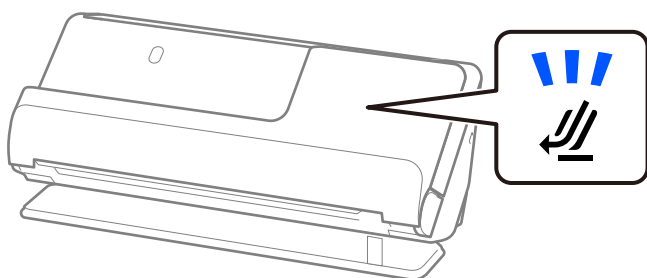

Related Information

➔ [“Placing an Envelope” on page 74](#)

Types of Originals that Require Attention

The following types of originals may not be successfully scanned.

- Originals with specially treated surfaces such as glossy paper, thermal paper, or coated paper.
- Originals with a large uneven surface such as letter head paper.
- Originals that have just been printed
- Originals with fold lines
- Perforated originals
- Original with labels or stickers
- Carbon paper and carbon-less paper
- Curled originals
- Originals with wrinkles or tears

! **Important:**

Carbon-less paper contains chemical substances that may damage the rollers inside the scanner. If you scan carbon-less paper, clean the pickup roller and the separation roller regularly. Also, scanning carbon-less paper may shorten the life cycle of the rollers faster than scanning plain paper.

Note:

- Wrinkled originals may scan better if you slow down the feeding speed during scanning (▶) or smooth out the wrinkles before scanning.
- To scan delicate originals or originals that are easily wrinkled, use a Carrier Sheet (sold separately).
- To scan originals that are incorrectly detected as double feeds, select **Off** in **Detect Double Feed** on the **Main Settings** tab on the Epson Scan 2 screen before scanning.
When you are using Document Capture Pro, you can open the window by pressing the **Detailed Settings** button on the **Scan Settings** screen.
- Labels or stickers must be firmly stuck to the originals with no glue protruding. When scanning an original with labels or stickers that look like they might come off easily, use a carrier sheet and scan the original with the scanner in the straight path position.
- Try to flatten the curled originals before scanning.
- For originals with folds, flatten the original so that the height of the fold is 5 mm (0.2 inches) or less before loading it.
[“Placing Standard Size Originals” on page 42](#)

Related Information

- ➔ [“Scanner Basics” on page 16](#)
- ➔ [“Placing Important Originals or Photos” on page 70](#)
- ➔ [“Placing Irregular Shaped Originals” on page 78](#)
- ➔ [“Maintenance” on page 113](#)

Types of Originals that Must Not be Scanned

The following types of originals must not be scanned.

- Photos
- Booklets
- Passports that are thicker than 5 mm due to visas or supplementary visa pages being stuck inside the passport.
- Non-paper originals (such as clear files, fabric, and metal foil)
- Originals with staples or paper clips
- Originals with glue attached
- Ripped originals
- Heavily wrinkled or curled originals
- Transparent originals such as OHP film
- Originals with carbon paper on the back
- Originals with wet ink
- Originals with sticky notes attached

Note:

- ❑ Do not feed valuable photos, artwork, or important documents, which you do not want to damage or deface, into the scanner directly. Misfeeding may wrinkle or damage the original. When scanning such originals, make sure you use a Carrier Sheet (sold separately).
- ❑ Ripped, wrinkled, or curled originals can also be scanned if you use a Carrier Sheet (sold separately).
- ❑ For thick passports and passports with a slightly expanded binding edge, scan using the Passport Carrier Sheet (sold separately).

Related Information



- ➔ [“Placing Important Originals or Photos” on page 70](#)
- ➔ [“Placing Irregular Shaped Originals” on page 78](#)



Placing Originals in the Scanner

Combinations of Originals and Scanner Position

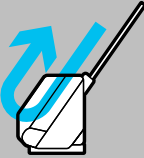
This product uses two different positions for scanning, depending on the original being scanned.

This section explains the combinations of scanner positions and originals. For details on how to change the position, see the Related Information pages or the procedures for placing various types of originals.

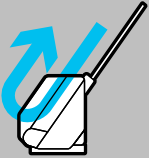
	Vertical path position	Straight path position
		
Explanations	<p>When scanning multiple sheets of standard-size originals, or when scanning thin paper or receipts, place the scanner in the vertical path position.</p> <p>Scanned originals are ejected to the output tray at the top of the scanner.</p>	<p>When scanning thick or long originals, passports, cards, and so on, place the scanner in the straight path position.</p> <p>Scanned originals are ejected to the output slot at the front of the scanner.</p>

	<p style="text-align: center;">Vertical path position</p> 	<p style="text-align: center;">Straight path position</p> 
<p>Supported originals</p>	<ul style="list-style-type: none"> <input type="checkbox"/> Standard size originals (up to A4) <input type="checkbox"/> Thin paper (40 g/m²) <input type="checkbox"/> Post cards <input type="checkbox"/> Receipts less than 393.7 mm (15.5 in.) in length <input type="checkbox"/> Business cards "Placing Standard Size Originals" on page 42 <input type="checkbox"/> Mixture of originals "Loading Batches of Originals with Different Paper Types and Sizes" on page 82 	<ul style="list-style-type: none"> <input type="checkbox"/> Large size originals "Placing Large Size Originals" on page 47 <input type="checkbox"/> Long paper <input type="checkbox"/> Receipts over 393.7 mm (15.5 in.) in length "Placing Long Paper" on page 51 <input type="checkbox"/> Plastic cards "Placing Plastic Cards" on page 55 <input type="checkbox"/> Laminated cards "Placing Laminated Cards" on page 59 <input type="checkbox"/> Booklets "Placing a Booklet" on page 62 <input type="checkbox"/> Passports "Placing a Passport" on page 65 <input type="checkbox"/> Photos (using a carrier sheet) <input type="checkbox"/> Important or essential originals (using a carrier sheet) "Placing Important Originals or Photos" on page 70 <input type="checkbox"/> Envelopes "Placing an Envelope" on page 74 <input type="checkbox"/> Irregular size originals (using a carrier sheet) "Placing Irregular Shaped Originals" on page 78

Related Information

➔ ["Position of Scanner" on page 20](#)

Placing Standard Size Originals

1. Make sure the scanner position light () is off.

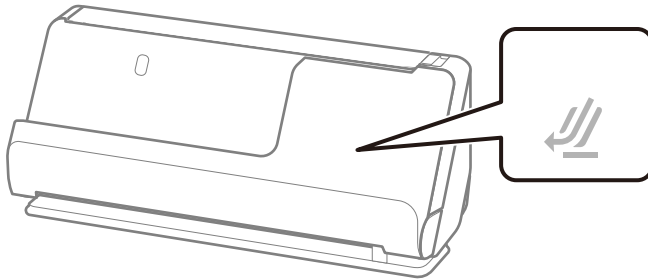

If the scanner position light () is on, pull the scanner position selector to tilt the scanner forward.

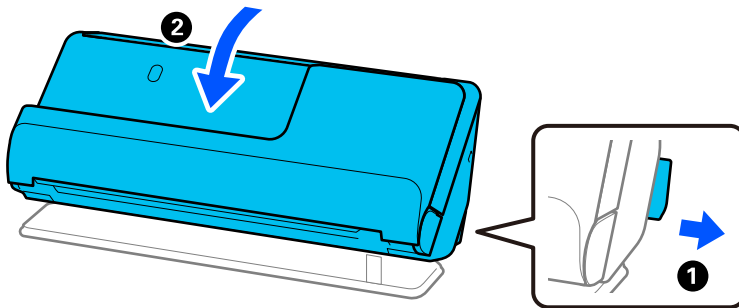

2. Open the input tray.

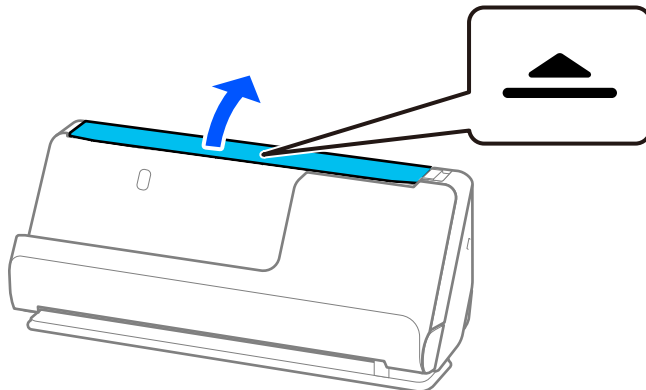

3. Raise the input tray extension.

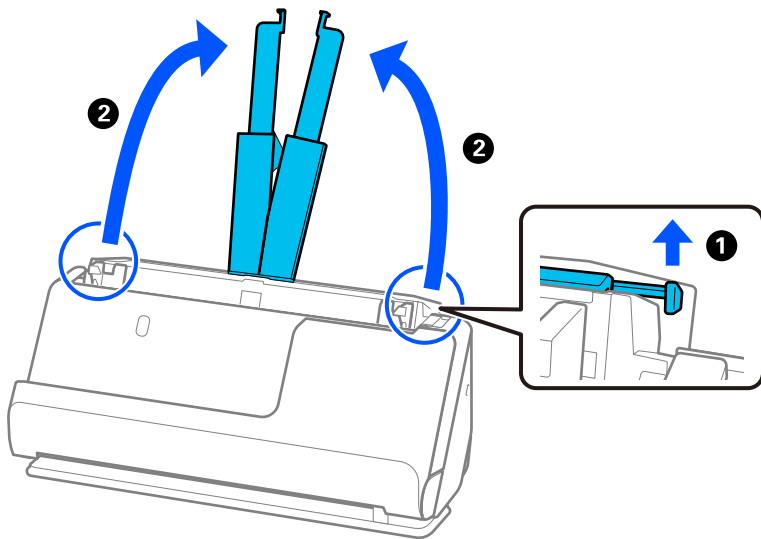

4. Move the edge guides to the edges of the input tray.

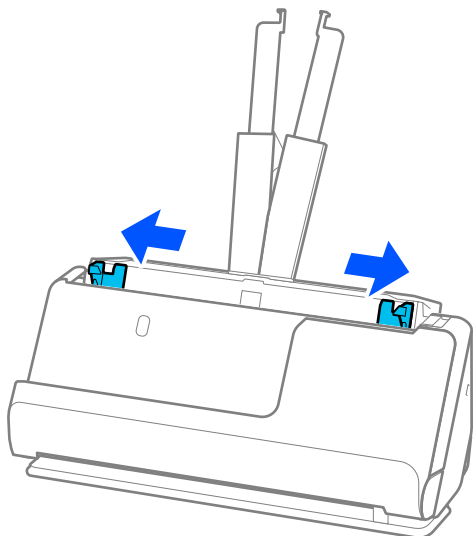

5. Fan the originals.
Hold both ends of the originals and fan them a few times.

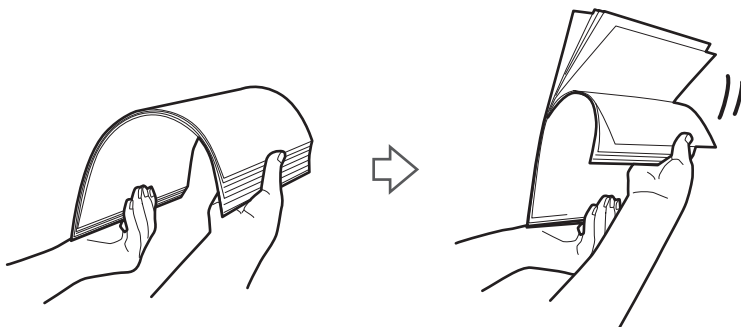

6. Align the edges of the originals, and with the side to be scanned facing up, slide the leading edges into a wedge shape.

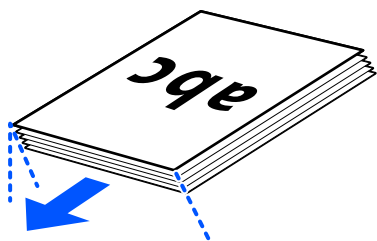

7. Place the originals into the ADF input tray facing up and with the top edge facing into the ADF. Insert the paper into the ADF until it meets resistance.

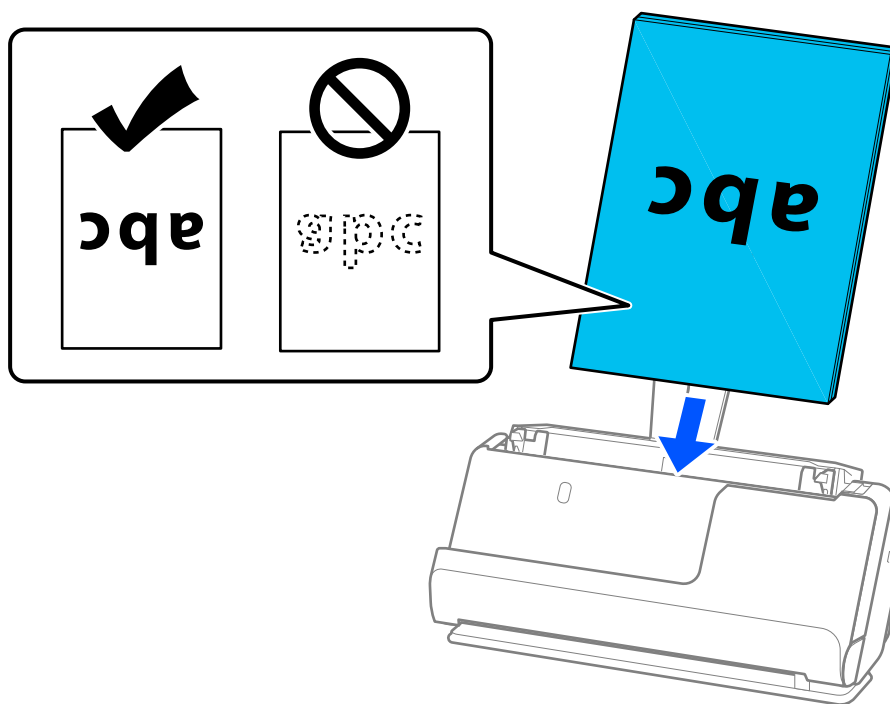

- ❑ When scanning originals with punch holes, such as loose leaf paper, load the originals with the holes facing to the left, right, or facing down. Place the originals so that there are no holes within a range of 15 mm (0.6 inches) to the left and right (30 mm (1.2 inches) in total) from the center of the originals. However, there can be holes within 30 mm (1.2 inches) from the leading edge of the originals. Make sure that the edges of the punch holes do not have burrs or curls.

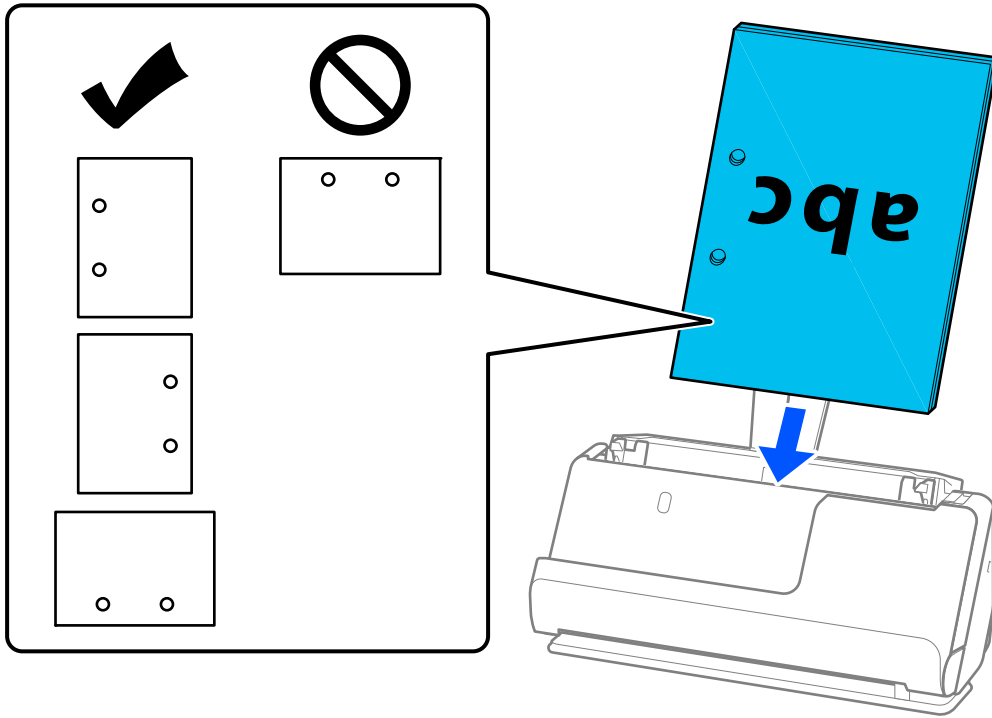

- ❑ Place folded originals so that the valley fold is at the front of the scanner and on the ADF side. You can load up to 10 sheets. Originals with a hard fold line may not be fed properly. For originals such as these, flatten them so that the height of the fold is 5 mm (0.2 inches) or less before loading it.

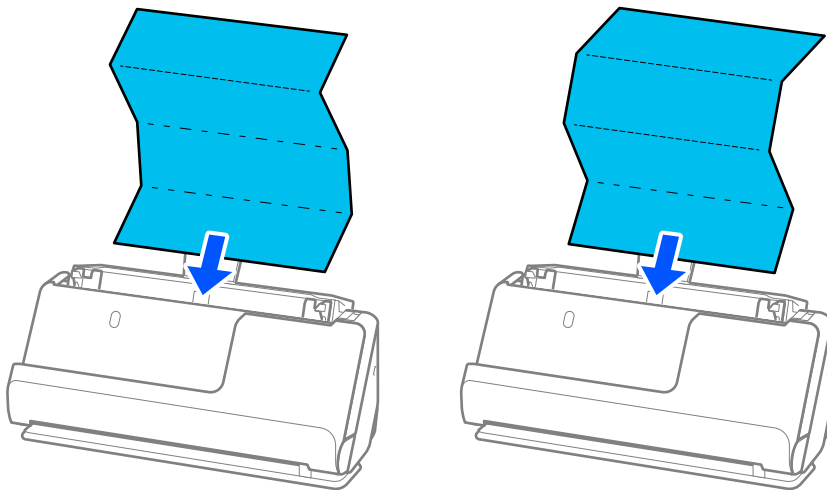

- ❑ When scanning award certificates and other thick originals (originals with a thickness of 127 g/m² or more), switch the scanner to the straight path position and load only one original at a time.

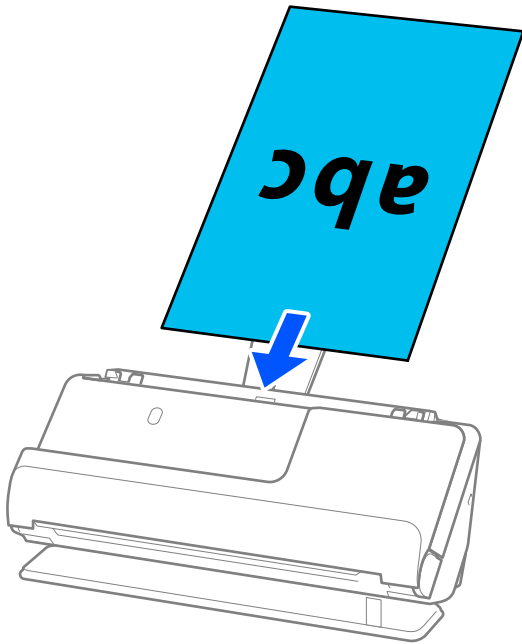

You can check the scanner position using the scanner position light () . When the scanner position light is on, the scanner is in the straight path position. If the scanner position light is off (in the vertical path position), pull the lever on the back to tilt the scanner back.

When scanning in the straight path position, make sure there is enough space in front of the scanner for the ejected originals.

Also, if the ejected originals hit the surface of the table on which the scanner is placed and this affects the scanned image, move the scanner to the edge of the table so that the ejected originals can drop and catch them directly.

8. Adjust the edge guides to fit the edges of the original so that there are no gaps. Otherwise, the original may be fed skewed.

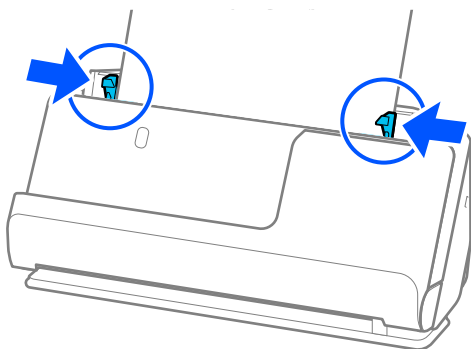

Note:

- ❑ If the edge guides are too far apart or too tight, the original may not be fed correctly. The edge guides should be aligned so that they lightly touch the edges of the original.
- ❑ If the document extends beyond the input tray extension, support the document with one hand to prevent it from falling from the ADF. Also, while scanning an original, support both ends of the original with your hands to prevent it from tilting.
- ❑ When scanning thin paper originals such as flyers or receipts, or when scanning originals that tend to curl after scanning, we recommend extending the paper output support in both places.

After loading the original, press the buttons (two places) to raise the paper output support.

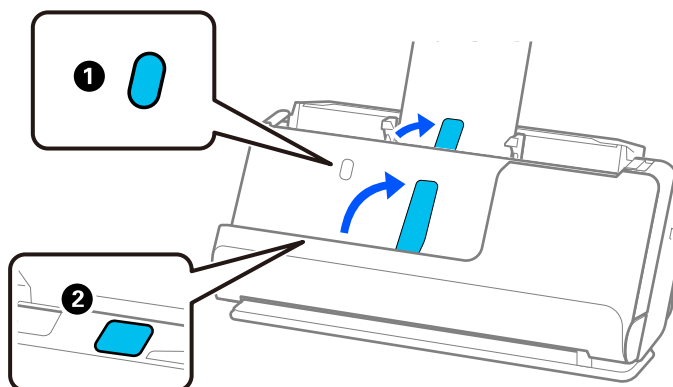

- ❑ When scanning originals such as business cards that tend to curl after scanning, we recommend scanning in the straight path position and only loading one original at a time.
- ❑ Epson Scan 2 allows you to preview the first side of your original. Load only the first original into the ADF, and then press the **Preview** button. The preview window opens, the previewed image is displayed, and the page is ejected from the scanner.
Replace the ejected page together with the rest of the originals.
- ❑ When loading and previewing multiple originals at once, or if you cancel scanning in the middle of scanning a batch of originals, the second original will be fed a little bit into the ADF and then scanning stops. Open the scanner cover to remove it, and then load the page again together with the first page and the rest of the originals.
- ❑ Depending on the type of paper and the environment in which the scanner is being used, the original may fall from the front of the scanner after scanning. In this situation, load fewer originals into the scanner than the specified number of originals that can be loaded.

Placing Large Size Originals

Note:

- ❑ Use a Carrier Sheet when scanning wrinkled, fragile, or valuable originals.
[“Placing Important Originals or Photos” on page 70](#)
- ❑ Make sure there is enough space in front of the scanner for the ejected originals.

1. Make sure the scanner position light () is on.

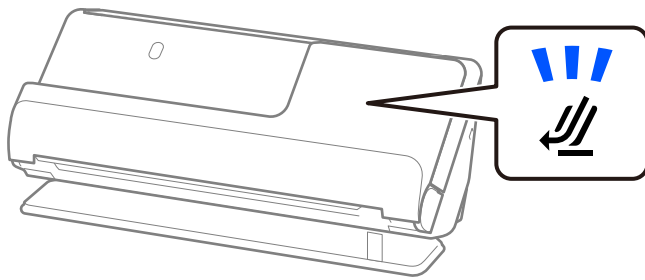

If the scanner position light () is off, pull the scanner position selector to tilt the scanner back.

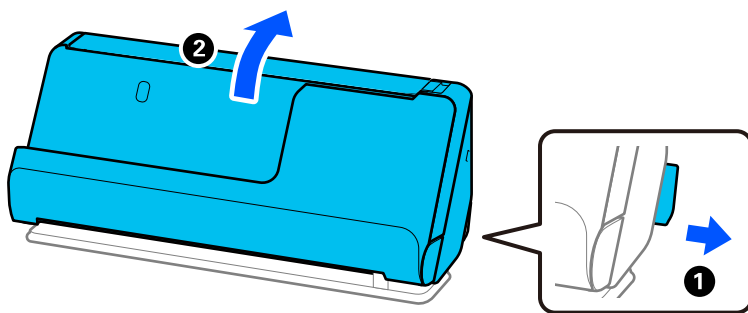

2. Open the input tray.

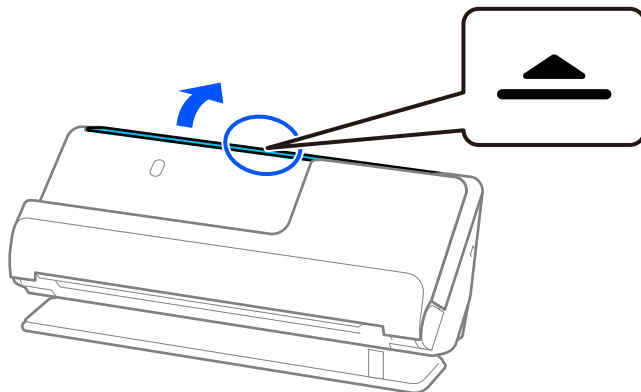

3. Raise the input tray extension.

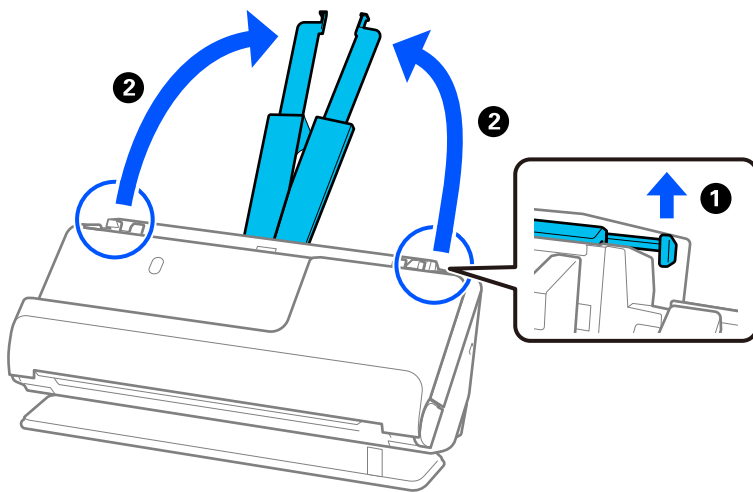

4. Move the edge guides to the edges of the input tray.

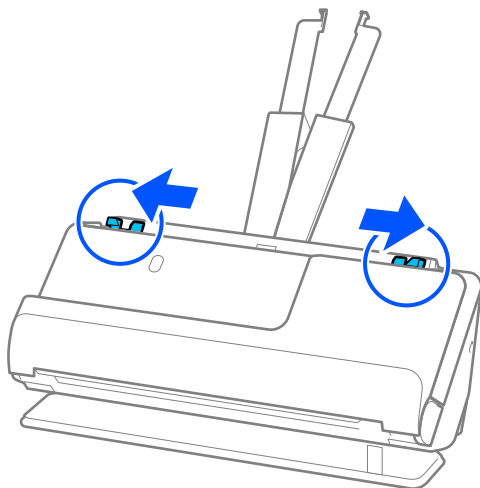

5. Fold the original in half so that the side to be scanned is facing out.

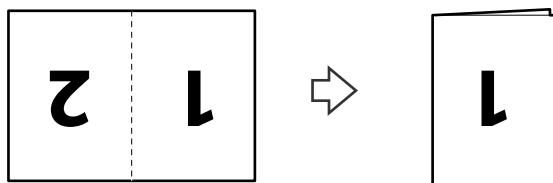

- Place the original with side “1” facing up and the leading edge facing into the ADF. Insert the paper into the ADF until it meets resistance.

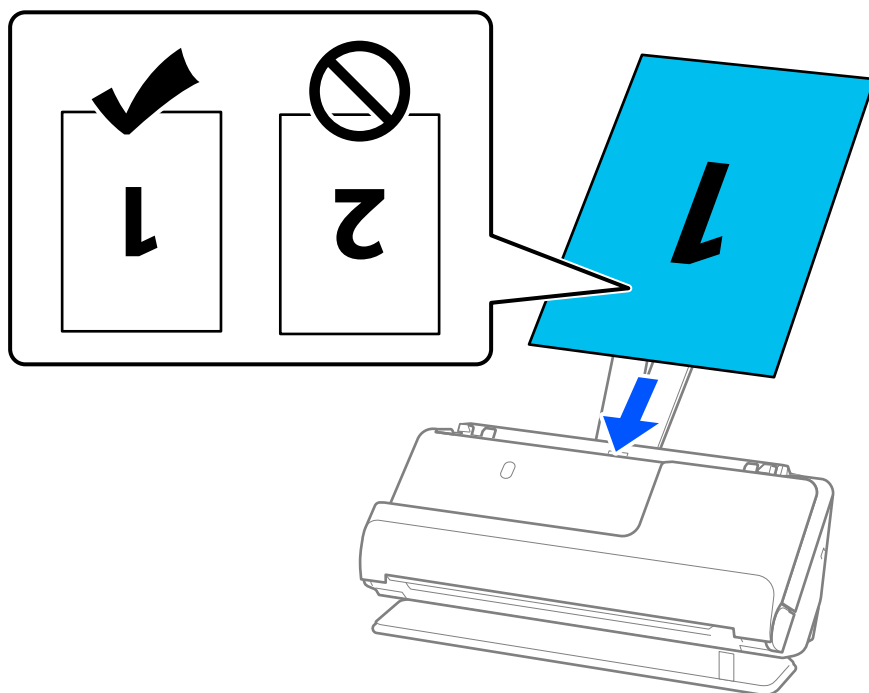

- Adjust the edge guides to fit the edges of the original so that there are no gaps. Otherwise, the original may be fed skewed.

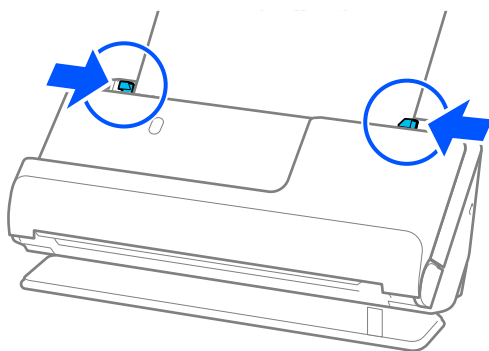

Note:

- If the edge guides are too far apart or too tight, the original may not be fed correctly. The edge guides should be aligned so that they lightly touch the edges of the original.
- To scan both sizes and stitch them together, set the appropriate setting in the Epson Scan 2 window.

When you are using Document Capture Pro, you can open the window by pressing the **Detailed Settings** button on the **Scan Settings** screen.

Select **Double-Sided** from **Scanning Side** and select **Left & Right** from **Stitch Images** in the Epson Scan 2 window. See the Epson Scan 2 help for details.

Related Information

- ➔ [“Carrier Sheet Codes” on page 26](#)
- ➔ [“Software Settings Required for Special Originals” on page 103](#)

Placing Long Paper

Note:

Make sure there is enough space in front of the scanner for the ejected originals.

1. Make sure the scanner position light () is on.

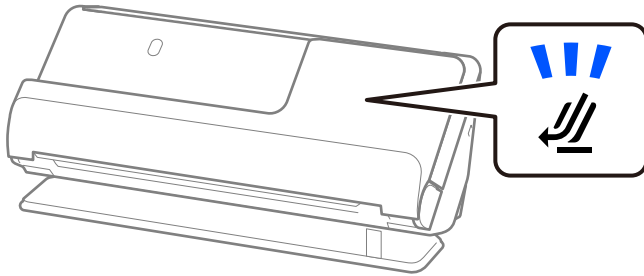

If the scanner position light () is off, pull the scanner position selector to tilt the scanner back.

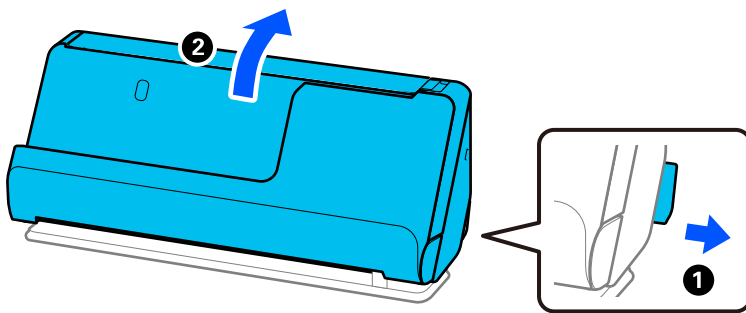

2. Open the input tray.

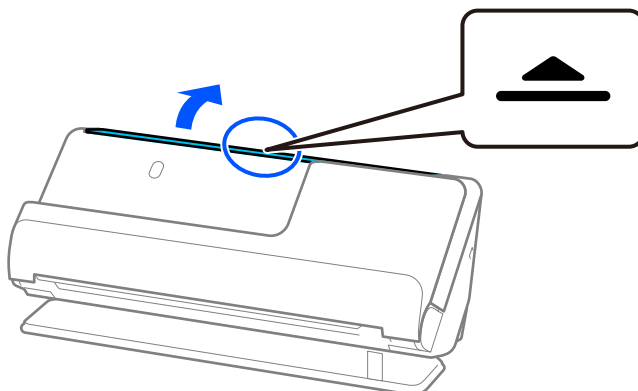

3. Raise the input tray extension.

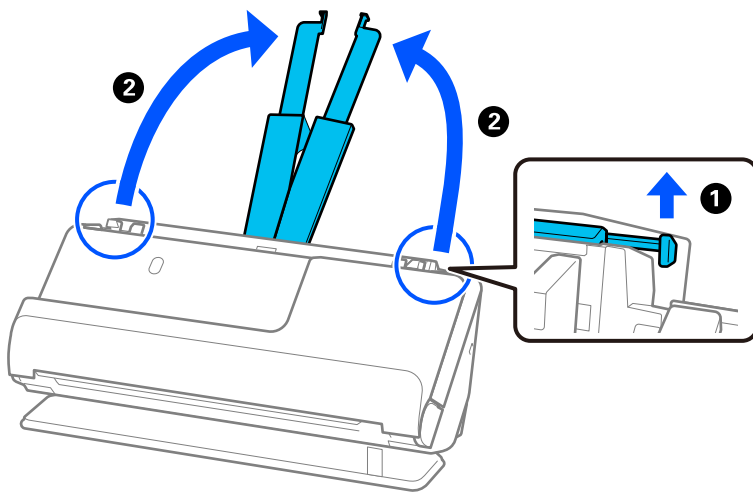

4. Move the edge guides to the edges of the input tray.

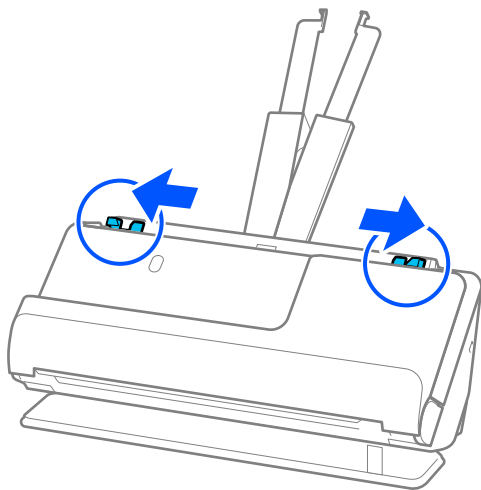

5. Load the original into the input tray straight, facing up and with the top edge facing into the ADF. Insert the paper into the ADF until it meets resistance.

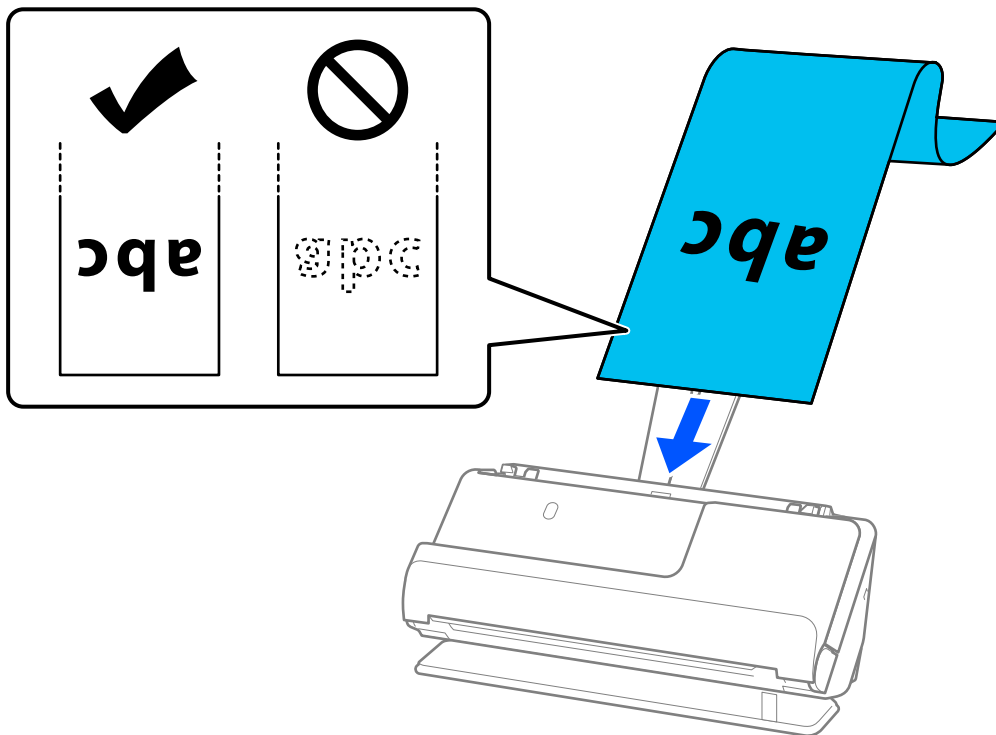

When loading long paper, support it at the input side so that it does not drop out of the ADF, and the output side so that the ejected paper does not get jammed or fall from the output tray.

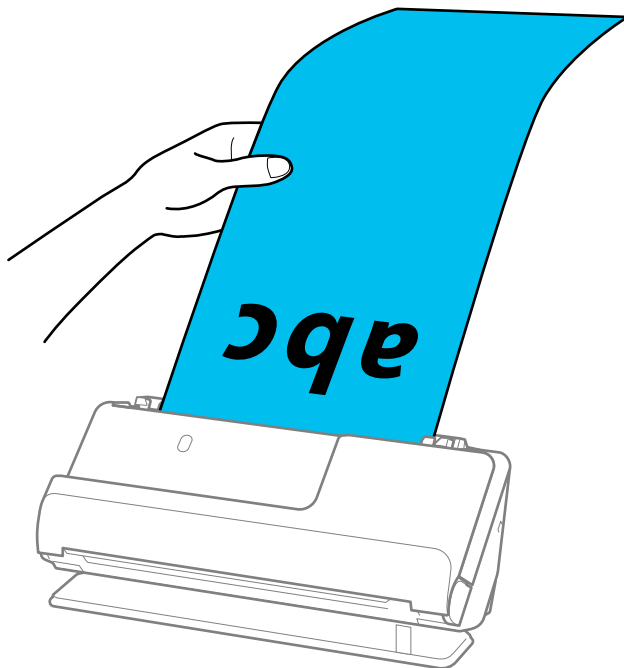

6. Adjust the edge guides to fit the edges of the original so that there are no gaps. If there are any gaps, the original may be fed skewed.

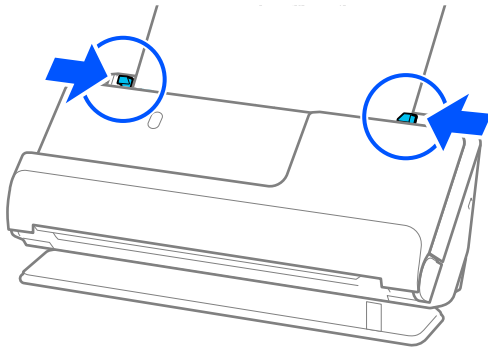

Note:

- ❑ If the edge guides are too far apart or too tight, the original may not be fed correctly. The edge guides should be aligned so that they lightly touch the edges of the original.
- ❑ Also, while scanning long paper, support both ends of the original with your hands to prevent it from tilting.

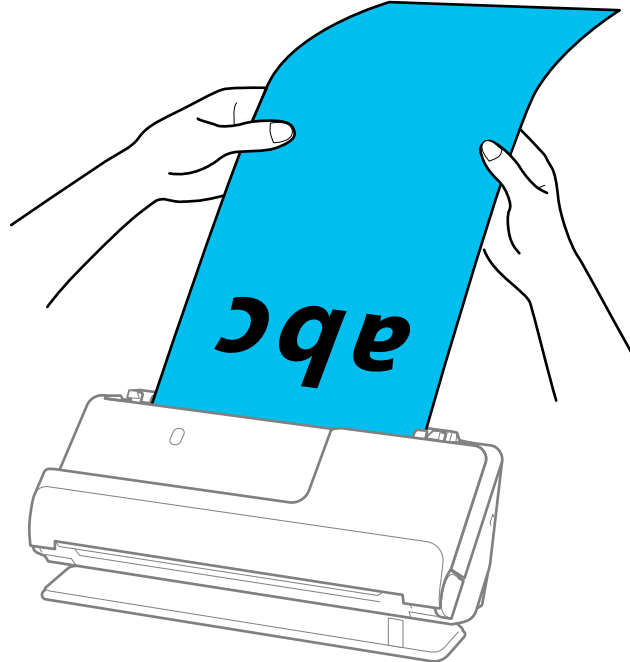

- ❑ You can scan long paper at the following resolutions.

- Up to 1,346.0 mm: 600 dpi or less
- 1,346.0 to 5,461.0 mm: 300 dpi or less
- 5,461.0 to 5,588.0 mm: 200 dpi or less

- ❑ You need to specify the paper size in the Epson Scan 2 window.

When you are using Document Capture Pro, you can open the window by pressing the **Detailed Settings** button on the **Scan Settings** screen.

There are three ways to specify the paper size in the Epson Scan 2 window.

If the paper length is 3,048.0 mm (120 inches) or less, you can select **Auto Detect (Long Paper)** to detect the size automatically.

If the paper length is more than 3,048.0 mm (120 inches), you need to select **Customize** and enter the size of the paper. If the paper length is 5,461.0 mm (215 inches) or less, you can use **Detect paper length** instead of entering the paper height. If the paper is longer than 5,461.0 mm (215 inches), you need to enter the width and height of the paper.

Related Information

➔ [“Software Settings Required for Special Originals” on page 103](#)

Placing Plastic Cards

Note:

Make sure there is enough space in front of the scanner for the ejected originals.

1. Make sure the scanner position light () is on.

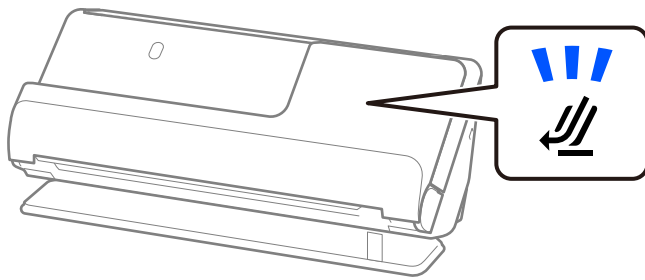

If the scanner position light () is off, pull the scanner position selector to tilt the scanner back.

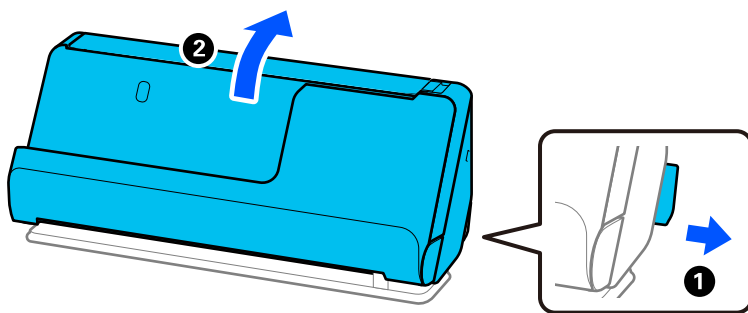

2. Open the input tray.

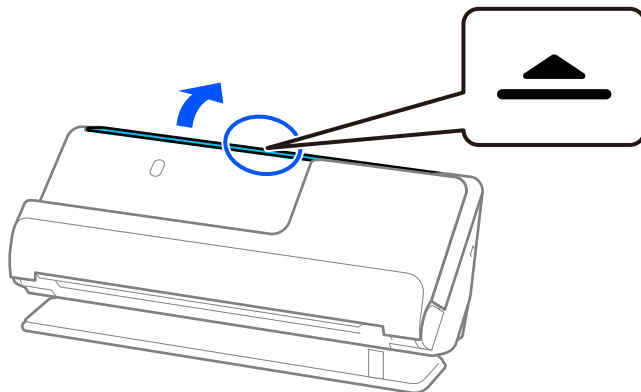

3. Raise the input tray extension.

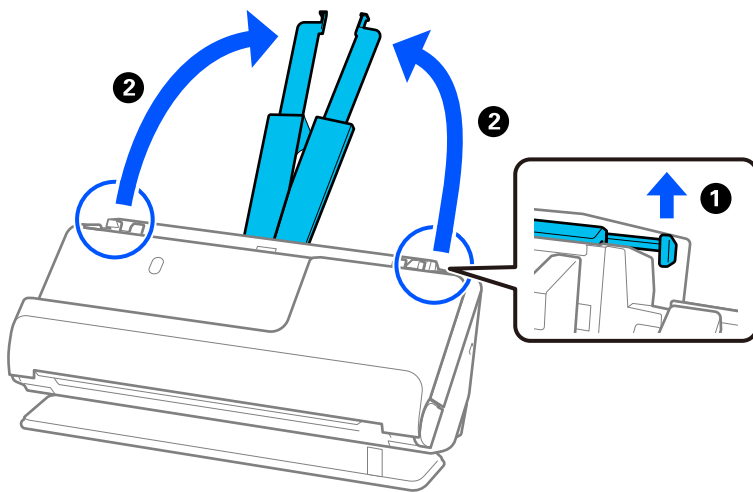

4. Move the edge guides to the edges of the input tray.

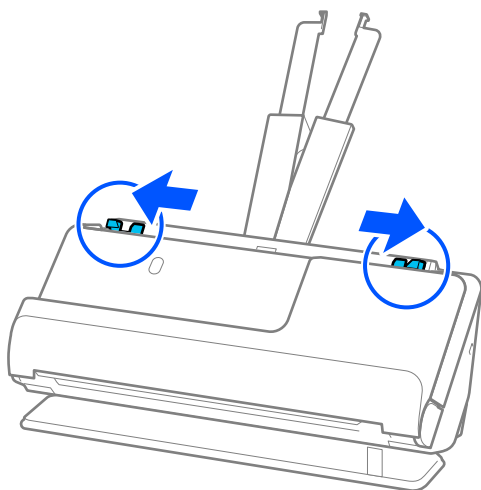

5. Load the plastic cards with the side to be scanned facing up with the top edge facing into the ADF. Insert the paper into the ADF until it meets resistance.

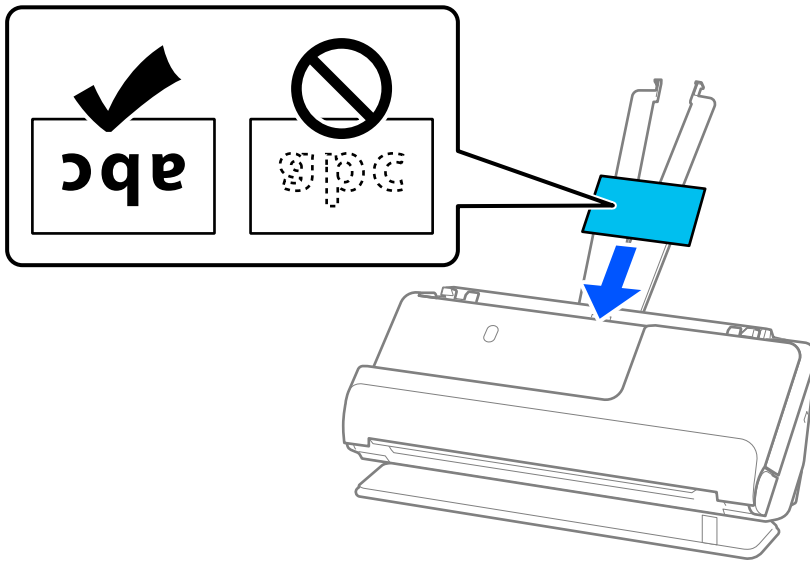

! *Important:*

Do not load plastic cards vertically.

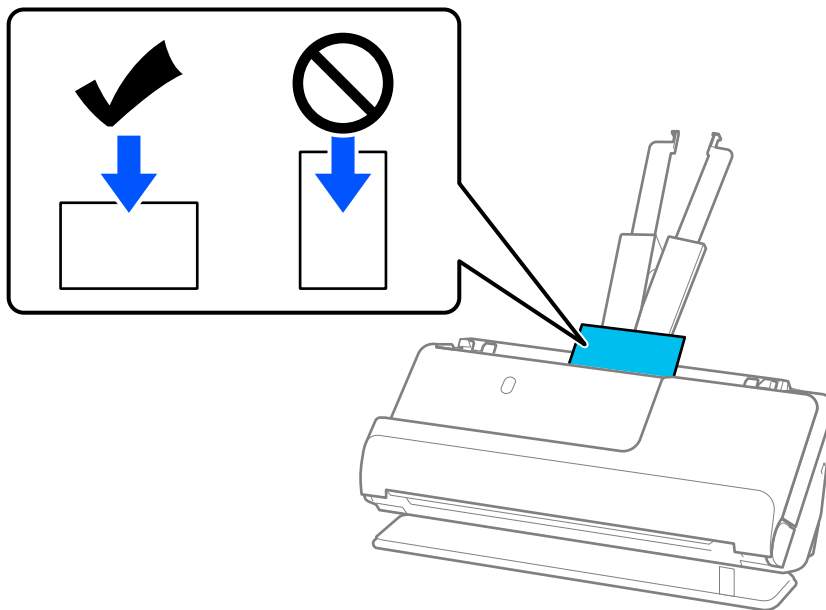

- Adjust the edge guides to fit the edges of the cards so that there are no gaps. Otherwise, the original may be fed skewed.

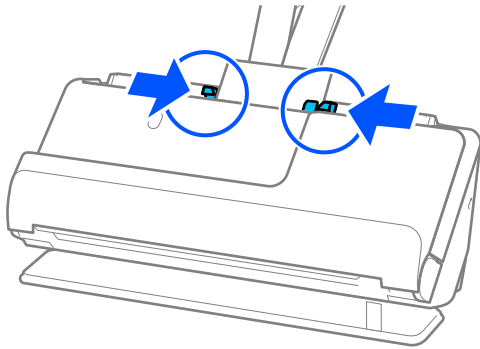

Note:

- If the edge guides are too far apart or too tight, the original may not be fed correctly. The edge guides should be aligned so that they lightly touch the edges of the original.
- To scan plastic cards, set the appropriate setting in the Epson Scan 2 window.
When you are using Document Capture Pro, you can open the Epson Scan 2 screen by pressing the **Detailed Settings** button on the **Scan Settings** screen.
On the **Main Settings** tab in Epson Scan 2, select **Plastic Card** in **Document Size** or select **Off** in **Detect Double Feed**. See the Epson Scan 2 help for details.
If you have not disabled **Detect Double Feed** on the Epson Scan 2 screen and a double feed error occurs, remove the cards from the ADF and reload them.

Related Information

- ➔ [“Placing Laminated Cards” on page 59](#)
- ➔ [“Software Settings Required for Special Originals” on page 103](#)

Placing Laminated Cards

Note:

Make sure there is enough space in front of the scanner for the ejected originals.

- Make sure the scanner position light () is on.

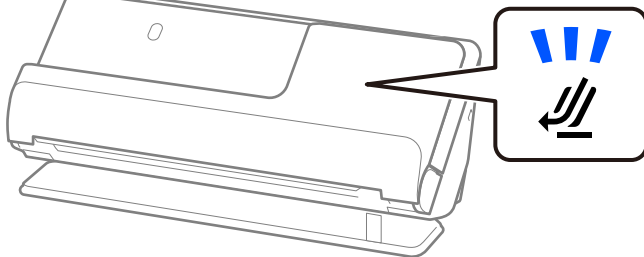

If the scanner position light () is off, pull the scanner position selector to tilt the scanner back.

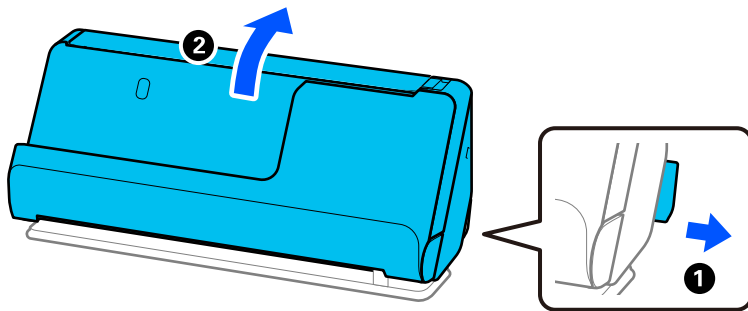

2. Open the input tray.

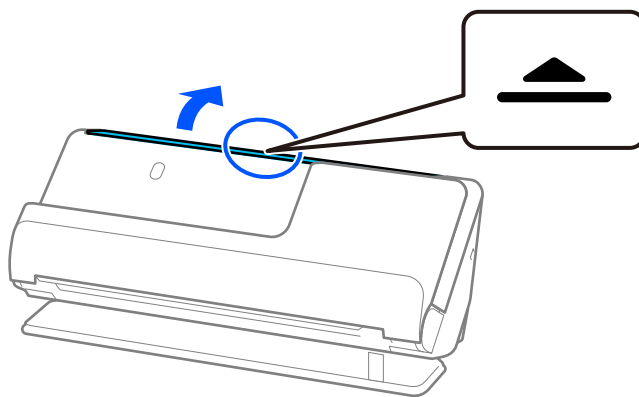

3. Raise the input tray extension.

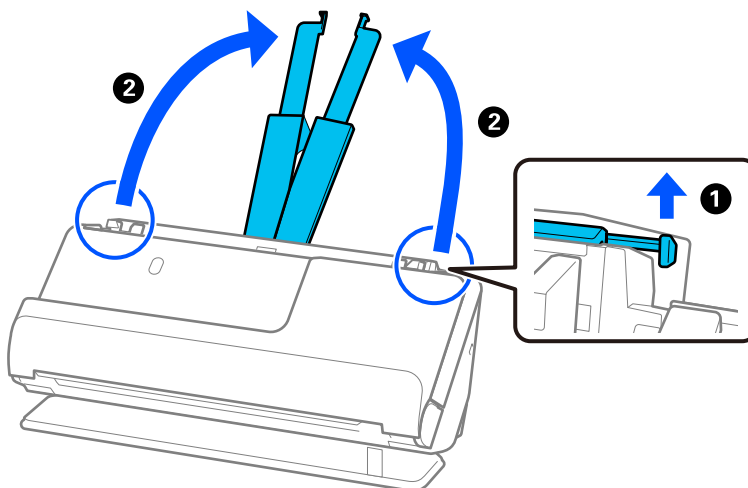

4. Move the edge guides to the edges of the input tray.

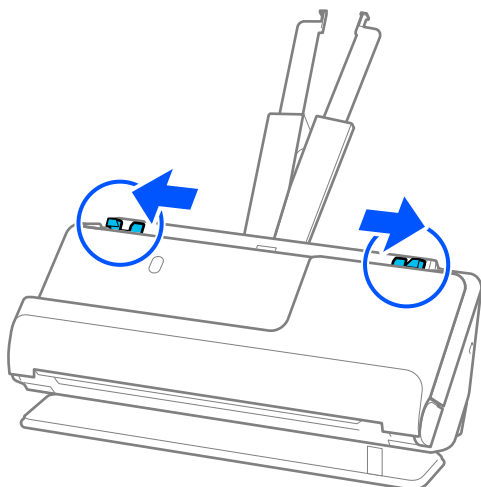

5. Load the plastic cards with the side to be scanned facing up with the top edge facing into the ADF. Insert the paper into the ADF until it meets resistance.

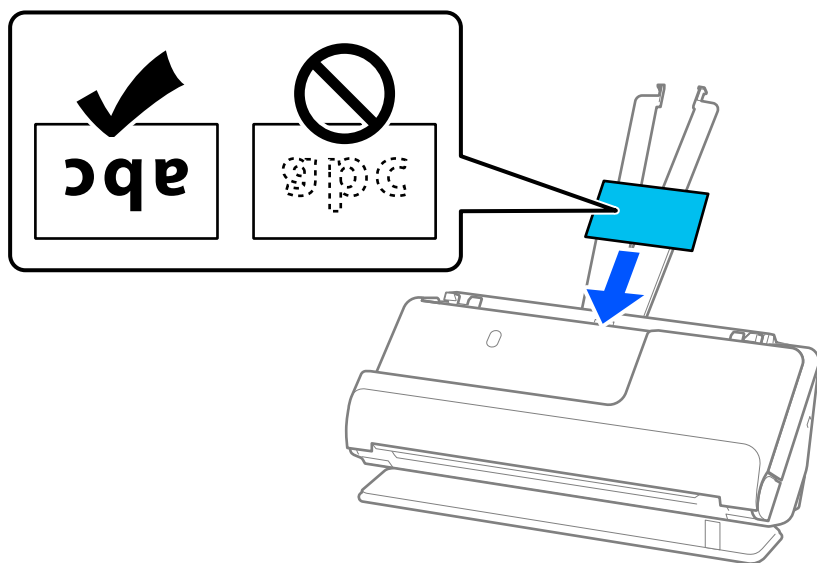

6. Adjust the edge guides to fit the edges of the cards so that there are no gaps. If there are any gaps, the original may be fed skewed.

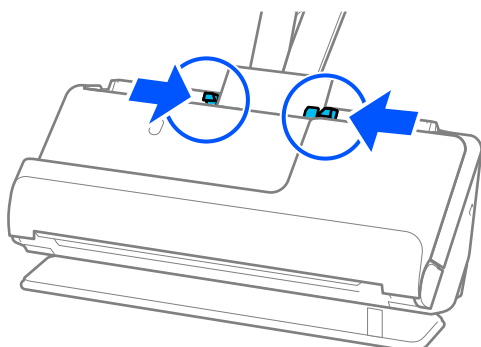

Note:

- ❑ If the edge guides are too far apart or too tight, the original may not be fed correctly. The edge guides should be aligned so that they lightly touch the edges of the original.
- ❑ To scan laminated cards, set the appropriate setting in the Epson Scan 2 window.

When you are using Document Capture Pro, you can open the window by pressing the **Detailed Settings** button on the **Scan Settings** screen.

· To increase the accuracy of auto size detection, select the **Main Settings** tab > **Document Size** > **Settings** > **Scan laminated card**. See the Epson Scan 2 help for details.

· Select the **Main Settings** tab > **Detect Double Feed** > **Off**. See the Epson Scan 2 help for details.

If you have not disabled **Detect Double Feed** on the Epson Scan 2 screen and a double feed error occurs, remove the cards from the ADF and reload them.

Related Information

➔ [“Software Settings Required for Special Originals” on page 103](#)

Placing a Booklet

Note:

Make sure there is enough space in front of the scanner for the ejected originals.

1. Make sure the scanner position light () is on.

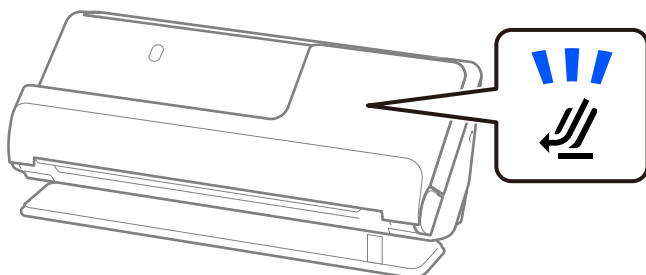

If the scanner position light () is off, pull the scanner position selector to tilt the scanner back.

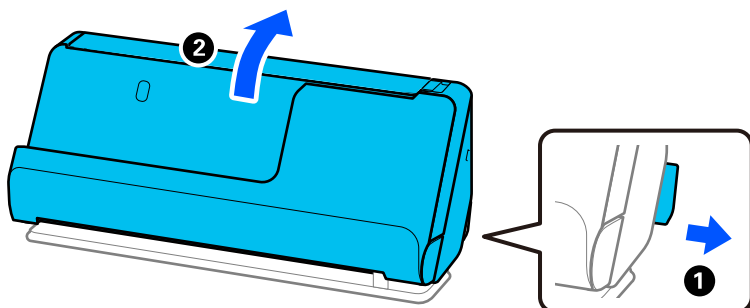

2. Open the input tray.

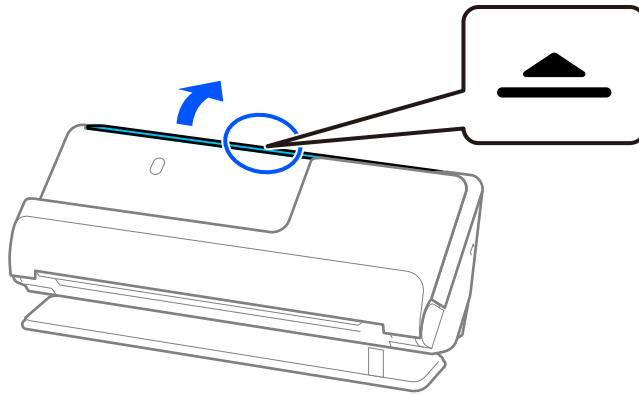

3. Raise the input tray extension.

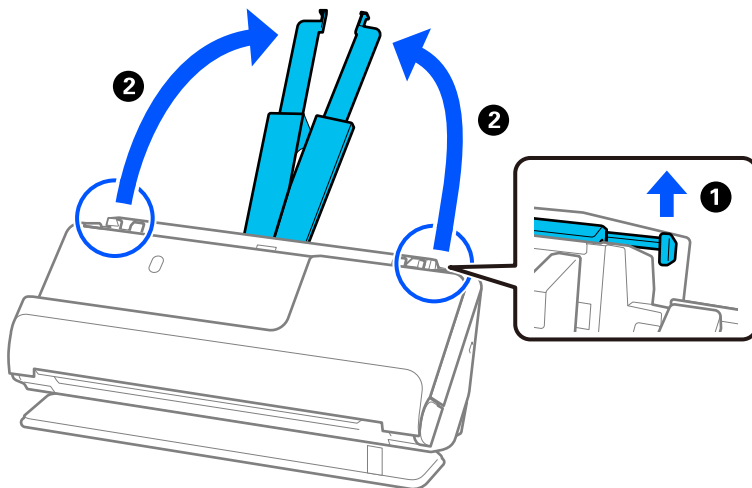

4. Move the edge guides to the edges of the input tray.

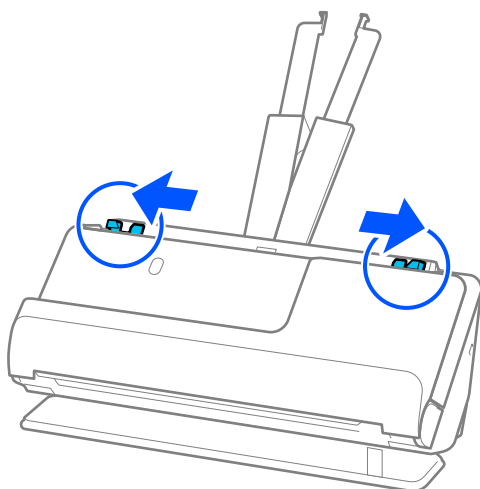

5. Place the booklet with the side to be scanned facing up and with the side with more pages facing the ADF. Insert the paper into the ADF until it meets resistance.

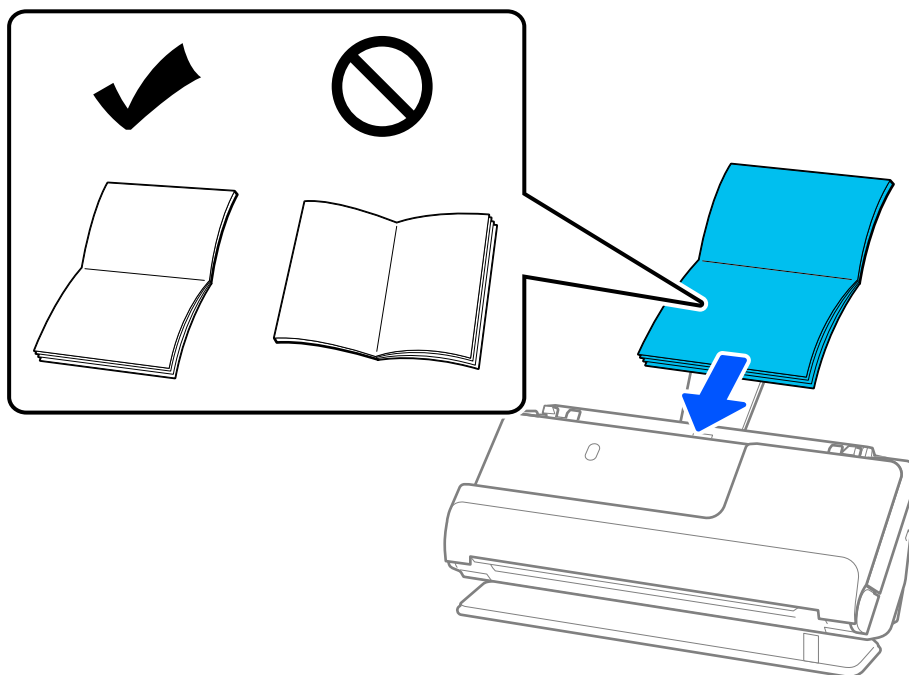

6. Adjust the edge guides to fit the edges of the booklet so that there are no gaps. If there are any gaps, the original may be fed skewed.

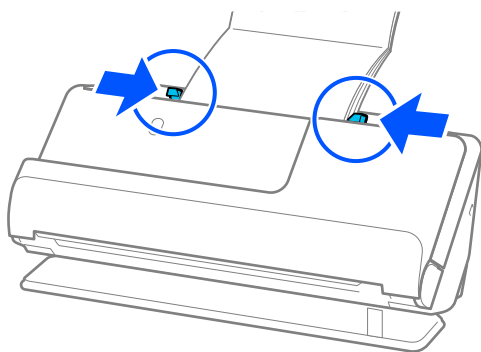

Note:

- ❑ If the edge guides are too far apart or too tight, the original may not be fed correctly. The edge guides should be aligned so that they lightly touch the edges of the original.
- ❑ When scanning booklets, support the top of the booklet by hand to prevent it from falling out of the ADF or closing.

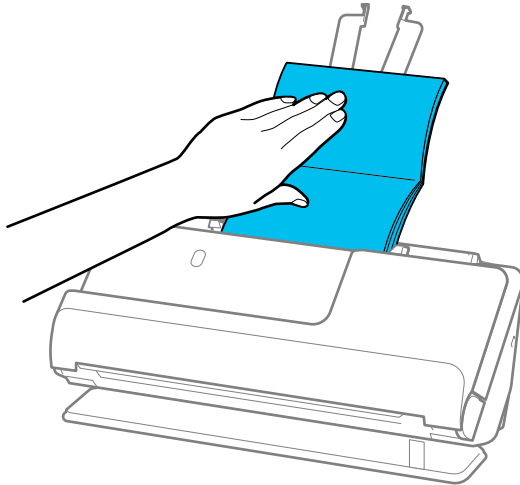

- ❑ If the ejected originals hit the surface of the table on which the scanner is placed and this affects the scanned image, move the scanner to the edge of the table so that the ejected originals can drop and catch them directly.
- ❑ When scanning booklets, make the appropriate settings on the Epson Scan 2 screen.
When you are using Document Capture Pro, you can open the window by pressing the **Detailed Settings** button on the **Scan Settings** screen.
On the Epson Scan 2 screen, use one of the following methods to turn off **Detect Double Feed**.
 - Select **Booklets** in **Scan Settings**
 - On the **Main Settings** tab, set **Detect Double Feed** to **Off**See the Epson Scan 2 help for details.

Related Information

➔ [“Software Settings Required for Special Originals” on page 103](#)

Placing a Passport

Note:

Make sure there is enough space in front of the scanner for the ejected originals.

1. Make sure the scanner position light () is on.

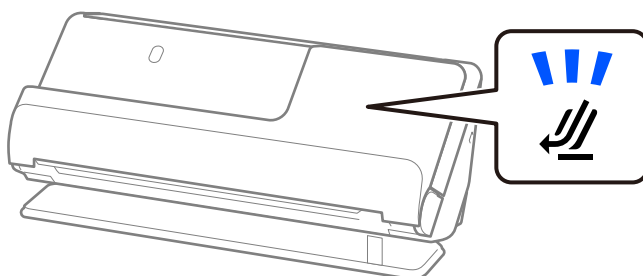

If the scanner position light () is off, pull the scanner position selector to tilt the scanner back.

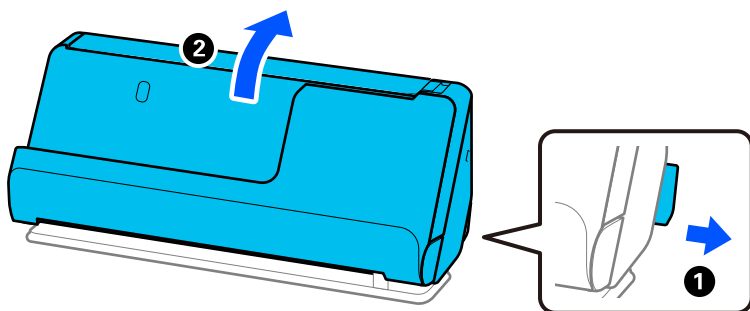

2. Open the input tray.

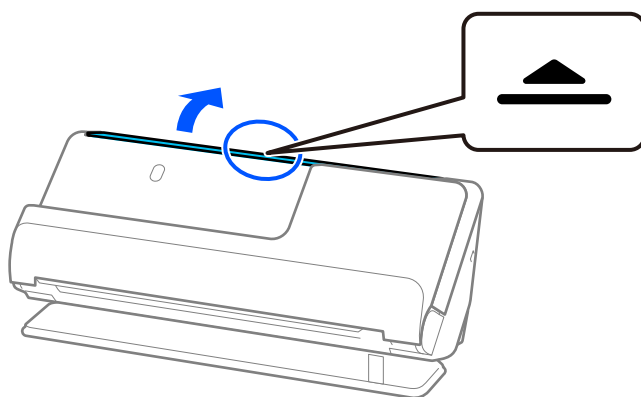

3. Raise the input tray extension.

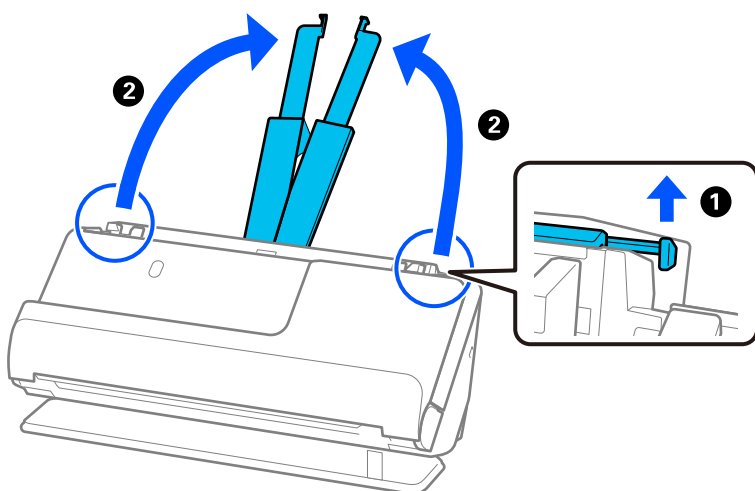

4. Move the edge guides to the edges of the input tray.

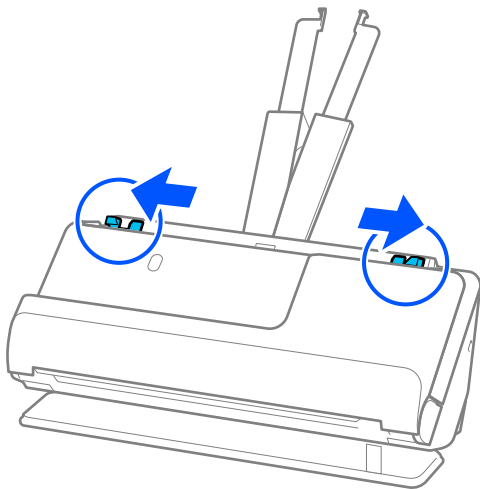

5. Place the passport with the side to be scanned facing up and with thicker side of the passport facing into the ADF.

Insert the paper into the ADF until it meets resistance.

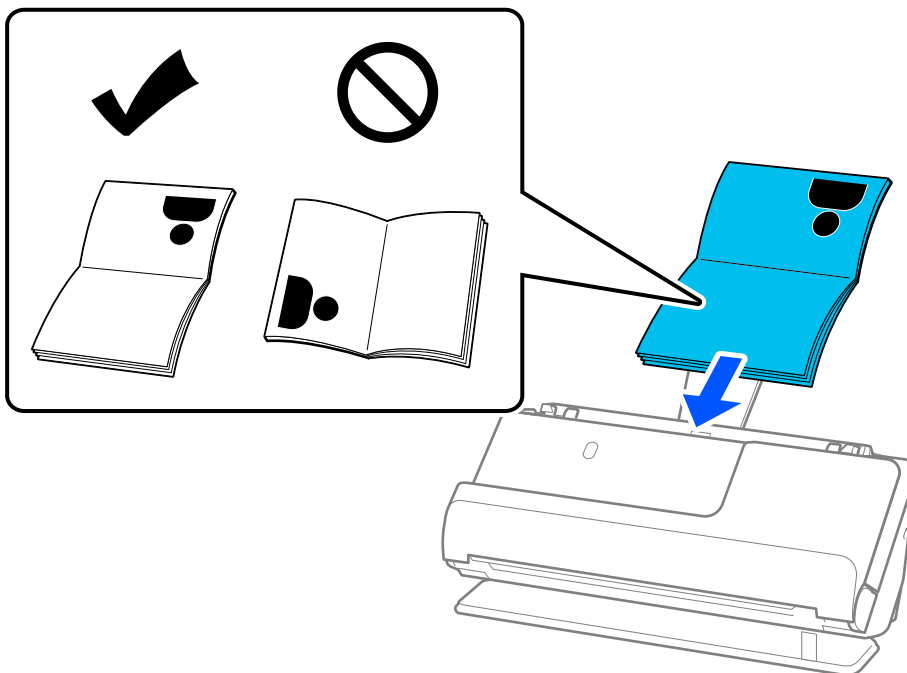

Note:

In the following cases, scan the passport using the Passport Carrier Sheet instead.

- ❑ *If you want to protect the passport while scanning*
- ❑ *If you want to scan thick passports and passports with a slightly expanded binding edge*

Place the passport in the Passport Carrier Sheet with the side to be scanned facing up and with the thicker side of the passport facing the leading edge. Next, place the Passport Carrier Sheet into the input tray with the top edge facing into the ADF.

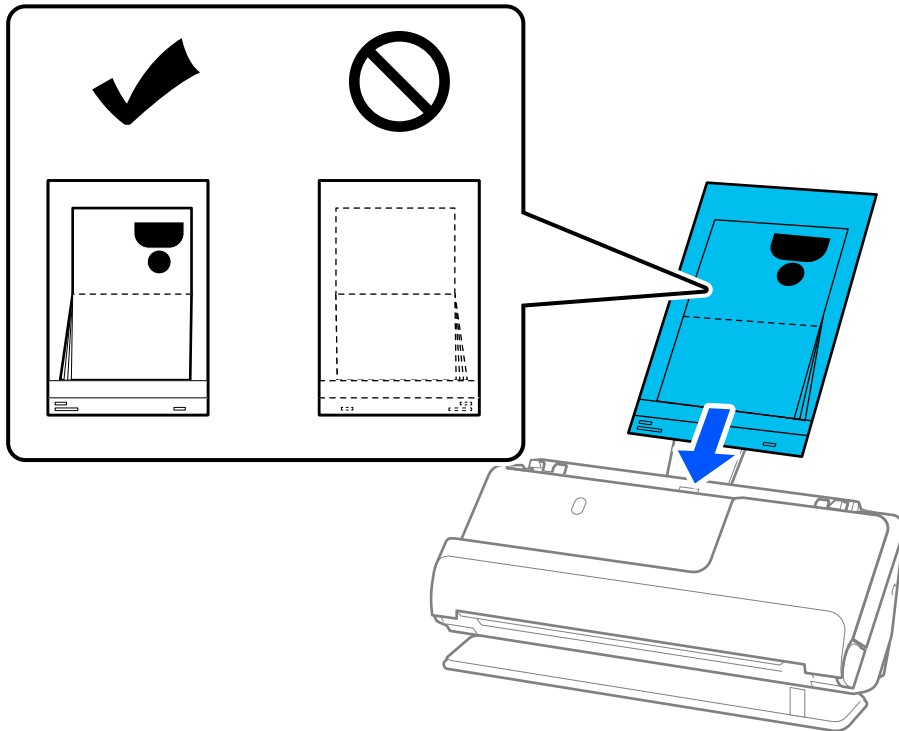

6. Adjust the edge guides to fit the edges of the original so that there are no gaps. If there are any gaps, the original may be fed skewed.

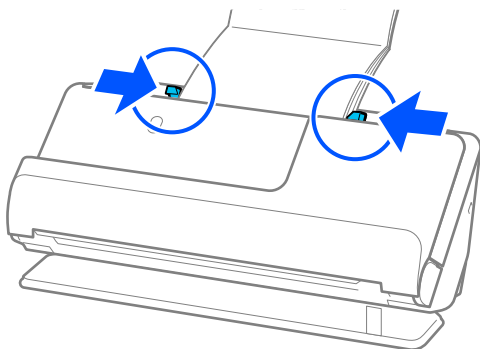

Note:

- ❑ If the edge guides are too far apart or too tight, the original may not be fed correctly. The edge guides should be aligned so that they lightly touch the edges of the original.
- ❑ When scanning passports, support the top of the passport by hand to prevent it from falling out of the ADF or closing.

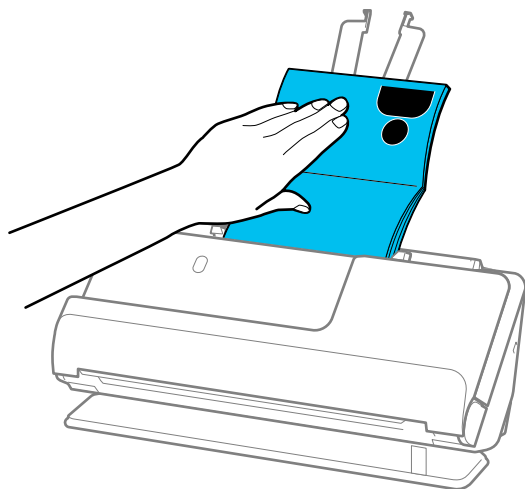

- ❑ If the ejected originals hit the surface of the table on which the scanner is placed and this affects the scanned image, move the scanner to the edge of the table so that the ejected originals can drop and catch them directly.
- ❑ When scanning a passport, make the appropriate settings on the Epson Scan 2 screen.
When you are using Document Capture Pro, you can open the window by pressing the **Detailed Settings** button on the **Scan Settings** screen.
On the Epson Scan 2 screen, use one of the following methods to turn off **Detect Double Feed**.
 - Select **Passport** in **Scan Settings**
 - On the **Main Settings** tab, set **Detect Double Feed** to **Off**See the Epson Scan 2 help for details.
- ❑ Do not use a scratched Passport Carrier Sheet or a Passport Carrier Sheet that has been scanned more than 3,000 times.
- ❑ Only use a Passport Carrier Sheet designed for your scanner. The Passport Carrier Sheet is automatically recognized by the scanner by detecting three small rectangular holes on the leading edge. Keep the holes in the Passport Carrier Sheet clean and uncovered.

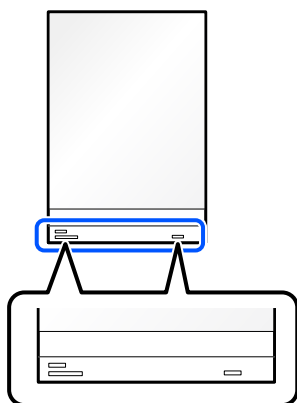

Related Information

- ➔ “Carrier Sheet Codes” on page 26
- ➔ “Software Settings Required for Special Originals” on page 103

Placing Important Originals or Photos

Use a Carrier Sheet when scanning the following types of originals.

- Photos
- Valuable originals
- Wrinkled originals
- Fragile originals

Note:

Make sure there is enough space in front of the scanner for the ejected originals.

1. Make sure the scanner position light () is on.

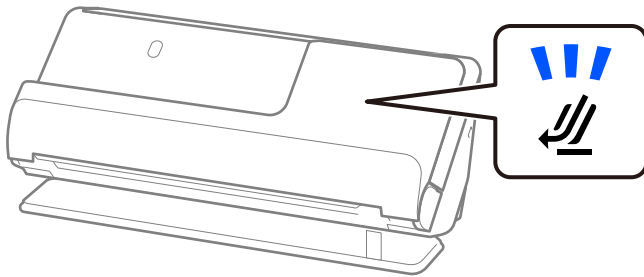

If the scanner position light () is off, pull the scanner position selector to tilt the scanner back.

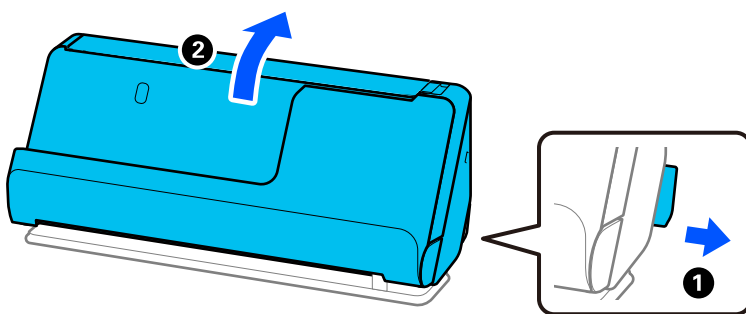

2. Open the input tray.

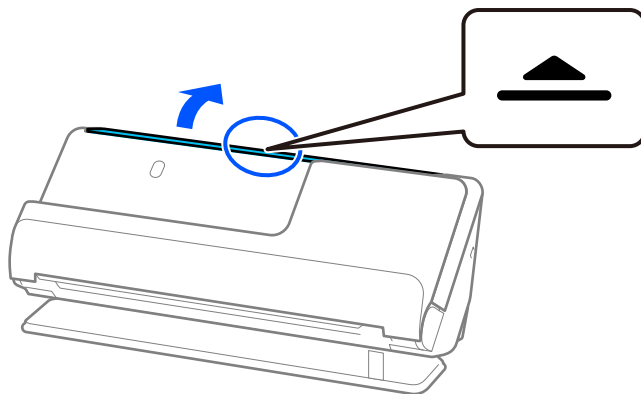

3. Raise the input tray extension.

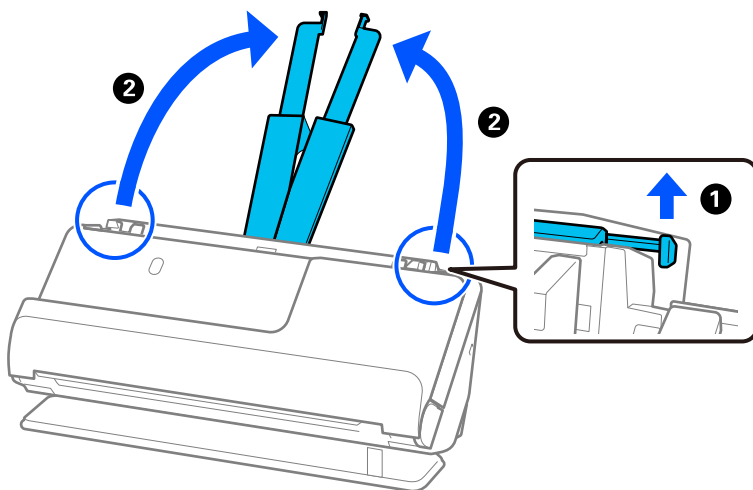

4. Move the edge guides to the edges of the input tray.

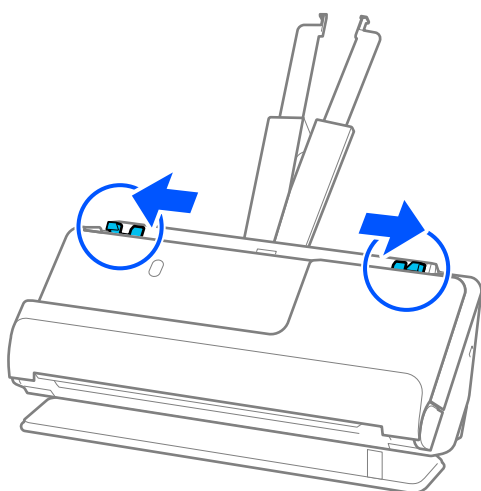

5. Place your original in the Carrier Sheet.

Place your original so that the back of the original is facing the side of the Carrier Sheet with the illustration.

❑ For originals

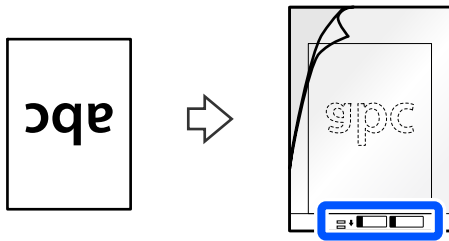

❑ For photos

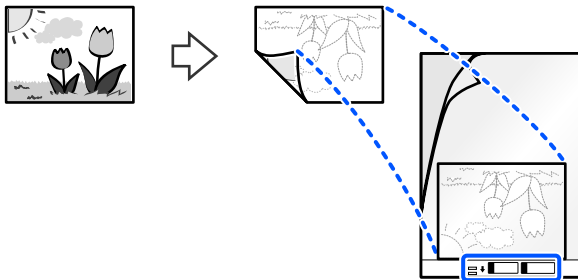

For large originals, fold them in half so that the side to be scanned is facing out, and then place the original with side "2" facing the side with the illustration and at the leading edge of the Carrier Sheet.

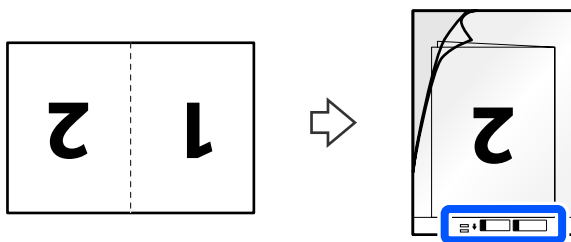

6. Turn over the Carrier Sheet.

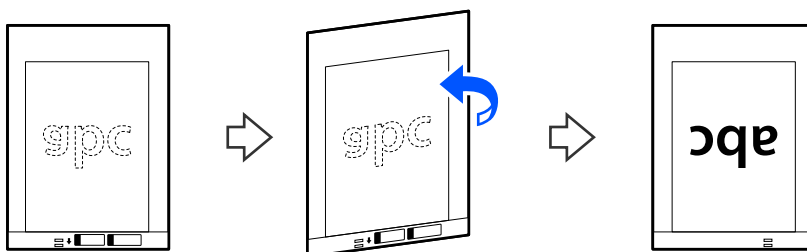

7. Load the Carrier Sheet into the input tray with the top edge facing into the ADF. Insert the paper into the ADF until it meets resistance.

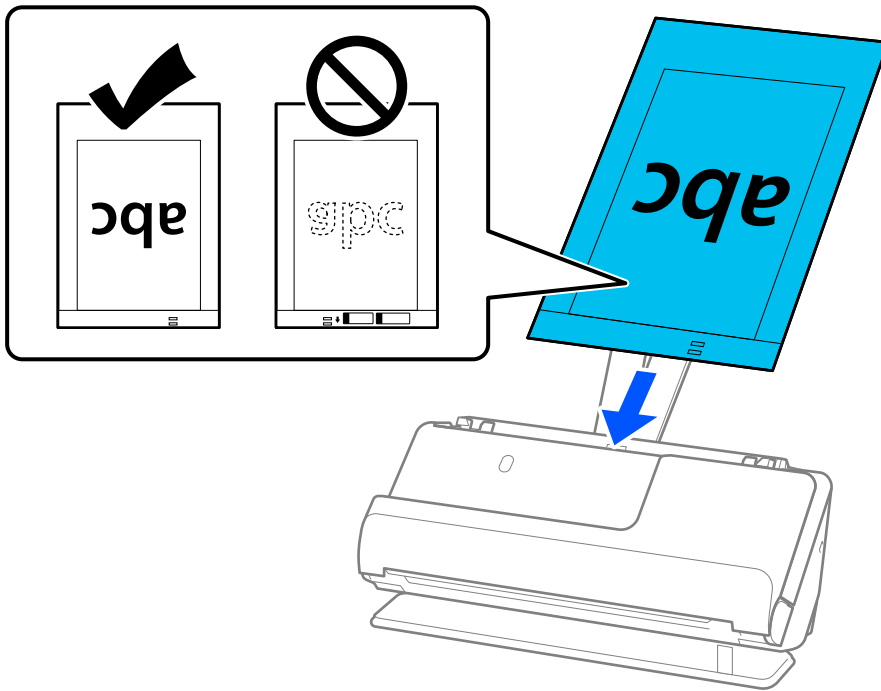

8. Align the edge guides with the Carrier Sheet so that there are no gaps. Otherwise, the Carrier Sheet may be fed skewed.

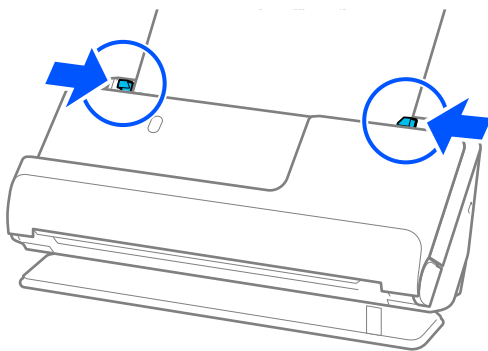

Note:

- ❑ If the edge guides are too far apart or too tight, the original may not be fed correctly. The edge guides should be aligned so that they lightly touch the edges of the original.
- ❑ Do not use a scratched Carrier Sheet or a Carrier Sheet that has been scanned more than 3,000 times.
- ❑ If you cannot find the size of the original to be scanned in the **Document Size** list in Epson Scan 2, select **Auto Detect**.

When using Epson Scan 2, you can also specify the size of the original in **Customize**.

- ❑ When scanning with a Carrier Sheet, select **Auto Detect** as the **Document Size** setting in Epson Scan 2 to automatically scan the image while applying **Paper Skew** as the **Correct Document Skew** setting.
- ❑ The leading edge of the original must be placed at the binding part of the Carrier Sheet when scanning an original approximately 297 mm (11.7 inches) long. Otherwise, the length of the scanned image may be longer than intended as the scanner scans to the end of the Carrier Sheet when you select **Auto Detect** as the **Document Size** setting in the Epson Scan 2 window.
- ❑ When scanning a large original, to scan both sizes and stitch them together, make the appropriate settings on the Epson Scan 2 screen.

When you are using Document Capture Pro, you can open the window by pressing the **Detailed Settings** button on the **Scan Settings** screen.

Select **Double-Sided** from **Scanning Side** and select **Left & Right** from **Stitch Images** in the Epson Scan 2 window. See the Epson Scan 2 help for details.

- ❑ Only use a Carrier Sheet designed for your scanner. The Carrier Sheet is automatically recognized by the scanner by detecting two small rectangular holes on the leading edge. Keep the holes clean and not covered.

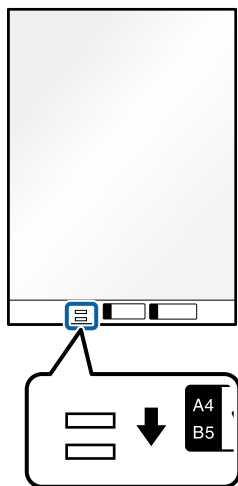

Related Information

- ➔ [“Carrier Sheet Codes” on page 26](#)
- ➔ [“Software Settings Required for Special Originals” on page 103](#)

Placing an Envelope

Note:

Make sure there is enough space in front of the scanner for the ejected originals.

1. Make sure the scanner position light () is on.

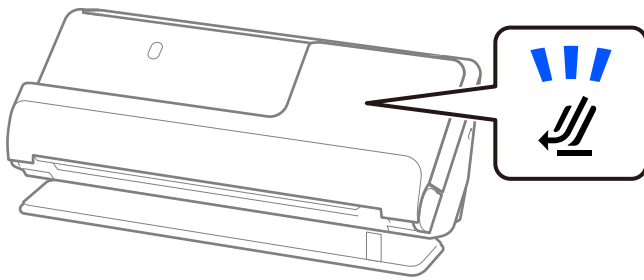

If the scanner position light () is off, pull the scanner position selector to tilt the scanner back.

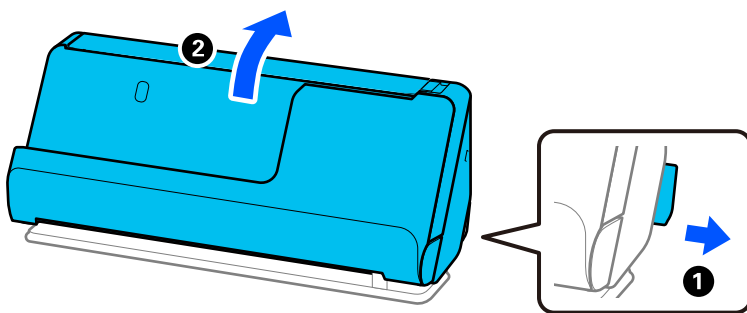

2. Open the input tray.

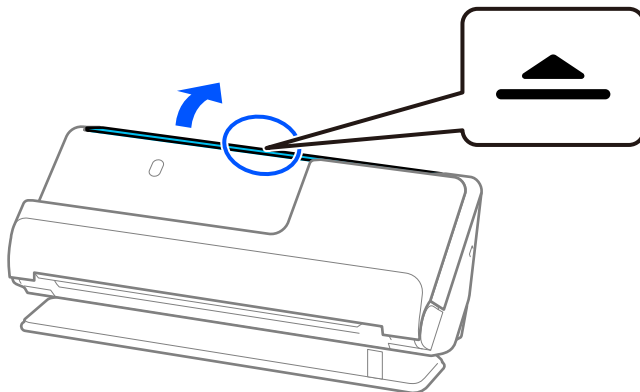

3. Raise the input tray extension.

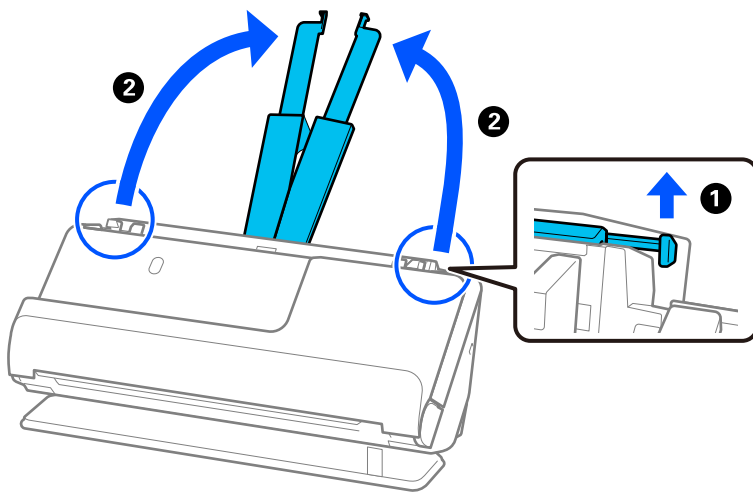

4. Move the edge guides to the edges of the input tray.

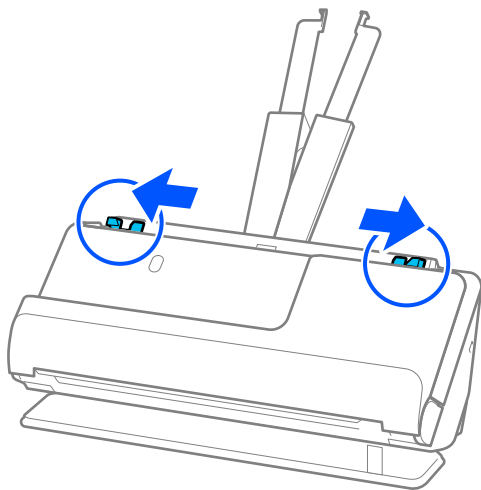

5. Load the envelope in a portrait orientation with the side to be scanned facing up. For envelopes with the opened edge (flap side) on the shorter side, you can load the envelope with the opened edge (flap side) facing up.

Insert the envelope into the ADF until it meets resistance.

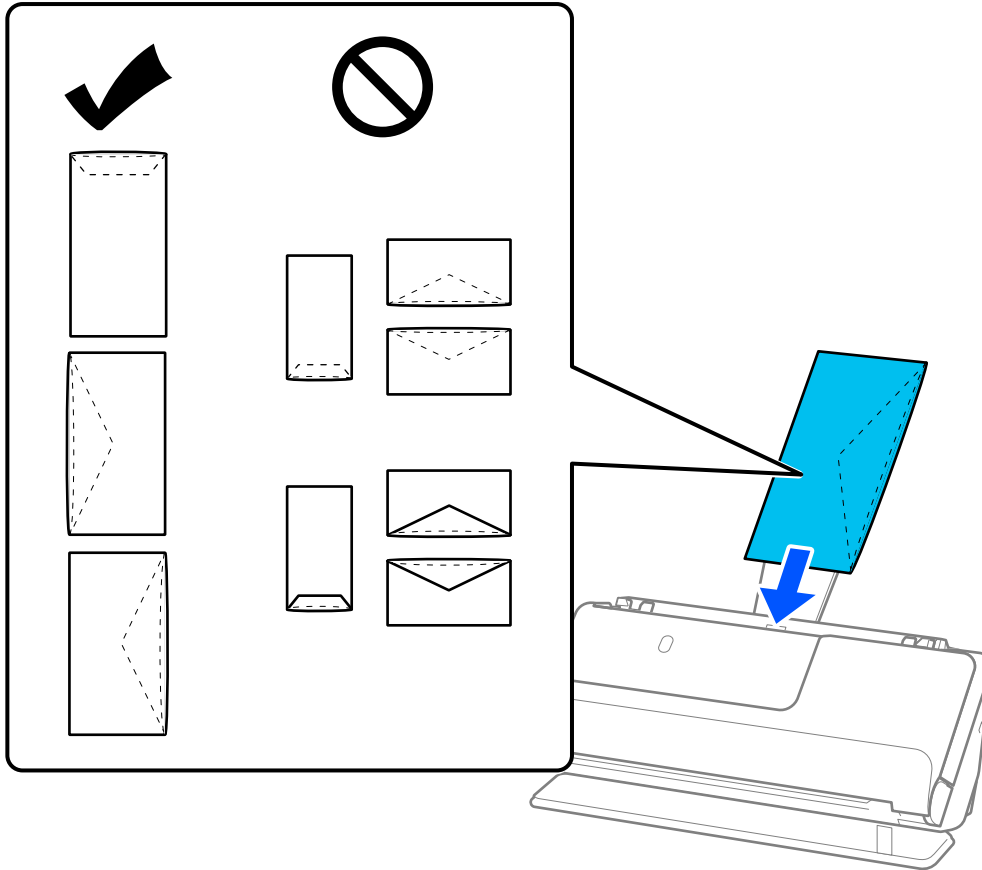

! Important:

Do not load envelopes with adhesives on them.

Note:

- Envelopes that are not cut cleanly at the flap edge when they are opened may not be scanned correctly.
- Envelopes that have not yet been sealed can be loaded with the flap open and facing up.

6. Adjust the edge guides to fit the edges of the envelope so that there are no gaps. Otherwise, the envelope may be fed skewed.

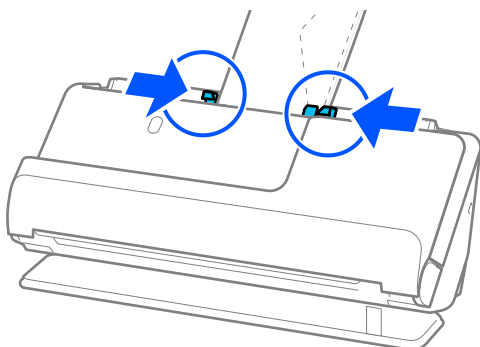

Note:

- ❑ If the edge guides are too far apart or too tight, the original may not be fed correctly. The edge guides should be aligned so that they lightly touch the edges of the original.
- ❑ We recommend selecting the appropriate rotation angle or **Auto** as the **Rotate** setting in the application.
- ❑ When scanning envelopes, make the appropriate settings on the Epson Scan 2 screen.

When you are using Document Capture Pro, you can open the window by pressing the **Detailed Settings** button on the **Scan Settings** screen.

Select **Main Settings** tab > **Detect Double Feed** > **Off**. See the Epson Scan 2 help for details.

If you have not disabled **Detect Double Feed** on the Epson Scan 2 screen and a double feed error occurs, remove the envelopes from the ADF and reload them.

Related Information

➔ [“Software Settings Required for Special Originals” on page 103](#)

Placing Irregular Shaped Originals

Note:

Make sure there is enough space in front of the scanner for the ejected originals.

1. Make sure the scanner position light () is on.

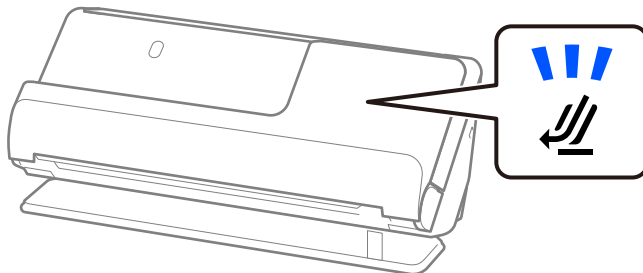

If the scanner position light () is off, pull the scanner position selector to tilt the scanner back.

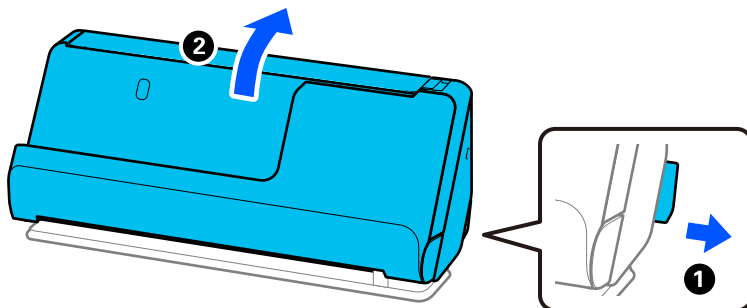

2. Open the input tray.

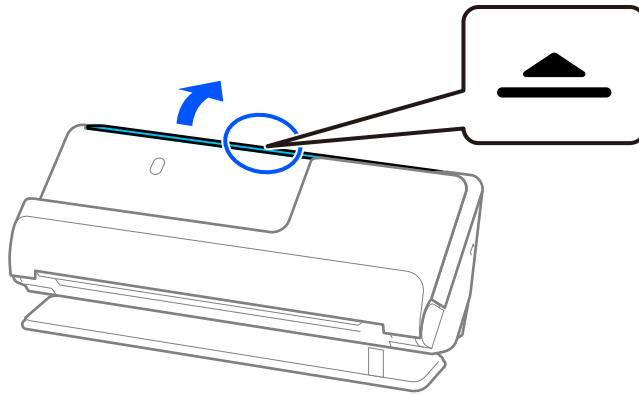

3. Raise the input tray extension.

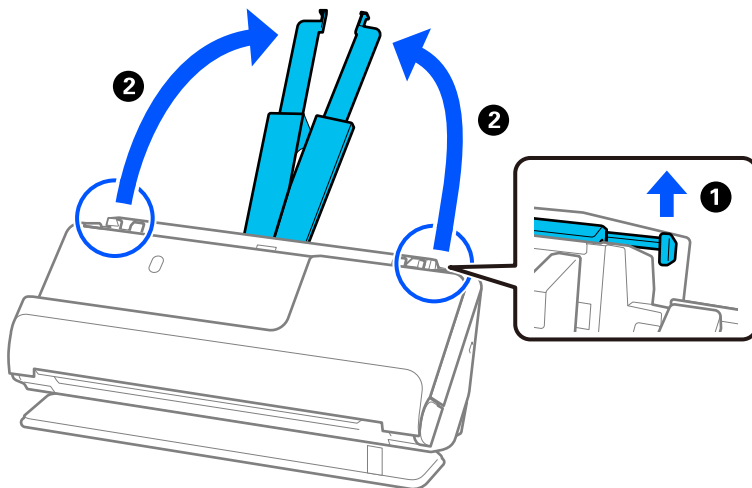

4. Move the edge guides to the edges of the input tray.

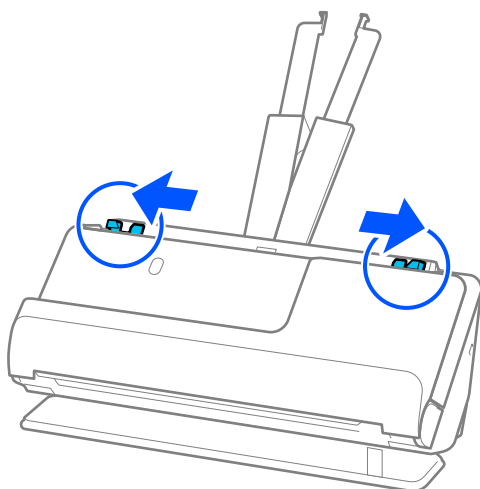

5. Place your original in the Carrier Sheet.

Place your original so that the back of the original is facing the side of the Carrier Sheet with the illustration.

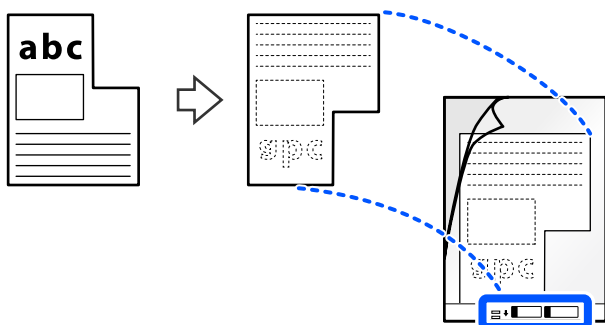

6. Turn over the Carrier Sheet.

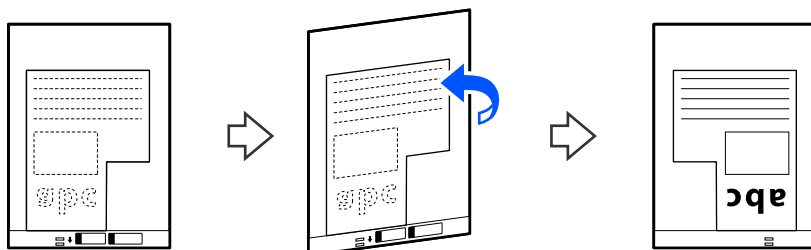

7. Load the Carrier Sheet into the input tray with the top edge facing into the ADF.
Insert the Carrier Sheet into the ADF until it meets resistance.

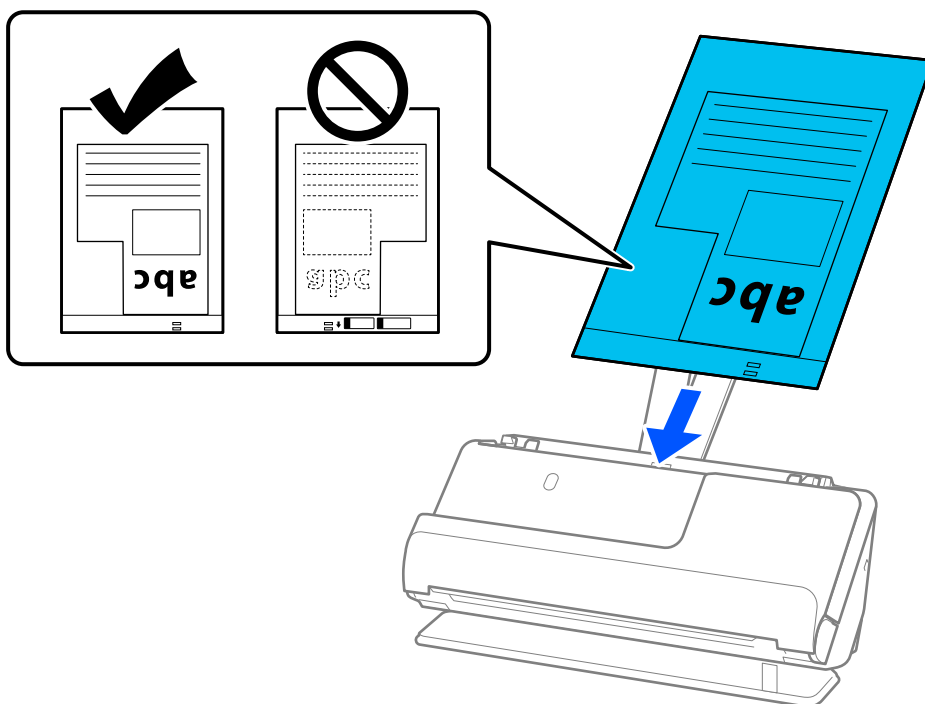

8. Align the edge guides with the Carrier Sheet so that there are no gaps. Otherwise, the Carrier Sheet may be fed skewed.

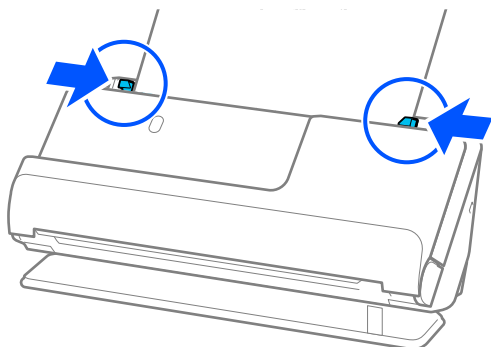

Note:

- ❑ If the edge guides are too far apart or too tight, the original may not be fed correctly. The edge guides should be aligned so that they lightly touch the edges of the original.
- ❑ Do not use a scratched Carrier Sheet or a Carrier Sheet that has been scanned more than 3,000 times.
- ❑ If you cannot find a **Document Size** that matches the original to be scanned, you need to make settings on the Epson Scan 2 screen.

When you are using Document Capture Pro, you can open the window by pressing the **Detailed Settings** button on the **Scan Settings** screen.

Select **Auto Detect** on the Epson Scan 2 screen, or select **Customize** to create a custom document size.

- ❑ When scanning with a Carrier Sheet, select **Auto Detect** as the **Document Size** setting in Epson Scan 2 to automatically scan the image while applying **Paper Skew** as the **Correct Document Skew** setting.
- ❑ Only use a Carrier Sheet designed for your scanner. The Carrier Sheet is automatically recognized by the scanner by detecting two small rectangular holes on the leading edge. Keep the holes in the Carrier Sheet clean and uncovered.

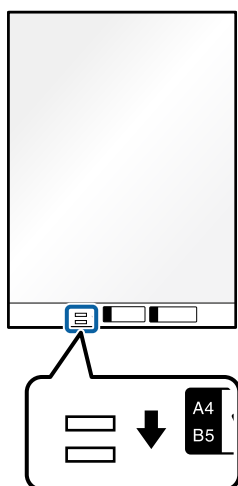

Related Information

- ➔ [“Carrier Sheet Codes” on page 26](#)
- ➔ [“Software Settings Required for Special Originals” on page 103](#)

Loading Batches of Originals with Different Paper Types and Sizes

You can place and scan batches of different size originals (50.8×50.8 mm (2.0×2.0 inches) to A4 or letter size) up to a total thickness of 2.4 mm (0.1 inches).

Caution:

- ❑ When placing and scanning originals that are a mixture of different sizes, originals may be fed askew because not all of the originals are supported by the edge guides.
- ❑ Originals may be jammed or fed askew if you set different types or very different sizes of originals, such as in the following cases.
 - Thin paper and thick paper
 - A4 size paper and card size paper
 - Combinations of long, narrow paper that extend far beyond the input tray extension (example: long receipts and so on)
 - Combinations of folded or wrinkled paper

If originals are fed askew, check the scanned images. If the image is skewed, reduce the number of originals loaded and scan again.

Note:

- ❑ If originals are jammed or not fed correctly, try to enable Slow Mode () to solve this problem.
- ❑ Alternatively, you can scan originals of different paper types and thickness by loading them one by one using **Automatic Feeding Mode**.

To use **Automatic Feeding Mode**, make the appropriate settings on the Epson Scan 2 screen.

When you are using Document Capture Pro, you can open the window by pressing the **Detailed Settings** button on the **Scan Settings** screen.

On the Epson Scan 2 screen, use **Automatic Feeding Mode** to scan while switching the position of the scanner according to the type of document.

1. Make sure the scanner position light () is off.

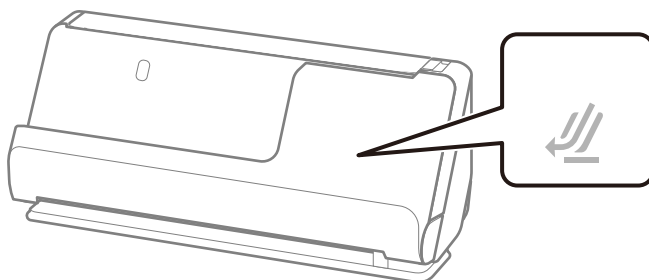

If the scanner position light () is on, pull the scanner position selector to tilt the scanner forward.

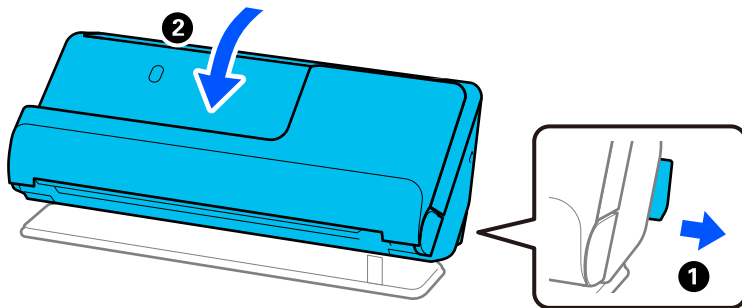

2. Open the input tray.

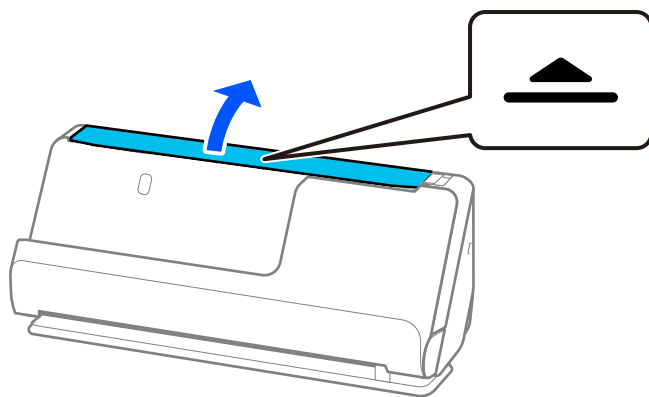

3. Raise the input tray extension.

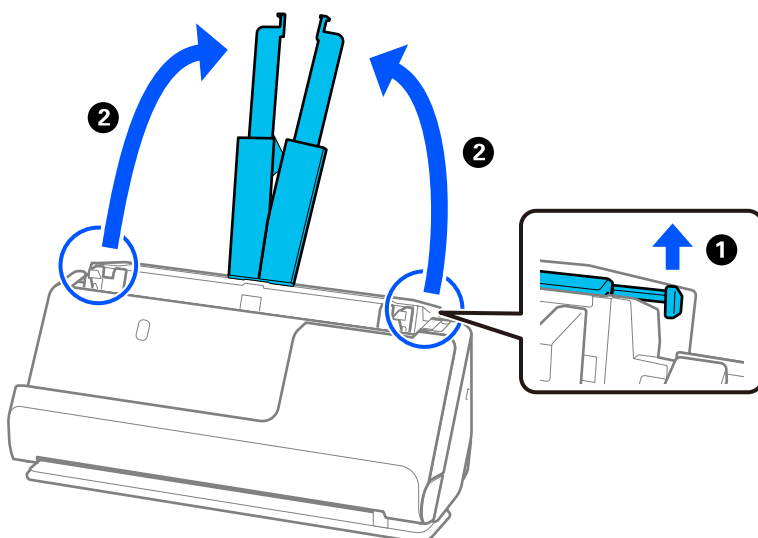

4. Move the edge guides to the edges of the input tray.

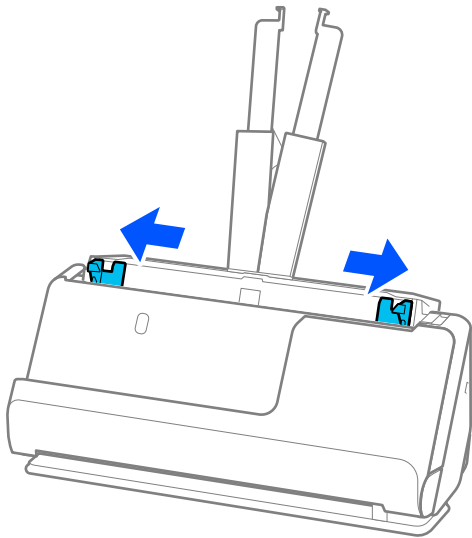

5. Load the originals with the side to be scanned facing up and in descending order of paper size with the widest at the back and the narrowest at the front of the input tray.

! *Important:*

Check the following points when setting different sizes of originals.

- Slide the originals with their leading edges aligned, until they meet resistance in the ADF.*
- Set the originals at the center of the input tray. Refer to the ▲ mark on the scanner as your guide.*
- Set the originals straight.*

If not, originals may be fed askew or jammed.

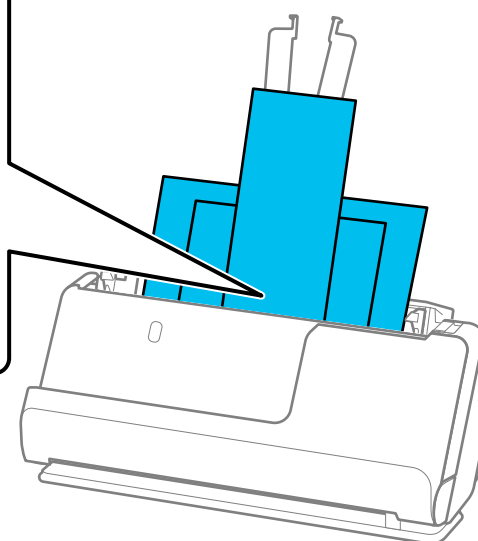
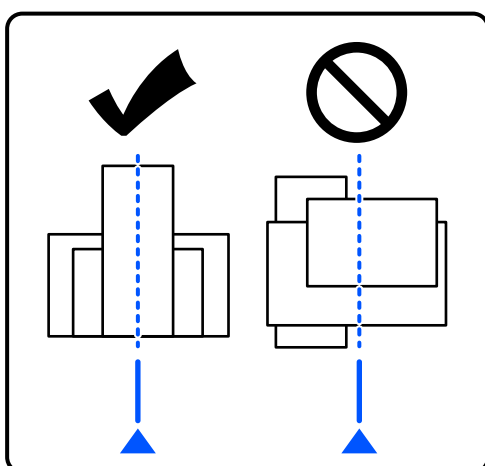

6. Align the edge guides with the widest original.

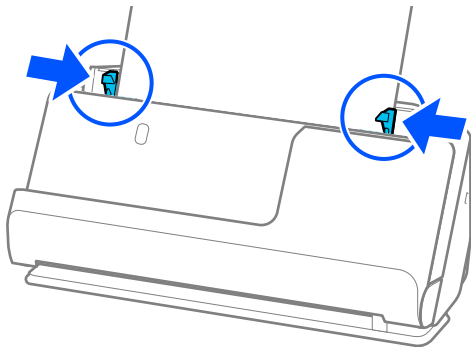

Note:

- ❑ If the edge guides are too far apart or too tight, the original may not be fed correctly. The edge guides should be aligned so that they lightly touch the edges of the original.
- ❑ Epson Scan 2 allows you to preview the first side of your original. Load only the first original into the ADF, and then press the **Preview** button. The preview window opens, the previewed image is displayed, and the page is ejected from the scanner.
Replace the ejected page together with the rest of the originals.
- ❑ When loading and previewing multiple originals at once, or if you cancel scanning in the middle of scanning a batch of originals, the second original will be fed a little bit into the ADF and then scanning stops. Open the scanner cover to remove it, and then load the page again together with the first page and the rest of the originals.
- ❑ Depending on the type of paper and the environment in which the scanner is being used, the original may fall from the front of the scanner after scanning. In this situation, load fewer originals into the scanner than the specified number of originals that can be loaded.

Related Information

- ➔ [“Scanning in Automatic Feeding Mode” on page 104](#)

Scanning

Scanning Using a Scanner Button.	87
Scanning from a Computer.	87
Setting a Job.	106

Scanning Using a Scanner Button

You can scan using the button on your scanner.

Note:

- ❑ *Make sure that Epson Scan 2 is installed on your computer and the scanner is connected to your computer correctly.*
- ❑ *When Document Capture Pro (Windows) or Document Capture (Mac OS) is installed on your computer, you can assign the job to a button on the scanner and run the job by pressing it.*

1. Place the original.
2. Press the  button.

Note:

See the Document Capture Pro (Windows) or Document Capture (Mac OS) help for details on button assignments.

Related Information

➔ [“Setting a Job” on page 106](#)

Scanning from a Computer

Scanning Using Document Capture Pro (Windows)

Document Capture Pro allows you to easily and efficiently digitize originals and forms to suit your needs.

The following functions are available with Document Capture Pro.

- ❑ You can manage and perform a set of operations, such as scanning and saving, as a "job".
- ❑ You can configure a "job" to save scanned images in various formats (PDF/BMP/JPEG/JPEG2000/TIFF/Multi-TIFF/PNG/DOCX/XLSX/PPTX).
- ❑ You can sort jobs automatically by inserting dividing paper between the originals or by using barcode information on the originals.
- ❑ You can output scanning information or items necessary for the scanned content as index data.
- ❑ You can set multiple destinations.
- ❑ You can scan using simple operations without having to create a job.

By using these functions, you can digitize paper documents more efficiently, such as scanning a large number of documents or using them over a network.

Note:

- ❑ *For detailed information on how to use Document Capture Pro, refer to the following URL:*
<https://support.epson.net/dcp/>
- ❑ *Document Capture Pro does not support Windows Server.*

What is a Job Scan?

By registering a series of frequently used operations as a job, you can execute these operations by simply selecting the job.

By assigning a job to the scanner's button, you can also execute the job from the control panel.

Performing a Job Scan

This section explains the workflow of scanning using an existing job.

1. Select the scanner you want to use from the Document Capture Pro top screen. When you start the software it automatically connects to the last scanner you used.

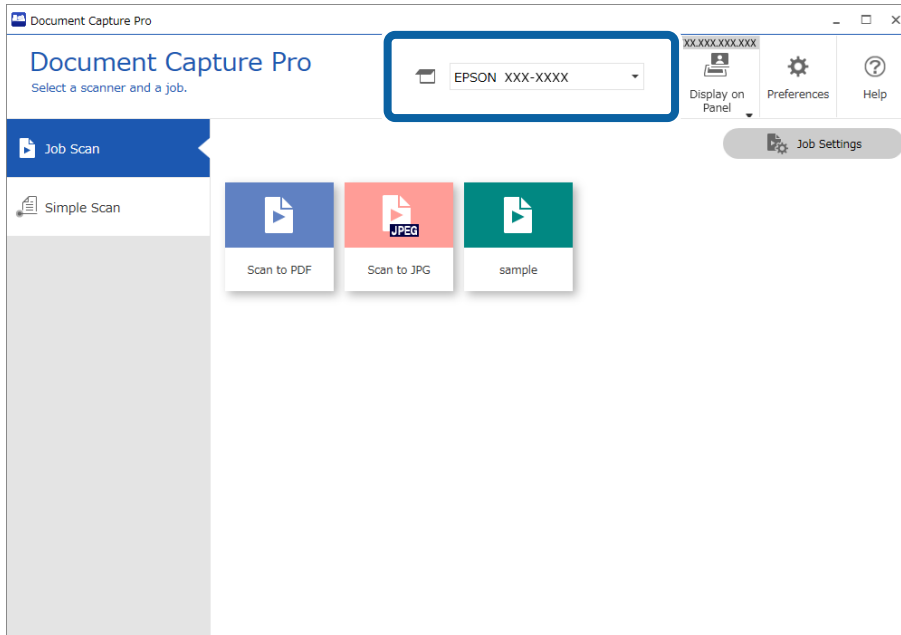

2. Click the **Job Scan** tab, and then click the icon of the job you want to perform.

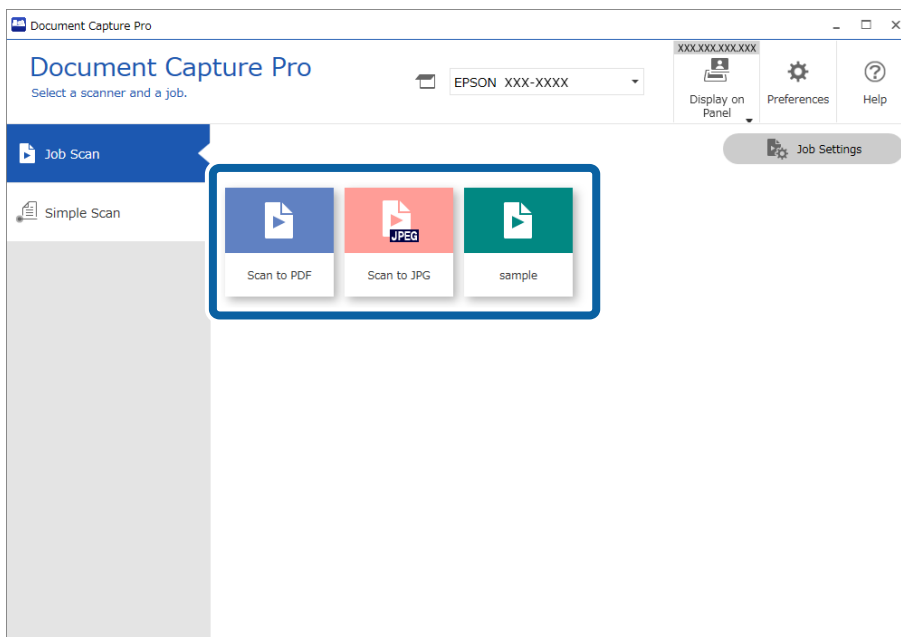

The selected job is performed.

When you perform a job for which **Show the preview while scanning** has been selected in the Scan Settings, a preview screen is displayed while scanning.

3. If you execute a job that contains the following elements in the File Name Settings, Separation Settings, or User-Defined Index Settings from Save Settings, and the elements are detected in the scanned page, the detection area is displayed on the image as a marquee. Correct the recognition results manually if necessary, or change the area and run the recognition again.

- OCR
- Barcode
- Form
- MRZ in passports
- MRZ in travel documents

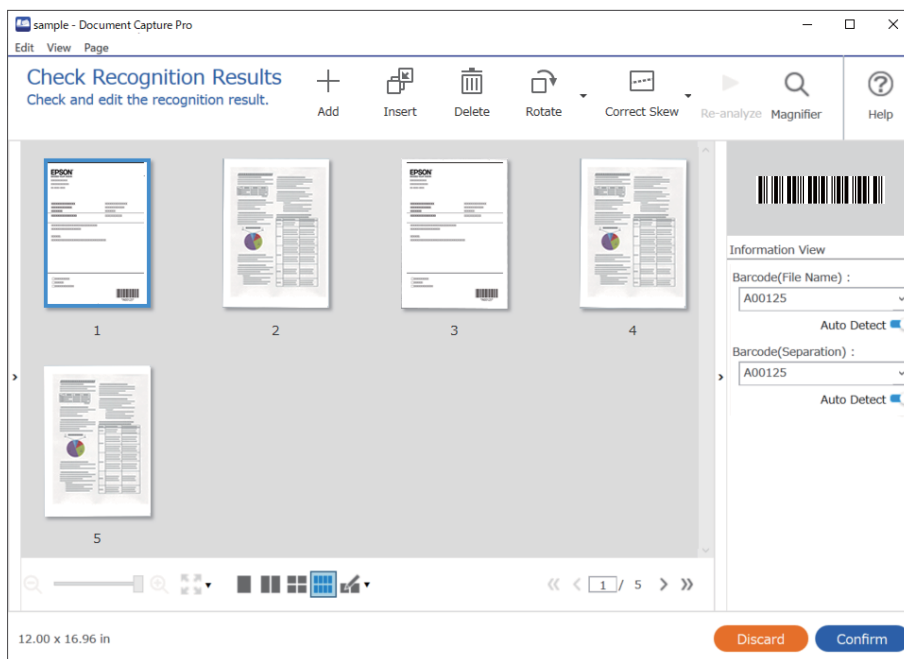

4. For jobs for which **Show Edit Page dialog before saving** has been selected in the Scan Settings, check the scan results on the **Edit Scanned Results** screen after scanning, and then make edits as necessary.

You can check and edit the following on the **Edit Scanned Results** screen.

- Results of separation
- Scanned images

Index data

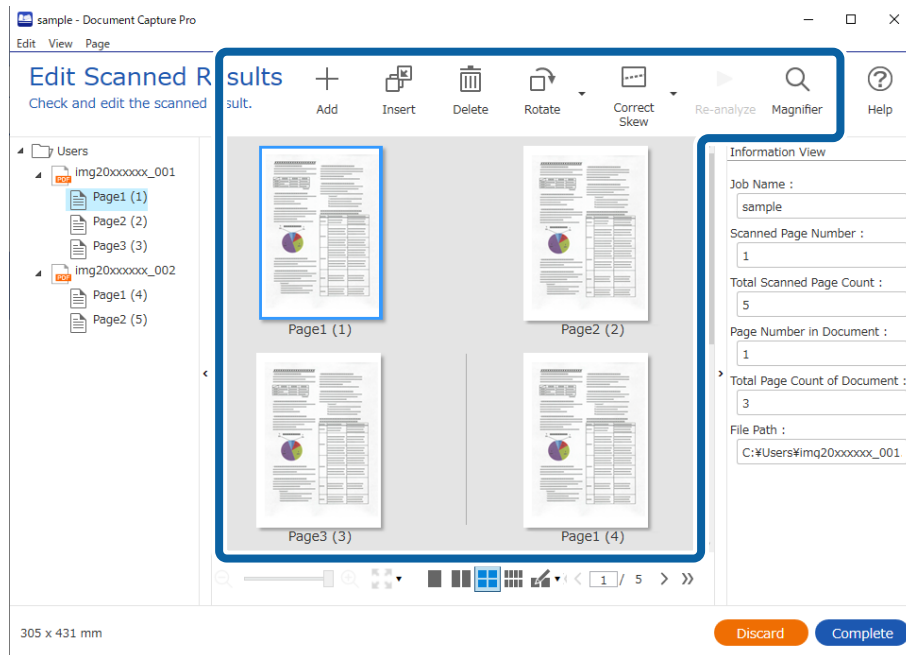

5. Click **Complete** to finish performing the Job Scan.

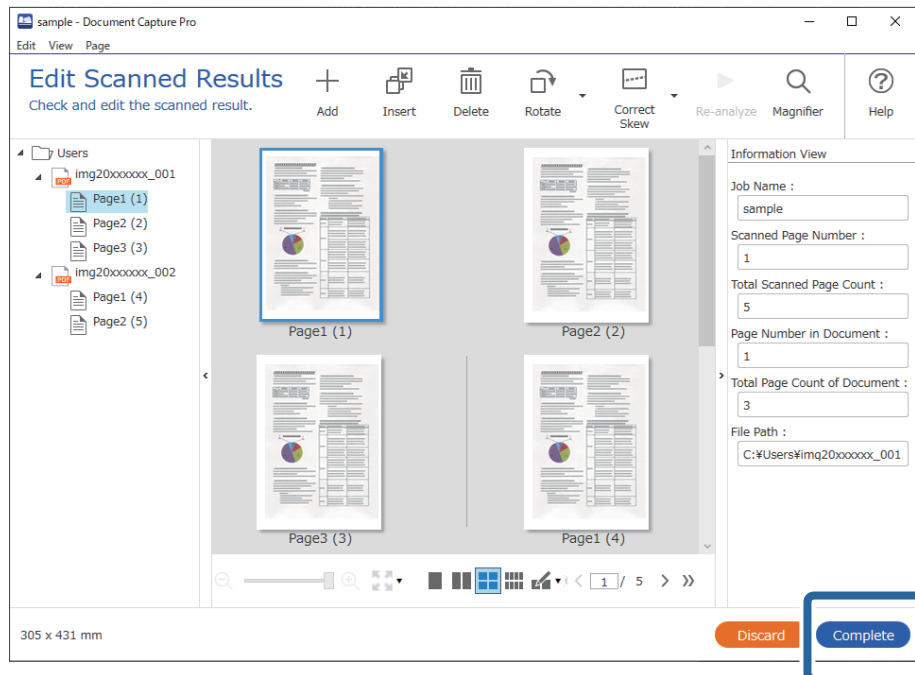

What is a Simple Scan?

You can scan documents without creating a job. Check the results after scanning, and then save or set the destination.

By assigning Simple Scan Settings to the scanner's button, you can also execute the Simple Scan from the control panel.

Performing a Simple Scan

This section explains the workflow of scanning without using a job.

1. Select the scanner you want to use from the Document Capture Pro top screen. When you start the software it automatically connects to the last scanner you used.

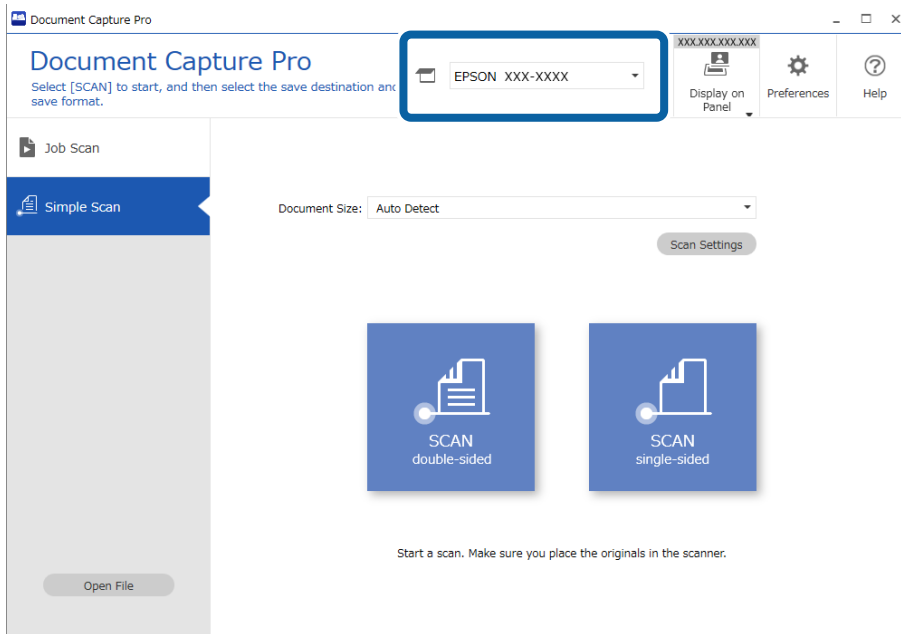

2. Click the **Simple Scan** tab, select **Document Size**, and then click the **SCAN double-sided** or **SCAN single-sided** icon.

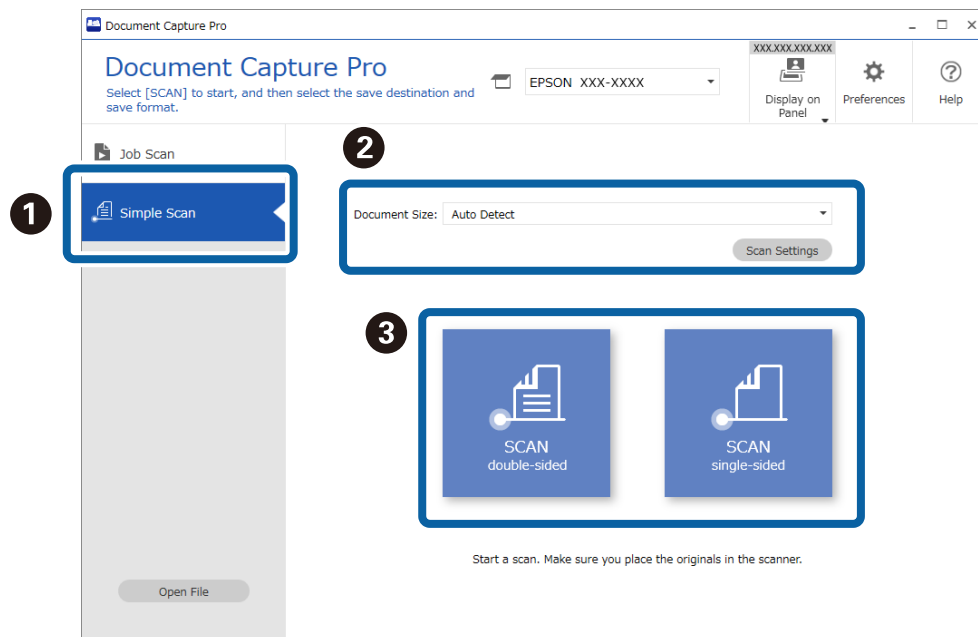

Note:

Click **Scan Settings** to set the resolution. You can make more detailed settings from Epson Scan 2.

The image being scanned is displayed.

3. Check the scan results on the **Edit Scanned Results** screen, make edits as necessary, and then click **Next**.

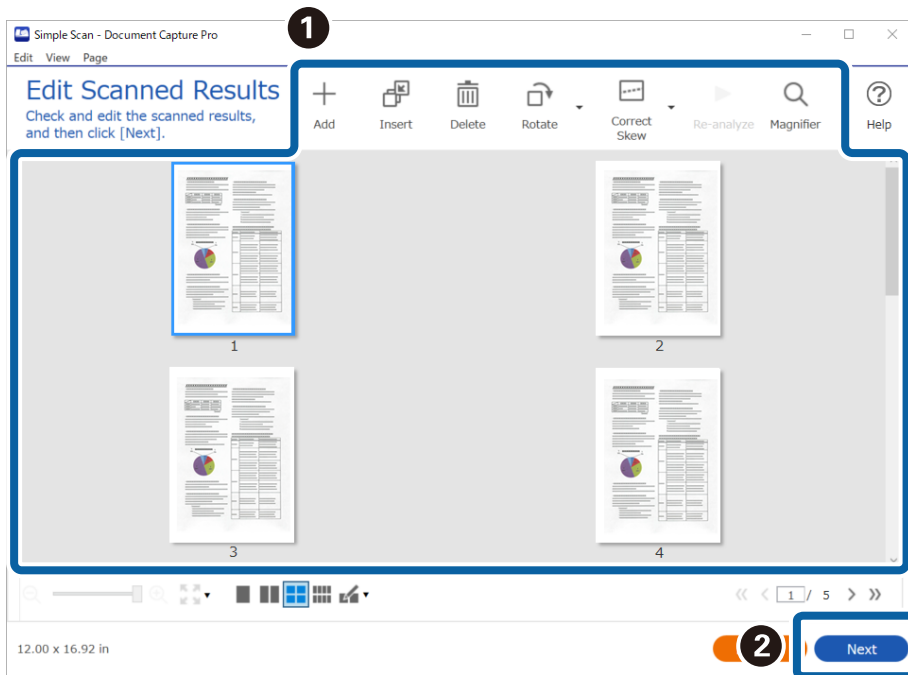

4. Select the destination for the scanned data on the **Select Destination** screen.

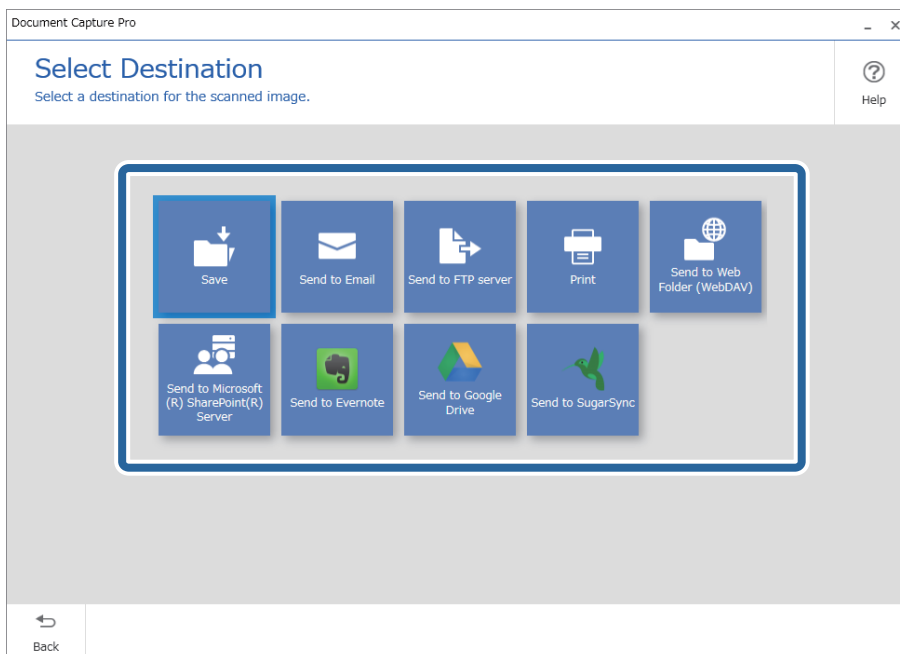

5. Set the file you want to save and the save format on the **Destination Settings** screen. You can also make more detailed settings according to the destination.

Displayed items depend on the destination. The following screen is displayed when **Save** is selected.

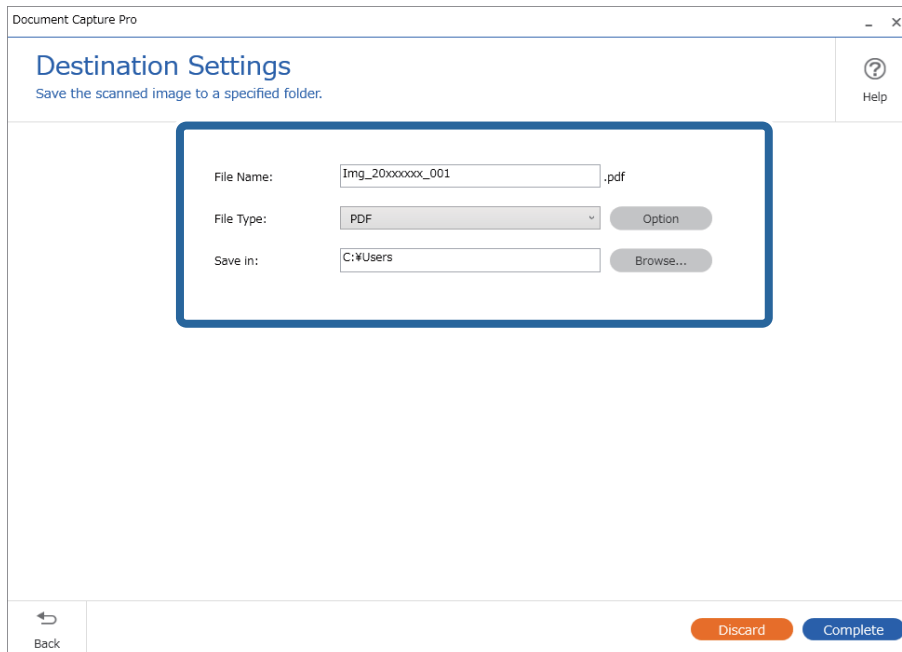

6. Click **Complete** to finish performing the Simple Scan.

Scanning Using Document Capture (Mac OS)

This application allows you to perform various tasks such as saving the image to your computer, sending it by email, printing, and uploading to a server or a cloud service. You can also register scanning settings for a job to simplify scanning operations.

See the Document Capture help for details on the features.

Note:

Do not use the Fast User Switching function while using your scanner.

1. Start Document Capture.

Select **Finder > Go > Applications > Epson Software > Document Capture**.

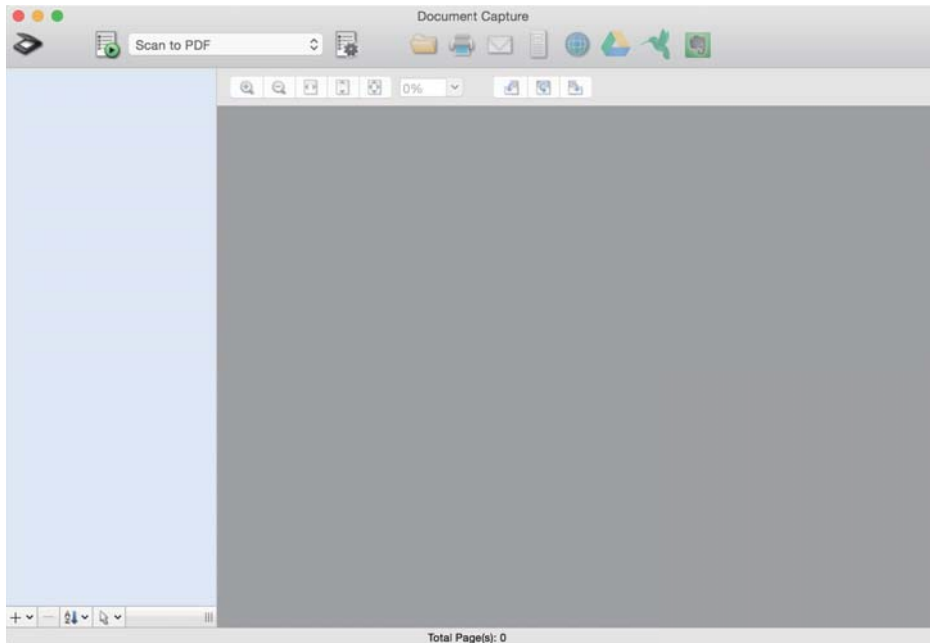

Note:

You may need to select the scanner you want to use from the scanners list.

2. Click .

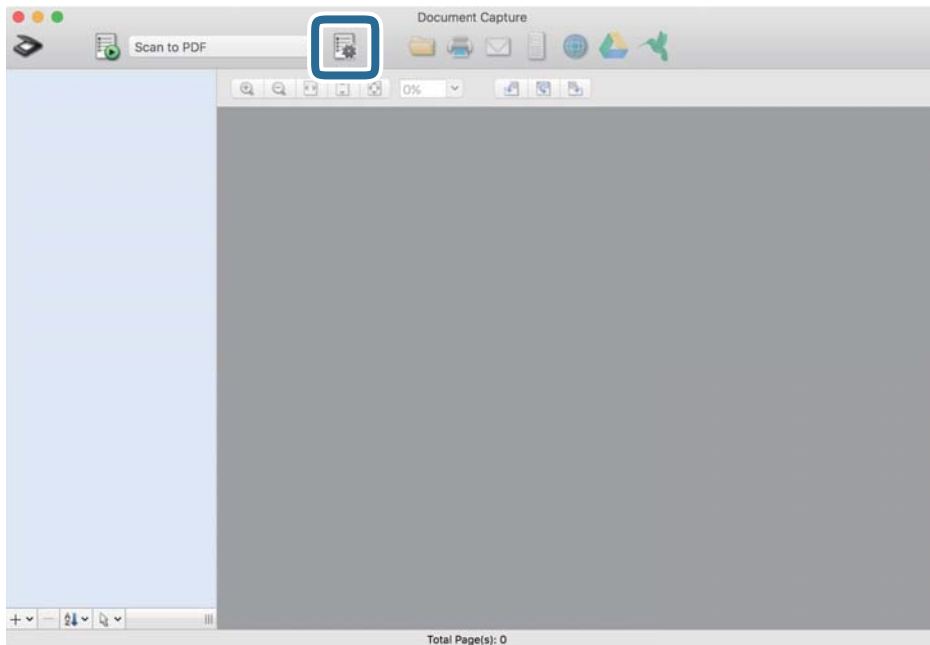

The **Job List** screen is displayed.

Note:

A preset job is available that allows you to save scanned images as a PDF. When using this job, skip this procedure and go to procedure 10.

3. Click the + icon.

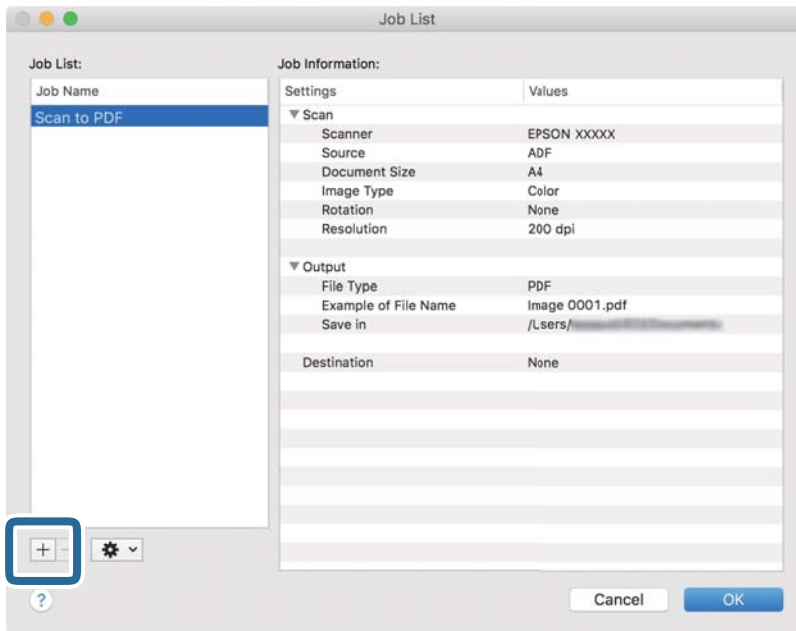

The job setting screen is displayed.

4. Set the **Job Name**.

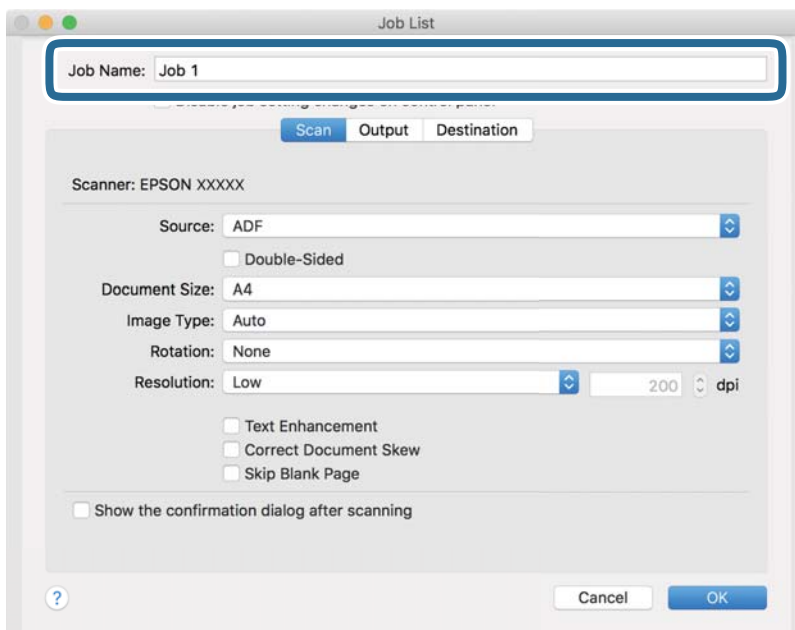

5. Make scanning settings on the **Scan** tab.

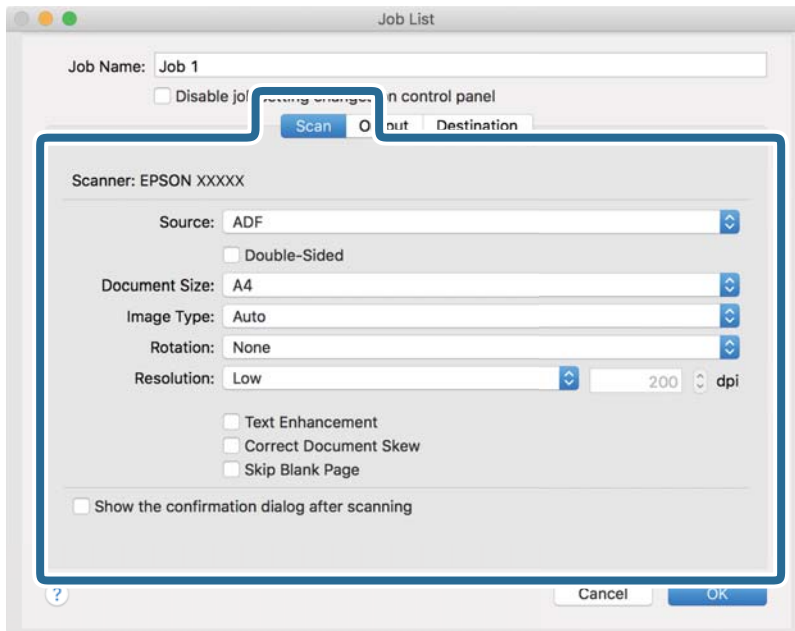

- Source:** Select the source where the original is placed. Select double-sided to scan both sides of the originals.
- Document Size:** Select the size of the original you placed.
- Image Type:** Select the color you want to use to save the scanned image.
- Rotation:** Select the rotation angle depending on the original you want to scan.
- Resolution:** Select the resolution.

Note:

You can also adjust the image using following items.

- Text Enhancement:** Select to make blurred letters in the original clear and sharp.
- Correct Document Skew:** Select to correct the slant of the original.
- Skip Blank Page:** Select to skip blank pages if there are any in the originals.

6. Click **Output**, and then make the output settings.

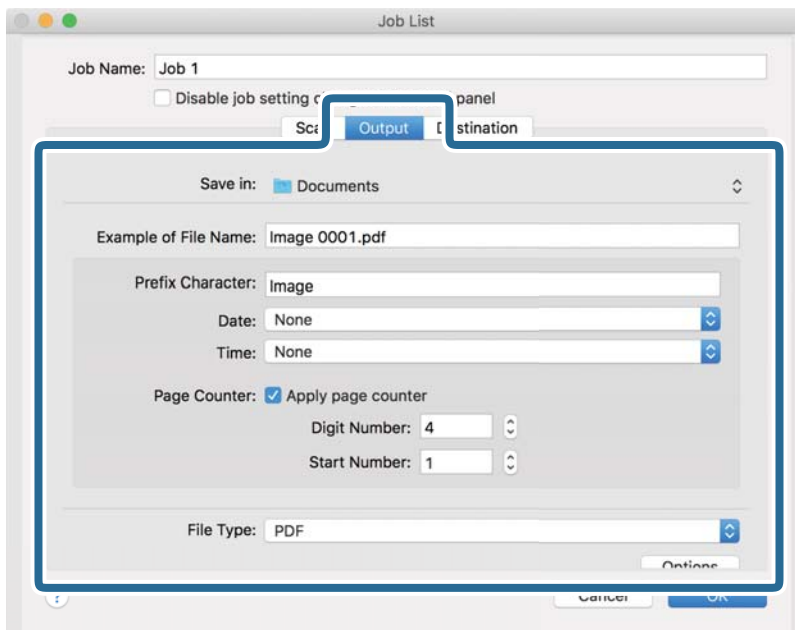

- Save in:** Select the save folder for the scanned image.
- Example of File Name:** Display an example of the file name for the current settings.
- Prefix Character:** Set a prefix for the file name.
- Date:** Add the date to the file name.
- Time:** Add the time to the file name.
- Page Counter:** Add the page counter to the file name.
- File Type:** Select the save format from the list. Click **Options** to make detailed settings for the file.

7. Click **Destination**, and then select the **Destination**.

Destination setting items are displayed according to the destination you selected. Make detailed settings as necessary. Click the ? (Help) icon for details on each item.

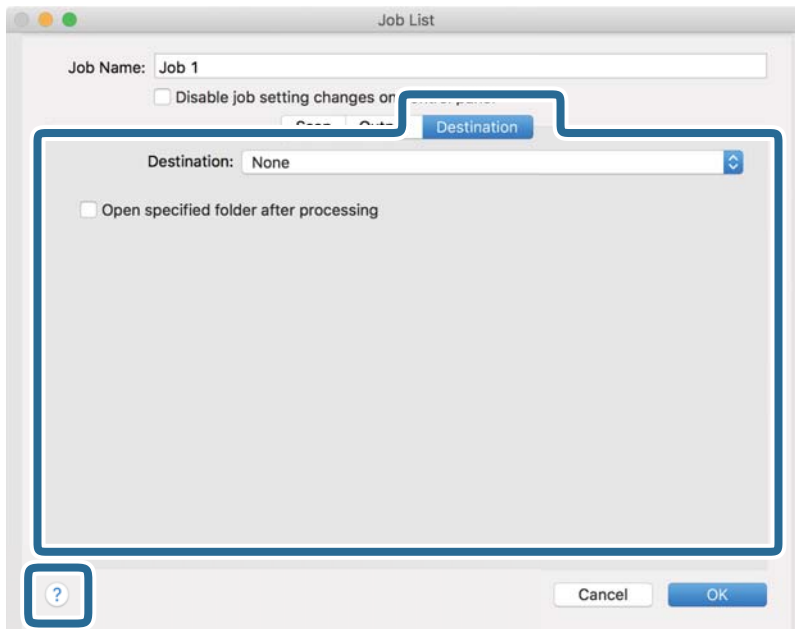

Note:

- If you want to upload to a cloud service, you need to set up your account with the cloud service in advance.
- If you want to use Evernote as the destination, download the Evernote application from the Evernote Corporation Website and install it before using this feature.

8. Click **OK** to close the job settings screen.
9. Click **OK** to close the **Job List** screen.
10. Place the original.

11. Select the job from the pull down list, and then click the  icon.

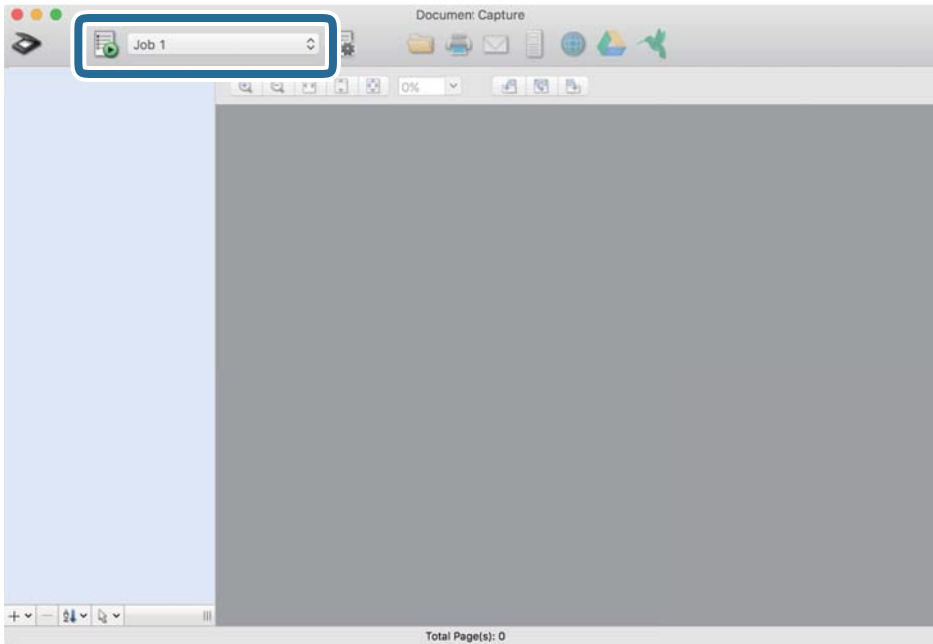

The selected job is performed.

12. Follow the on-screen instructions.

The scanned image is saved using the settings you made for the job.

Note:

You can scan the originals and send the scanned image without using the job. Click  and make scanning settings, and then click **Preview Scan**. Next, click the destination to which you want to send the scanned image.

Scanning Using Epson Scan 2

You can scan the originals using detailed settings that are suitable for text documents.

1. Place the original.
2. Start Epson Scan 2.
 - Windows 11
Click the start button, and then select **All apps > EPSON > Epson Scan 2**.
 - Windows 10/Windows Server 2022/Windows Server 2019/Windows Server 2016
Click the start button, and then select **EPSON > Epson Scan 2**.
 - Windows 8.1/Windows 8/Windows Server 2012 R2/Windows Server 2012
Enter the application name in the search charm, and then select the displayed icon.
 - Windows 7/Windows Server 2008 R2/Windows Server 2008
Click the start button, and then select **All Programs or Programs > EPSON > Epson Scan 2 > Epson Scan 2**.

❑ Mac OS

Select **Go > Applications > Epson Software > Epson Scan 2**.

3. Make the following settings on the **Main Settings** tab.

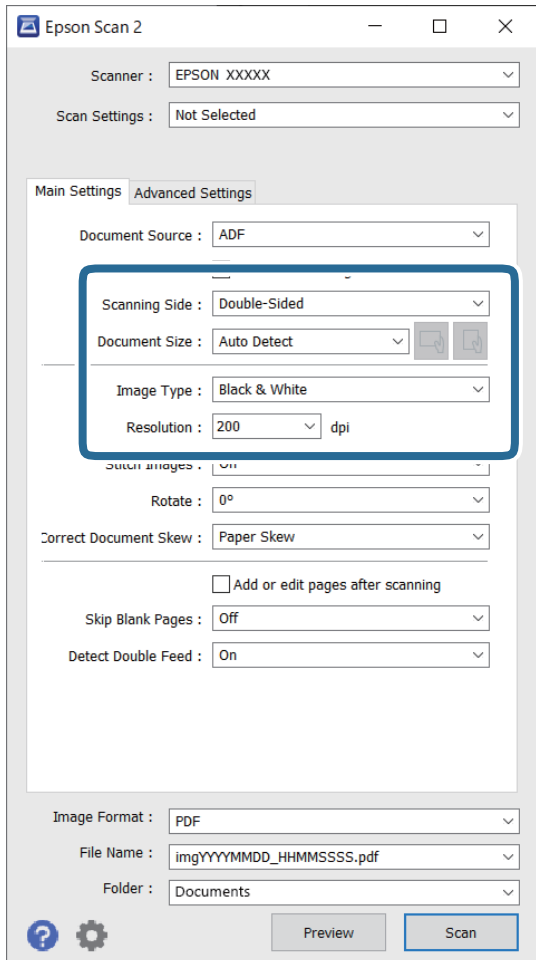

❑ **Scanning Side:** Select the side of the original you want to scan. When scanning 2-sided originals, select **Double-Sided**.

❑ **Document Size:** Select the size of the original you placed.

❑  (Original orientation) buttons: Select the set orientation of the original you placed. Depending on the size of the original, this item may be set automatically and cannot be changed.

❑ **Image Type:** Select the color you want to use to save the scanned image.

❑ **Resolution:** Set the resolution.

Note:

- The **Document Source** is automatically set as **ADF**.
- On the **Main Settings** tab, you can also make the following settings.
 - Stitch Images:** Select to stitch the images on the front and back when scanning both sides of the original.
 - Rotate:** Select to rotate the original clockwise and scan it.
 - Correct Document Skew:** Select to correct the slant of the original.
 - Add or edit pages after scanning:** Select to add different originals or edit (rotate, move, and delete) the scanned pages after scanning.
 - Skip Blank Pages:** Select to skip blank pages if any in the originals.
 - Detect Double Feed:** Select to display a warning when multiple originals are fed at a time.

4. Make other scan settings if necessary.

- You can preview the scanned image of the first side of the first page of the originals. Load only the first original into the ADF, and then click the **Preview** button. The preview window opens, the previewed image is displayed, and the page is ejected from the scanner.
Replace the ejected page together with the rest of the originals.
- On the **Advanced Settings** tab, you can make image adjustments using detailed settings which are suitable for text documents, such as the following.
 - Remove Background:** Removes the background of the originals.
 - Text Enhancement:** You can make blurred letters in the original clear and sharp.
 - Auto Area Segmentation:** You can make letters clear and images smooth when performing black and white scanning for a document that contains images.
 - Dropout:** You can remove the color specified for the scanned image, and then save it in grayscale or black and white. For example, you can erase marks or notes you wrote in the margins with color pen when scanning.
 - Color Enhance:** You can enhance the color specified for the scanned image, and then save it in grayscale or black and white. For example, you can enhance letters or lines that are in light colors.

Note:

Some items may not be available depending on other settings you made.

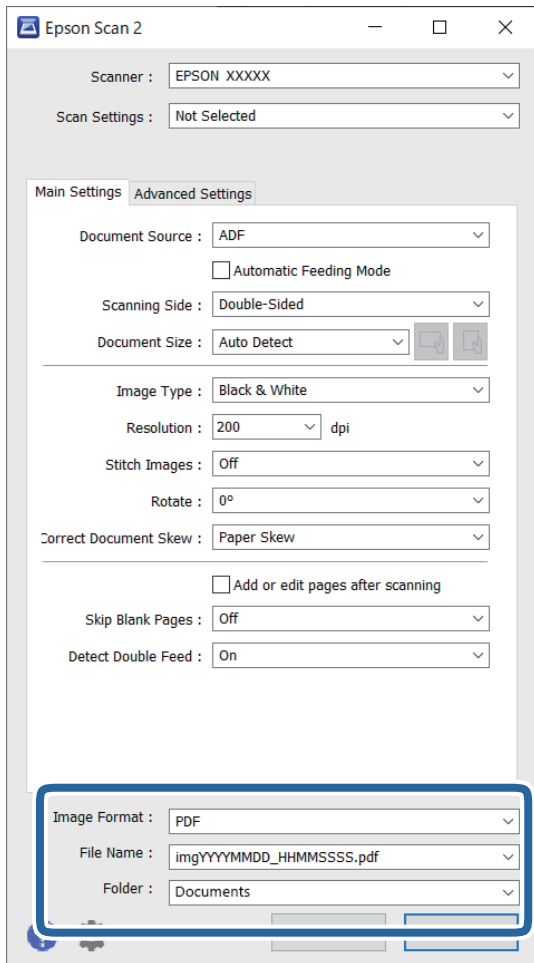

5. Set the file saving settings.



- ❑ **Image Format:** Select the file format for saving the scanned image from the list.
You can make detailed settings for each file format except BITMAP and PNG. After selecting the save format, select **Options** from the list.
- ❑ **File Name:** Confirm the displayed file name.
You can change settings for the file name by selecting **Settings** from the list.
- ❑ **Folder:** Select the save folder for the scanned image from the list.
You can select another folder or create a new folder by selecting **Select** from the list.

6. Click **Scan**.

Note:

- ❑ You can also start scanning by pressing  button on the scanner.
- ❑ When scanning originals that are likely to jam, for example thin paper, press the  (Slow Mode) button on the control panel to slow down the scanning speed.

Pressing the  button once slows down the paper feeding speed; press it again to return to normal speed.

The scanned image is saved to the folder you specified.

Software Settings Required for Special Originals

You need to set certain items on the **Main Settings** tab on the Epson Scan 2 screen when scanning special originals. When you are using Document Capture Pro, you can open the window by pressing the **Detailed Settings** button on the **Scan Settings** screen.

Type of Original	Required Settings
Envelopes	Select Off in Detect Double Feed .
Plastic cards	Select Plastic Card in the Document Size list, or select Off in Detect Double Feed .
Carrier Sheet	<p><input type="checkbox"/> If you select Auto Detect from the Document Size list, skewing of the original is automatically corrected even if you select Off in Correct Document Skew.</p> <p><input type="checkbox"/> If you select any other size than Auto Detect from the Document Size list, you can only use Contents Skew when using Correct Document Skew.</p> <p>Selecting Paper Skew will not be applied. When you select Paper and Contents Skew, only contents skew is corrected.</p>
Booklets	Select Booklets from Scan Settings .
Passport/Passport Carrier Sheet	Select Auto Detect from Document Size . Automatically detects and scans passports. You need to set this to save only the ID page of your passport. Select Passport in Scan Settings , and select Settings in Document Size . Select Save ID page only when scanning passports on the Document Size Settings screen.
Large size originals	If the size of the original you want to scan is not listed in Document Size , select Customize . Next, create the size manually on the window.
Long paper	If the size is not listed on the Document Size list, select Auto Detect (Long Paper) or select Customize to create a custom document size.
Laminated cards	To scan transparent areas around the document, select Settings in Document Size to open the Document Size Settings screen. Next, select Scan laminated card in the displayed window. <i>Note:</i> <i>The appropriate effects may not be achieved depending on the original. If transparent areas around the document cannot be scanned, select Customize from the Document Size list, and then create the size manually.</i>

Setting a Resolution That Suits the Scanning Purpose

Advantages and Disadvantages of Increasing the Resolution

Resolution indicates the number of pixels (smallest area of an image) for each inch (25.4 mm), and is measured in dpi (dots per inch). The advantage of increasing the resolution is that the details in the image become fine. The disadvantage is that the file size becomes large.

- File size becomes large
(When you double the resolution, the file size becomes about four times larger.)
- Scanning, saving, and reading the image takes a long time
- Sending and receiving emails or faxes takes a long time
- The image becomes too large to fit the display or print on the paper

List of Recommended Resolutions to Suit Your Purpose

See the table and set the appropriate resolution for the purpose of your scanned image.

Purpose	Resolution (Reference)
Displaying on a screen Sending by email	Up to 200 dpi
Using Optical Character Recognition (OCR) Creating a text searchable PDF	200 to 300 dpi
Printing using a printer Sending by fax	200 to 300 dpi

Software Image Quality Adjustment Features

The Epson Scan 2 (scanner driver) feature allows you to adjust the image quality when scanning. When you are using Document Capture Pro, you can open the Epson Scan 2 window by clicking the **Detailed Settings** button on the scan settings screen.

You can adjust the image quality of the scanned images using the features on the **Advanced Settings** tab. For more details on each feature, see the help on the screen displayed.

Note:

Some items may not be available depending on other settings you made.

Scanning in Automatic Feeding Mode

In Automatic Feeding Mode, scanning starts automatically when originals are loaded into the ADF. This is useful when scanning originals one by one.

When you are using Document Capture Pro, you can also use Automatic Feeding Mode.

1. Start Epson Scan 2.

Note:

*When you are using Document Capture Pro, you can open the Epson Scan 2 window by clicking the **Detailed Settings** button on the scan settings screen.*

2. Click the **Main Settings** tab > **Automatic Feeding Mode**.

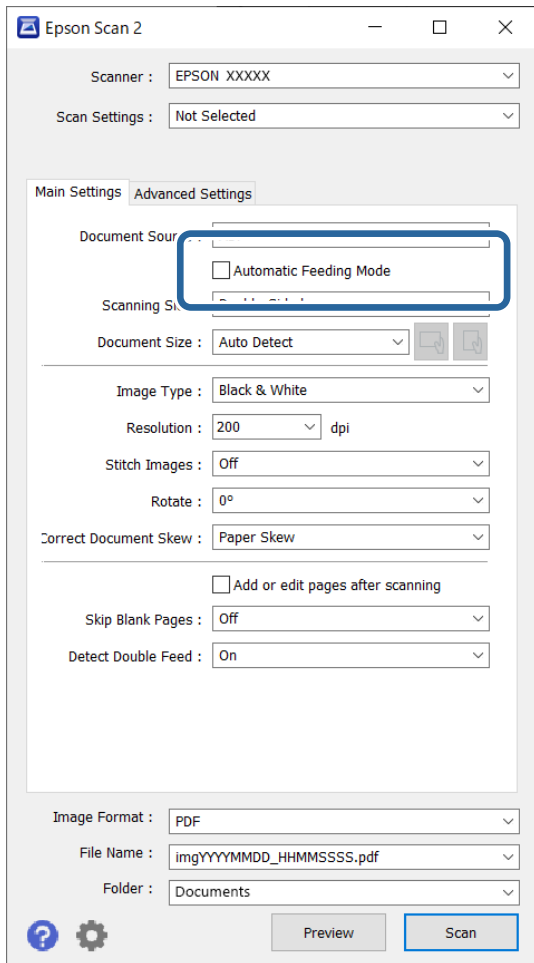

3. Specify other settings for scanning on the settings screen.

Note:

You can make timeout settings to exit **Automatic Feeding Mode**.

Select **Settings** on the **Document Source** list to open the **Document Source Settings** window. Set **Automatic Feeding Mode Timeout (seconds)** on the screen displayed.

4. Click **Scan**.

Note:

When you are using **Document Capture Pro**, click **Save** to save the scan settings. When you start scanning, **Automatic Feeding Mode** starts.

Automatic Feeding Mode starts.

5. Change the position of the scanner according to the type of original, adjust the edge guides, and then place the original in the ADF.

Note:

When scanning originals that are likely to jam, for example thin paper, press the  (Slow Mode) button before placing the original to slow down the scanning speed.

Scanning starts automatically.

6. After scanning stops, place the next original in the ADF.

Repeat this procedure until you have scanned all originals.

7. After you have scanned all originals, exit Automatic Feeding Mode.

Press the  button on the scanner or press **Finish** on the **Automatic Feeding Mode** screen displayed on your computer.

The scanned image is saved to the folder you specified.

Setting a Job

You can register a set of operations, such as Scan-Save-Send, as a "job".

By registering a series of operations in advance as a job using Document Capture Pro (Windows) or Document Capture (Mac OS), you can perform all of the operations by simply selecting the job.

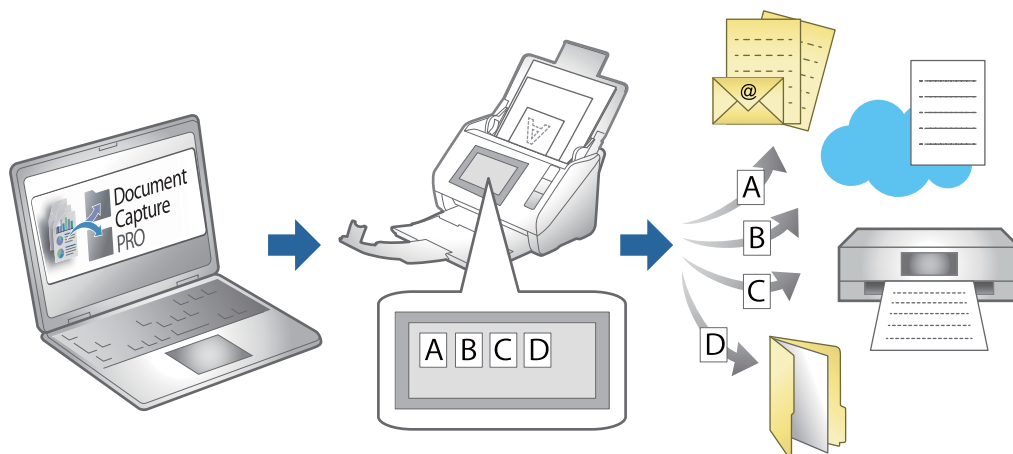

Creating a Job and Assigning a Job to the Control Panel (Windows)

See the Document Capture Pro manual for details. Access the URL below to view the latest manual.

<https://support.epson.net/dcp/>

Note:

There is a preset job that saves scanned images as PDFs.

Creating and Registering a Job (Mac OS)

Explains how to set a job in Document Capture. See the Document Capture help for details on the features.

1. Start Document Capture.
2. Click the  icon on the main window.
The **Job List** window is displayed.

3. Click the + icon.

The **Job Settings** window is displayed.

4. Make the job settings on the **Job Settings** window.

Job Name: Enter the name of the job you want to register.

Scan: Make scan settings such as the size of the originals or the resolution.

Output: Set the saving destination, the saving format, the naming rules of the files, and so on.

Destination: Select the destination of the scanned images. You can send them by email or forward them to an FTP server or Web server.

5. Click **OK** to return to the **Job List** window.

The created job is registered in the **Job List**.

6. Click **OK** to return to the main window.

Assigning a Job to the Control Panel (Mac OS)

Explains how to assign a job to the scanner's control panel in Document Capture. See the Document Capture help for details on the features.

1. Start Document Capture.

2. Click the  icon on the main window.

The **Job List** window is displayed.

3. Click the  icon and select **Event Settings**.

4. Select the job you want to run on the control panel from the pull-down menu.

5. Click **OK** to return to the **Job List** window.

The job is assigned to the scanner's control panel.

6. Click **OK** to return to the main window.

Useful Features

Setting the Glass Surface Stain Detection Feature.	109
Setting the Document Protection Feature.	110
Setting the Operation when a Double-feed is Detected.	111

Setting the Glass Surface Stain Detection Feature

Vertical lines (streaks) may appear in the image due to dust or dirt on the glass surface inside the scanner.

When **Detect Glass Dirt** is set to On, the scanner detects any stains on the glass surface inside the scanner and displays a notification on your computer screen.

When this notification is displayed, clean the glass surface inside the scanner with the dedicated cleaning kit or a soft cloth.

The default setting is **Off**.

1. Start Epson Scan 2 Utility.

Windows 11/Windows Server 2022

Click the start button, and then select **All apps > EPSON > Epson Scan 2 Utility**.

Windows 10/Windows Server 2016

Click the start button, and then select **EPSON > Epson Scan 2 Utility**.

Windows 8.1/Windows 8/Windows Server 2012 R2/Windows Server 2012

Enter the application name in the search charm, and then select the displayed icon.

Windows 7/Windows Server 2008 R2/Windows Server 2008

Click the start button, and then select **All Programs (or Programs) > EPSON > Epson Scan 2 > Epson Scan 2 Utility**.

Mac OS

Select **Go > Applications > Epson Software > Epson Scan 2 Utility**.

2. Make the following settings on the **Scanner Setting** tab.

Set **Detect Glass Dirt** to **On-Low** or **On-High**.

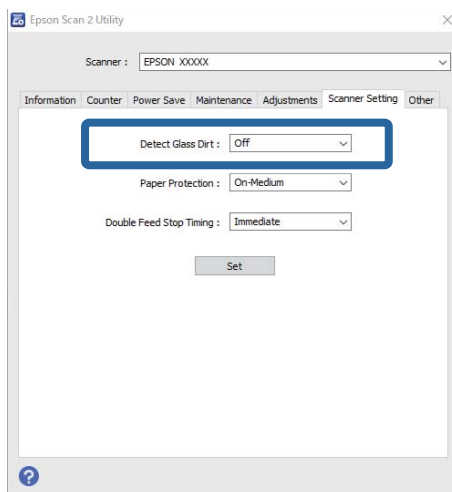

Note:

Some stains may not be detected correctly.

If detection does not work correctly, try changing the settings.

If no stains are detected, select **On-High**. If stains are detected incorrectly, select **On-Low** or **Off**.

3. Click **Set** to apply the settings to the scanner.

Setting the Document Protection Feature

To reduce damage to the document, scanning stops immediately when the following conditions are detected.

- A paper feed error has occurred
- An original is fed at an angle
- The combination of the original and the scanner position does not match

The default setting is **On-Medium**.



Important:

- This feature does not prevent all originals from being damaged.
- Paper feed errors may not be detected depending on the condition of the originals being fed.

1. Start Epson Scan 2 Utility.

- Windows 11/Windows Server 2022
Click the start button, and then select **All apps > EPSON > Epson Scan 2 Utility**.
- Windows 10/Windows Server 2016
Click the start button, and then select **EPSON > Epson Scan 2 Utility**.
- Windows 8.1/Windows 8/Windows Server 2012 R2/Windows Server 2012
Enter the application name in the search charm, and then select the displayed icon.
- Windows 7/Windows Server 2008 R2/Windows Server 2008
Click the start button, and then select **All Programs (or Programs) > EPSON > Epson Scan 2 > Epson Scan 2 Utility**.
- Mac OS
Select **Go > Applications > Epson Software > Epson Scan 2 Utility**.

2. Make the following settings on the **Scanner Setting** tab.

Set **Paper Protection** to **On-Low**, **On-Medium** or **On-High**.

To enable this feature, select the level of detection you want to use. See the following table for details on each level.

Level	Explanations
On-Low	Lower the sensitivity to detect the skew of the originals.
On-Medium	Detect the skew of the stapled originals and the skew that On-Low could not detect.

Level	Explanations
On-High	Increase the sensitivity to detect the skew of the originals.

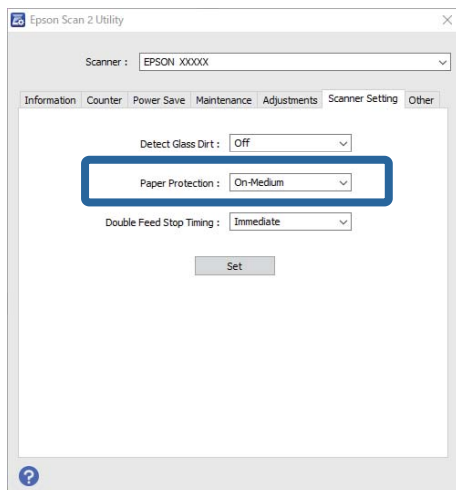

Note:

- This feature may not work correctly depending on the original, the paper feeding conditions, and the level set.
- If false positives occur frequently, try lowering the level.
- If the original is an irregular shape or is scanned at an angle, it may be mistakenly detected as a paper feed error.
- When loading multiple originals, make sure to align the leading edge of the originals. Originals may be misdetected as feeding errors if the edges of the originals are not aligned, even if they are scanned correctly.
- Make sure you align the edge guides with the original to avoid scanning it at an angle.

3. Click **Set** to apply the settings to the scanner.

Setting the Operation when a Double-feed is Detected

Set the timing to stop operations when any double feed of originals is detected.

- Immediate:** Stops immediately after any double feed is detected.
- After Eject:** Scans documents for which a double feed is detected as they are, but scanning of the next document is stopped.

When you are satisfied that there are no problems in the scanned image, you can continue scanning.

The default setting is **Immediate**.

1. Start Epson Scan 2 Utility.
 - Windows 11/Windows Server 2022
Click the start button, and then select **All apps > EPSON > Epson Scan 2 Utility**.
 - Windows 10/Windows Server 2016
Click the start button, and then select **EPSON > Epson Scan 2 Utility**.
 - Windows 8.1/Windows 8/Windows Server 2012 R2/Windows Server 2012
Enter the application name in the search charm, and then select the displayed icon.

- ❑ Windows 7/Windows Server 2008 R2/Windows Server 2008

Click the start button, and then select **All Programs** (or **Programs**) > **EPSON** > **Epson Scan 2** > **Epson Scan 2 Utility**.

- ❑ Mac OS

Select **Go** > **Applications** > **Epson Software** > **Epson Scan 2 Utility**.

2. Make the following settings on the **Scanner Setting** tab.

Set **Double Feed Stop Timing** to **Immediate** or **After Eject**.

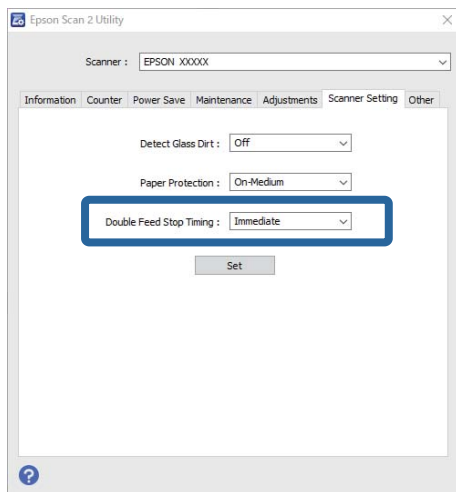

3. Click **Set** to apply the settings to the scanner.

Maintenance

Cleaning Outside the Scanner.	114
Cleaning Inside the Scanner.	114
Replacing the Roller Assembly Kit.	124
Energy Saving.	132
Moving the Scanner.	133
Updating Applications and Firmware.	135

Cleaning Outside the Scanner

Wipe off any stains on the outer case with a dry cloth or a cloth dampened with mild detergent and water.

 **Important:**

- Never use alcohol, thinner, or any corrosive solvent to clean the scanner. Deformation or discoloration may occur.
- Do not let water get inside the product. This could cause a malfunction to occur.
- Never open the scanner case.

1. Press the  button to turn off the scanner.
2. Unplug the AC adapter from the scanner.
3. Clean the outer case with a cloth dampened with mild detergent and water.

Cleaning Inside the Scanner

After using the scanner for a while, paper and room dust on the roller or the glass part inside the scanner may cause paper feed or scanned image quality problems. Clean the inside of the scanner every 5,000 scans.

You can check the latest number of scans in the Epson Scan 2 Utility.

If a surface is stained with a hard-to-remove material, use a genuine Epson cleaning kit to remove stains. Use a small amount of cleaner on the cleaning cloth to remove the stains.

 **Caution:**

Be careful not to get your hands or hair caught in the gears or rollers when cleaning the inside the scanner. This could cause an injury.

 **Important:**

- Never use alcohol, thinner, or any corrosive solvent to clean the scanner. Doing so could cause deformation or discoloration to occur.
- Never spray any liquid or lubricant on the scanner. Damage to equipment or circuits may cause abnormal operations.
- Never open the scanner case.

Note:

- You can set cleaning time notifications and alerts after making a certain number of scans in the Epson Scan 2 Utility. By default, a notification is sent after every 5,000 scans.
- Clean inside the scanner while it is turned on.

1. **Wipe off any stains on the roller.** Open the vertical path cover.

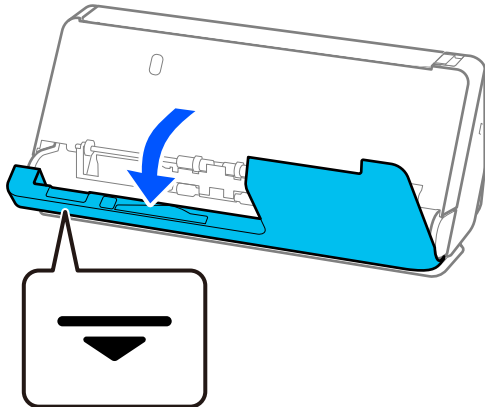

! **Important:**

When opening the vertical path cover, hold the area indicated to avoid touching the antistatic brush. If the brush becomes bent it cannot eliminate static electricity, and this may cause the output originals to stick to each other.

2. Wipe the rollers (4 locations) and the plastic rollers (4 locations). Wipe with a soft, lint-free cloth dampened with a small amount of dedicated cleaner or water.

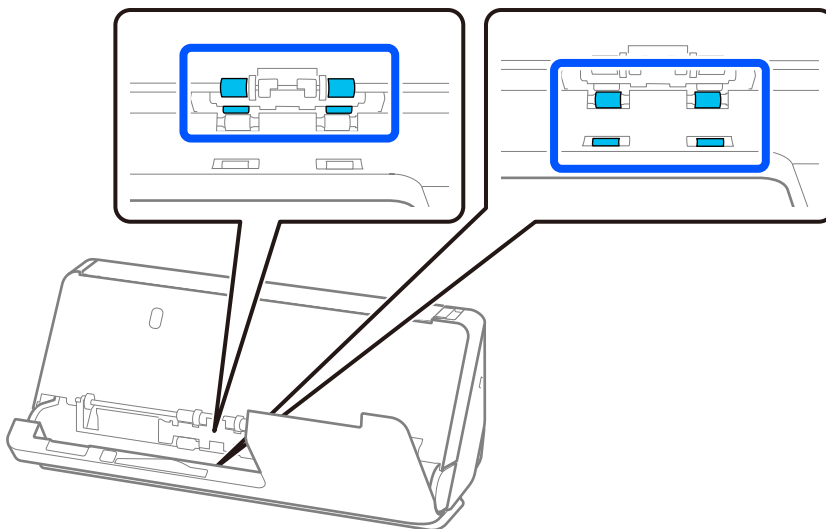

! **Important:**

Be careful not to touch the antistatic brush when wiping the rollers. If the brush becomes bent it cannot eliminate static electricity, and this may cause the output originals to stick to each other.

3. Open the input tray, and pull the lever to open the scanner cover.

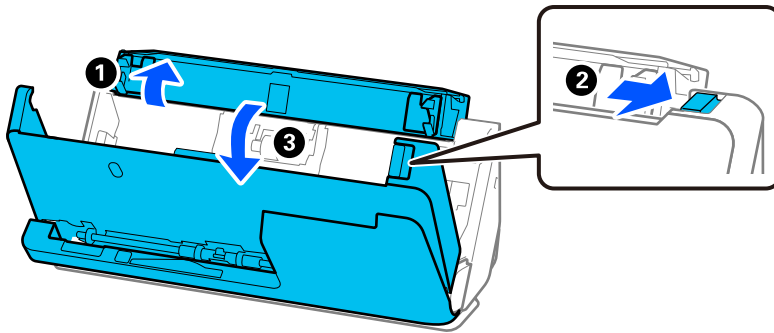

4. Wipe the rollers (8 locations). Wipe with a soft, lint-free cloth dampened with a small amount of dedicated cleaner or water.

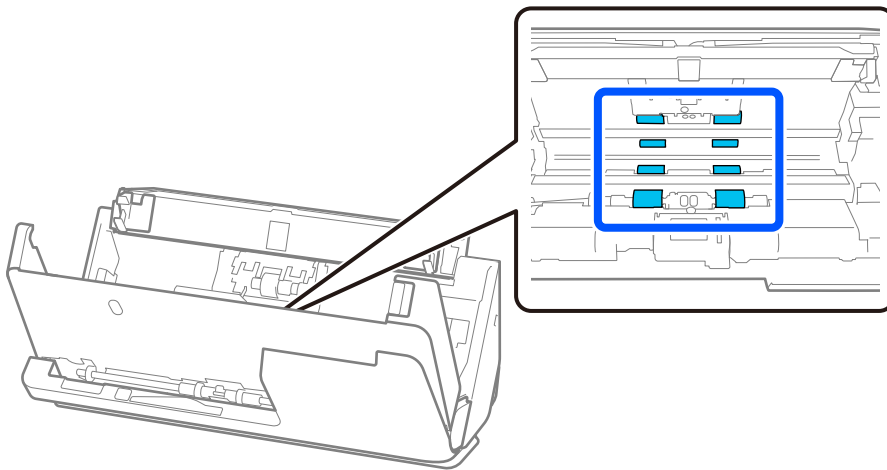

5. Close the scanner cover with both hands. Next, close the vertical path cover and then the input tray, in that order.

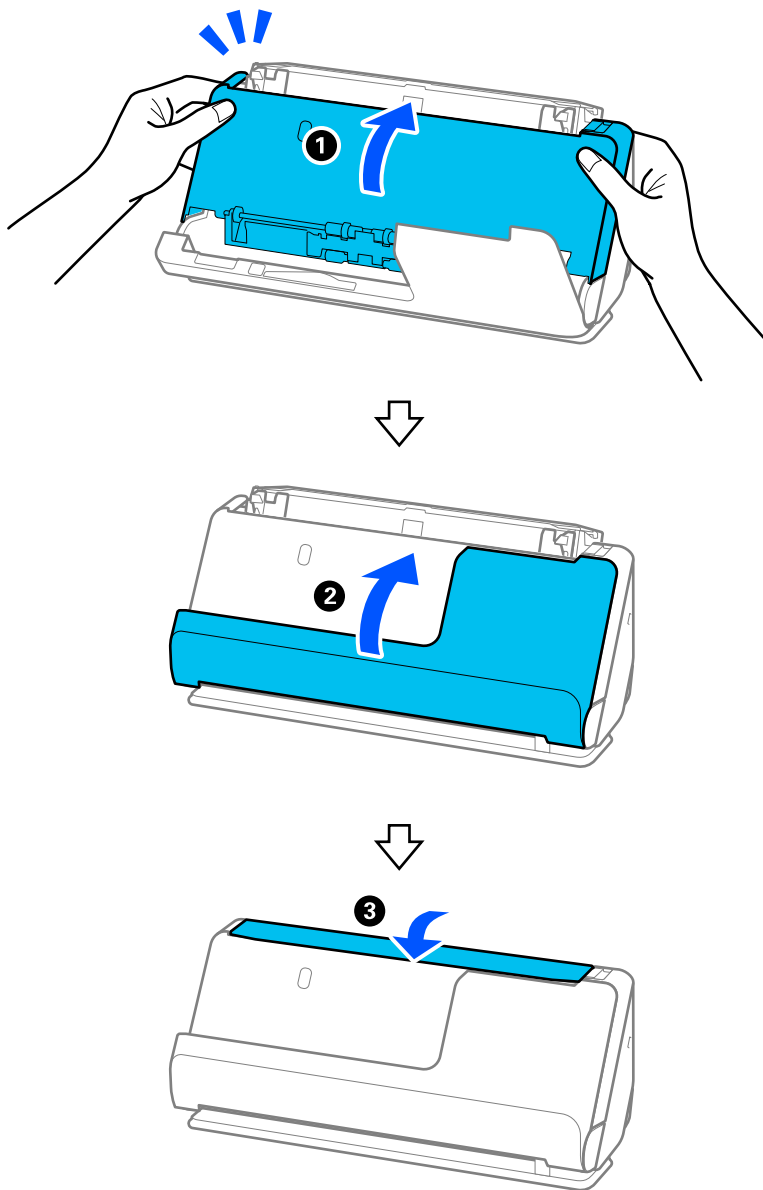

After closing the cover, wait for approximately four seconds before proceeding to the next step.

6. Repeat steps 1 to 5 four times.

The internal rollers rotate approximately one-quarter of a turn each time the cover is closed. Repeat this step until the entire roller is clean.

Note:

If paper dust adheres to the inside of the vertical path cover, wipe it off with a soft, lint-free cloth.

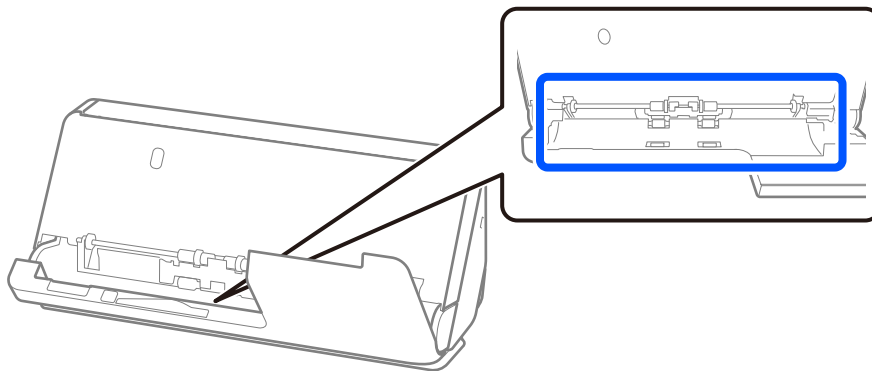

7. **Wipe off any stains inside the scanner.** Open the input tray, and pull the lever to open the scanner cover.

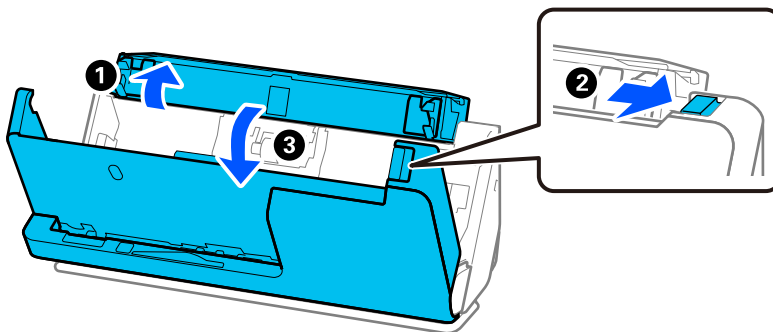

8. Wipe the glass surface inside the scanner cover. Wipe with a dedicated cleaning cloth or a soft, lint-free cloth. If the glass surface is very dirty, wipe with a soft, lint-free cloth dampened with a small amount of dedicated cleaner or water.



Important:

- ❑ Do not place too much force on the glass surface.
- ❑ Do not use a brush or a hard tool. Any scratches on the glass may affect the scan quality.
- ❑ Do not spray cleaner directly onto the glass surface.

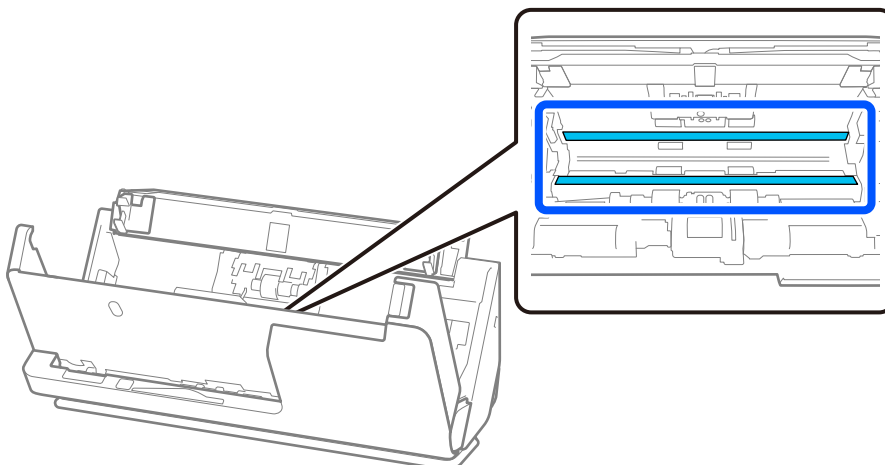

9. Wipe the sensors (4 locations) with a cotton swab.

! *Important:*

Do not use liquid such as a cleaner on a cotton swab.

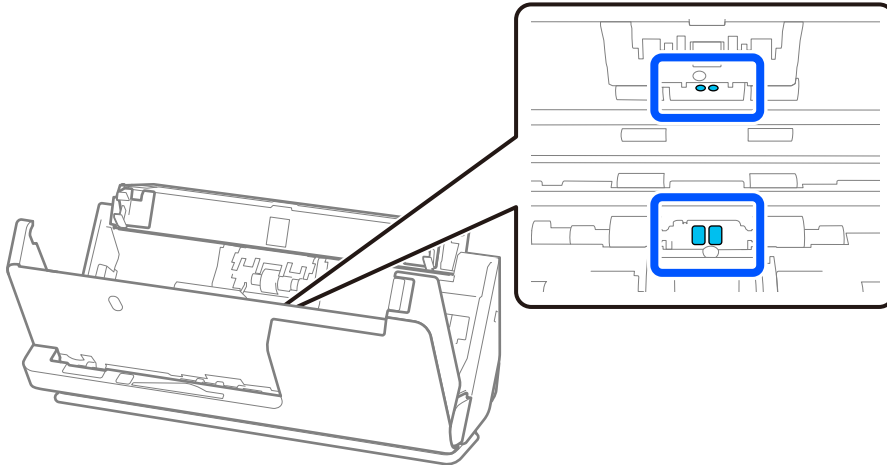

Note:

The ultrasonic sensors (two locations) do not normally require maintenance.

However, if multiple feed errors occur frequently, it is possible that paper dust, room dust, and so on that has accumulated around the ultrasonic sensors is being mistakenly detected as a multiple feed error. If dust has accumulated around the ultrasonic sensors, follow the steps below to clean them.

- Carefully wipe away any large clumps of dust with a cotton swab.*
- Carefully wipe away any smaller particles of dust with a cotton swab dampened with a dedicated cleaner.*
- If you have a blower, such as one used to clean cameras, use it to remove the dust.*

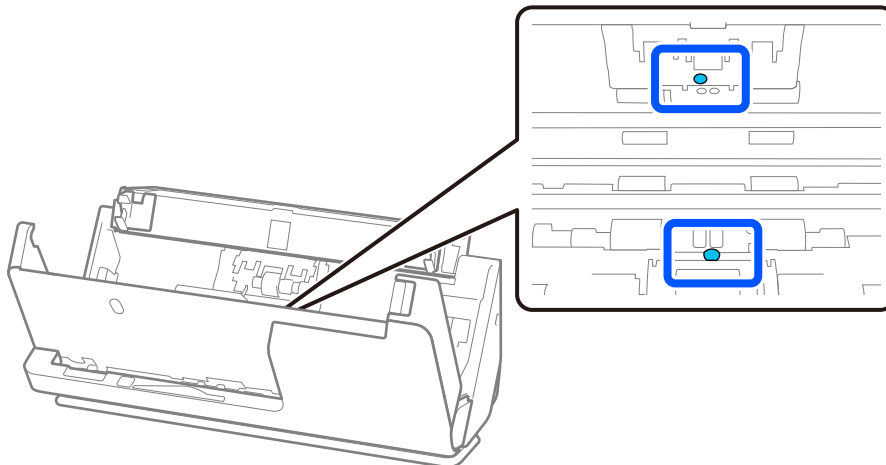

Do not spray cleaner directly onto the ultrasonic sensor. Also, be careful not to insert the cotton swabs too far into the sensor.

10. **Wipe off any stains on the separation roller.** Open the cover, and then remove the separation roller. See “Replacing the Roller Assembly Kit” for more details.

“Replacing the Roller Assembly Kit” on page 124

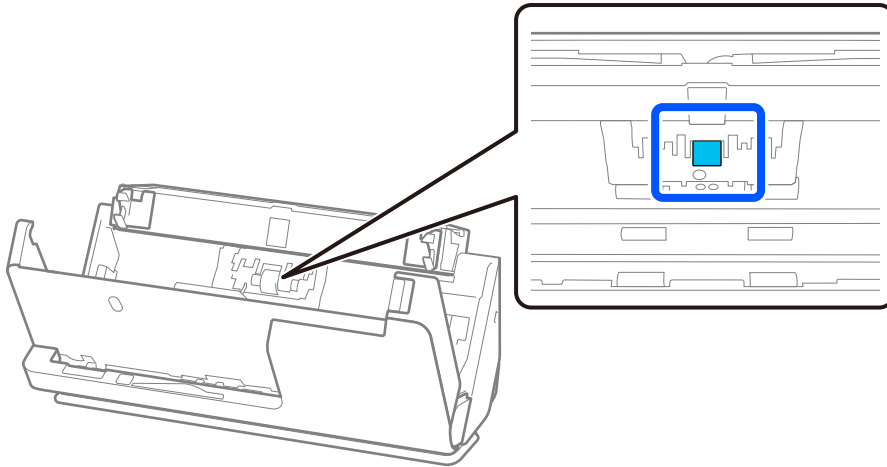

11. Wipe the separation roller. Wipe with a soft, lint-free cloth dampened with a small amount of dedicated cleaner or water.

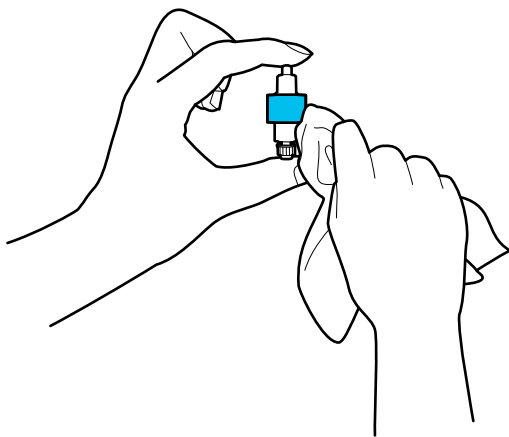

! *Important:*

Use only a moist cloth to clean the roller. Using a dry cloth may damage the surface of the roller.

12. Install the separation roller.
See “Replacing the Roller Assembly Kit” for more details on installing.
13. **Wipe off any stains on the pickup roller.** Open the cover, and then remove the pickup roller.
See “Replacing the Roller Assembly Kit” for more details.

“Replacing the Roller Assembly Kit” on page 124

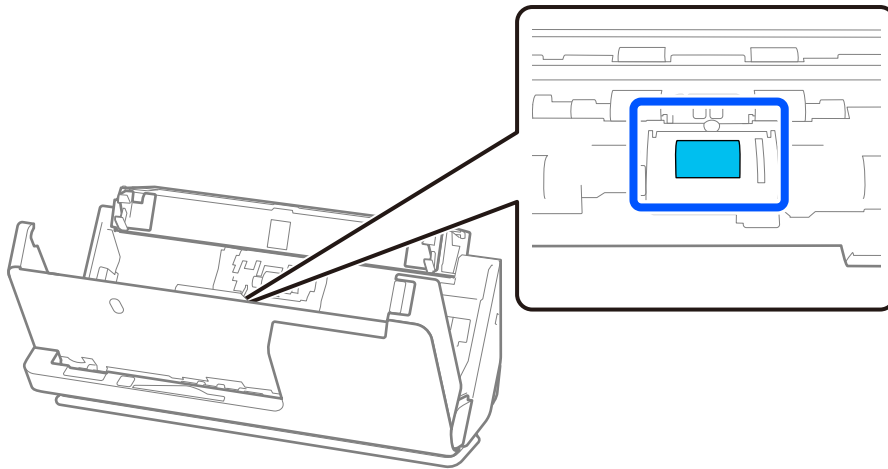

14. Wipe the pickup roller. Wipe with a soft, lint-free cloth dampened with a small amount of dedicated cleaner or water.

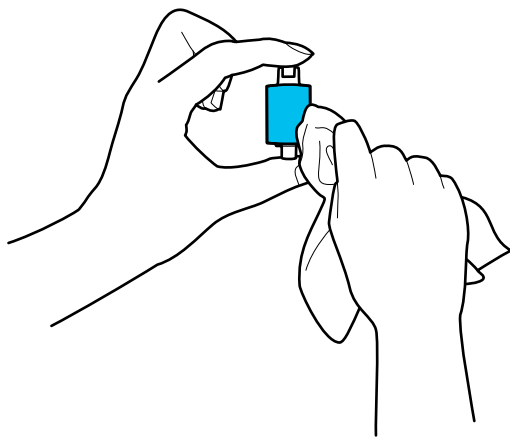

Important:

Use only a moist cloth to clean the roller. Using a dry cloth may damage the surface of the roller.

15. Install the pickup roller.
See “Replacing the Roller Assembly Kit” for more details on installing.

16. Close the scanner cover with both hands. Next, close the input tray.

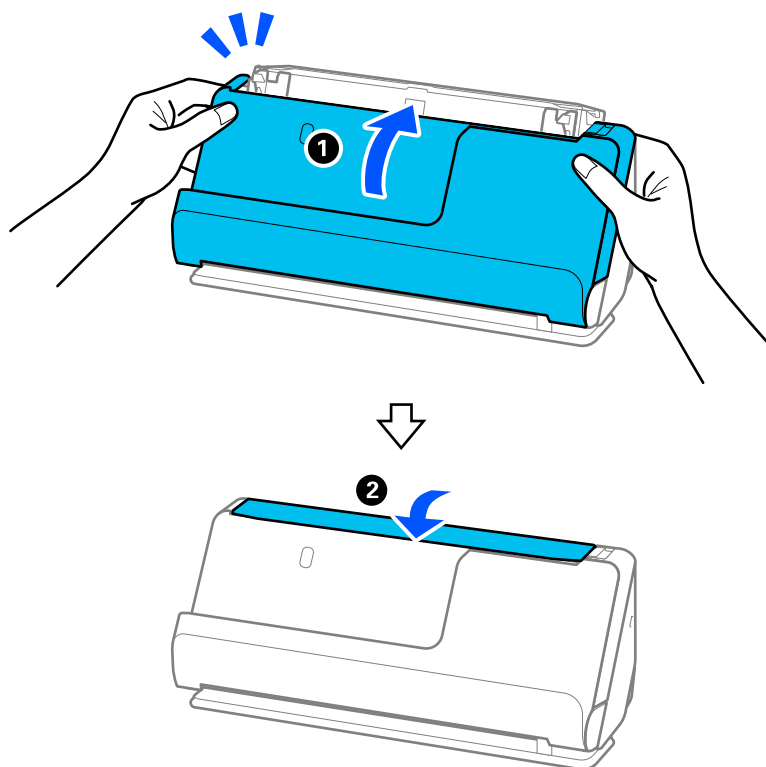

17. Reset the scan number by using the Epson Scan 2 Utility.

Related Information

- ➔ [“Cleaning Kit Codes” on page 28](#)
- ➔ [“Replacing the Roller Assembly Kit” on page 124](#)

Resetting the Number of Scans After Cleaning Inside the Scanner

After performing regular cleaning, reset the number of scans in the Epson Scan 2 Utility.

This section explains how to reset using the Epson Scan 2 Utility.

1. Turn on the scanner.
2. Start Epson Scan 2 Utility.
 - ❑ Windows 11/Windows Server 2022
Click the start button, and then select **All apps > EPSON > Epson Scan 2 Utility**.
 - ❑ Windows 10/Windows Server 2016
Click the start button, and then select **EPSON > Epson Scan 2 Utility**.
 - ❑ Windows 8.1/Windows 8/Windows Server 2012 R2/Windows Server 2012
Start screen > Apps > Epson > Epson Scan 2 Utility.

- ❑ Windows 7/Windows Vista/Windows XP/Windows Server 2008 R2/Windows Server 2008/Windows Server 2003 R2/Windows Server 2003

Click the start button, and then select **All Programs** (or **Programs**) > **EPSON** > **Epson Scan 2** > **Epson Scan 2 Utility**.

- ❑ Mac OS

Select **Go** > **Applications** > **Epson Software** > **Epson Scan 2 Utility**.

3. Click the **Maintenance** tab.
4. Click **Reset** from **Regular Cleaning**.

Note:

You cannot reset when **Regular Cleaning Alert** is not selected.

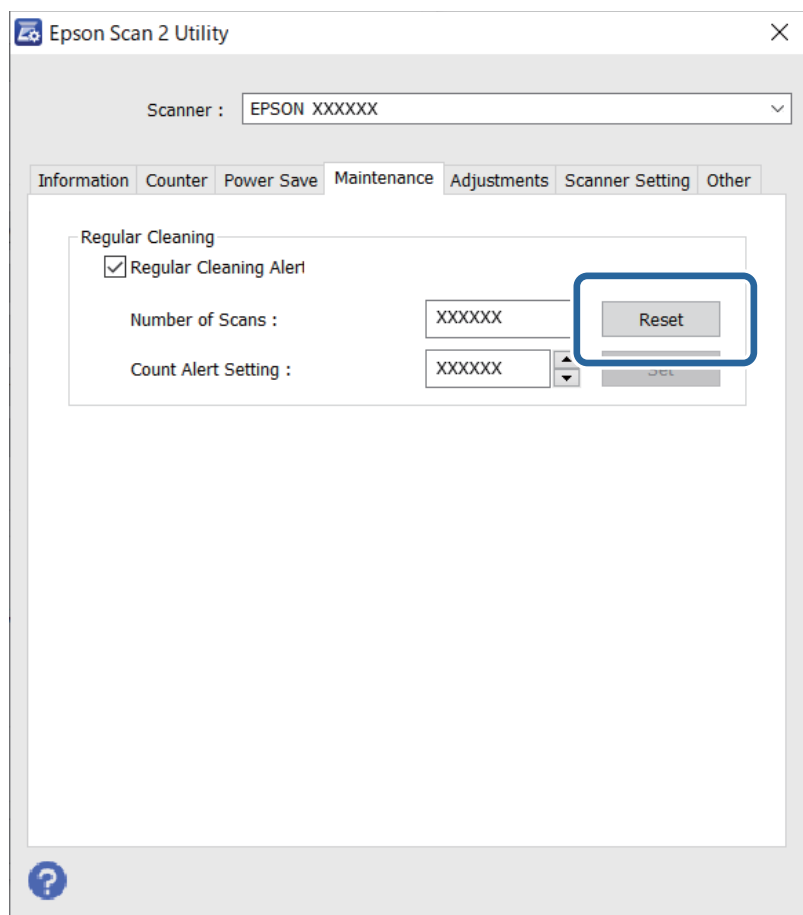

Replacing the Roller Assembly Kit

The roller assembly kit (the pickup roller and the separation roller) needs to be replaced when the number of scans exceeds the life cycle of the rollers. When a replacement message is displayed on your computer screen, follow the steps below to replace it.

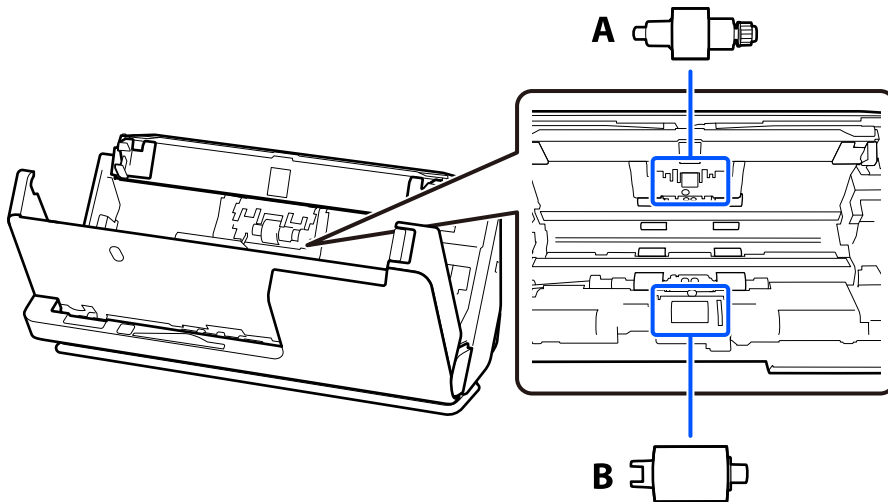

A: Separation Roller, B: Pickup roller

Note:

Replace the roller assembly kit while the scanner is turned on.

1. Open the input tray, and pull the lever to open the scanner cover.

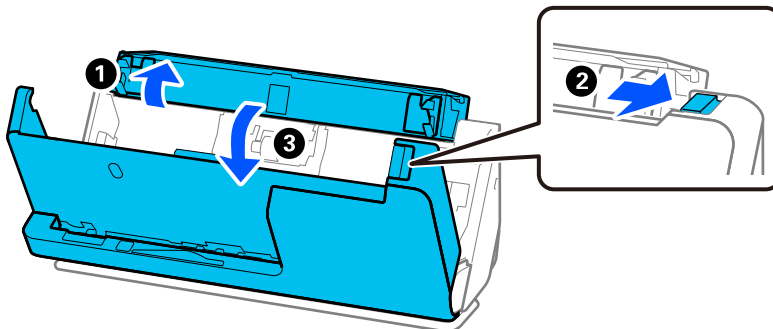

2. Remove the separation roller cover as shown.

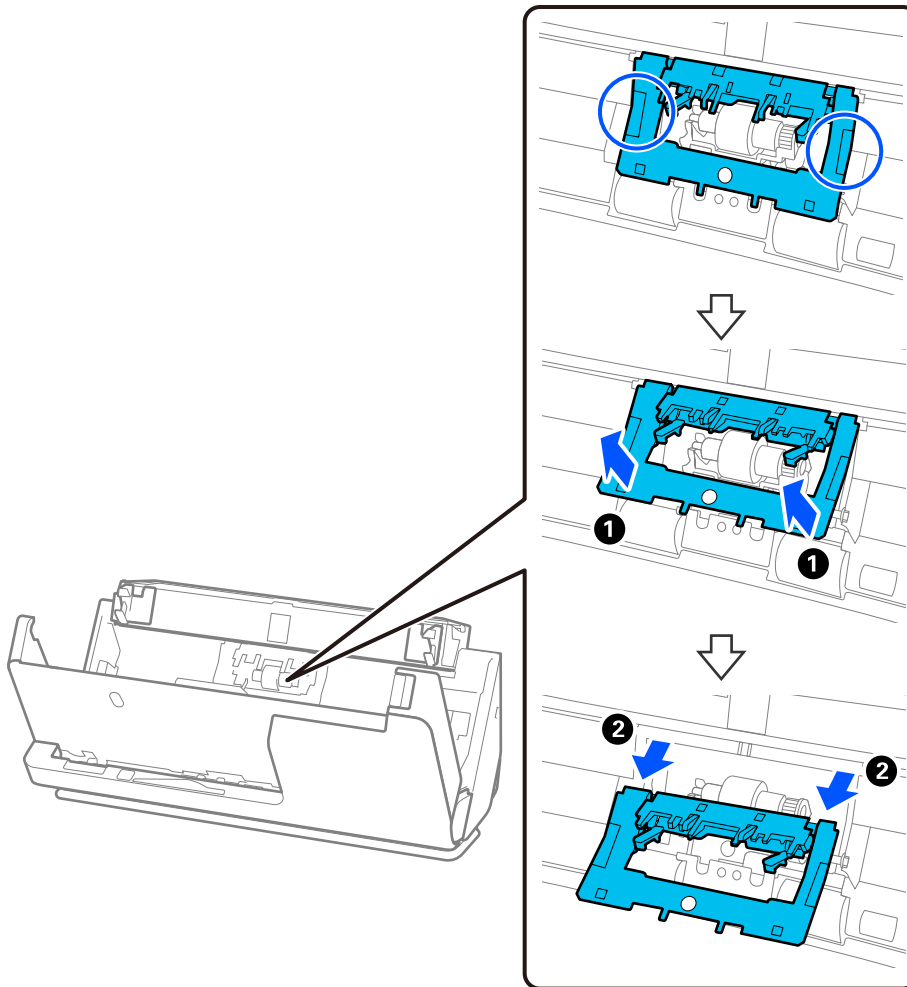

3. Remove the separation roller as shown.

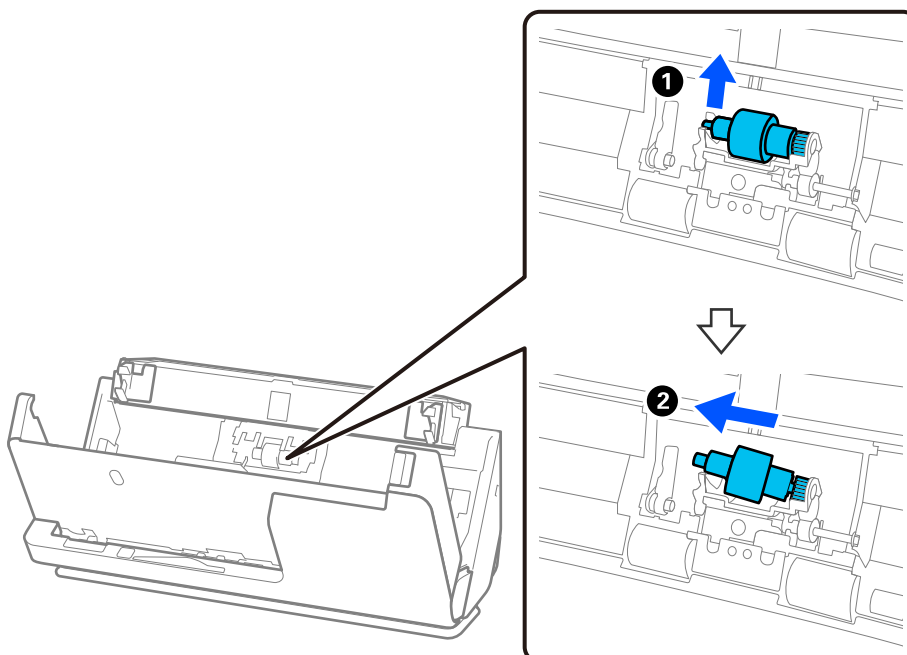

! *Important:*

Do not pull out the separation roller forcibly. This could damage the inside of the scanner.

4. Attach the new separation roller as shown. Insert the axis of the separation roller into the hole on the right side, and then lower the separation roller.

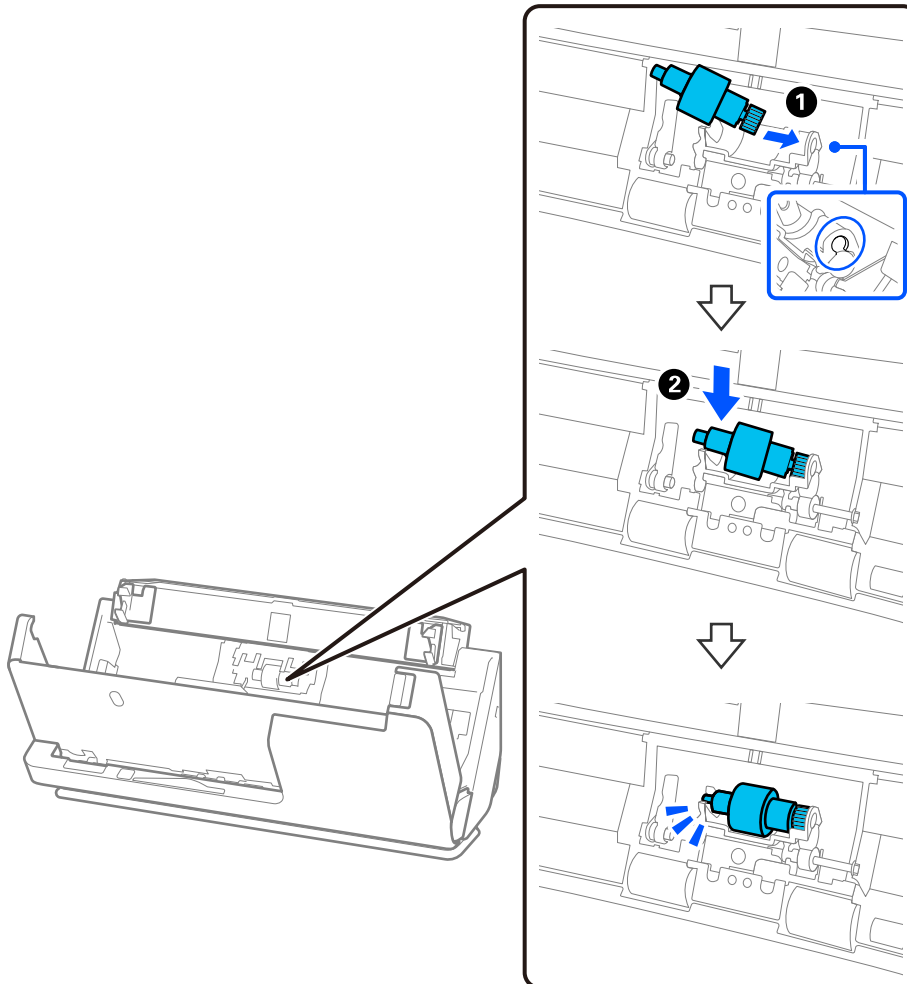

5. Attach the separation roller cover as shown. Insert the axis on the upper side of the cover into the grooves, and then close the cover firmly.

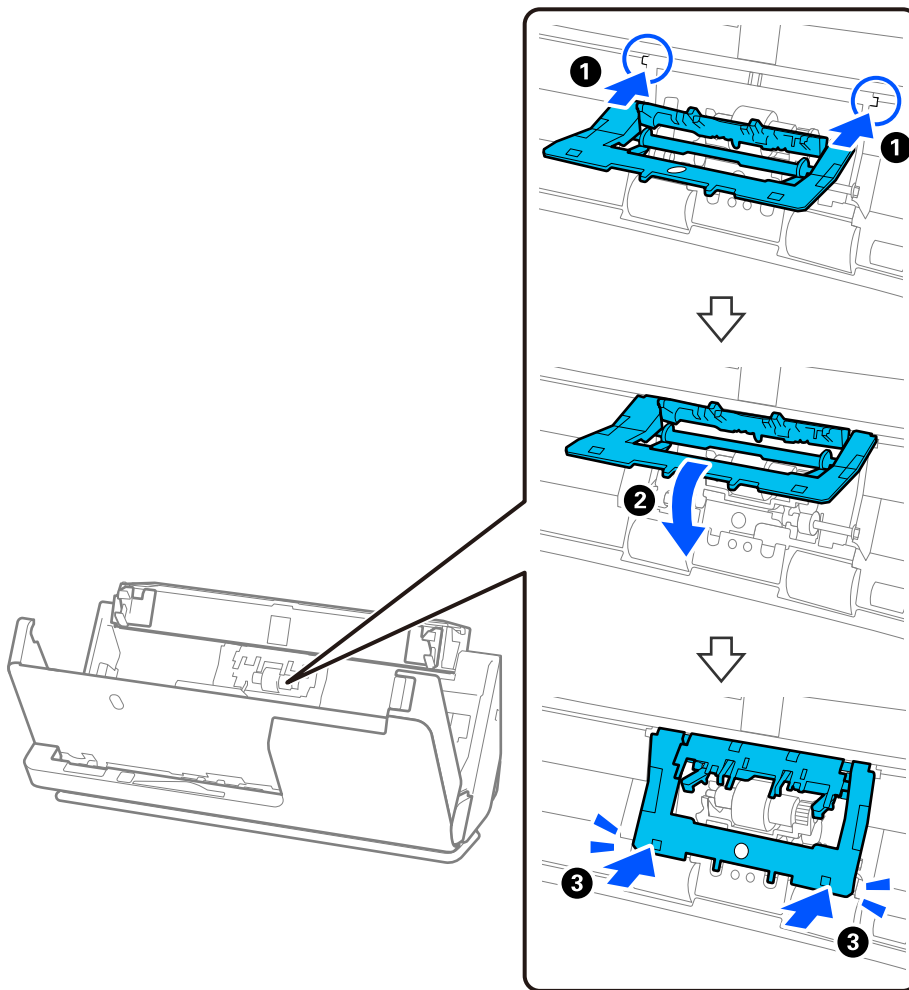

! *Important:*

- Make sure the cover is closed correctly.*
- If the cover is hard to close, make sure the separation rollers are installed correctly.*
- Do not install the cover while it is raised.*

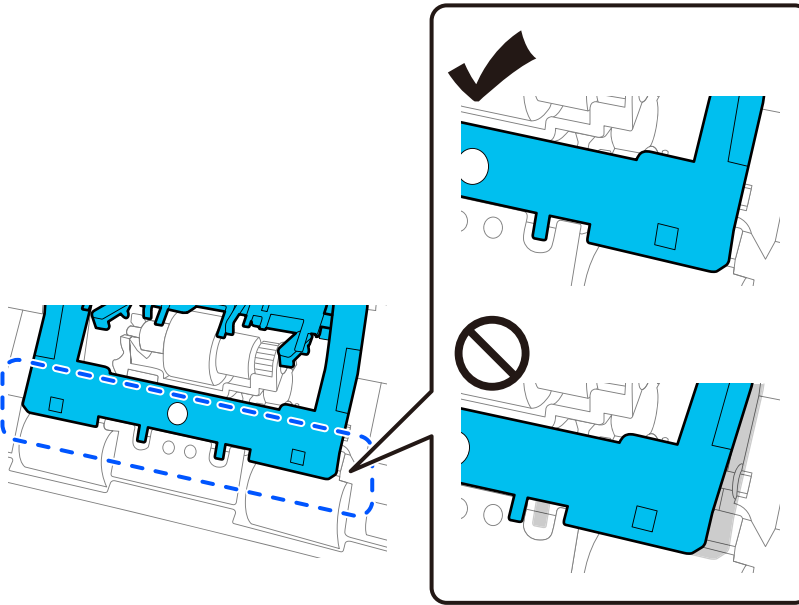

6. Open the cover of the pickup roller.

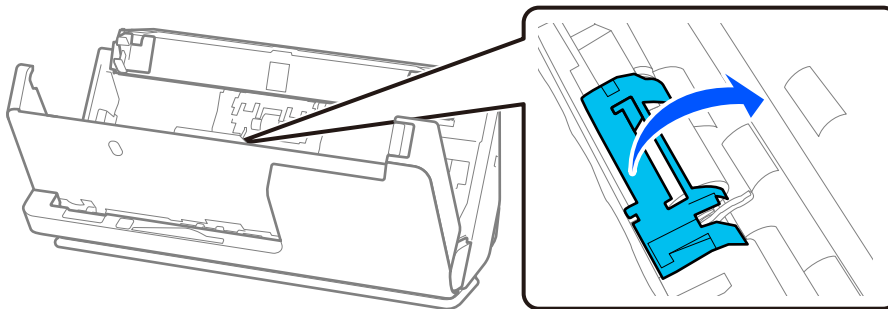

7. Remove the pickup roller as shown.

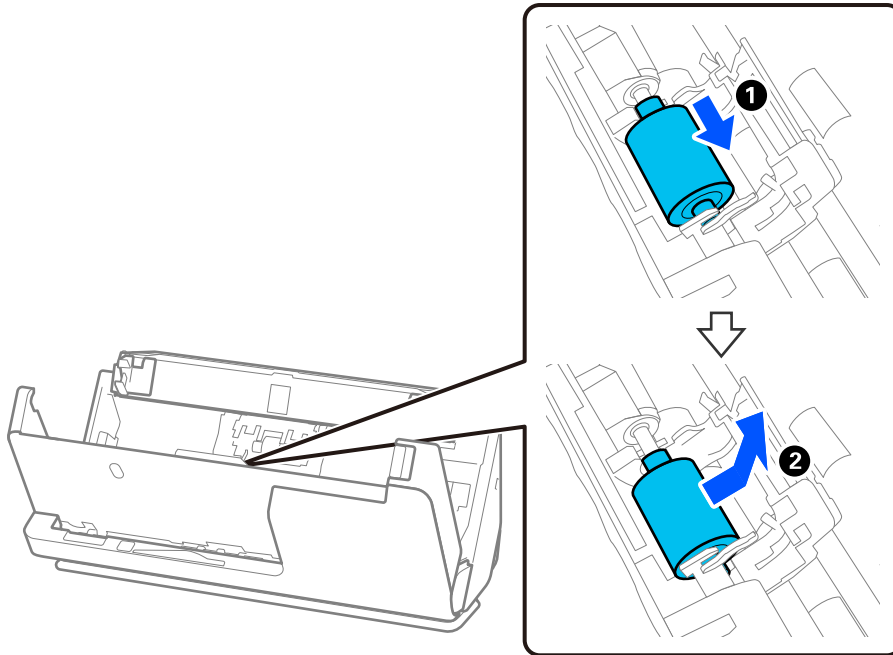

8. Attach the new pickup roller as shown. Insert the indentations at the ends of the pickup roller onto the axis on the scanner, lower the pickup roller, and then slide it to the back.

Make sure the indentations are aligned.

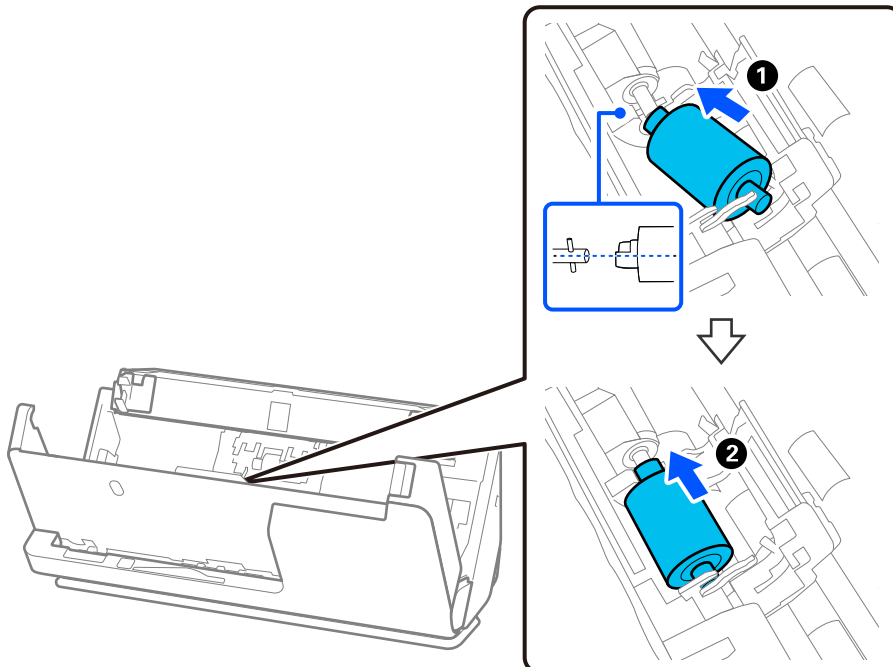

9. Close the pickup roller cover.

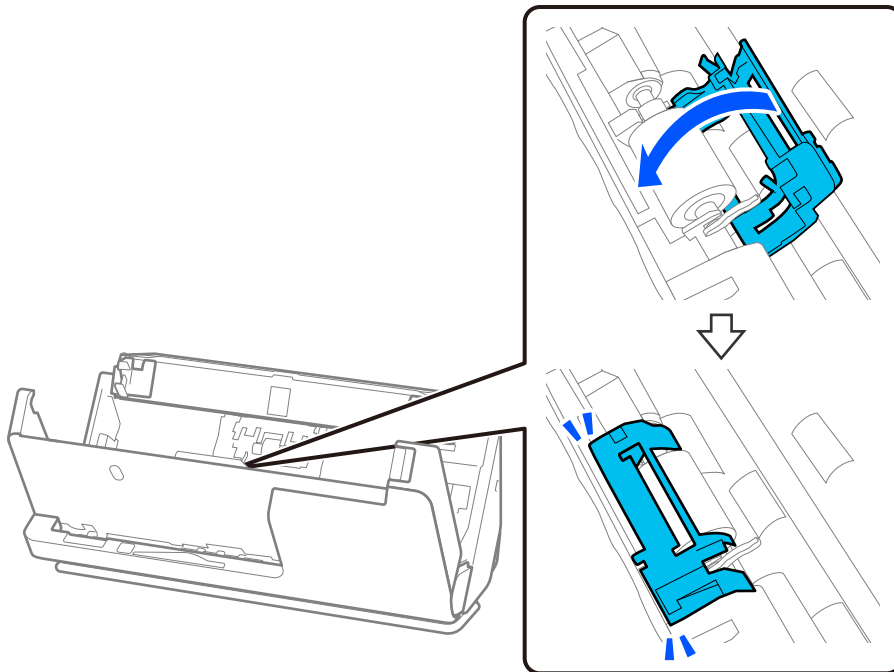

Important:

If the cover is hard to close, make sure the pickup rollers are installed correctly, and that the protruding parts are aligned.

10. Close the scanner cover with both hands. Next, close the input tray.

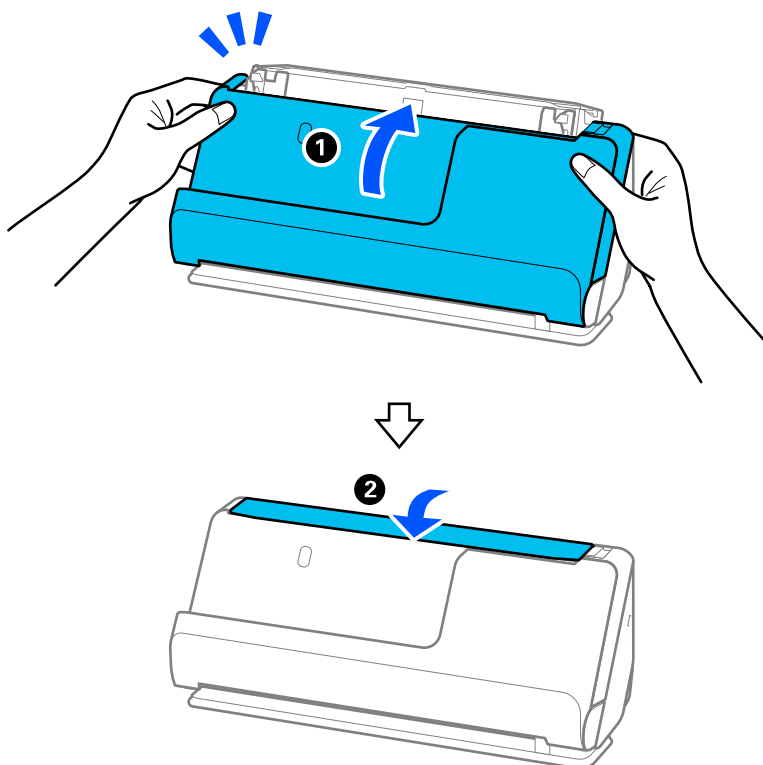

11. Reset the scan number by using the Epson Scan 2 Utility.

Note:

Dispose of the pickup roller and the separation roller following the rules and regulations of your local authority. Do not disassemble them.

Related Information

➔ [“Roller Assembly Kit Codes” on page 27](#)

Resetting the Number of Scans After Replacing the Rollers

Reset the number of scans using Epson Scan 2 Utility after replacing the roller assembly kit.

This section explains how to reset using the Epson Scan 2 Utility.

1. Turn on the scanner.
2. Start Epson Scan 2 Utility.
 - ❑ Windows 11/Windows Server 2022
Click the start button, and then select **All apps > EPSON > Epson Scan 2 > Epson Scan 2 Utility**.
 - ❑ Windows 10/Windows Server 2016/Windows Server 2019
Click the start button, and then select **EPSON > Epson Scan 2 Utility**.
 - ❑ Windows 8.1/Windows 8/Windows Server 2012 R2/Windows Server 2012
Start screen > Apps > Epson > Epson Scan 2 Utility.
 - ❑ Windows 7/Windows Server 2008 R2/Windows Server 2008
Click the start button, and then select **All Programs (or Programs) > EPSON > Epson Scan 2 > Epson Scan 2 Utility**.
 - ❑ Mac OS
Select **Go > Applications > Epson Software > Epson Scan 2 Utility**.
3. Click the **Counter** tab.

4. Click **Reset** from **Roller Assembly Kit**.

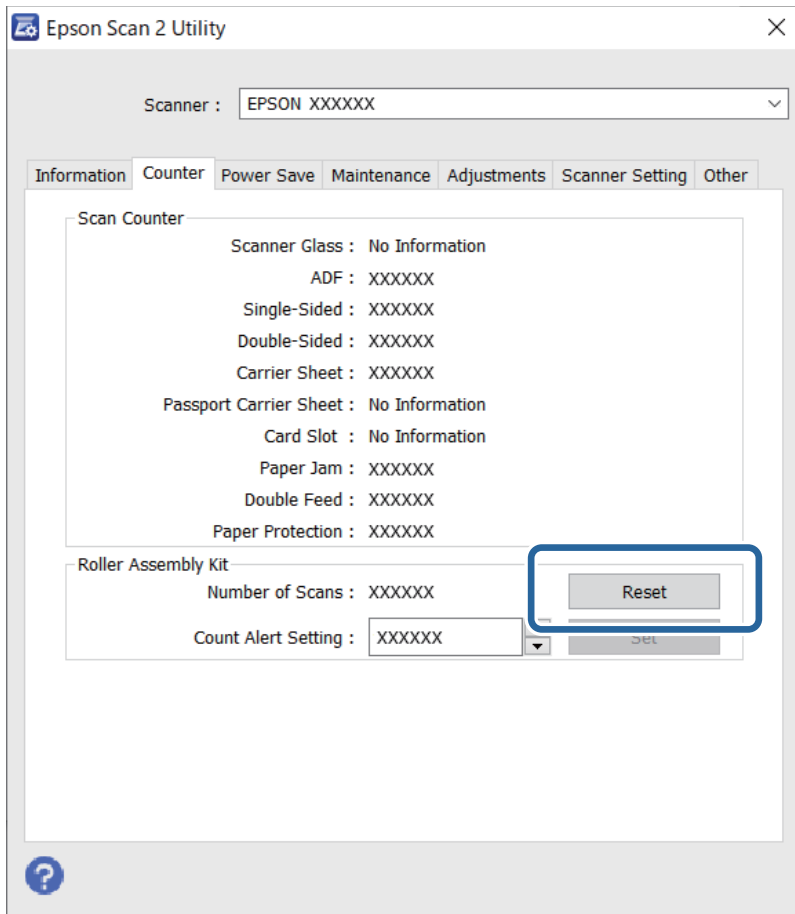

Energy Saving

You can adjust the time before power management is applied. Any increase will affect the product's energy efficiency. Please consider the environment before making any changes.

1. Start Epson Scan 2 Utility.
 - ❑ Windows 11/Windows Server 2022
Click the start button, and then select **All apps > EPSON > Epson Scan 2 Utility**.
 - ❑ Windows 10/Windows Server 2019/Windows Server 2016
Click the start button, and then select **EPSON > Epson Scan 2 Utility**.
 - ❑ Windows 8.1/Windows 8/Windows Server 2012 R2/Windows Server 2012
Start screen > Apps > Epson > Epson Scan 2 Utility.
 - ❑ Windows 7/Windows Server 2008/Windows Server 2008 R2
Click the start button, and then select **All Programs (or Programs) > EPSON > Epson Scan 2 > Epson Scan 2 Utility**.
 - ❑ Mac OS
Select **Go > Applications > Epson Software > Epson Scan 2 Utility**.

2. Click the **Power Save** tab.
3. Set the **Power Off Timer (minutes)** or **Power Off If Disconnected**, and then click **Set**.

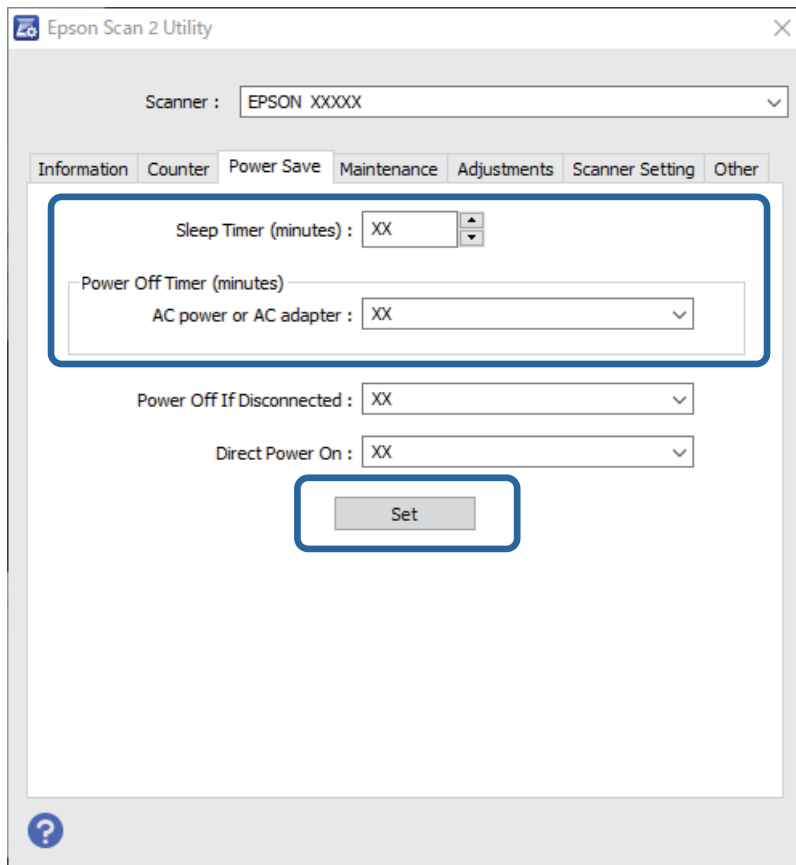

Moving the Scanner

Transporting the Scanner

When you need to transport the scanner, follow the steps below to pack the scanner.

1. Press the  button to turn off the scanner.
2. Unplug the AC adapter.
3. Remove the cables and the devices.

4. Store the input tray extension, and close the input tray.
When the output support is extended, retract it completely.

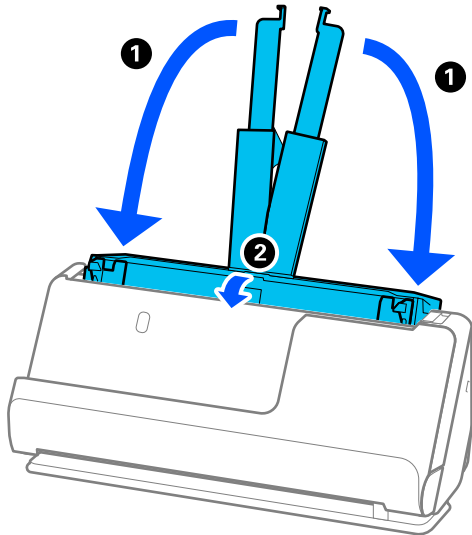

5. Set the scanner in the vertical path position.

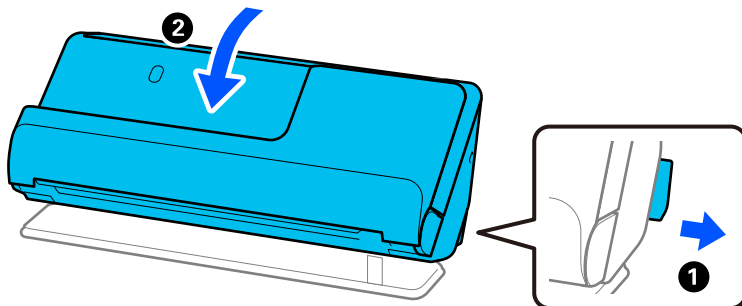

6. Attach the protective materials that came with the scanner, and then repack it in its original box or a similar sturdy box.

How to Carry the Scanner

When carrying the scanner, hold it as shown in the following figure.

When carrying with one hand

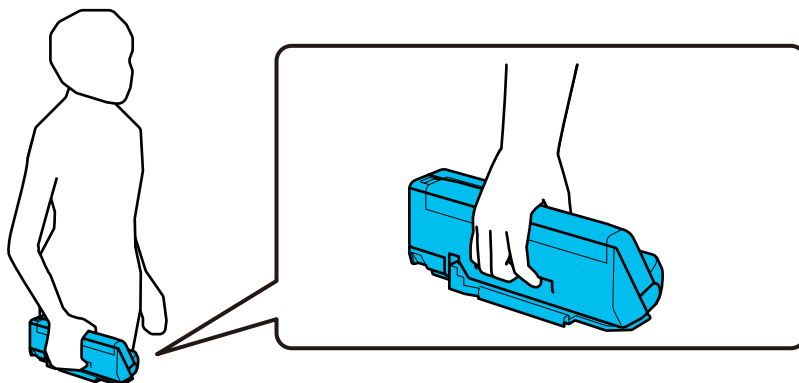

When carrying with both hands

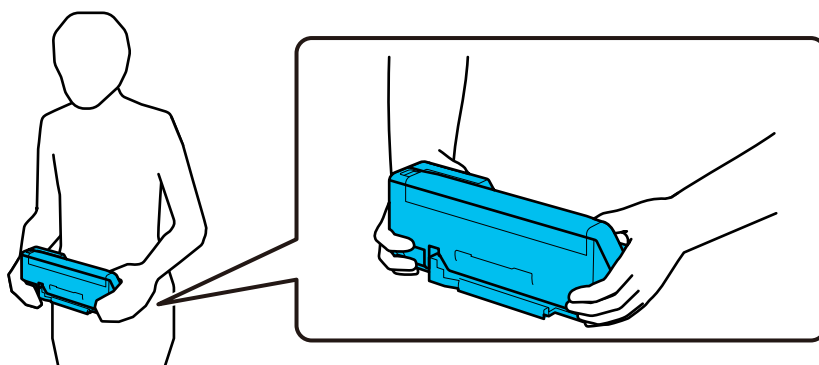

Note:

When carrying the scanner, disconnect all cables, stow the tray support, and place the scanner in the vertical path position.

[“Transporting the Scanner” on page 133](#)

Updating Applications and Firmware

You may be able to clear certain problems and improve or add functions by updating the applications and the firmware. Make sure you use the latest version of the applications and firmware.

! Important:

- Do not turn off the computer or the scanner while updating.

1. Make sure that the scanner and the computer are connected, and the computer is connected to the internet.
2. Start EPSON Software Updater, and update the applications or the firmware.

Note:

Windows Server operating systems are not supported.

- Windows 11

Click the start button, and then select **All apps > Epson Software > EPSON Software Updater**.

Windows 10

Click the start button, and then select **Epson Software > EPSON Software Updater**.

Windows 8.1/Windows 8

Enter the application name in the search charm, and then select the displayed icon.

Windows 7

Click the start button, and then select **All Programs** or **Programs > Epson Software > EPSON Software Updater**.

Mac OS

Select **Finder > Go > Applications > Epson Software > EPSON Software Updater**.

Note:

If you cannot find the application you want to update in the list, you cannot update using the EPSON Software Updater. Check for the latest versions of the applications on your local Epson website.

<http://www.epson.com>

Updating Firmware without Connecting to the Internet

You can download the device's firmware from Epson website on the computer, and then connect the device and the computer by USB cable to update the firmware.

Note:

Before updating, make sure that the scanner driver Epson Scan 2 is installed on your computer. If Epson Scan 2 is not installed, install it again.

1. Check the Epson website for the latest firmware update releases.

<http://www.epson.com>

- If there is the firmware for your scanner, download it and go to the next step.
- If there is no firmware information on the website, you are already using the latest firmware.

2. Connect the computer that contains the downloaded firmware to the scanner by USB cable.

3. Double-click the downloaded .exe file.

Epson Firmware Updater starts.

4. Follow the on-screen instructions.

Solving Problems

Problems with the Scanner.	138
Problems Starting Scanning.	138
Paper Feeding Problems.	141
Scanned Image Problems.	150
Document Capture Pro Problems.	154
Uninstalling and Installing Applications.	155

Problems with the Scanner

Scanner Lights Indicate an Error

Check the following if the scanner lights indicate an error.

- Make sure there are no originals jammed in the scanner.
- If multiple originals are fed, open the scanner cover and remove the originals. Next, close the scanner cover.
- This product uses two different positions for scanning, depending on the original being scanned. Check the link to see which position is appropriate for your original.
[“Combinations of Originals and Scanner Position” on page 40](#)
- Make sure the scanner cover is closed.
- Make sure the scanner is connected to your computer properly.
- Make sure Epson Scan 2 is installed correctly.
- If the firmware update fails and the scanner enters recovery mode, update the firmware again using a USB connection.
- Restart the scanner. If the problem is not solved, the product may be malfunctioning. Also, the light source in the scanner unit may need to be replaced. Contact your dealer.

Related Information

- ➔ [“Error Indicators” on page 23](#)
- ➔ [“Paper Jams, Paper Feed Errors, and Document Protection Issues Occur Frequently” on page 148](#)

The Scanner Does Not Turn On

- Make sure the AC adapter is securely connected to the scanner and an electrical outlet.
- Check that the electrical outlet is working. Plug another device into the electrical outlet and check that you can turn the power on.

Problems Starting Scanning

Cannot Start Scanning from Computer

Checking the Connection Status (Windows)

Use the Epson Scan 2 Utility to check the connection status.

Note:

Epson Scan 2 Utility is an application supplied with the scanner software.

1. Start the Epson Scan 2 Utility.
 - ❑ Windows 11
Click the start button, and then select **All apps > EPSON > Epson Scan 2 Utility**.
 - ❑ Windows 10
Click the start button, and then select **EPSON > Epson Scan 2 Utility**.
 - ❑ Windows 8.1/Windows 8
Enter the application name in the search charm, and then select the displayed icon.
 - ❑ Windows 7
Click the start button, and then select **All Programs or Programs > EPSON > Epson Scan 2 > Epson Scan 2 Utility**.
2. On the **Epson Scan 2 Utility** screen, open the **Scanner** list, and then click **Settings** to open the **Scanner Settings** screen.
If the **Scanner Settings** screen is already displayed instead of the **Epson Scan 2 Utility** screen, go to the next.
3. If the scanner is not displayed on the **Scanner Settings** screen, your scanner is not detected.
Click **Add**, and then add your scanner on the **Add Network Scanner** screen.



If you cannot search for the scanner or cannot scan even if the correct scanner is selected, see the related information.

Checking the Connection Status (Mac OS)

Use Epson Scan 2 Utility to check the connection status.

Note:

Epson Scan 2 Utility is an application supplied with the scanner software.

1. Start the Epson Scan 2 Utility.
Select **Go > Applications > Epson Software > Epson Scan 2 Utility**.
2. On the **Epson Scan 2 Utility** screen, open the **Scanner** list, and then click **Settings** to open the **Scanner Settings** screen.
If the **Scanner Settings** screen is already displayed instead of the **Epson Scan 2 Utility** screen, go to the next
3. If the scanner is not displayed on the **Scanner Settings** screen, your scanner is not detected.
Click the  icon, and then allow the software to make changes.
4. Click the  icon, and then add your scanner on the **Add Network Scanner** screen.

If you cannot search for the scanner or cannot scan even if the correct scanner is selected, see the related information.

The Scanner Cannot Connect by USB

The following causes can be considered.

■ **The USB cable is not plugged into the electrical outlet correctly.**

Solutions

Connect the USB cable securely to the scanner and the computer.

■ **There is a problem with the USB hub.**

Solutions

If you are using a USB hub, try to connect the scanner directly to the computer.

■ **There is a problem with the USB cable or the USB inlet.**

Solutions

If the USB cable cannot be recognized, change the port, or change the USB cable.

■ **The scanner is off.**

Solutions

Make sure the scanner is turned on.

Also, wait until the status light stops flashing indicating that the scanner is ready to scan.

Cannot Scan Even Though a Connection has been Correctly Established

■ **Required applications are not installed on your computer.**

Solutions

Make sure the following applications are installed:

- Document Capture Pro (Windows) or Document Capture (Mac OS)
- Epson Scan 2

If the applications are not installed, install them again.

■ **Job is not assigned to the scanner button.**

Solutions

Check that the job is correctly assigned to the scanner button in Document Capture Pro (Windows) or Document Capture (Mac OS).

■ **If you are using any TWAIN-compliant programs, the correct scanner is not selected as the source setting. (Windows)**

Solutions

Make sure that you select the correct scanner from your programs list.

Paper Feeding Problems

Multiple Originals Are Fed (Double Feed)

Check the following when a double feed occurs.

- ❑ If the jammed original is inside the scanner, open the scanner cover or vertical path cover and remove the original.
- ❑ Check the scanned image, and then scan the originals again if necessary.

Make sure the scanner is in the correct scanner position for the original.

- ❑ This product uses two different positions for scanning, depending on the original being scanned. Check the link to see which position is appropriate for your original.

[“Combinations of Originals and Scanner Position” on page 40](#)

- ❑ When scanning multiple standard-size originals, scan in the vertical path position.

If the scanner is in the straight path position, pull the lever to tilt the scanner forward to place it in the vertical path position.

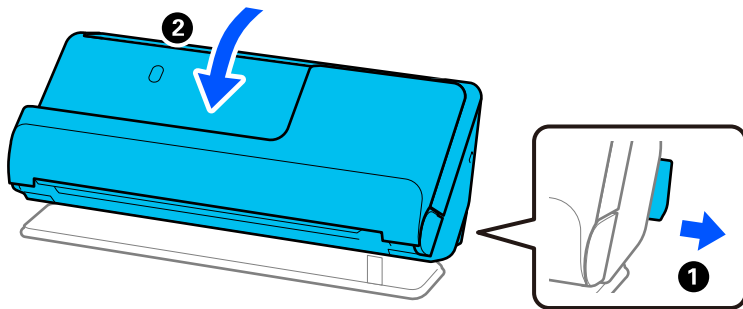

- ❑ When scanning in the straight path position, load only one original at a time.

If the scanner is in the vertical path position, pull the lever to tilt the scanner backward to the straight path position.

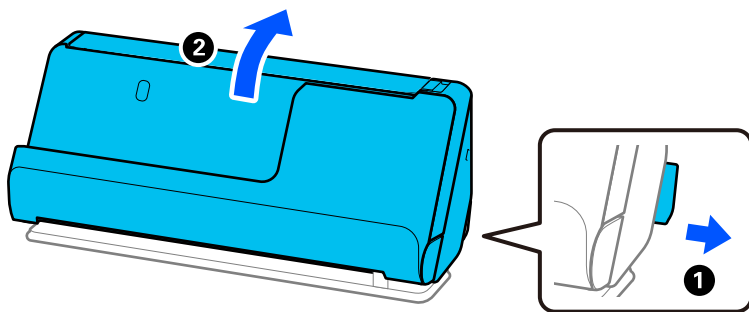

If multiple originals are fed frequently, try the following.

- ❑ If you load unsupported originals, the scanner may feed multiple originals at a time.
- ❑ Reduce the number of originals being placed at a time.
- ❑ Enable Slow Mode (▶▶) to slow down the paper feeding speed.

- ❑ Use **Automatic Feeding Mode**, and scan originals one by one.

When you are using Document Capture Pro, you can open the Epson Scan 2 screen by pressing the **Detailed Settings** button on the **Scan Settings** screen.

- ❑ Clean the rollers inside the scanner.

[“Cleaning Inside the Scanner” on page 114](#)

- ❑ Check the number of sheets scanned by the pickup roller. If the number of scans exceeds the pickup roller's service life (50,000 sheets), replace the roller assembly kit with a new one.

Even if the number of scans does not exceed the pickup roller's service life, we recommend replacing the roller assembly kit with a new one if the surface of the roller is worn out.

[“Replacing the Roller Assembly Kit” on page 124](#)

Note:

You can check the number of sheets scanned by the pickup roller in the Epson Scan 2 Utility. Start the Epson Scan 2 Utility, click on the **Counter** tab, and then check the **Number of Scans in Roller Assembly Kit**.

- ❑ If multiple feed errors occur frequently, it is possible that paper dust, room dust, and so on that has accumulated around the ultrasonic sensors is being mistakenly detected as a multiple feed error. If dust has accumulated around the ultrasonic sensors, clean the ultrasonic sensors.

Related Information

- ➔ [“Scanning in Automatic Feeding Mode” on page 104](#)
- ➔ [“Cleaning Inside the Scanner” on page 114](#)
- ➔ [“Removing Jammed Originals from the Scanner” on page 142](#)

Removing Jammed Originals from the Scanner

If an original is jammed in the scanner, clear the jam according to the procedure for the scanner position.

Note:

If you change the scanner position while scanning, the original will get jammed. Do not change the scanner position while scanning.

Related Information

- ➔ [“Multiple Originals Are Fed \(Double Feed\)” on page 141](#)
- ➔ [“Paper Jams, Paper Feed Errors, and Document Protection Issues Occur Frequently” on page 148](#)
- ➔ [“Paper Protection Does not Work Correctly” on page 149](#)

For the Vertical Path Position

1. Remove all originals remaining in the input tray.

2. Open the vertical path cover.

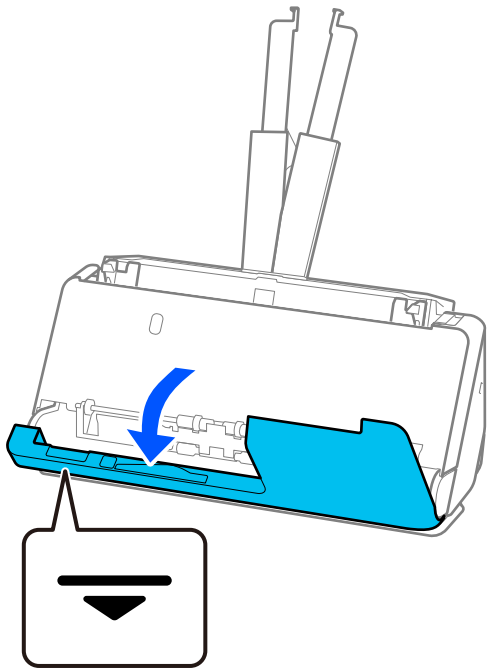

3. Pull the lever to open the scanner cover.

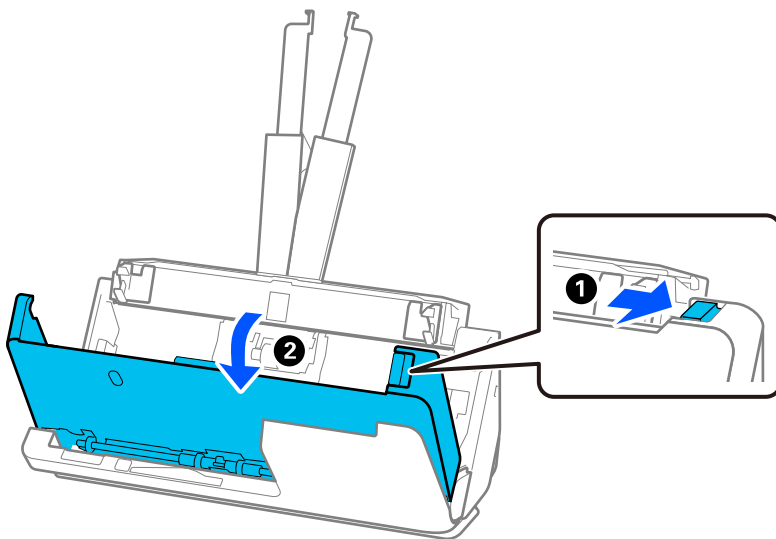

- Carefully remove any jammed originals.

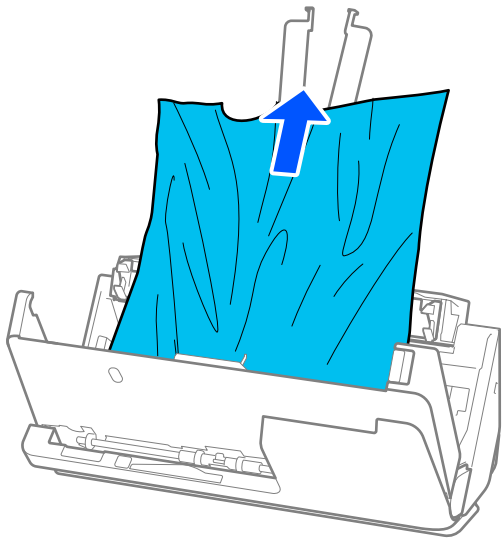

- If you cannot pull originals straight up, carefully pull out any jammed originals from the output tray in the direction of the arrow.

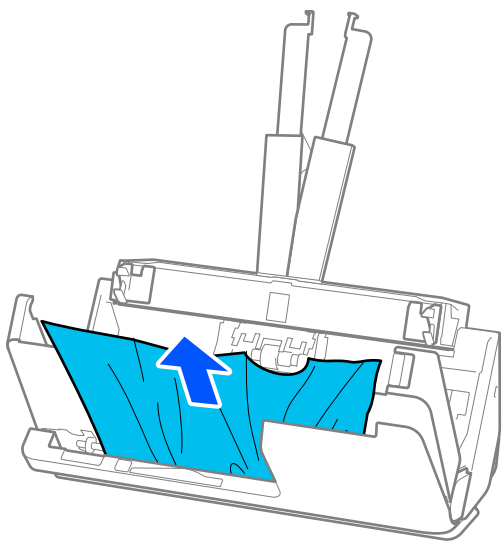

Important:

Make sure there is no paper inside the scanner.

6. Close the scanner cover with both hands. Next, close the vertical path cover.

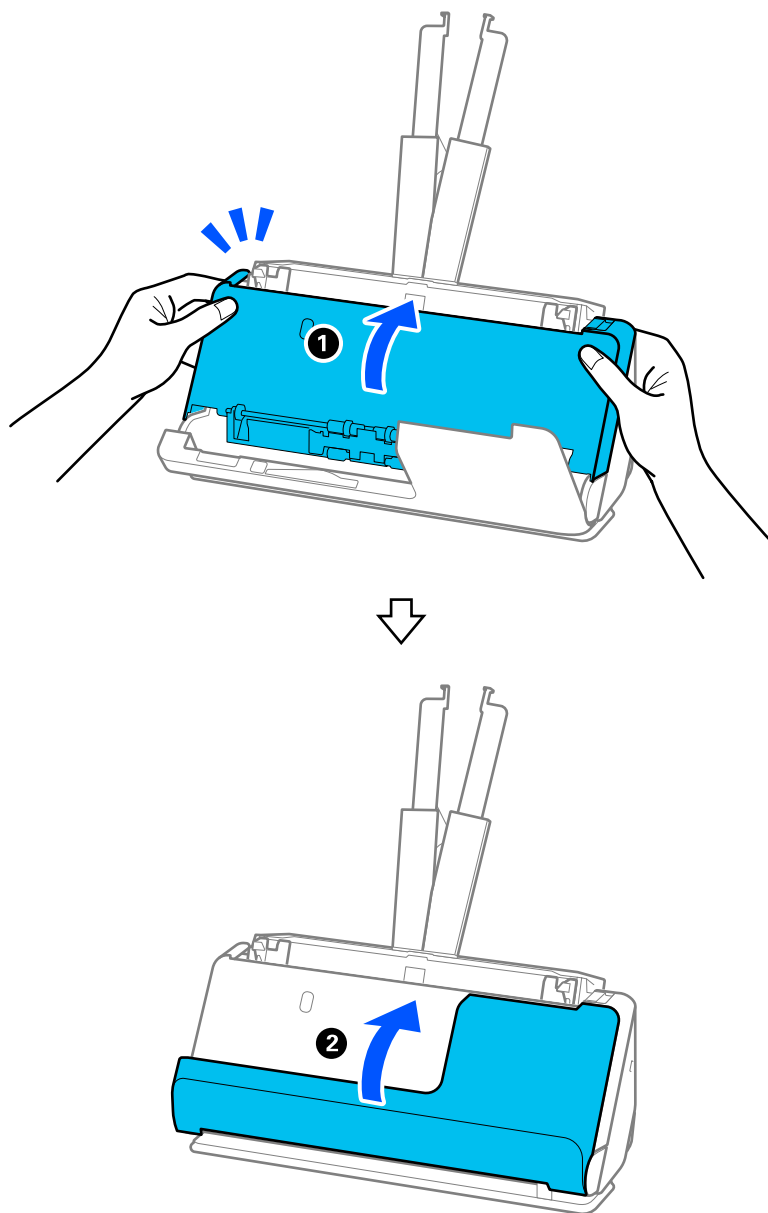

! *Important:*

Before restarting scanning, make sure that the scanner is stationary. If the scanner is not stationary, it could cause the original to jam.

For the Straight Path Position

1. Remove all originals remaining in the input tray.

2. Pull the lever to open the scanner cover.

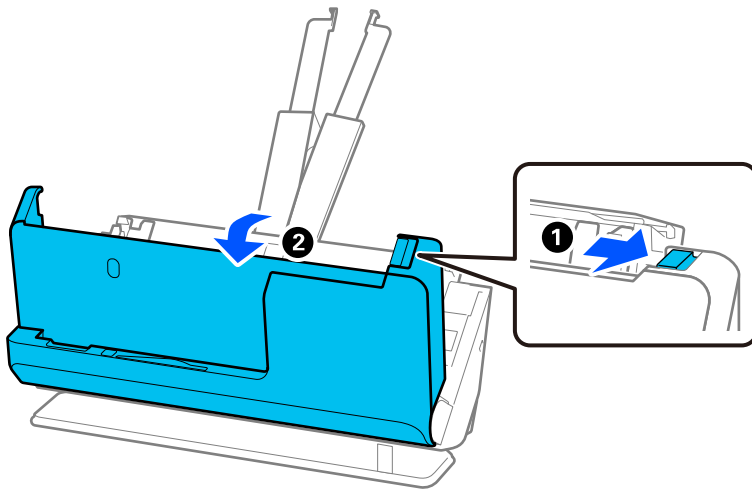

3. Carefully remove any jammed originals.

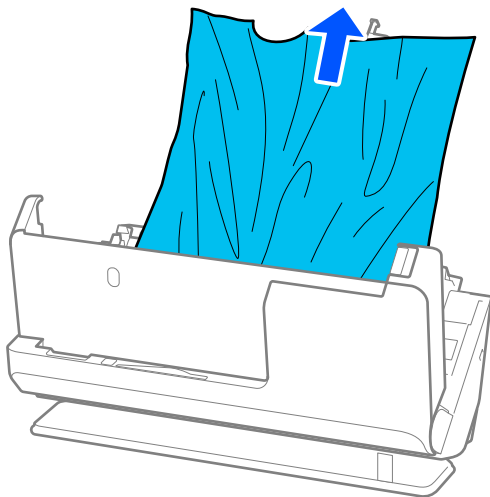

4. If you cannot pull originals straight up, carefully pull out any jammed originals from the output slot in the direction of the arrow.

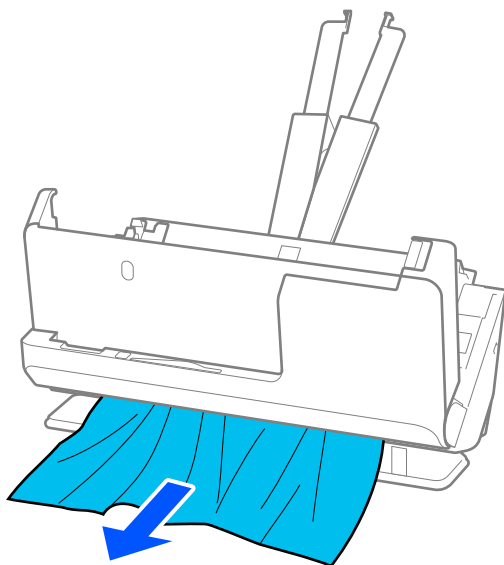

! *Important:*

Make sure there is no paper inside the scanner.

5. Close the scanner cover with both hands.

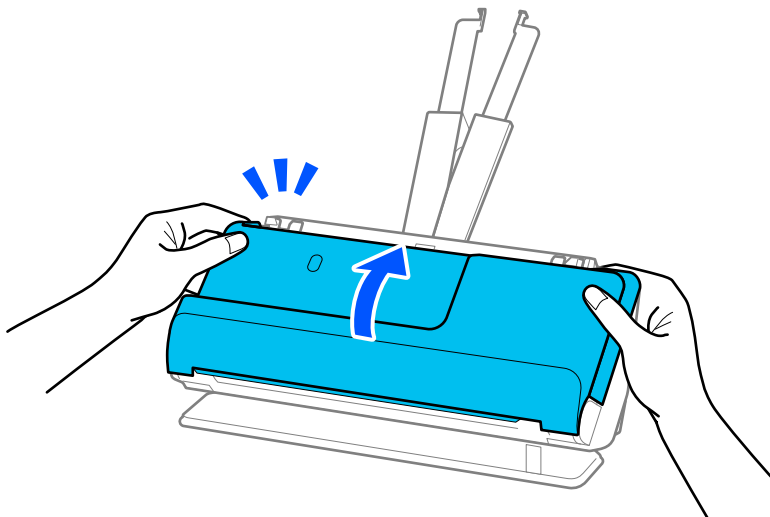

! *Important:*

Before restarting scanning, make sure that the scanner is stationary. If the scanner is not stationary, it could cause the original to jam.

Paper Jams, Paper Feed Errors, and Document Protection Issues Occur Frequently

If the following problems occur, check the original and the status of the scanner.

- Originals jam frequently
- Paper feed errors occur frequently
- Document protection issues occur frequently

Points to check when loading originals

- For originals with folds or that are curled, flatten the original before loading.
- When loading originals with a mixture of different sizes, load the originals with the side to be scanned facing up and in descending order of paper size with the widest at the back and the narrowest at the center of the input tray. Next, slide the edge guides to align them with the widest originals.

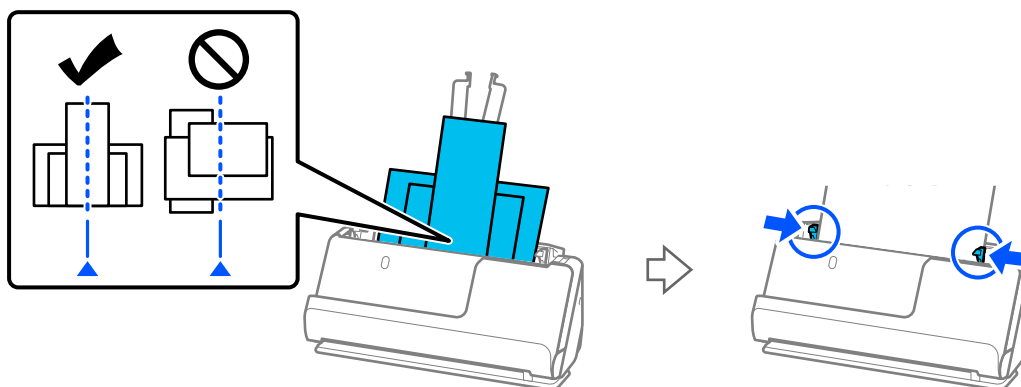

[“Loading Batches of Originals with Different Paper Types and Sizes” on page 82](#)

If the problem is not solved, try scanning the originals at each size separately, or scan the originals one by one. Align the edge guides to the width of the originals each time you load them.

Note:

You can use the following methods to scan the originals multiple times separately and then save them to one file.

- When you are using Epson Scan 2, select **Add or edit pages after scanning** checkbox, and then scan the original. You can add different originals or edit (rotate, move, and delete) the scanned pages after scanning. See the Epson Scan 2 help for details.
- You can use scanner software.
See the Document Capture Pro help for details on adding or editing the scanned pages after scanning in Document Capture Pro.

- Enable Slow Mode (▶) to slow down the paper feeding speed.
- After scanning, remove the original from the output tray or the output slot.

Points to check on the scanner

- Clean the rollers inside the scanner.
[“Cleaning Inside the Scanner” on page 114](#)

- ❑ Check the number of sheets scanned by the pickup roller. If the number of scans exceeds the pickup roller's service life (50,000 sheets), replace the roller assembly kit with a new one.

Even if the number of scans does not exceed the pickup roller's service life, we recommend replacing the roller assembly kit with a new one if the surface of the roller is worn out.

[“Replacing the Roller Assembly Kit” on page 124](#)

Note:

You can check the number of sheets scanned by the pickup roller in the Epson Scan 2 Utility. Start the Epson Scan 2 Utility, click on the **Counter** tab, and then check the **Number of Scans in Roller Assembly Kit**.

Related Information

- ➔ [“Types of Originals that Require Attention” on page 38](#)
- ➔ [“Loading Batches of Originals with Different Paper Types and Sizes” on page 82](#)
- ➔ [“Cleaning Inside the Scanner” on page 114](#)
- ➔ [“Multiple Originals Are Fed \(Double Feed\)” on page 141](#)
- ➔ [“Paper Protection Does not Work Correctly” on page 149](#)

Paper Protection Does not Work Correctly

Depending on the original and the level you set, this feature may not work correctly.

- ❑ If false positives occur frequently, try lowering the level.
- ❑ If your original is damaged, check that this feature is enabled. If it is already enabled, increase the level of protection for the feature.

Related Information

- ➔ [“Removing Jammed Originals from the Scanner” on page 142](#)

The Originals Get Dirty

Clean the inside of the scanner.

Related Information

- ➔ [“Cleaning Inside the Scanner” on page 114](#)

Scanning Speed Slows Down when Scanning Continuously

When scanning continuously using the ADF, scanning slows down to prevent the scanner mechanism from overheating and being damaged. However, you can continue scanning.

To regain normal scanning speed, leave the scanner idle for at least 30 minutes. Scanning speed does not recover even if the power is off.

Scanning Takes a Long Time

- The scanning speed may slow down depending on the scanning conditions, such as high resolution, image adjustment features, file format, and so on.
- Computers with USB 3.0 (SuperSpeed) or USB 2.0 (Hi-Speed) ports can scan faster than those with USB 1.1 ports. If you are using a USB 3.0 or USB 2.0 port with the scanner, make sure it meets the system requirements.
- When using security software, exclude the TWAIN.log file from monitoring, or set the TWAIN.log as a read-only file. For more information on your security software's functions, see the help and so on supplied with the software. The TWAIN.log file is saved in the following locations.
C:\Users*(user name)*\AppData\Local\Temp

Scanned Image Problems

Lines (Streaks) Appear when Scanning from ADF

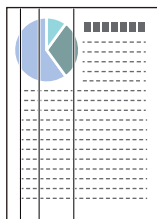

- Clean the ADF.
Straight lines (streaks) may appear in the image when debris or dirt gets into the ADF.
- Remove any debris or dirt that adheres to the original.
- Using **Glass Dirt Detection** feature, a notification is displayed when dirt is detected on the scanner glass inside the scanner.
Select **Scanner Setting** tab and then select **On-High** or **On-Low** from **Detect Glass Dirt** in Epson Scan 2 Utility .
When an alert is displayed, clean the glass surfaces inside your scanner using a genuine Epson cleaning kit or a soft cloth.
[“Cleaning Inside the Scanner” on page 114](#)

Note:

- Some stains may not be detected correctly.*
- If the detection does not work correctly, change the setting.*
*If no stains are detected, select **On-High**. If stains are detected incorrectly, select **On-Low** or **Off**.*

Related Information

- ➔ [“Cleaning Inside the Scanner” on page 114](#)
- ➔ [“Setting the Glass Surface Stain Detection Feature” on page 109](#)

Alert About Stains Inside the Scanner Still Appears

If the alert screen appears after cleaning the inside of the scanner, glass part will be required to replace. Contact your local dealer to repair.

Related Information

➔ [“Cleaning Inside the Scanner” on page 114](#)

Colors Are Uneven in the Scanned Image

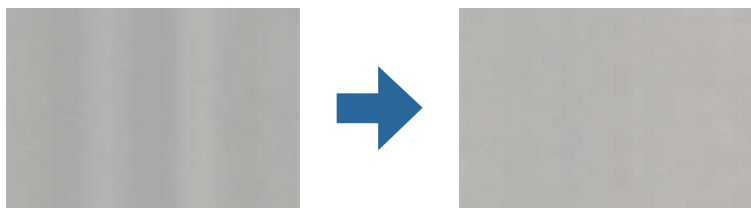

If the scanner is subject to strong light such as direct sunlight, the sensor inside the scanner misdetects the light and colors in the scanned image become uneven.

- Change the orientation of the scanner so that no strong light is falling on the front of the scanner.
- Move the scanner to a location where it will not be subjected to strong light.

Expanding or Contracting the Scanned Image

When expanding or contracting the scanned image, you can adjust the expansion ratio by using the **Adjustments** feature in Epson Scan 2 Utility. This feature is only available for Windows.

Note:

Epson Scan 2 Utility is one of the applications supplied with the scanner software.

1. Start Epson Scan 2 Utility.
 - Windows 11/Windows Server 2019/Windows Server 2022
Click the start button, and then select **All apps > EPSON > Epson Scan 2 Utility**.
 - Windows 10/Windows Server 2016
Click the start button, and then select **EPSON > Epson Scan 2 Utility**.
 - Windows 8.1/Windows 8/Windows Server 2012 R2/Windows Server 2012
Enter the application name in the search charm, and then select the displayed icon.
 - Windows 7/Windows Server 2008 R2
Click the start button, and then select **All Programs or Programs > EPSON > Epson Scan 2 > Epson Scan 2 Utility**.
2. Select the **Adjustments** tab.
3. Use **Expansion/Contraction** to adjust the expansion ratio for scanned images.
4. Click **Set** to apply the settings to the scanner.

An Image on the Back of Your Original Appears in Your Scanned Image

Images on the back of the original may appear in the scanned image.

- ❑ When **Auto**, **Color**, or **Grayscale** is selected as the **Image Type**:

- ❑ Check that **Remove Background** is selected.

Document Capture Pro (Windows)/Document Capture (Mac OS X): Press the **Detailed Settings** button on the **Scan Settings** screen to open the Epson Scan 2 screen. Click the **Advanced Settings** tab > **Remove Background**.

Epson Scan 2: On the **Advanced Settings** tab, select **Remove Background**.

- ❑ Check that **Text Enhancement** is selected.

Document Capture Pro (Windows)/Document Capture (Mac OS X): On the **Scan Settings** screen, select **Text Enhancement**.

Epson Scan 2: On the **Advanced Settings** tab, select **Text Enhancement**.

- ❑ When you select **Black & White** from **Image Type**:

Check that **Text Enhancement** is selected.

Document Capture Pro (Windows)/Document Capture (Mac OS X): On the **Scan Settings** screen, select **Text Enhancement**.

Epson Scan 2: On the **Advanced Settings** tab, select **Text Enhancement**.

Depending on the condition of your scanned image, click **Settings**, and then move the slider towards **Remove background**.

Scanned Text or Images are Missing or Blurred

You can adjust the appearance of the scanned image or text by increasing the resolution or adjusting the image quality.

- ❑ Change the resolution, and then scan again.

Set the appropriate resolution for the purpose of your scanned image.

- ❑ Check that **Text Enhancement** is selected.

Document Capture Pro (Windows)/Document Capture (Mac OS X): On the **Scan Settings** screen, select **Text Enhancement**.

Epson Scan 2: On the **Advanced Settings** tab, select **Text Enhancement**.

When you select **Black & White** as the **Image Type**, depending on the condition of the scanned image, click **Settings** and adjust the slider for **Emphasize light letters / Remove background**, turn off **Remove spot noise**, or set the level to **Low**.

- ❑ If you are scanning in JPEG format, try changing the compression level.

Document Capture Pro (Windows)/Document Capture (Mac OS X): Click **Option** on the **Save Settings** screen to change the JPEG quality.

Epson Scan 2: Click **Image Format** > **Options**, and then change the **Image Quality**.

Moiré Patterns (Web-Like Shadows) Appear

If the original is a printed document, moiré patterns (web-like shadows) may appear in the scanned image.

- Check that **Descreening** is selected in the Epson Scan 2 window. When you are using Document Capture Pro, you can open the window by pressing the **Detailed Settings** button on the **Scan Settings** screen.
Click the **Advanced Settings** tab > **Descreening**.



- Change the resolution, and then scan again.

The Edge of the Original is Not Scanned when Automatically Detecting the Size of the Original

Depending on the original, the edge of the original may not be scanned when automatically detecting the size of the original.

- Adjust **Crop Margins for Size "Auto"** in the Epson Scan 2 window. When you are using Document Capture Pro, you can open the window by pressing the **Detailed Settings** button on the **Scan Settings** screen.
Click the **Main Settings** tab > **Document Size** > **Settings**. On the **Document Size Settings** screen, adjust **Crop Margins for Size "Auto"**.
- Depending on the original, the area of the original may not be detected correctly when using the **Auto Detect** feature. Select the appropriate size of the original from the **Document Size** list.

Note:

*If the size of the original you want to scan is not on the list, create the size manually in the Epson Scan 2 window. When you are using Document Capture Pro, you can open the window by pressing the **Detailed Settings** button on the **Scan Settings** screen.*

*Click the **Main Settings** tab > **Document Size**, and then select **Customize**.*

Character is not Recognized Correctly

Check the following to increase the recognition rate of OCR (Optical Character Recognition).

- Check that the original is placed straight.
- Use an original with clear text. Text recognition may decline for the following types of originals.
 - Originals that have been copied many times
 - Originals received by fax (at low resolutions)
 - Originals with tightly spaced characters or line spacing
 - Originals with ruled lines or underlined text
 - Originals with hand-written text
 - Originals with creases or wrinkles
- Paper type made of thermal paper such as receipts may deteriorate due to age or friction. Scan them as soon as possible.
- When saving to Microsoft® Office or **Searchable PDF** files, check that the correct languages are selected.

- ❑ If you have set **Image Type** to **Color** or **Grayscale** in Epson Scan 2, try adjusting the **Text Enhancement** setting. Click the **Advanced Settings** tab > **Text Enhancement** > **Settings**, and then select **Emphasize light letters for OCR** as the **Mode**.

Note:

*You need the EPSON Scan OCR component to save as a **Searchable PDF**. This is installed automatically when you set up the scanner using the installer.*

Cannot Solve Problems in the Scanned Image

If you have tried all of the solutions and have not solved the problem, initialize the scanner driver (Epson Scan 2) settings using Epson Scan 2 Utility.

Note:

Epson Scan 2 Utility is one of the applications supplied with the scanner software.

1. Start Epson Scan 2 Utility.
 - ❑ Windows 11/Windows Server 2019/Windows Server 2022
Click the start button, and then select **All apps** > **EPSON** > **Epson Scan 2 Utility**.
 - ❑ Windows 10/Windows Server 2016
Click the start button, and then select **EPSON** > **Epson Scan 2 Utility**.
 - ❑ Windows 8.1/Windows 8/Windows Server 2012 R2/Windows Server 2012
Enter the application name in the search charm, and then select the displayed icon.
 - ❑ Windows 7/Windows Server 2008 R2/Windows Server 2008
Click the start button, and then select **All Programs** or **Programs** > **EPSON** > **Epson Scan 2** > **Epson Scan 2 Utility**.
 - ❑ Mac OS
Select **Go** > **Applications** > **Epson Software** > **Epson Scan 2 Utility**.
2. Select the **Other** tab.
3. Click **Reset**.

Note:

If initialization does not solve the problem, uninstall and re-install the scanner driver (Epson Scan 2).

Document Capture Pro Problems

For problems that occur when scanning using Document Capture Pro, access the following URL to check the Document Capture Pro manual.

<https://support.epson.net/dcp/>

Uninstalling and Installing Applications

Uninstalling Your Applications

You may need to uninstall and then reinstall your applications to solve certain problems or if you upgrade your operating system. Log on to your computer as an administrator. Enter the administrator password if the computer prompts you.

Uninstalling Your Applications for Windows

1. Quit all running applications.
2. Disconnect the scanner from your computer.
3. Open the Control Panel:
 - Windows 11/Windows Server 2022
Click the start button, and then select **All apps > Windows Tools > Control Panel**.
 - Windows 10/Windows Server 2016/Windows Server 2019
Click the start button, and then select **Windows System > Control Panel**.
 - Windows 8.1/Windows 8/Windows Server 2012 R2/Windows Server 2012
Select **Desktop > Settings > Control Panel**.
 - Windows 7/Windows Server 2008 R2
Click the start button, and then select **Control Panel**.
4. Select **Uninstall a program** in **Programs**.
5. Select the application you want to uninstall.
6. Click **Uninstall/Change** or **Uninstall**.

Note:
If the User Account Control window is displayed, click Continue.
7. Follow the on-screen instructions.

Note:
*A message may be displayed prompting you to restart your computer. If it is displayed, make sure **I want to restart my computer now** is selected, and then click **Finish**.*

Uninstalling Your Applications for Mac OS

Note:
Make sure you installed EPSON Software Updater.

1. Download the Uninstaller using EPSON Software Updater.
Once you have downloaded the Uninstaller, you do not need to download it again each time you uninstall the application.

2. Disconnect the scanner from your computer.
3. To uninstall the scanner driver, select **System Preferences** from the Apple menu > **Printers & Scanners** (or **Print & Scan, Print & Fax**), and then remove the scanner from the enabled scanner list.
4. Quit all running applications.
5. Select **Go > Applications > Epson Software > Uninstaller**.
6. Select the application you want to uninstall, and then click Uninstall.



Important:

The Uninstaller removes all drivers for Epson scanners on the computer. If you use multiple Epson scanners and you only want to delete some of the drivers, delete all of them first, and then install the necessary scanner drivers again.

Note:

*If you cannot find the application you want to uninstall in the application list, you cannot uninstall using the Uninstaller. In this situation, select **Go > Applications > Epson Software**, select the application you want to uninstall, and then drag it to the trash icon.*

Installing Your Applications

Follow the steps below to install the necessary applications.

Note:

- Log on to your computer as an administrator. Enter the administrator password if the computer prompts you.
- When reinstalling applications, you need to uninstall them first.

1. Quit all running applications.
2. When installing scanner driver (Epson Scan 2), disconnect the scanner and the computer temporarily.

Note:

Do not connect the scanner and the computer until you are instructed to do so.

3. Install the application by following the instructions on the Website below.

<https://epson.sn>

Technical Specifications

General Scanner Specifications.	158
Dimensions and Weight Specifications.	159
Electrical Specifications.	160
Environmental Specifications.	160
System Requirements.	161

General Scanner Specifications

Note:

Specifications are subject to change without notice.

Scanner type	Sheet Feed, one pass duplex color scanner
Photoelectric device	CIS
Effective pixels	5,100×9,300 at 600 dpi 2,550×64,500 at 300 dpi
Light source	RGB LED
Scanning resolution	600 dpi (main scan) 600 dpi (sub scan)
Output resolution	50 to 1200 dpi (in 1 dpi increments) *1
Document Size	Max: 215.9×5,588 (8.5×220 inches) Min: 50.8×50.8 mm (2×2 inches)
Paper input	Face-up loading
Paper output	Vertical path position: Face-down ejection Straight path position: Face-up ejection
Paper capacity	20 sheets of paper at 80 g/m ²
Color Depth	<p>Color</p> <ul style="list-style-type: none"> <input type="checkbox"/> 30 bits per pixel internal (10 bits per pixel per color internal) <input type="checkbox"/> 24 bits per pixel external (8 bits per pixel per color external) <p>Grayscale</p> <ul style="list-style-type: none"> <input type="checkbox"/> 10 bits per pixel internal <input type="checkbox"/> 8 bits per pixel external <p>Black and white</p> <ul style="list-style-type: none"> <input type="checkbox"/> 10 bits per pixel internal <input type="checkbox"/> 1 bit per pixel external
Interface	Hi-Speed USB

*1 This value is when scanning with a computer. Available resolutions may vary depending on the scanning method.

Dimensions and Weight Specifications

Dimensions

Vertical path position (units: mm (inches))

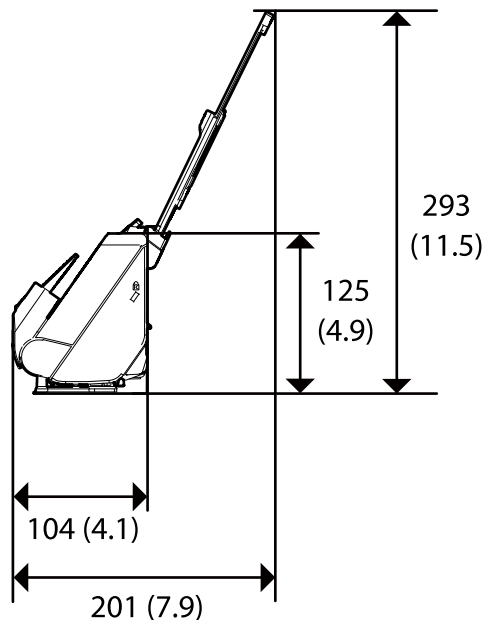
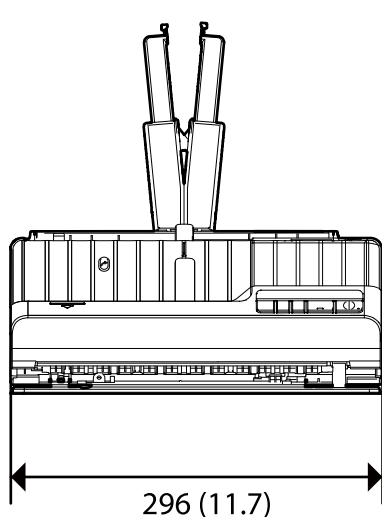

Straight path position (units: mm (inches))

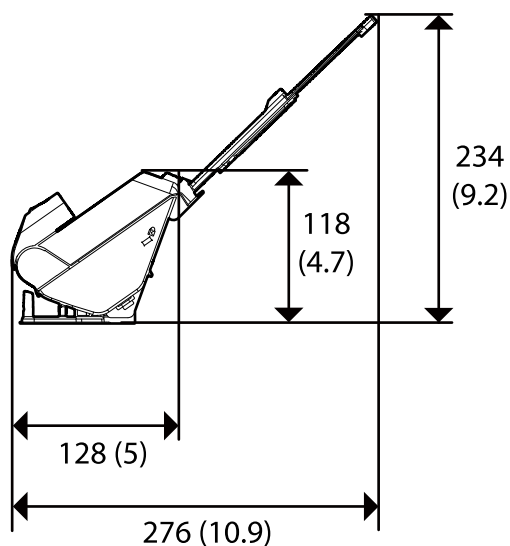
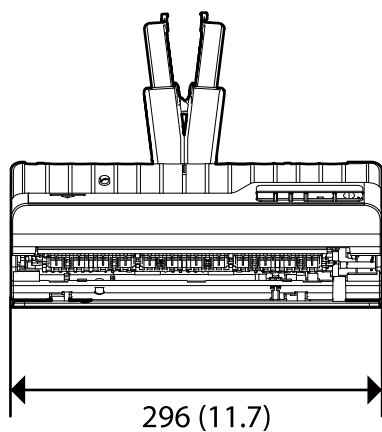

Weight

Approx. 1.9 kg (4.2 lb)

Electrical Specifications

Scanner Electrical Specifications

Rated DC Input Power Supply Voltage	DC 24 V
Rated DC Input Current	1 A
Power Consumption	<input type="checkbox"/> Operating: Approx. 13 W <input type="checkbox"/> Ready mode: Approx. 3.6 W <input type="checkbox"/> Sleep mode : Approx. 1.0 W <input type="checkbox"/> Power off: Approx. 0.1 W

Note:

For European users, see the following Website for details on power consumption.

<http://www.epson.eu/energy-consumption>

AC Adapter Electrical Specifications

Model	A461H (AC 100-240 V) A462E (AC 220-240 V)
Rated Input Current	1 A
Rated Frequency Range	50-60 Hz
Rated Output Power Supply Voltage	DC 24 V
Rated Output Current	1 A

Note:

For European users, see the following Website for details on power consumption.

<http://www.epson.eu/energy-consumption>

Environmental Specifications

Temperature	When operating	5 to 35 °C (41 to 95 °F)
	When stored	-25 to 60 °C (-13 to 140 °F)
Humidity	When operating	15 to 80% (without condensation)
	When stored	15 to 85% (without condensation)
Operating conditions		Ordinary office or home conditions. Avoid operating the scanner in direct sunlight, near a strong light source, or in extremely dusty conditions.

System Requirements

Supported operating systems may vary depending on the application.

Windows ^{*1}	Windows 11 or later Windows 10 Windows 8/8.1 Windows 7 Windows Server 2008 or later
Mac OS ^{*2 *3}	Mac OS X 10.9 or later, macOS 11 or later

*1 Document Capture Pro does not support Windows Vista/Windows XP, and Windows Server.

*3 The UNIX File System (UFS) for Mac OS is not supported.

*2 Fast User Switching on Mac OS or later is not supported.

Standards and Approvals

Standards and Approvals for European Models.	163
Standards and Approvals for U.S. Models.	163
OPEN SOURCE SOFTWARE LICENSE.	163

Standards and Approvals for European Models

Product and AC adapter

The following models are CE marked and in compliance with all the applicable EU Directives. For further details, visit the following website to access the full declaration of conformities containing reference to the Directives and harmonized standards used to declare conformity.

<http://www.epson.eu/conformity>

J441E

A461H, A462E

Standards and Approvals for U.S. Models

Product

EMC	FCC Part 15 Subpart B Class B CAN ICES-3 (B)/NMB-3 (B)
-----	---

AC adapter (A461H)

EMC	FCC Part 15 Subpart B Class B CAN ICES-3 (B)/NMB-3 (B)
-----	---

OPEN SOURCE SOFTWARE LICENSE

- 1) This product includes open source software programs according to the license terms of each open source software program.
- 2) The open source software programs are WITHOUT ANY WARRANTY; without even the implied warranty of MERCHANTABILITY AND FITNESS FOR A PARTICULAR PURPOSE.

See the license agreements of each open source software program for more details, which are described below.

SHA1 license

Copyright (C) The Internet Society (2001). All Rights Reserved.

This document and translations of it may be copied and furnished to others, and derivative works that comment on or otherwise explain it or assist in its implementation may be prepared, copied, published and distributed, in whole or in part, without restriction of any kind, provided that the above copyright notice and this paragraph are included on all such copies and derivative works.

However, this document itself may not be modified in any way, such as by removing the copyright notice or references to the Internet Society or other Internet organizations, except as needed for the purpose of developing Internet standards in which case the procedures for copyrights defined in the Internet Standards process must be followed, or as required to translate it into languages other than English.

The limited permissions granted above are perpetual and will not be revoked by the Internet Society or its successors or assigns.

This document and the information contained herein is provided on an "AS IS" basis and THE INTERNET SOCIETY AND THE INTERNET ENGINEERING TASK FORCE DISCLAIMS ALL WARRANTIES, EXPRESS OR IMPLIED, INCLUDING BUT NOT LIMITED TO ANY WARRANTY THAT THE USE OF THE INFORMATION HEREIN WILL NOT INFRINGE ANY RIGHTS OR ANY IMPLIED WARRANTIES OF MERCHANTABILITY OR FITNESS FOR A PARTICULAR PURPOSE.

Info-ZIP license

This is version 2007-Mar-4 of the Info-ZIP license.

The definitive version of this document should be available at <ftp://ftp.info-zip.org/pub/infozip/license.html> indefinitely and a copy at <http://www.info-zip.org/pub/infozip/license.html>.

Copyright © 1990-2007 Info-ZIP. All rights reserved.

For the purposes of this copyright and license, "Info-ZIP" is defined as the following set of individuals:

Mark Adler, John Bush, Karl Davis, Harald Denker, Jean-Michel Dubois, Jean-loup Gailly, Hunter Goatley, Ed Gordon, Ian Gorman, Chris Herborth, Dirk Haase, Greg Hartwig, Robert Heath, Jonathan Hudson, Paul Kienitz, David Kirschbaum, Johnny Lee, Onno van der Linden, Igor Mandrichenko, Steve P. Miller, Sergio Monesi, Keith Owens, George Petrov, Greg Roelofs, Kai Uwe Rommel, Steve Salisbury, Dave Smith, Steven M. Schweda, Christian Spieler, Cosmin Truta, Antoine Verheijen, Paul von Behren, Rich Wales, Mike White.

This software is provided "as is," without warranty of any kind, express or implied.

In no event shall Info-ZIP or its contributors be held liable for any direct, indirect, incidental, special or consequential damages arising out of the use of or inability to use this software.

Permission is granted to anyone to use this software for any purpose, including commercial applications, and to alter it and redistribute it freely, subject to the above disclaimer and the following restrictions:

1. Redistributions of source code (in whole or in part) must retain the above copyright notice, definition, disclaimer, and this list of conditions.
2. Redistributions in binary form (compiled executables and libraries) must reproduce the above copyright notice, definition, disclaimer, and this list of conditions in documentation and/or other materials provided with the distribution.

The sole exception to this condition is redistribution of a standard UnZipSFX binary (including SFXWiz) as part of a self-extracting archive; that is permitted without inclusion of this license, as long as the normal SFX banner has not been removed from the binary or disabled.

3. Altered versions--including, but not limited to, ports to new operating systems, existing ports with new graphical interfaces, versions with modified or added functionality, and dynamic, shared, or static library versions not from Info-ZIP--must be plainly marked as such and must not be misrepresented as being the original source or, if binaries, compiled from the original source.

Such altered versions also must not be misrepresented as being Info-ZIP releases--including, but not limited to, labeling of the altered versions with the names "Info-ZIP" (or any variation thereof, including, but not limited to, different capitalizations), "Pocket UnZip," "WiZ" or "MacZip" without the explicit permission of Info-ZIP.

Such altered versions are further prohibited from misrepresentative use of the Zip-Bugs or Info-ZIP e-mail addresses or the Info-ZIP URL(s), such as to imply Info-ZIP will provide support for the altered versions.

4. Info-ZIP retains the right to use the names "Info-ZIP," "Zip," "UnZip," "UnZipSFX," "WiZ," "Pocket UnZip," "Pocket Zip," and "MacZip" for its own source and binary releases.

lua license

Copyright (C) 1994-2013 Lua.org, PUC-Rio.

Permission is hereby granted, free of charge, to any person obtaining a copy of this software and associated documentation files (the "Software"), to deal in the Software without restriction, including without limitation the rights to use, copy, modify, merge, publish, distribute, sublicense, and/or sell copies of the Software, and to permit persons to whom the Software is furnished to do so, subject to the following conditions:

The above copyright notice and this permission notice shall be included in all copies or substantial portions of the Software.

THE SOFTWARE IS PROVIDED "AS IS", WITHOUT WARRANTY OF ANY KIND, EXPRESS OR IMPLIED, INCLUDING BUT NOT LIMITED TO THE WARRANTIES OF MERCHANTABILITY, FITNESS FOR A PARTICULAR PURPOSE AND NONINFRINGEMENT.

IN NO EVENT SHALL THE AUTHORS OR COPYRIGHT HOLDERS BE LIABLE FOR ANY CLAIM, DAMAGES OR OTHER LIABILITY, WHETHER IN AN ACTION OF CONTRACT, TORT OR OTHERWISE, ARISING FROM, OUT OF OR IN CONNECTION WITH THE SOFTWARE OR THE USE OR OTHER DEALINGS IN THE SOFTWARE.

Where to Get Help

Technical Support Web Site.	167
Contacting Epson Support.	167

Technical Support Web Site

If you need further help, visit the Epson support website shown below. Select your country or region and go to the support section of your local Epson website. The latest drivers, FAQs, manuals, or other downloadables are also available from the site.

<http://support.epson.net/>

<http://www.epson.eu/support> (Europe)

If your Epson product is not operating properly and you cannot solve the problem, contact Epson support services for assistance.

Contacting Epson Support

Before Contacting Epson

If your Epson product is not operating properly and you cannot solve the problem using the troubleshooting information in your product manuals, contact Epson support services for assistance. If Epson support for your area is not listed below, contact the dealer where you purchased your product.

Epson support will be able to help you much more quickly if you give them the following information:

- Product serial number
(The serial number label is usually on the back of the product.)
- Product model
- Product software version
(Click **About**, **Version Info**, or a similar button in the product software.)
- Brand and model of your computer
- Your computer operating system name and version
- Names and versions of the software applications you normally use with your product

Note:

Depending on the product, the dial list data for fax and/or network settings may be stored in the product's memory. Due to breakdown or repair of a product, data and/or settings may be lost. Epson shall not be responsible for the loss of any data, for backing up or recovering data and/or settings even during a warranty period. We recommend that you make your own backup data or take notes.

Help for Users in Europe

Check your Pan-European Warranty Document for information on how to contact Epson support.

Help for Users in Taiwan

Contacts for information, support, and services are:

World Wide Web

<http://www.epson.com.tw>

Information on product specifications, drivers for download, and products enquiry are available.

Epson HelpDesk

Phone: +886-2-2165-3138

Our HelpDesk team can help you with the following over the phone:

- Sales enquiries and product information
- Product usage questions or problems
- Enquiries on repair service and warranty

Repair service center:

<http://www.tekcare.com.tw/branchMap.page>

TekCare corporation is an authorized service center for Epson Taiwan Technology & Trading Ltd.

Help for Users in Singapore

Sources of information, support, and services available from Epson Singapore are:

World Wide Web

<http://www.epson.com.sg>

Information on product specifications, drivers for download, Frequently Asked Questions (FAQ), Sales Enquiries, and Technical Support via e-mail are available.

Epson HelpDesk

Toll Free: 800-120-5564

Our HelpDesk team can help you with the following over the phone:

- Sales enquiries and product information
- Product usage questions or problem troubleshooting
- Enquiries on repair service and warranty

Help for Users in Thailand

Contacts for information, support, and services are:

World Wide Web

<http://www.epson.co.th>

Information on product specifications, drivers for download, Frequently Asked Questions (FAQ), and e-mail are available.

Epson Call Centre

Phone: 66-2460-9699

Email: support@eth.epson.co.th

Our Call Centre team can help you with the following over the phone:

- Sales enquiries and product information
- Product usage questions or problems
- Enquiries on repair service and warranty

Help for Users in Vietnam

Contacts for information, support, and services are:

Epson Service Center

27 Yen Lang, Trung Liet Ward, Dong Da District, Ha Noi City. Tel: +84 24 7300 0911

38 Le Dinh Ly, Thac Gian Ward, Thanh Khe District, Da Nang. Tel: +84 23 6356 2666

194/3 Nguyen Trong Tuyen, Ward 8, Phu Nhuan Dist., HCMC. Tel: +84 28 7300 0911

31 Phan Boi Chau, Ward 14, Binh Thanh District, HCMC. Tel: +84 28 35100818

Help for Users in Indonesia

Contacts for information, support, and services are:

World Wide Web

<http://www.epson.co.id>

- Information on product specifications, drivers for download
- Frequently Asked Questions (FAQ), Sales Enquiries, questions through e-mail

Epson Hotline

Phone: 1500-766 (Indonesia Only)

Email: customer.care@ein.epson.co.id

Our Hotline team can help you with the following over the phone or email:

- Sales enquiries and product information
- Technical support

Help for Users in Hong Kong

To obtain technical support as well as other after-sales services, users are welcome to contact Epson Hong Kong Limited.

Internet Home Page

<http://www.epson.com.hk>

Epson Hong Kong has established a local home page in both Chinese and English on the Internet to provide users with the following information:

- Product information
- Answers to Frequently Asked Questions (FAQs)
- Latest versions of Epson product drivers

Technical Support Hotline

You can also contact our technical staff at the following telephone and fax numbers:

Phone: 852-2827-8911

Fax: 852-2827-4383

Help for Users in Malaysia

Contacts for information, support, and services are:

World Wide Web

<http://www.epson.com.my>

- Information on product specifications, drivers for download
- Frequently Asked Questions (FAQ), Sales Enquiries, questions through e-mail

Epson Call Centre

Phone: 1800-81-7349 (Toll Free)

Email: websupport@emsb.epson.com.my

- Sales enquiries and product information
- Product usage questions or problems
- Enquiries on repair services and warranty

Epson Malaysia Sdn Bhd (Head Office)

Phone: 603-56288288

Fax: 603-5628 8388/603-5621 2088

Help for Users in India

Contacts for information, support, and services are:

World Wide Web

<http://www.epson.co.in>

Information on product specifications, drivers for download, and products enquiry are available.

Toll Free Helpline

For Service, Product information or to order consumables -

18004250011 / 186030001600 / 1800123001600 (9AM – 6PM)

Email

calllog@epson-india.in

WhatsApp

+91 96400 00333

Help for Users in the Philippines

To obtain technical support as well as other after sales services, users are welcome to contact the Epson Philippines Corporation at the telephone, fax numbers and e-mail address below:

World Wide Web

<http://www.epson.com.ph>

Information on product specifications, drivers for download, Frequently Asked Questions (FAQ), and E-mail Enquiries are available.

Epson Philippines Customer Care

Toll Free: (PLDT) 1-800-1069-37766

Toll Free: (Digitel) 1-800-3-0037766

Metro Manila: +632-8441-9030

Web Site: <https://www.epson.com.ph/contact>

E-mail: customercare@epc.epson.com.ph

Accessible 9am to 6pm, Monday through Saturday (Except public holidays)

Our Customer Care team can help you with the following over the phone:

- Sales enquiries and product information
- Product usage questions or problems
- Enquiries on repair service and warranty

Epson Philippines Corporation

Trunk Line: +632-8706-2609

Fax: +632-8706-2663 / +632-8706-2665