

		SUB SOURCE POSSIBILITY (x1)		
MultiView	Inputs	HDMI	DisplayPort	USBC
MAIN SOURCE (x1)	HDMI	●	●	●
	DisplayPort	●	●	●
	USBC	●	●	●



Register your product and get support at www.philips.com/support



Version: M1140BU5600Q1WWT
2022 © TOP Victory Investments Ltd. All rights reserved.

This product has been manufactured by and is sold under the responsibility of Top Victory Investments Ltd., and Top Victory Investments Ltd. is the warrantor in relation to this product. Philips and the Philips Shield Emblem are registered trademarks of Koninklijke Philips N.V. and are used under license.

Specifications are subject to change without notice.

HDMI

The terms HDMI, HDMI High-Definition Multimedia Interface, HDMI Trade Dress and the HDMI Logos are trademarks or registered trademarks of HDMI Licensing Administrator, Inc.

www.philips.com

Energy Labelling
40B1U5600



Printed in China



Q41G40M181309A

PHILIPS

Business Monitor

5000 Series



40B1U5600

Quick start

Register your product and get support at www.philips.com/welcome

Contents

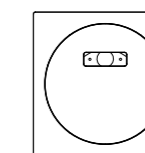
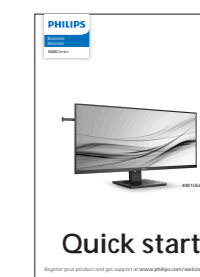
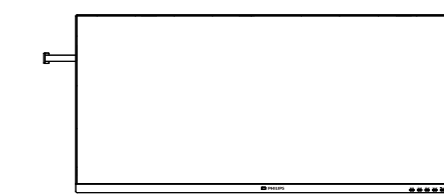

Screw and screwdriver
M4 x 4

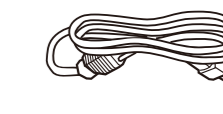

Power

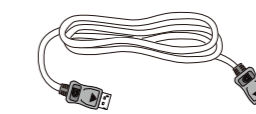

* DP

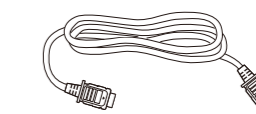

* HDMI

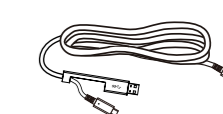

*USB C-C/A

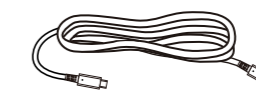

*USB C-C

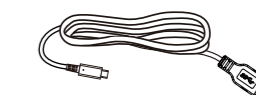

*USB C-A

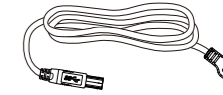

*USB A-B

*Different according to region
Display design may differ from that illustrated

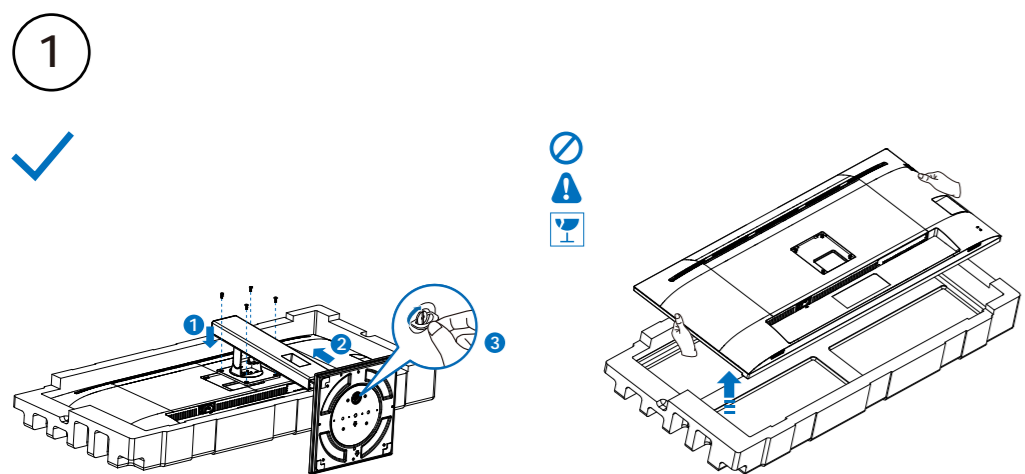

CAUTION: Place the monitor face down on a smooth surface. Pay attention not to scratch or damage the screen.

