

All-in-One Android Video Collaboration Bar for Small and Huddle Rooms

Yealink MeetingBar A20, an all-in-one video collaboration bar for small and huddle rooms. Featuring 20MP camera and 120° wide-angle lens, A20 delivers outstanding video quality. Together with the electric lens cap, its AI technologies, including Auto Framing and Speaker Tracking and so on, allow users to experience a smarter and safer video conference. With 8 MEMS microphone arrays and Yealink AI based noise proof technology, A20 brings excellent audio experience in small rooms even in full-duplex mode and ensures that everyone can be heard as well as seen. Moreover, A20 combines computing unit, camera, microphones, speaker, Wi-Fi, and Bluetooth, which provides you a solution of simple deployment. A20 supports for cloud video platforms like Microsoft Teams and Zoom, so no room PC is required. A20 is capable of content sharing and whiteboard that makes the meeting more communicative and collaborative. Simple and flexible deployment but powerful features deliver excellent video collaboration performance.

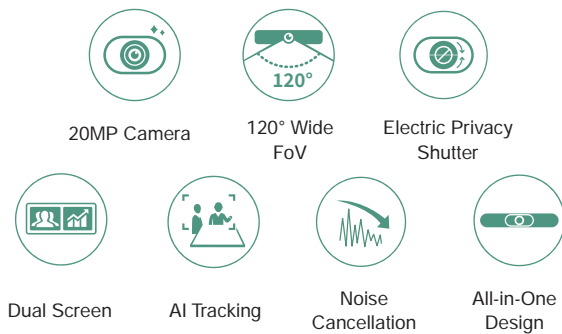

Key Features and Benefits

Smart Video Collaboration

Based on Android 10.0 OS, A20 owns native Teams or Zoom experience that all features can be operated by just one touch or by the remote control. Also, you can experience a more communicative and collaborative meeting with the content sharing and whiteboard of A20.

See Everyone Clearly

A20 has strong image processing, encoding and decoding capabilities. Besides, with a 20MP camera, it can provide a high-quality video conference experience. With wide 120° field of view, everyone in the conference can be seen without adjusting the camera. Moreover, the image brightness can be automatically optimized even in a dim or backlight environment, ensuring the participant faces can be seen clearly.

Smart Video Conferencing with AI Technology

The A20 camera supports 4K video output, providing you with a face-to-face, intelligent and smooth video experience by accurately reproducing every moment and detail. Featuring multiple AI technologies such as Auto Framing, Speaker Tracking, Picture-in-Picture, and Multi-Focus Framing, users don't need to adjust the camera manually and can focus more on the conference.

Precise Sound Localization, Full-Duplex Experience

8 MEMS microphone arrays make A20 have strong ability of Yealink AI based noise proof technology and dereverberation. The Yealink beamforming algorithm, together with technology of acoustic echo cancellation and the dereverberation, brings high quality full-duplex call and realizes more precise voice pickup.









All-in-One Design for Fast Start

Integrating computing unit, camera, microphones, speaker, Bluetooth, Wi-Fi and bracket, A20 takes up less space and minimizing cable clutter. Plugging in power and HDMI cable gets a video conference ready. In addition, the Yealink Device Management Platform ensures an easy management to you.

Wireless Presentation with Low Latency

Cooperating A20 with Yealink wireless presentation pod WPP30, users can start a meeting anywhere in the conference room. WPP30 supports wireless presentation and wireless Device Mode, effectively integrating participants' opinions and improving meeting efficiency. With the Yealink algorithm, WPP30 can maintain a stable wireless connection even in complex network environments and delivers a super clear, speedy and stable presenting experience with low latency.

- All-in-One Design
- 20MP Camera
- 120° Field of View
- Electric Privacy Shutter
- Dual Screen
- Auto Framing and Speaker Tracking
- Built-in Bluetooth
- Built-in Dual-band Wi-Fi
- Content Sharing
- Whiteboard
- Certified by Microsoft Teams & Zoom

<p>Camera</p> <ul style="list-style-type: none"> • 20MP Camera • 120° field of view • 8x e-PTZ camera • Electric privacy shutter • 120° DFOV, 110° HFOV, 73° VFOV • Intelligence Features <ul style="list-style-type: none"> - Auto Framing - Speaker Tracking - Picture in Picture - Multi-focus Framing - Smart Gallery (Zoom only) <p>Audio</p> <ul style="list-style-type: none"> • Built-in 8 MEMS microphone array • Built-in 5 W high fidelity speaker • Yealink Noise Proof Technology • Full-duplex • Echo cancellation <p>Operating System</p> <ul style="list-style-type: none"> • Android 10.0 <p>Meeting Features</p> <ul style="list-style-type: none"> • Calendar • One-click join • Meeting collaboration <ul style="list-style-type: none"> - Content sharing - Whiteboard • Meeting control: <ul style="list-style-type: none"> - Add participates - Hold/Resume - Camera On/Off - Mute/Unmute - Volume Up/Down - Hang up • Teams Edition <ul style="list-style-type: none"> - Microsoft DM - Proximity join 	<ul style="list-style-type: none"> • Zoom Edition <ul style="list-style-type: none"> - Zoom DM - Direct sharing <p>Video Standard and Network Suitability</p> <ul style="list-style-type: none"> • Video codecs: H.264 High profile, H.264 SVC, H.264 <p>Network and Security Features</p> <ul style="list-style-type: none"> • Built-in dual-band Wi-Fi (2.4 GHz/5 GHz) • Built-in Bluetooth • IPv4 and IPv6, DHCP/static IP • HTTP/HTTPS web server • SRTP/TLS, AES 256-bit encryption • QoS: 802.1p/q, Diff-serv • VLAN, LLDP • IEEE802.1X <ul style="list-style-type: none"> - EAP-MD5/EAP-TLS - PEAP-MSCHAPv2 - EAP-TTLS/EAP-MSCHAPv2 • Network diagnosis: Ping, Trace route • Time and date synchronization using SNTP • Built-in certificate • Simple Certificate Enrollment Protocol (SCEP) <ul style="list-style-type: none"> * coming soon <p>Connections</p> <ul style="list-style-type: none"> • 2 x HDMI output (CEC supported) • HDMI input (through the VCH51 Sharing Kit) • Motion sensor (Teams supported) • 1 x USB 2.0 • 1 x 10 M/100 M/1000 M Ethernet port • 1 x Yealink VCH port (RJ-45) • 1 x Power port • 1 x Security lock slot • 1 x Reset slot <p>Other Physical Features</p> <ul style="list-style-type: none"> • Storage: built-in 64 GB 	<ul style="list-style-type: none"> • Power Adapter: AC 100-240 V Input and DC 48 V/0.7 A Output • USB Output: 5 V \equiv 0.5 A • Power consumption (PSU): <ul style="list-style-type: none"> Idle < 10 W; Normal operating: 10.5 W; MAX: 14 W • Dimension (W.D.H): 600 mm x 68 mm x 82 mm • N.W/CTN: 2.892 kg (A20-010) • G.W/CTN: 3.484 kg (A20-010) • Operating humidity: 10-95% • Operating temperature: 0-40°C • Storage temperature: -30 to +70°C <p>MeetingBar A20 Package</p> <ul style="list-style-type: none"> • Package contents: <ul style="list-style-type: none"> - MeetingBar A20 endpoint - 3 m Ethernet cable - 2 x 1.8 m HDMI cable - Mounting Bracket and Accessories - TV-Clip Mount - Power adapter - Quick Start Guide - Controller (optional): <ul style="list-style-type: none"> CTP18 Touch Panel VCR20 Remote Control VCR11 Remote Control - Content sharing(optional): <ul style="list-style-type: none"> VCH51 Sharing Kit (HDMI/USB-C) WPP20 Wireless Presentation Pod WPP30 Wireless Presentation Pod • Carton Meas: 674 mm * 136 mm * 195 mm <p>MeetingBar A20 + CTP18 Package</p> <ul style="list-style-type: none"> • Carton Meas: 685 mm * 290 mm * 397 mm <p>Compliance</p> <p>      </p> <p>    </p>
--	--	--

Endpoint Connections

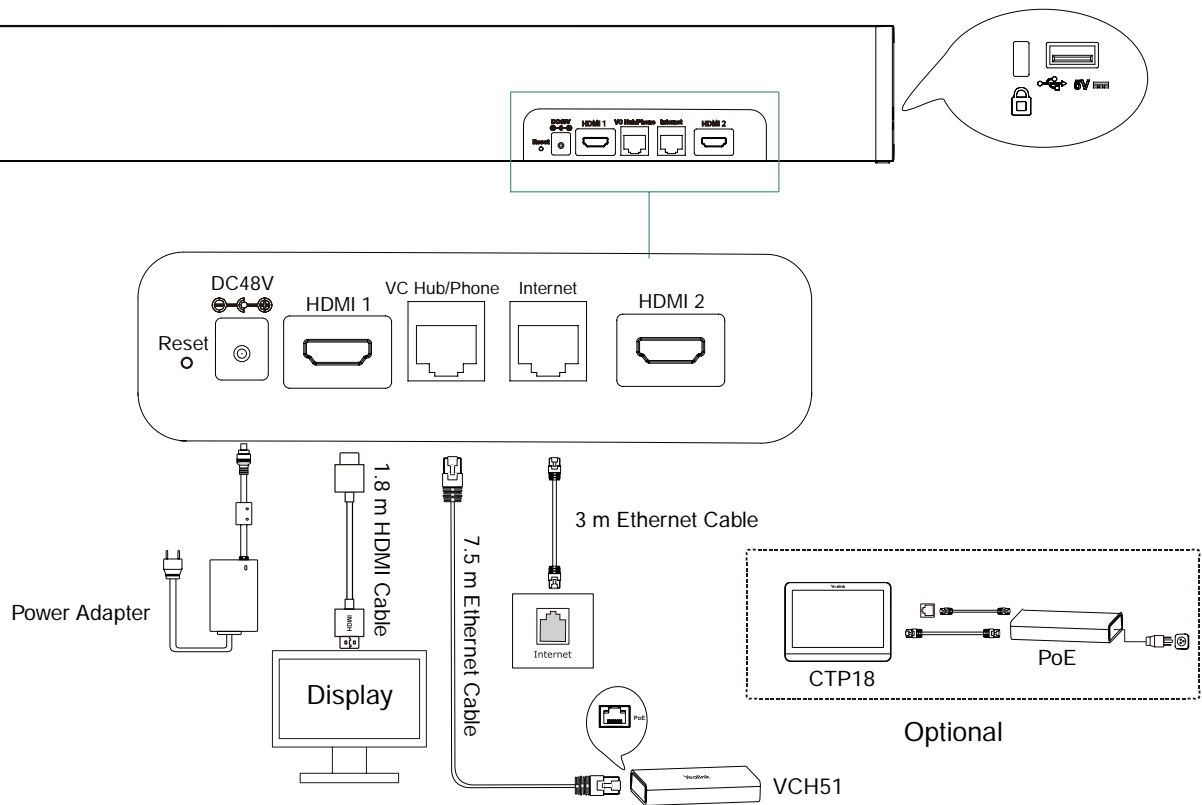

Note:

- If you connect a touch display device, you can operate the A20 either by remote control or touch control.
- If you connect a non-touch display device, you can use the remote control, mouse, or CTP18.

About Yealink

Yealink (Stock Code: 300628) is a global-leading provider of Unified Communication & Collaboration Solutions specialized in video conferencing, voice communications, and collaboration, dedicated to helping every person and organization embrace the power of "Easy Collaboration, High Productivity".

With best-in-class quality, innovative technology, and user-friendly experiences, Yealink is one of the best providers in more than 140 countries and regions, ranks No.1 in the global market share of IP Phone, and is the Top 5 leader in the video conferencing market (Frost & Sullivan, 2021).

For more information about Yealink, [click here](#).

Copyright

Copyright © 2022 YEALINK(XIAMEN) NETWORK TECHNOLOGY CO., LTD.

All rights reserved. No parts of this publication may be reproduced or transmitted in any form or by any means, electronic or mechanical, photocopying, recording, or otherwise, for any purpose, without the express written permission of Yealink(Xiamen) Network Technology CO., LTD.

Technical Support

Visit Yealink WIKI (<http://support.yealink.com/>) for firmware downloads, product documents, FAQ, and more. For better service, we sincerely recommend you to use Yealink Ticketing system (<https://ticket.yealink.com>) to submit all your technical issues.



YEALINK(XIAMEN) NETWORK TECHNOLOGY CO.,LTD.
Web: www.yealink.com
Addr: No.1 Ling-Xia North Road, High Tech Park,
Huli District, Xiamen, Fujian, P.R.C
Copyright©2022 Yealink Inc. All right reserved.