



PD-96XXGC/PD-95XXGC

Multiport Series User Guide

Introduction

Microchip's family of Power over Ethernet Midspans (PoE) PD-96XXGC/AC and PD-95XXGC/AC inject power over data-carrying Ethernet cabling. Employing these devices reduces the need for AC outlets, local UPS, and AC/DC adapters near Powered Devices (PDs).

PD-9x06GC, PD-9x12GC, and PD-9x24GC/AC Midspans support 6, 12, and 24 ports respectively, in a 10/100/1000BaseTx Ethernet network, over TIA/EIA-568 category 5/5e/6 cabling. PD-96xxGC and PD-95xxGC family devices can provide up to 90 W and 60 W respectively according to the new IEEE[®] 802.3bt standards. DC power is supplied over both spare and data pairs of wires within a cable (1/2, 3/6, 4/5, and 7/8) to terminal units.

PoE Midspan normally powers devices that are PoE enabled or are equipped to receive power over Ethernet. These devices are called Powered Devices (PDs).

PoE Midspans offer the following important features.

- Safe and reliable power over an existing Ethernet infrastructure.
- Remote management using web control and/or SNMPv3.
- High-level of network security.
- Safe solution that protects network infrastructure.
- Standards compliant: IEEE 802.3bt.
- Provides safe Power and Data over a single RJ45 cable.

Table of Contents

Introduction.....	1
1. Standards and Safety Guidelines.....	4
1.1. Part Number Definition.....	4
1.2. Electrical Compatibility Approvals.....	4
1.3. Safety Standard Approvals.....	4
1.4. CE Marking.....	4
2. Safety Information.....	5
2.1. General Guidelines.....	5
2.2. Warnings.....	5
2.3. Power Cord.....	5
2.4. Country-wise Power Cord Specifications.....	6
3. Information en matière de sécurité.....	7
3.1. Directives générales.....	7
3.2. Mises en garde.....	7
4. 10/100/1000BASE-TX Ports Definition.....	8
4.1. Data Input Ports.....	8
4.2. Data and Power Output Ports.....	8
4.3. Indicators.....	8
4.4. Power Indicator LED.....	8
4.5. Port Indications.....	8
4.6. Connectors.....	10
5. PoE Midspan Installation.....	11
5.1. Background Information.....	11
5.2. Verifying Kit Contents.....	11
5.3. Rack Mounting Brackets.....	11
5.4. Installation Factors.....	12
5.5. Connecting Ethernet Cables.....	12
5.6. Connecting Power Cables.....	12
5.7. Powering Up the Unit.....	13
6. Troubleshooting.....	14
6.1. Preliminary Steps.....	14
6.2. Troubleshooting Steps.....	14
7. Specifications.....	16
7.1. Physical Specifications.....	16
8. Microchip's PowerView Pro.....	17
9. Power Backup and Power Redundancy Connection.....	18
9.1. Power Redundancy.....	18
9.2. Power Backup.....	18
9.3. Connectors.....	18

10. Contacting Technical Support..... 22

11. Revision History..... 23

The Microchip Website..... 24

Product Change Notification Service..... 24

Customer Support..... 24

Microchip Devices Code Protection Feature..... 24

Legal Notice..... 25

Trademarks..... 25

Quality Management System..... 26

Worldwide Sales and Service..... 27

1. Standards and Safety Guidelines

The following sections mention the standard and safety guidelines for the product.

1.1 Part Number Definition

PD-96xxGC/AC and PD-95xxGC/AC: 4 Pairs AC and DC input family.

Table 1-1. Part Number Definition

Symbol	Description
xx	Represents the number of ports (6, 12, or 24).
AC	Midspan has AC input (24 and 12 ports units also have DC input).

1.2 Electrical Compatibility Approvals

Microchip PD-96xxGC/AC and PD-95xxGC/AC series complies with the following standards:

- FCC Part 15: Class B UTP cabling
- EN 55032: Class B with UTP cabling
- EN 55024 (CISPR 24)
- Canadian ICES-003, Class B
- VCCI

1.3 Safety Standard Approvals

Microchip meets the following safety standards:

- UL/IEC/EN 62368-1

Note: Consult Microchip for a complete list of safety certifications.

1.4 CE Marking

CE marking on this product indicates that this product complies with the Electromagnetic Compatibility (EMC) Directive and Low Voltage Directive (LVD).

2. Safety Information

Read the following safety information before using the PoE Midspan unit.

2.1 General Guidelines

Read the following safety information before carrying out any installation, removal, or maintenance procedure on the PoE Midspan. Warnings contain directions to be followed for the safety of personal and product.

2.2 Warnings

- Read installation instructions in [5. PoE Midspan Installation](#) before connecting Midspan to its power source.
- Read instructions in [5. PoE Midspan Installation](#) before connecting Midspan-to-Midspan power backup.
- Only trained and qualified personnel must be allowed to install, replace, and service this equipment.
- Midspan must be connected using a grounded power cord, as defined in [2.3 Power Cord](#).
- This ITE device must be connected to PoE (power supply over Ethernet) networks only, without routing to other networks.
- The power cord must not be attached to the surface of the building or pass-through walls, ceilings, floors, and similar openings in the building structure.
- Steps must be taken to prevent physical damage to the power cord, including proper routing.
- This product relies on building installation for short-circuit (over-current) protection. Use only a fuse or circuit breaker not higher than 15 A for 120 V_{AC} (U.S.) or 10 A for 230 V_{AC} (international).
- All wiring and connections must conform to NFPA 70 (NEC)
- Do not work on the system or connect or disconnect cables during lightning storms.
- A voltage mismatch can damage the equipment and can pose a fire hazard. If voltage indicated on the label is different from the power outlet voltage, do not connect Midspan to this outlet.
- For shelf-mounted equipment, verify that surface is stable and strong enough to support the equipment. Do not stack more than **four** Midspan units.
- While disposing this product, follow all local laws and regulations.
- **Data** and **Data and Power** ports of the Midspan are shielded RJ45 data sockets. They cannot be used as Plain Old Telephone Service (POTS) sockets. Only connect RJ45 data connectors to these sockets.
- Associated Ethernet wiring must be limited to the inside of the building.

2.3 Power Cord

To replace the power cord, ensure to meet the local requirements.

- To ensure a reliable connection to an AC mains supply, the equipment provides an appliance IEC60320 inlet to connect a detachable power supply cord.
- Power socket outlet must be located near Midspan and easily accessible.
Note: The only way to power OFF the unit is to disconnect the power cord from the outlet.
- This unit operates under Safety Extra Low Voltage (SELV) conditions, according to IEC/EN60950-1 or ES1 according to IEC/EN 62368-1. Conditions are maintained only if the equipment to which the unit is connected also operates under SELV/ES1 conditions.

2.4 Country-wise Power Cord Specifications

U.S.A. and Canada	<ul style="list-style-type: none">• Cord must be UL-approved or CSA certified.• Minimum specification for flexible cord is:<ul style="list-style-type: none">– No. 18 AWG– Type SV or SJ– Three-conductor• Cord set must have a rated current capacity of at least 13 A.• Attachment plug must be an earth-grounding type with a NEMA 5-15P (15A, 125V) or NEMA 6-15P (15 A, 250 V) configuration.
Denmark	Supply plug must comply with section 107-2-D1, standard DK2-1a, or DK2-5a.
Switzerland	Supply plug must comply with SEV/ASE 1011.
France and Peru	IT supplies cannot power this unit. If your supplies are an IT type, the unit must be powered by 230 V (2P+T) via an isolation transformer with a 1:1 ratio, and with secondary connection point labeled Neutral and connected directly to ground.
U.K.	PoE Midspan is covered by General Approval NS/G/12345/J/100003, for indirect connection to a public telecommunications system.

3. Information en matière de sécurité

Lire les informations suivantes en matière de sécurité avant d'utiliser d'activer l'alimentation sur votre appareil Ethernet Midspan.

3.1 Directives générales

Lire les informations suivantes en matière de sécurité avant d'installer ou enlever quoi que ce soit, ou procéder à l'entretien de l'alimentation de votre appareil Ethernet Midspan. Les mises en garde contiennent des instructions qui doivent être suivies pour la sécurité des personnes et du produit. Suivre les instructions soigneusement.

3.2 Mises en garde

- Lire les instructions d'installation dans la cette [5. PoE Midspan Installation](#) avant de connecter le Midspan à une source d'alimentation.
- Lire les instructions d'installation dans la cette [5. PoE Midspan Installation](#) avant de connecter le Midspan à une source de sauvegarde Midspan.
- Seul du personnel formé et qualifié doit être autorisé à installer, remplacer et entretenir cet équipement.
- Le Midspan doit être connecté au moyen d'une corde d'alimentation avec prise de terre, comme précisé à la [2.3 Power Cord](#).
- Cet ITE appareil doit être branché à des réseaux PoE (alimentation électrique par Ethernet) seulement, et ce, sans routage vers d'autres réseaux.
- Le cordon d'alimentation ne doit pas être fixé à la surface du bâtiment ni traverser les murs, les plafonds, les planchers et les ouvertures similaires de la structure du bâtiment.
- Des mesures doivent être prises pour éviter tout dommage physique au cordon d'alimentation, y compris un acheminement approprié.
- Ce produit dépend de l'installation électrique de l'immeuble pour une protection contre les courts-circuits (surcharges de courant). Utiliser seulement un fusible ou un disjoncteur dont la puissance ne dépasse pas 15 A pour 120 V_{AC} (É.-U.), ou 10 A pour 230 V_{AC} (international).
- Tout le câblage et les connexions doivent être conformes à la norme NFPA 70 (NEC)
- Ne pas exécuter de travaux sur le système, connecter ou déconnecter des câbles pendant les orages.
- Une disparité de voltage peut endommager l'équipement et constituer un risque d'incendie. Si le voltage indiqué sur l'étiquette est différent du voltage de la source d'alimentation, ne pas connecter le Midspan à cette prise.
- Pour un équipement monté sur une tablette, vérifier que la surface est stable et suffisamment solide pour le supporter. Ne jamais empiler plus de **quatre** unités Midspan.
- Pour disposer/jeter ce produit, suivre les lois et règlements locaux.
- Les ports **Data** et **Data et Power** du PoE Midspan sont des prises de données blindées RJ45. Elles ne peuvent pas être utilisées comme prises de service téléphonique traditionnel. Connecter seulement des connecteurs de données RJ45 à ces prises. Le câblage Ethernet connexe doit être limité à l'intérieur de l'immeuble.
- Le câblage Ethernet associé doit être limité à l'intérieur du bâtiment.

4. 10/100/1000BASE-TX Ports Definition

The following sections detail PD-96xxGC and PD-95xxGC ports and their functions.

4.1 Data Input Ports

Midspan has 6, 12, or 24 10/100/1000Base-T Data In ports, located on PoE front panel (see [Figure 4-1](#)), configured in a non-crossover manner (straight-wired).

These ports are designed to carry Ethernet data only (Tx/Rx) over:

- Standard 4-wire pairs (pins 1/2, 3/6, 4/5, and 7/8) (1000BASE-T)
- 2-wire pairs (pins 1/2 and 3/6) (10/100BASE-T)

4.2 Data and Power Output Ports

Midspan has 6, 12, or 24 10/100/1000Base-T **Data & Power Out** ports, located on the front panel, as shown in the following figure. These ports are configured in a non-crossover manner (straight-wired) and carry Ethernet data over:

- Standard 4-wire pairs (pins 1/2, 3/6, 4/5, and 7/8) (1000BASE-T).
- 2-wire pairs (pins 1/2 and 3/6) (10/100BASE-T).
- PD-96xxGC/AC and PD-95xxGC/AC series carry DC power over 4-wire pairs (pins 4/5, 7/8 and pins 1/2, 3/6).

Note: PoE Midspan is not a repeater. Therefore, maximum distance from the Ethernet switch must not exceed 100 meters (328 ft). PoE Midspan is guaranteed to work only within this distance, as specified in IEEE 802.3bt standards.

Figure 4-1. Front-View (PD-9X12G) of PoE Midspan

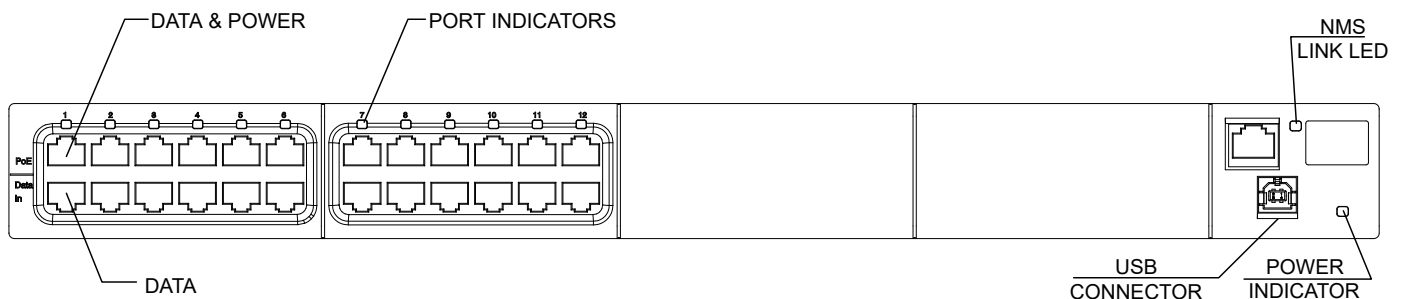

4.3 Indicators

A set of indicators displays the status of the PoE Midspan and its ports. For more information about the status information during operation, see [Table 4-1](#) and [Table 4-2](#).

4.4 Power Indicator LED

Power Indicator LED on front panel displays the power status of PoE Midspan. When the LED is illuminated in green, it indicates that the Midspan is receiving AC power. For more information, see [Table 4-1](#).

4.5 Port Indications

The following sections detail the PD-96xxGC and PD-95xxGC port indicators.

4.5.1 PD-96xxGC/AC and PD-95xxGC/AC Midspan Series

A bi-color (green and yellow) indicator per port indicates the port status.

PD-96XXGC/PD-95XXGC

10/100/1000BASE-TX Ports Definition

- Green indicates terminal unit (PD) has been identified as **Power over Ethernet Enabled**. It is active and receiving power over 4-wire pairs.
- Yellow indicates that the terminal unit (PD) has been identified as **Power over Ethernet Enabled**. It is active and receiving power over 2-wire pairs.
- Blinking green indicates that the port does not supply power and is inactive.

Note: PDs that are not PoE-enabled devices are not powered by Midspan.

The following table lists power status indications.

Table 4-1. Power Status Indications

Indicator	Color	Main Power Status	Remarks
Power Indicator	OFF	Power supply unit is unplugged.	—
	Green	Power input is active.	Power supply voltage is within limits.
	Green light blinks once every second (only if power backup is connected).	Midspan power supply failure (disconnected or out of voltage range).	Unit receives backup power and continues to function normally. Maintenance measures must be taken whenever possible.

Table 4-2. Port Status Indications PD-96xx Series

Port LED Color	Port Load Conditions	Port Voltage
OFF	Inactive load or unplugged port.	Power to port is disconnected. DC voltage is not present on port output lines.
Green	Active load is plugged in and complies with normal load conditions.	Continuous nominal DC voltage is present according to 4-pairs configuration.
Yellow	Active load is plugged in and complies with normal load conditions.	Continuous nominal DC voltage is present on 2-wire pairs.
Green blinks once every second	Overload or short circuit.	Power to port is disconnected. DC voltage is not present on port output lines.
Green blinks once every 0.5 seconds	Valid load. Total aggregated power exceeds pre-defined power budget.	Power is not connected to port. DC voltage is not present on port output lines.

4.6 Connectors

On the front panel of Midspan, there is a Console port. Using a standard USB cable (USB Type B connector), users can connect a terminal to this port and load software.

Note: USB connection requires CP210x Driver.exe installation. To install the USB driver, see www.silabs.com/developers/usb-to-uart-bridge-vcp-drivers

The Console port is set to 38,400-baud for managed units and 19,200-baud for unmanaged units, 8 data bits, no parity, and 1 stop bit.

Figure 4-2. Connecting to Midspan

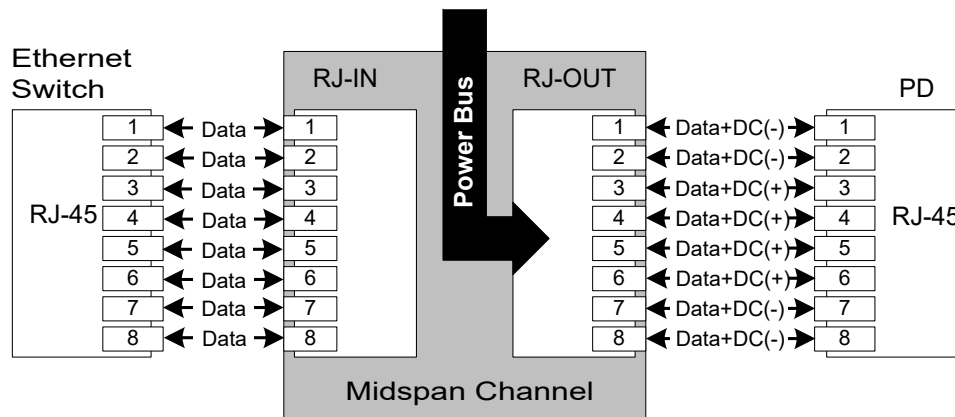

Each data port is configured as data **Pass-Through** ports for all data pins (pins 1, 2, 3, 6, 4, 5, 7, and 8). Use cabling of Category 5 or higher.

5. PoE Midspan Installation

The following sections describe how to install a Midspan.

5.1 Background Information

Midspan is connected in series to an Ethernet switch/hub, as shown in the following figure. Switch's data output terminals are connected to Midspan. Midspan delivers power over 4-wire twisted pairs (pins 7/8, 4/5 and pins 1/2, 3/6) in PD-96xxGC/AC and PD-95xxGC/AC series of Category 5e cabling, regardless of data quality. Most installations require Midspan to be rack-mounted.

Figure 5-1. Typical Installation

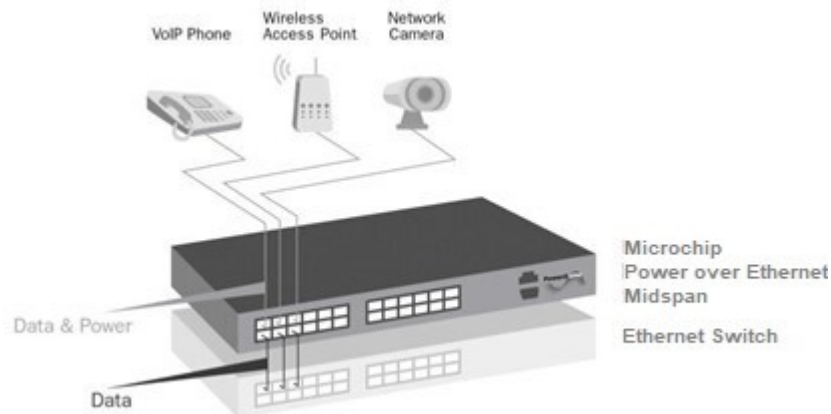

5.2 Verifying Kit Contents

Unpack the kit and verify that the following items are included.

- PoE Midspan
- Mounting brackets (for 19-inch racks)
- Screws for assembling the mounting brackets
- Self-adhesive rubber feet
- User guide

Before proceeding, record the serial number of the unit in the following rectangle for future reference. Serial number is found on the information label behind the PoE Midspan.

Figure 5-2. Serial Number

5.3 Rack Mounting Brackets

Midspan comes with 19-inch mounting brackets and screws. To install Midspan into a 19-inch rack:

1. Remove the self-adhesive rubber feet from the bottom surface.
2. Install the brackets using three screws per side.

Note: Rack-mounting screws are not provided.

Figure 5-3. Installing Mounting Brackets

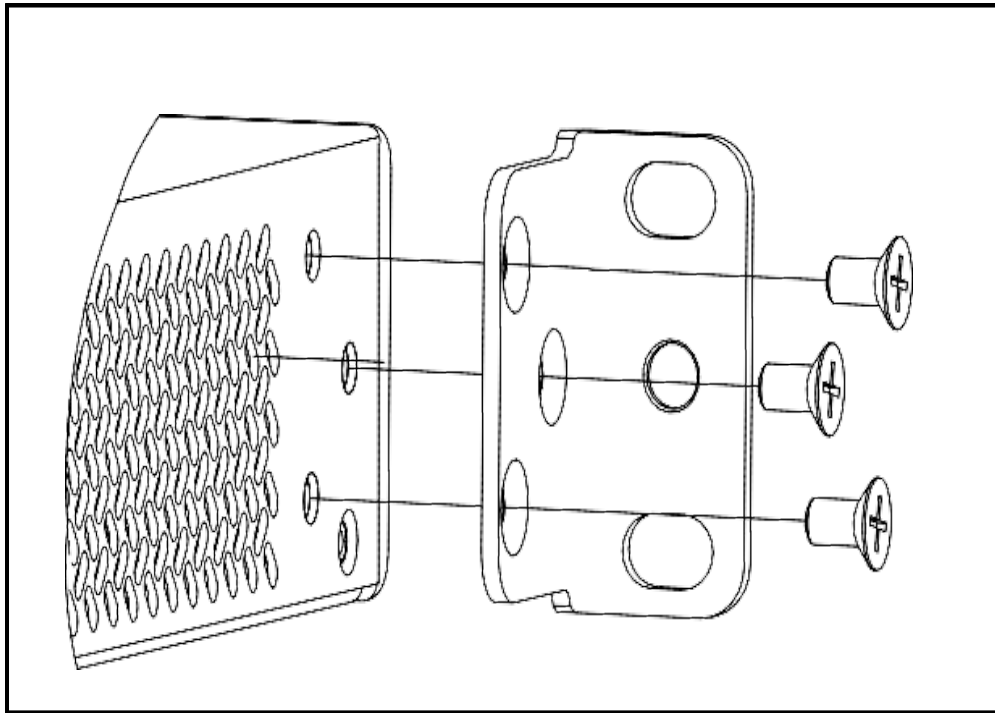

5.4 Installation Factors

Follow the installation factors carefully:

- **Elevated Operating Ambient Temperature:** If installed in a closed or multi-unit rack assembly, operating ambient temperature in the direct rack environment might be greater than the room ambient temperature. Therefore, install equipment in an environment compatible with manufacturer's maximum rated ambient temperature (T_{mra}).
- **Reduced Air Flow:** Install equipment in a rack in a manner that does not compromise the airflow required for safe operation of the equipment.
- **Mechanical Loading:** While mounting equipment on a rack, ensure that the mechanical loading is even.
- **Circuit Overloading:** Consider the connection of the equipment to a supply circuit and the effect overloading of the circuits might have on over-current protection and supply wiring. Appropriate consideration of the equipment nameplate ratings must be given while addressing this concern.
- **Reliable Grounding (Earthing):** Maintain reliable grounding of the rack mounted equipment. Pay attention to the supply connections, other than direct connections to branch circuit (for example, using power strips).

5.5 Connecting Ethernet Cables

Ports on Midspan's front panel are configured as **Pass Through** ports for eight (1, 2, 3, 6, 4, 5, 7, 8) conductors of RJ45 connectors. Use Category 5 cabling when making connections.

1. Connect cables from the Ethernet Switch to **DATA IN** ports (lower row on front-panel).
2. Connect cables from IEEE 802.3BT ready terminals (PDs) to the corresponding **DATA & POWER OUT** ports (upper row on front-panel).

5.6 Connecting Power Cables

When using an AC source to power Midspan, plug-in the provided power cord to the back AC connector.

5.7 Powering Up the Unit

PoE Midspan has no ON/OFF switch. To apply or remove power from Midspan, insert or remove the power cable to the AC socket on the back panel of the unit.

With power applied:

- Midspan powers up.
- Internal fan operates.
- Device runs its POST, which takes less than 10 seconds. During POST, all ports are disabled and indicators illuminate in the following sequence:
 - Port indicators and power indicators illuminate in green.
 - Power indicator remains lit in green; port indicators are OFF.

Ports are now ready (enabled) for normal operation.

If LEDs are not lit, see [Troubleshooting](#).

6. Troubleshooting

The following sections describe the troubleshooting procedures to address any problems encountered with the unit.

6.1 Preliminary Steps

If there is any problem, verify the following steps:

- Power is applied to Midspan.
- A crossover-type Ethernet cable is not used.
- Ethernet cable from network is connected to **DATA** port.
- Ethernet cable to PD is connected to **Data & Power** port.
- Cable pairs are attached to their corresponding ports.

6.2 Troubleshooting Steps

The following table provides a problem and resolution sequence to assist in troubleshooting of minor operating problems. If steps given do not solve your problem, call the local dealer for further assistance.

Table 6-1. Troubleshooting Steps

Symptom	Corrective Steps
Midspan does not power-up.	<ol style="list-style-type: none"> 1. Ensure that the power cord is properly connected. 2. Verify voltage at power inlet is between 100 V_{AC} and 240 V_{AC}. 3. Remove and reapply power to the device and check indicators during power-up sequence.
A port indicator is not lit and corresponding PD does not operate.	<ol style="list-style-type: none"> 1. Verify that the port is enabled (Midspan did not detect a PD). 2. Verify that the PD is designed for Power over Ethernet operation. 3. Verify that a standard Category 5/5e/6, straight-wired cable, with four pairs is used. 4. If an external power splitter is in use, replace it with a viable splitter. 5. Verify that the PD is connected to the DATA & POWER OUTPUT port. 6. Try to reconnect the same PD to a different port on the same Midspan or on another one. If it works, there is probably a faulty output port or RJ45 connection. 7. Verify that port shutdown command was not issued through Web management.

.....continued

Symptom	Corrective Steps
End device operates, but there is no data link.	<ol style="list-style-type: none"><li data-bbox="857 275 1419 331">1. Verify that the port indicator on the front panel is continuously lit.<li data-bbox="857 338 1403 394">2. If an external power splitter is in use, replace it with a viable splitter.<li data-bbox="857 401 1419 520">3. Verify that for this link you are using a standard UTP/FTP Category 5 straight (non-crossover) cabling, with all four pairs, and that the link is no longer than 100 meters.<li data-bbox="857 527 1419 646">4. Try to reconnect the same PD to a different port on the same Midspan or on another one. If it works, there is probably a faulty port or faulty RJ45 connection.

7. Specifications

The following sections detail the unit specifications.

7.1 Physical Specifications

Dimensions (H x W x D): 44 x 435 x 271 mm (1.75" x 17.2" x 10.7")

Table 7-1. Physical Specifications

P/N	Weight
PD-9624GC/AC PD-9612GC/AC PD-9524GC/AC PD-9512GC/AC	5 Kg (11 lbs)
PD-9606GC/AC PD-9506GC/AC	4.2 Kg (9.2 lbs)

Table 7-2. Environmental Specifications

Parameter	Value
Operating Temperature	0 °C to 40 °C (32 °F to 104 °F)
Storage Temperature	-20 °C to +70 °C (-4 °F to 158 °F)
Humidity	90 % maximum (non-condensing)

Table 7-3. Electrical Specifications

Parameter	PD-9612/24GC and PD-9512/24GC
	PD-9606GC and PD-9506GC
AC input voltage	100 V _{AC} to 240 V _{AC} at 50 Hz/60 Hz
Maximum input current	PD-9612/24GC and PD-9512/24GC—12 A PD-9606GC and PD-9506GC—5 A
Nominal output voltage	50 V _{DC} to 57 V _{DC}
Maximum output power	PD-9612/24GC and PD-9512/24GC—950 W PD-9606GC and PD-9506GC—450 W
Maximum output power per port	PD-96xxGC—90W PD-95xxGC—60W
DC input rated voltage	PD-95XXGC/AC, PD-96XXGC/AC—53 V _{DC} –57 V _{DC} 
Input DC maximum current	PD-95XXGC/AC, PD-96XXGC/AC—20 A

8. Microchip's PowerView Pro

Microchip's PowerView Pro is a secure remote management system offering real time monitoring and control, with graphical representation, status indicators, and alarms. PowerView Pro manages Midspans through an Internet browser interface or through a Network Management System (NMS). Some of the most important features is remote power enable/disable functionality on each Midspan port, supporting **hard resets** of remote terminals such as WLAN Access Points and VoIP Phones PowerView Pro, and enabling to monitor and control at network and Element levels, as shown in the following figure. For further details, see *Microchip's PowerView Pro Web Manager User Guide*.

Figure 8-1. Management Deployment

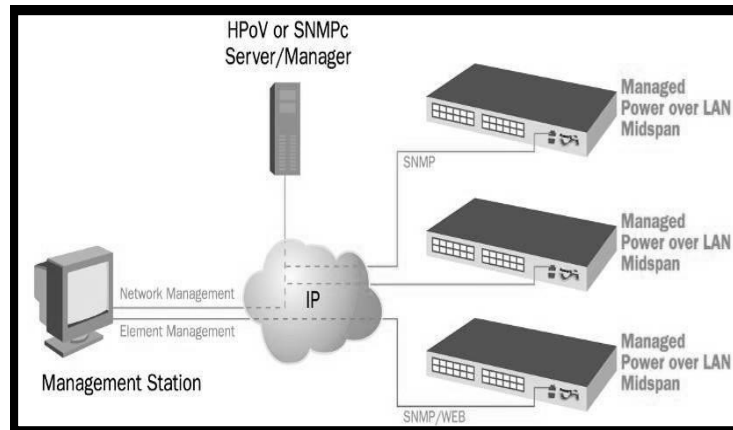

PowerView Pro provides a number of unique features for Midspan management:

- Remote Web management of PoE for monitoring and configuration.
- Configuration using graphical representations of remote devices.
- Real-time monitoring and configuration with visual status indicators and alarms.
- Multi-manager capabilities.
- Event and performance data recording.
- Runs on a PC platform with Windows GUI.

Note: The PD-96xxGC/AC and PD-95xxGC/AC Midspan comes with the PowerView Pro software pre-installed. In case the software needs to be re-installed or updated, the latest version is located in Microchip's Software Library.

9. Power Backup and Power Redundancy Connection

PD-9x24G and PD-9x12G has the following two options to ensure continuous power supply:

- Power Redundancy
- Power Backup

9.1 Power Redundancy

Microchip's power redundancy mode is available in the PD-96xxG Midspan series. This mode enables internal power supply backup for two inter-connected Midspans. This mode provides seamless failover between two Midspans. If internal power supply of one of the two Midspans fails, it is detected automatically and a working power supply is provided to the other Midspan. Both the Midspans are ensured continuous uptime and all the active ports continue to operate without any effect on the connected PDs.

Power redundancy mode is available in the following midspans:

- PD-9624GC/AC
- PD-9612GC/AC
- PD-9524GC/AC
- PD-9512GC/AC

Note: While using the power redundancy option, connect only units that share the same power supply:

- 1 Kw power supply units
 - PD-9624GC/AC
 - PD-9612GC/AC
 - PD-9524GC/AC
 - PD-9512GC/AC

9.2 Power Backup

If one of the Midspans' power supplies fails, unit maintains full functionality by using an optional backup power supply.

Table 9-1. Power Backup of PDs

Midspan Unit	Redundant Power Supply
PD-9624GC/AC, PD-9612GC/AC, PD-9524GC/AC, PD-9512GC/AC	PD-9624GC/AC, PD-9612GC/AC, PD-9524GC/AC, PD-9512GC/AC

9.3 Connectors

Power backup and power redundancy connectors are located on the back side of the Midspan.

PD-9x24GC and PD-9x12GC power backup and power redundancy have two connectors, as shown in the following figure.

- Power backup and power redundancy control signal connector, COM D-Sub: 15 pins, 3 rows female connector.
- DC voltage terminal block connector has two positive (+) terminals and two negative (-) terminals.

Figure 9-1. PD-9X24GC and PD-9X12GC Rear Panel Connectors

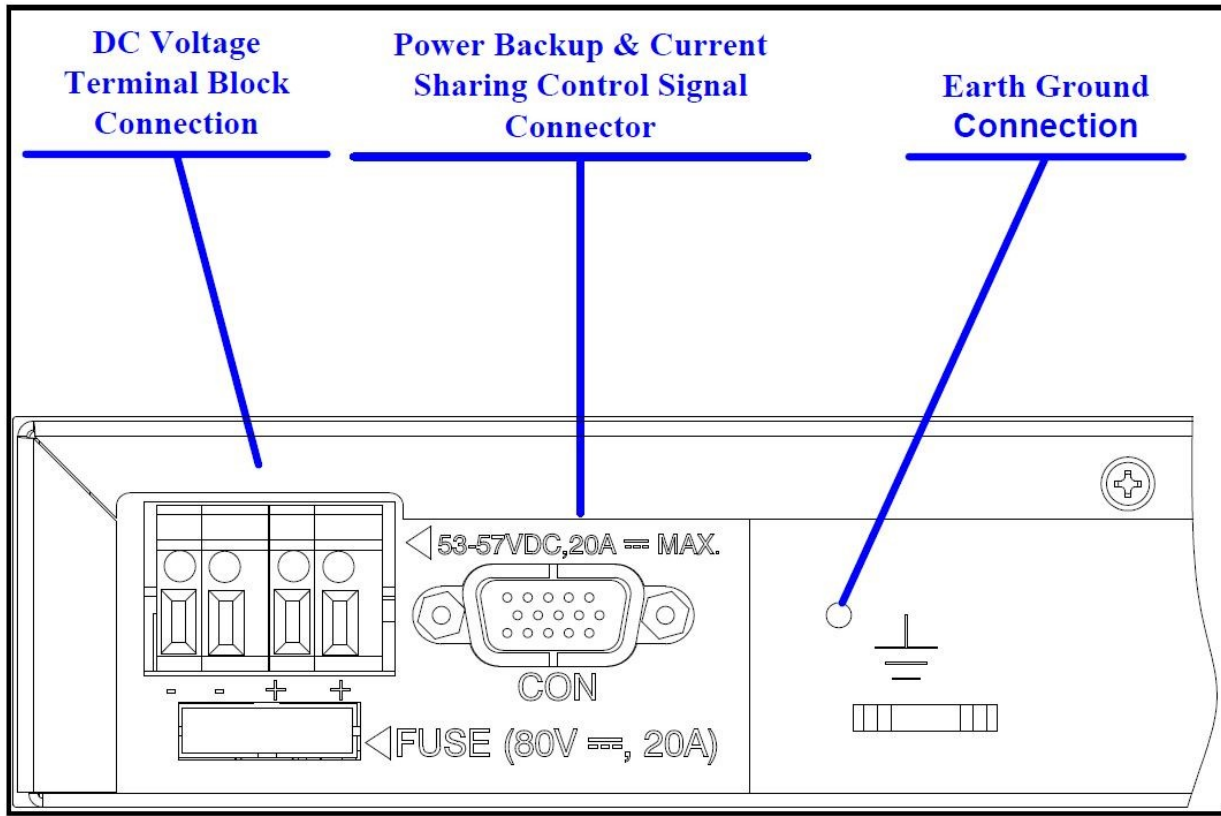

9.3.1 Connecting Backup and Redundancy Connectors



WARNING

Before connecting one Midspan to another, disconnect both Midspans from the AC mains.

Implement Power Backup and Power Redundancy modes by using cable kit, which includes a DC cable and a signal COM.

To connect the connectors:

1. Verify that the Midspans are mounted securely on the rack.
2. Verify that the Midspans are not connected to the AC mains.
3. Connect DC cable; two red wires (+), two black wires (-), and one yellow/green wire, as shown in the following figure.
4. Connect COM cable.
5. Connect Midspans to an AC outlet.
6. Verify that the power indicator LED is ON (Green LED).

Note: When connecting a midspan to another midspan, connect the earth ground cable between both units Earth Ground connection.

PD-96XXGC/PD-95XXGC

Power Backup and Power Redundancy Connection

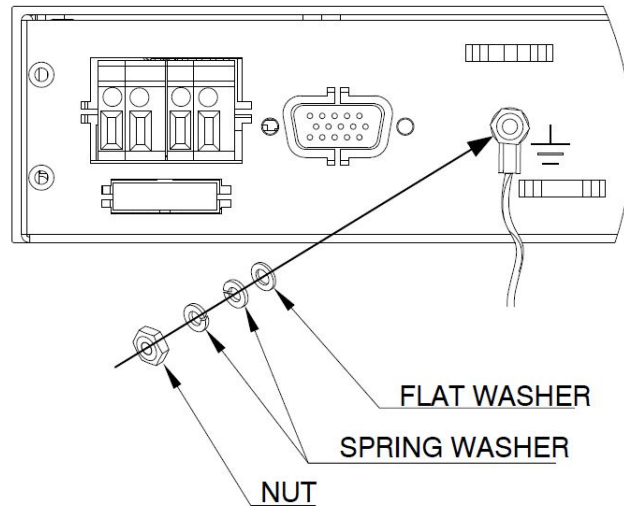

Notes:

1. If power indicator LED is not lit, see [6. Troubleshooting](#).
2. Backup functionality can be monitored through NMS, as described in [Figure 4-2](#).
3. Consult Microchip for information on DC and COM cables.

Figure 9-2. PD-9x24-10G and PD-9x12-10G Rear Panel Connections

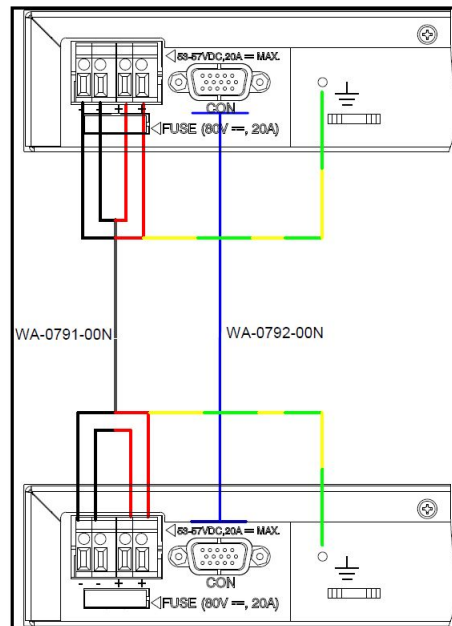

9.3.2 Power Backup and Power Redundancy Indications

For information on NMS configuration, see *PowerView Pro User Guide*. During Power Backup and Power Redundancy, NMS View-Status window displays **Power Source Status** field. **Power Source Status** field shows both internal and external power supply statuses (green indication for **OK** and red indication for **Fail**).

PD-96XXGC/PD-95XXGC

Power Backup and Power Redundancy Connection

Figure 9-3. PD-9X12GC View-Status in NMS

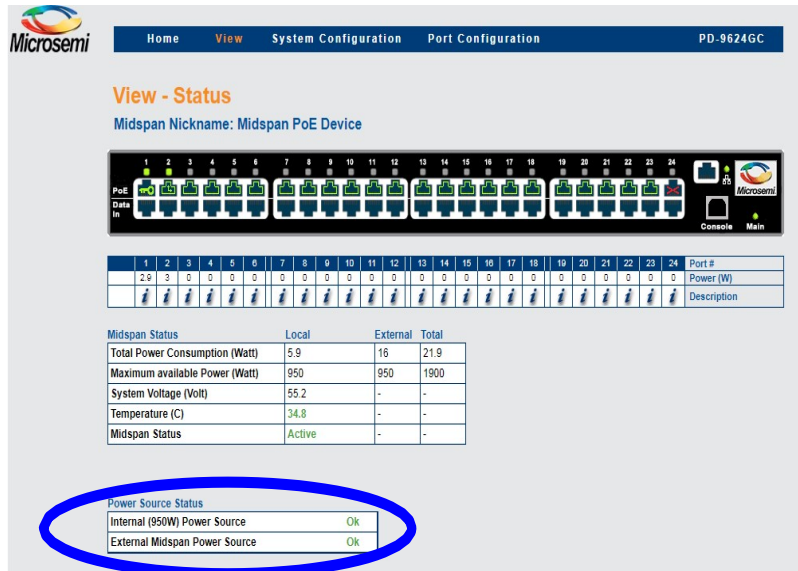

Note: Midspan provides another power fail indication through Midspan's power indicator LED. Whenever unit's internal power supply fails, power indicator LED blinks once every second (Green LED).

Figure 9-4. PD-95XXGC and PD-96XXGC Front Panel LED Indication

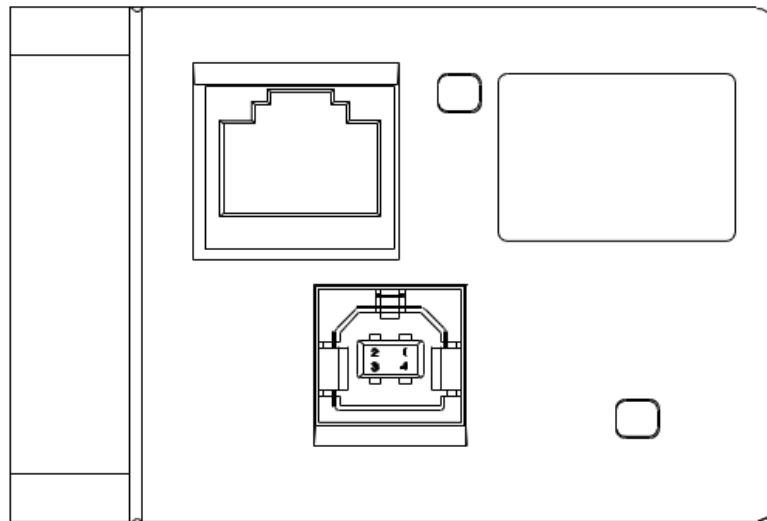

10. Contacting Technical Support

If you encounter any problems while installing or using this product, consult the Microchip technical support team through the website or contact on the following number:

USA/Canada

Telephone: +1 877 480 2323

Internet: www.microchip.com/support

11. Revision History

Revision	Date	Description
A	07/2021	Initial revision

The Microchip Website

Microchip provides online support via our website at www.microchip.com/. This website is used to make files and information easily available to customers. Some of the content available includes:

- **Product Support** – Data sheets and errata, application notes and sample programs, design resources, user's guides and hardware support documents, latest software releases and archived software
- **General Technical Support** – Frequently Asked Questions (FAQs), technical support requests, online discussion groups, Microchip design partner program member listing
- **Business of Microchip** – Product selector and ordering guides, latest Microchip press releases, listing of seminars and events, listings of Microchip sales offices, distributors and factory representatives

Product Change Notification Service

Microchip's product change notification service helps keep customers current on Microchip products. Subscribers will receive email notification whenever there are changes, updates, revisions or errata related to a specified product family or development tool of interest.

To register, go to www.microchip.com/pcn and follow the registration instructions.

Customer Support

Users of Microchip products can receive assistance through several channels:

- Distributor or Representative
- Local Sales Office
- Embedded Solutions Engineer (ESE)
- Technical Support

Customers should contact their distributor, representative or ESE for support. Local sales offices are also available to help customers. A listing of sales offices and locations is included in this document.

Technical support is available through the website at: www.microchip.com/support

Microchip Devices Code Protection Feature

Note the following details of the code protection feature on Microchip devices:

- Microchip products meet the specifications contained in their particular Microchip Data Sheet.
- Microchip believes that its family of products is secure when used in the intended manner and under normal conditions.
- There are dishonest and possibly illegal methods being used in attempts to breach the code protection features of the Microchip devices. We believe that these methods require using the Microchip products in a manner outside the operating specifications contained in Microchip's Data Sheets. Attempts to breach these code protection features, most likely, cannot be accomplished without violating Microchip's intellectual property rights.
- Microchip is willing to work with any customer who is concerned about the integrity of its code.
- Neither Microchip nor any other semiconductor manufacturer can guarantee the security of its code. Code protection does not mean that we are guaranteeing the product is "unbreakable." Code protection is constantly evolving. We at Microchip are committed to continuously improving the code protection features of our products. Attempts to break Microchip's code protection feature may be a violation of the Digital Millennium Copyright Act. If such acts allow unauthorized access to your software or other copyrighted work, you may have a right to sue for relief under that Act.

Legal Notice

Information contained in this publication is provided for the sole purpose of designing with and using Microchip products. Information regarding device applications and the like is provided only for your convenience and may be superseded by updates. It is your responsibility to ensure that your application meets with your specifications.

THIS INFORMATION IS PROVIDED BY MICROCHIP "AS IS". MICROCHIP MAKES NO REPRESENTATIONS OR WARRANTIES OF ANY KIND WHETHER EXPRESS OR IMPLIED, WRITTEN OR ORAL, STATUTORY OR OTHERWISE, RELATED TO THE INFORMATION INCLUDING BUT NOT LIMITED TO ANY IMPLIED WARRANTIES OF NON-INFRINGEMENT, MERCHANTABILITY, AND FITNESS FOR A PARTICULAR PURPOSE OR WARRANTIES RELATED TO ITS CONDITION, QUALITY, OR PERFORMANCE.

IN NO EVENT WILL MICROCHIP BE LIABLE FOR ANY INDIRECT, SPECIAL, PUNITIVE, INCIDENTAL OR CONSEQUENTIAL LOSS, DAMAGE, COST OR EXPENSE OF ANY KIND WHATSOEVER RELATED TO THE INFORMATION OR ITS USE, HOWEVER CAUSED, EVEN IF MICROCHIP HAS BEEN ADVISED OF THE POSSIBILITY OR THE DAMAGES ARE FORESEEABLE. TO THE FULLEST EXTENT ALLOWED BY LAW, MICROCHIP'S TOTAL LIABILITY ON ALL CLAIMS IN ANY WAY RELATED TO THE INFORMATION OR ITS USE WILL NOT EXCEED THE AMOUNT OF FEES, IF ANY, THAT YOU HAVE PAID DIRECTLY TO MICROCHIP FOR THE INFORMATION. Use of Microchip devices in life support and/or safety applications is entirely at the buyer's risk, and the buyer agrees to defend, indemnify and hold harmless Microchip from any and all damages, claims, suits, or expenses resulting from such use. No licenses are conveyed, implicitly or otherwise, under any Microchip intellectual property rights unless otherwise stated.

Trademarks

The Microchip name and logo, the Microchip logo, Adaptec, AnyRate, AVR, AVR logo, AVR Freaks, BesTime, BitCloud, chipKIT, chipKIT logo, CryptoMemory, CryptoRF, dsPIC, FlashFlex, flexPWR, HELDO, IGLOO, JukeBlox, KeeLoq, Klear, LANCheck, LinkMD, maXStylus, maXTouch, MediaLB, megaAVR, Microsemi, Microsemi logo, MOST, MOST logo, MPLAB, OptoLyzer, PackeTime, PIC, picoPower, PICSTART, PIC32 logo, PolarFire, Prochip Designer, QTouch, SAM-BA, SenGenuity, SpyNIC, SST, SST Logo, SuperFlash, Symmetricom, SyncServer, Tachyon, TimeSource, tinyAVR, UNI/O, Vectron, and XMEGA are registered trademarks of Microchip Technology Incorporated in the U.S.A. and other countries.

AgileSwitch, APT, ClockWorks, The Embedded Control Solutions Company, EtherSynch, FlashTec, Hyper Speed Control, HyperLight Load, IntelliMOS, Libero, motorBench, mTouch, Powermite 3, Precision Edge, ProASIC, ProASIC Plus, ProASIC Plus logo, Quiet-Wire, SmartFusion, SyncWorld, Temux, TimeCesium, TimeHub, TimePictra, TimeProvider, WinPath, and ZL are registered trademarks of Microchip Technology Incorporated in the U.S.A.

Adjacent Key Suppression, AKS, Analog-for-the-Digital Age, Any Capacitor, AnyIn, AnyOut, Augmented Switching, BlueSky, BodyCom, CodeGuard, CryptoAuthentication, CryptoAutomotive, CryptoCompanion, CryptoController, dsPICDEM, dsPICDEM.net, Dynamic Average Matching, DAM, ECAN, Espresso T1S, EtherGREEN, IdealBridge, In-Circuit Serial Programming, ICSP, INICnet, Intelligent Paralleling, Inter-Chip Connectivity, JitterBlocker, maxCrypto, maxView, memBrain, Mindi, MiWi, MPASM, MPF, MPLAB Certified logo, MPLIB, MPLINK, MultiTRAK, NetDetach, Omniscient Code Generation, PICDEM, PICDEM.net, PICKit, PICtail, PowerSmart, PureSilicon, QMatrix, REAL ICE, Ripple Blocker, RTAX, RTG4, SAM-ICE, Serial Quad I/O, simpleMAP, SimpliPHY, SmartBuffer, SMART-I.S., storClad, SQL, SuperSwitcher, SuperSwitcher II, Switchtec, SynchroPHY, Total Endurance, TSHARC, USBCheck, VariSense, VectorBlox, VeriPHY, ViewSpan, WiperLock, XpressConnect, and ZENA are trademarks of Microchip Technology Incorporated in the U.S.A. and other countries.

SQTP is a service mark of Microchip Technology Incorporated in the U.S.A.

The Adaptec logo, Frequency on Demand, Silicon Storage Technology, and Symmcom are registered trademarks of Microchip Technology Inc. in other countries.

GestIC is a registered trademark of Microchip Technology Germany II GmbH & Co. KG, a subsidiary of Microchip Technology Inc., in other countries.

All other trademarks mentioned herein are property of their respective companies.

© 2021, Microchip Technology Incorporated, Printed in the U.S.A., All Rights Reserved.

ISBN: 978-1-5224-8578-0

Quality Management System

For information regarding Microchip's Quality Management Systems, please visit www.microchip.com/quality.

Worldwide Sales and Service

AMERICAS	ASIA/PACIFIC	ASIA/PACIFIC	EUROPE
<p>Corporate Office 2355 West Chandler Blvd. Chandler, AZ 85224-6199 Tel: 480-792-7200 Tel: 480-792-7277 Technical Support: www.microchip.com/support Web Address: www.microchip.com</p> <p>Atlanta Duluth, GA Tel: 678-957-9614 Fax: 678-957-1455</p> <p>Austin, TX Tel: 512-257-3370</p> <p>Boston Westborough, MA Tel: 774-760-0087 Fax: 774-760-0088</p> <p>Chicago Itasca, IL Tel: 630-285-0071 Fax: 630-285-0075</p> <p>Dallas Addison, TX Tel: 972-818-7423 Fax: 972-818-2924</p> <p>Detroit Novi, MI Tel: 248-848-4000</p> <p>Houston, TX Tel: 281-894-5983</p> <p>Indianapolis Noblesville, IN Tel: 317-773-8323 Fax: 317-773-5453 Tel: 317-536-2380</p> <p>Los Angeles Mission Viejo, CA Tel: 949-462-9523 Fax: 949-462-9608 Tel: 951-273-7800</p> <p>Raleigh, NC Tel: 919-844-7510</p> <p>New York, NY Tel: 631-435-6000</p> <p>San Jose, CA Tel: 408-735-9110 Tel: 408-436-4270</p> <p>Canada - Toronto Tel: 905-695-1980 Fax: 905-695-2078</p>	<p>Australia - Sydney Tel: 61-2-9868-6733</p> <p>China - Beijing Tel: 86-10-8569-7000</p> <p>China - Chengdu Tel: 86-28-8665-5511</p> <p>China - Chongqing Tel: 86-23-8980-9588</p> <p>China - Dongguan Tel: 86-769-8702-9880</p> <p>China - Guangzhou Tel: 86-20-8755-8029</p> <p>China - Hangzhou Tel: 86-571-8792-8115</p> <p>China - Hong Kong SAR Tel: 852-2943-5100</p> <p>China - Nanjing Tel: 86-25-8473-2460</p> <p>China - Qingdao Tel: 86-532-8502-7355</p> <p>China - Shanghai Tel: 86-21-3326-8000</p> <p>China - Shenyang Tel: 86-24-2334-2829</p> <p>China - Shenzhen Tel: 86-755-8864-2200</p> <p>China - Suzhou Tel: 86-186-6233-1526</p> <p>China - Wuhan Tel: 86-27-5980-5300</p> <p>China - Xian Tel: 86-29-8833-7252</p> <p>China - Xiamen Tel: 86-592-2388138</p> <p>China - Zhuhai Tel: 86-756-3210040</p>	<p>India - Bangalore Tel: 91-80-3090-4444</p> <p>India - New Delhi Tel: 91-11-4160-8631</p> <p>India - Pune Tel: 91-20-4121-0141</p> <p>Japan - Osaka Tel: 81-6-6152-7160</p> <p>Japan - Tokyo Tel: 81-3-6880-3770</p> <p>Korea - Daegu Tel: 82-53-744-4301</p> <p>Korea - Seoul Tel: 82-2-554-7200</p> <p>Malaysia - Kuala Lumpur Tel: 60-3-7651-7906</p> <p>Malaysia - Penang Tel: 60-4-227-8870</p> <p>Philippines - Manila Tel: 63-2-634-9065</p> <p>Singapore Tel: 65-6334-8870</p> <p>Taiwan - Hsin Chu Tel: 886-3-577-8366</p> <p>Taiwan - Kaohsiung Tel: 886-7-213-7830</p> <p>Taiwan - Taipei Tel: 886-2-2508-8600</p> <p>Thailand - Bangkok Tel: 66-2-694-1351</p> <p>Vietnam - Ho Chi Minh Tel: 84-28-5448-2100</p>	<p>Austria - Wels Tel: 43-7242-2244-39 Fax: 43-7242-2244-393</p> <p>Denmark - Copenhagen Tel: 45-4485-5910 Fax: 45-4485-2829</p> <p>Finland - Espoo Tel: 358-9-4520-820</p> <p>France - Paris Tel: 33-1-69-53-63-20 Fax: 33-1-69-30-90-79</p> <p>Germany - Garching Tel: 49-8931-9700</p> <p>Germany - Haan Tel: 49-2129-3766400</p> <p>Germany - Heilbronn Tel: 49-7131-72400</p> <p>Germany - Karlsruhe Tel: 49-721-625370</p> <p>Germany - Munich Tel: 49-89-627-144-0 Fax: 49-89-627-144-44</p> <p>Germany - Rosenheim Tel: 49-8031-354-560</p> <p>Israel - Ra'anana Tel: 972-9-744-7705</p> <p>Italy - Milan Tel: 39-0331-742611 Fax: 39-0331-466781</p> <p>Italy - Padova Tel: 39-049-7625286</p> <p>Netherlands - Drunen Tel: 31-416-690399 Fax: 31-416-690340</p> <p>Norway - Trondheim Tel: 47-72884388</p> <p>Poland - Warsaw Tel: 48-22-3325737</p> <p>Romania - Bucharest Tel: 40-21-407-87-50</p> <p>Spain - Madrid Tel: 34-91-708-08-90 Fax: 34-91-708-08-91</p> <p>Sweden - Gothenberg Tel: 46-31-704-60-40</p> <p>Sweden - Stockholm Tel: 46-8-5090-4654</p> <p>UK - Wokingham Tel: 44-118-921-5800 Fax: 44-118-921-5820</p>