



User Guide

AV1000 2-port Gigabit Passthrough
Powerline Adapter
TL-PA7027P

Contents

About This Guide	1
Chapter 1. Get to Know Your Powerline Adapter	2
1.1. Product Overview.....	3
1.2. Product Appearance.....	3
Chapter 2. Use Your Powerline Adapter.....	5
2.1. Before You Start	6
2.2. Extend Your Wired Network by Plug & Play	7
2.3. Secure Your Powerline Network by Pairing.....	8
2.4. Add Another Powerline Adapter.....	9
2.5. Manage Your Powerline Network via tpPLC Utility.....	10
FAQ (Frequently Asked Questions)	11

About This Guide

This guide is a complement to Quick Installation Guide. The Quick Installation Guide provides instructions for quick internet setup, while this guide contains details of each function and demonstrates how to configure them in typical scenarios.

When using this guide, please notice that features of the powerline adapter may vary slightly depending on the model and software version you have. The powerline adapter availability may also vary by region or ISP. All images, steps, and descriptions in this guide are only examples and may not reflect your actual powerline adapter experience.

*Compatible with all HomePlug AV and AV2 Standard Powerline adapters. This product may not be compatible with routers or gateways with firmware that has been altered, is based on open source programs, or are non-standard or outdated.

*Maximum wireless signal rates are the physical rates derived from IEEE Standard 802.11 specifications. Actual wireless data throughput and wireless coverage are not guaranteed and will vary as a result of network conditions, client limitations, and environmental factors, including building materials, obstacles, volume and density of traffic, and client location.

*Maximum Powerline signal rates are the physical rates derived from HomeplugAV/AV2 specifications. Actual Powerline data throughput and Powerline range are not guaranteed and will vary as a result of network conditions and environmental factors, including electrical interference, volume of traffic and network overhead, AFCI circuit breaker, and Powerline being located in a separate circuit.

* The Power Saving feature takes effect when your appliances are disconnected or turned off. Actual power saving data will vary in different network conditions and environments.

Conventions

In this guide, the following conventions are used:

Convention	Description
<u>Teal Underlined</u>	Hyperlinks are in teal and underlined. You can click to redirect to a website or a specific section.
Teal	Key information appears in teal, including management page text such as menus, items, buttons and so on.
■ Note:	Ignoring this type of note might result in a malfunction or damage to the device.
🔗 Tips:	Indicates important information that helps you make better use of your device.

More Info

- The latest software, management app and utility are available from the [Download Center](https://www.tp-link.com/en/support/download/) at <https://www.tp-link.com/en/support/download/>.
- The Quick Installation Guide (QIG) can be found where you find this guide or inside the product package.
- Specifications can be found on the product page at <https://www.tp-link.com>.
- A community is provided for you to discuss our products at <https://community.tp-link.com/>.
- Our Technical Support contact information can be found at the [Contact Technical Support](https://www.tp-link.com/support/) page at <https://www.tp-link.com/support/>.

Chapter 1

Get to Know Your Powerline Adapter

This chapter introduces what the powerline adapter can do and describes its appearance.

It contains the following sections:

- [Product Overview](#)
- [Product Appearance](#)

1.1. Product Overview

TP-Link powerline adapter aims to extend your existing home network, with the help of your home's electrical circuit.

The integrated power socket on the powerline adapter provides an outlet for other electronic devices. Its built-in noise filter eliminates electrical signal noise and therefore guarantees the high quality transmission of data via powerline.

1.2. Product Appearance



Your powerline adapter may differ in appearance slightly from that depicted because of the region and product version.

■ **Note:** TL-PA7027P KIT (European version) is used for demonstration in this guide

1.2.1. LED Legend



LEDs indicate the powerline adapter's working status. For more details, please refer to the following table.

Name	Status	Indication
 Power	On/Off	The powerline adapter is on or off.
	Blinking	Blinking quickly: Pairing is in process. Blinking slowly: Power-Saving Mode* is on.
 Powerline	On	The powerline adapter is successfully connected to a powerline network.
	Off	The powerline adapter is not connected to any powerline network.
 Ethernet	On	The Ethernet port is connected.
	Off	The Ethernet port is not connected.

*Five minutes after the device connected to the powerline adapter is turned off or inactive, the powerline adapter will automatically switch to Power-Saving Mode.

1.2.2. Physical Interface

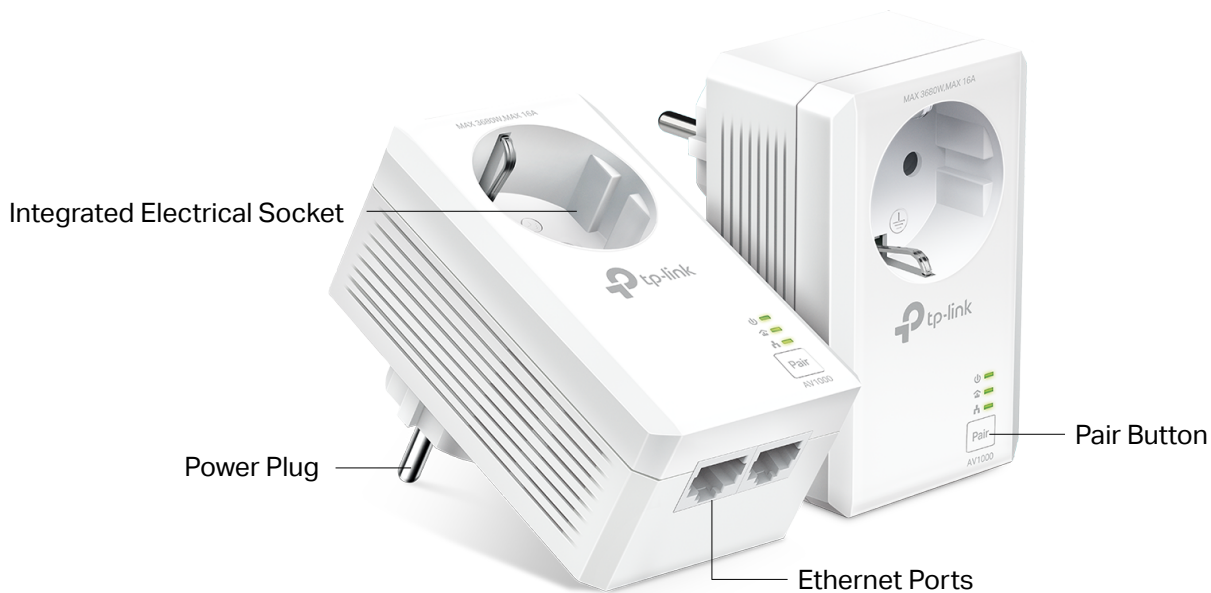

Integrated Electrical Socket

Used as an electrical outlet expansion for power strip or household appliances. It can remove some electrical noise that might affect powerline performance.

Power Plug

The powerline adapter has a Plug that can be connected to a power socket.

Pair Button

Press and hold the button for 1 second to join a powerline network. Go to [Secure Your Powerline Network by Pairing](#) for more information.

Press and hold for more than 6 seconds to reset the powerline adapter.

Ethernet Port

Connect the Ethernet port to your wired devices, such as a computer, a router or a game console, via an Ethernet cable.

Chapter 2

Use Your Powerline Adapter

This chapter guides you on how to use the powerline adapter.

It contains the following sections:

- [Before You Start](#)
- [Extend Your Wired Network by Plug & Play](#)
- [Secure Your Powerline Network by Pairing](#)
- [Add Another Powerline Adapter](#)
- [Manage Your Powerline Network via tpPLC Utility](#)

2.1. Before You Start

Powerline adapters work in pairs. You should have at least two powerline products to build a powerline network. To optimize your network performance, please follow these principles:

- All powerline adapters should be on the same electrical wiring system.
- Avoid plugging in powerline adapters and high-powered household devices (such as washing machines and refrigerators) close to one another.
- Plug the powerline adapter directly into a wall outlet. Do not plug the powerline adapter into a power strip, extension cord, or surge protector.

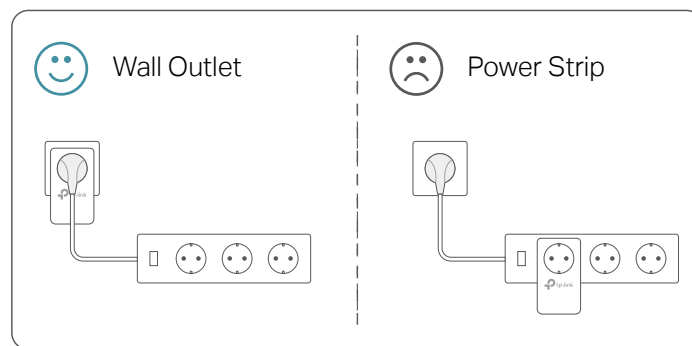

- Use the powerline adapter only in below directions.

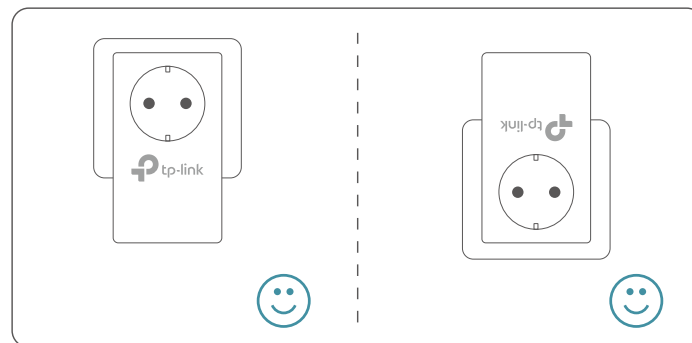

- Environment:

Operating Temperature: 0 °C ~ 40 °C (32°F ~ 104°F)

Operating Humidity: 10%~90%RH, Non-condensing

Storage Humidity: 5%~90%RH, Non-condensing

2.2. Extend Your Wired Network by Plug & Play

I want to:

Use two powerline adapters to set up a new powerline network in my house.

For example, a wall in my house is thick enough to influence the signals, but I want to bring internet to the room upstairs, to basement, garage, or the far corner of my house. I don't want complex and expensive cabling. People told me that I can solve these problems with two powerline adapters.

How can I do that?

1. Connect one of the powerline adapters to an available LAN port of the router using an Ethernet cable.
2. Plug the powerline adapter into a wall outlet.
3. Plug the other powerline adapter into a wall outlet on the same electrical circuit at the place you want internet. Wait until the powerline LED  turns on.

 **Note:** If the Powerline LED does not turn on, refer to [FAQ-Q2](#) for instructions.

4. Connect your wired device, such as a computer or game console, to the powerline adapter via an Ethernet cable.

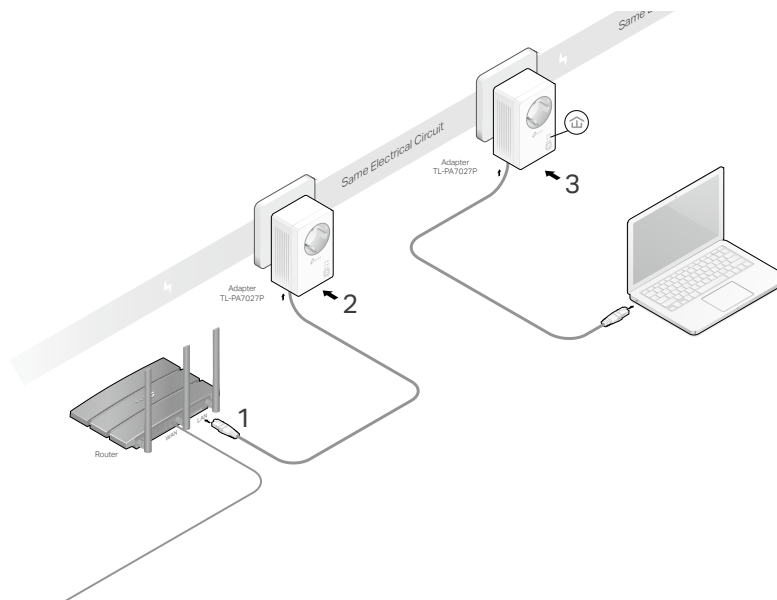

Done!

Now enjoy the internet!

2.3. Secure Your Powerline Network by Pairing

All powerline adapters share some common factory settings, and can communicate with one another. If you want your powerline adapters to communicate only with your own powerline adapters, you should pair them. Thus a secured powerline network is formed and other powerline adapters can no longer join your powerline network without being paired.

■ **Note:** You can only pair two devices at a time.

I want to:

Secure my powerline network and prevent other powerline devices from being added to my network.



For example, I've extended my network using the Plug & Play method. Now I want to secure my network.

How can I do that?

1. Verify all powerline devices' Power LEDs  are solid on.

 **Tips:** We recommend that you plug in your powerline devices next to each other, or as close to each other as possible when pairing. Your settings will not be affected. The devices can be relocated to where they are needed once pairing is complete.

2. Press the Pair button on any of the powerline devices for 1 second. Its Power LED  should start blinking.

3. (Within 2 minutes) Press the Pair button on another device for 1 second. Its Power LED  should start blinking. When the Powerline LED  lights up, a powerline network has been successfully created.

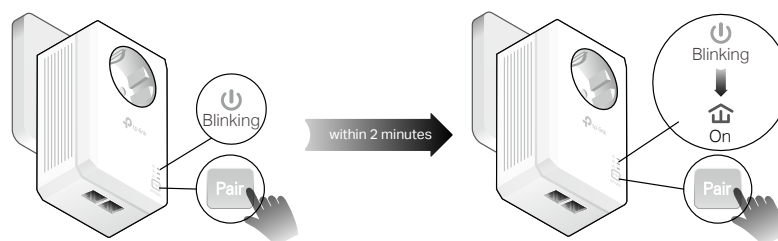

Done!

Enjoy your secure powerline network!

2.4. Add Another Powerline Adapter

I want to:





Add a new powerline adapter into the existing powerline network to extend my network.

For example, I've already set up a powerline network using powerline devices, but the network does not reach everywhere I need it to. I purchased another one to further extend my network.

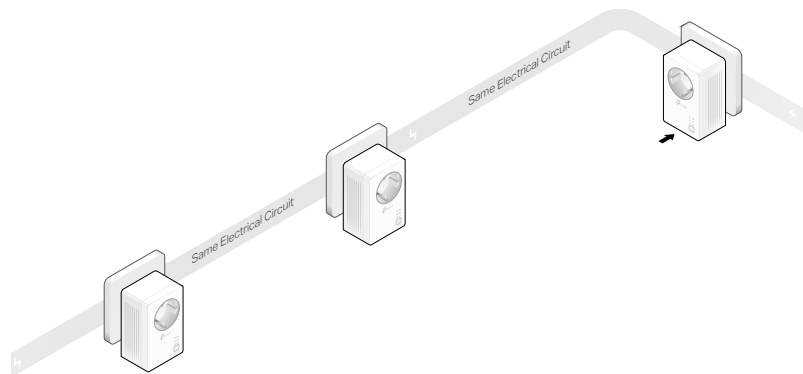
How can I do that?

1. Plug the new powerline adapter into a wall outlet near one of the existing powerline devices.



2. Wait for a minute, and check whether the Powerline LED  turns on. If it's on, skip to step 3. If it's not, continue with step 2 to pair the new powerline adapter into the secured powerline network.
 - a. Press the Pair button on one of the existing powerline devices for 1 second. Its Power LED  starts blinking.
 - b. Within 2 minutes, press the Pair button on the new powerline adapter for 1 second. Its Power LED  starts blinking. When the Powerline LED  turns on, the pairing process is complete.

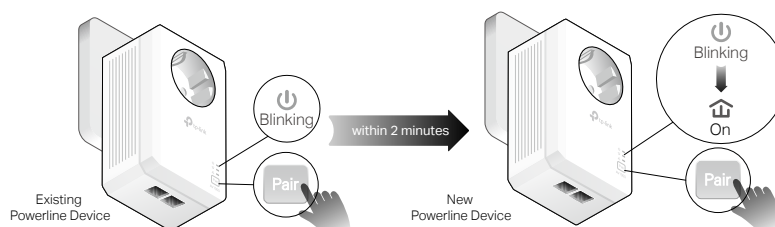

3. When the Powerline LED  turns on, it's done. Relocate the new powerline adapter to the place where wired internet access is needed.

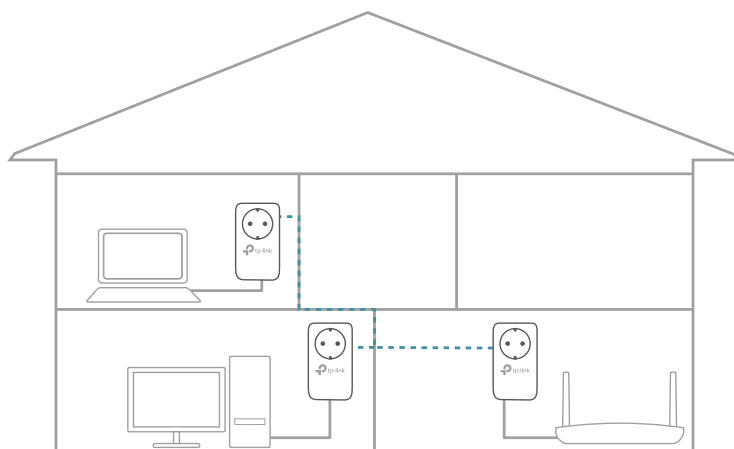

Done!

Enjoy the internet through your extended network!

2.5. Manage Your Powerline Network via tpPLC Utility

The tpPLC utility enables you to view and manage your TP-Link powerline network. Its bold and intuitive interface helps you easily configure each powerline device.

You can find the utility and its user guide on the product support page at <https://www.tp-link.com/en/support/download/>.

FAQ (Frequently Asked Questions)

Q1. How do I reset my powerline adapter?

With the powerline adapter plugged into the wall socket, press and hold its Pair button for more than 6 seconds until the Power LED  goes off momentarily and comes back on.

Q2. What should I do if the Powerline LED is off?

- Try another wall socket and make sure all powerline devices are on the same electrical circuit.
- Try to set up a powerline network by pairing. Refer to [Secure Your Powerline Network by Pairing](#) for instructions.
- Try to reset each powerline adapter to its factory default settings
- If the problem persists, contact our Technical Support.

Q3. What should I do if there is no internet connection in my powerline network?

- Make sure all powerline devices are on the same electrical circuit.
- Make sure the Powerline LEDs  are lit on all of your powerline devices. If they are not, pair all powerline devices according to [Secure Your Powerline Network by Pairing](#).
- Make sure all devices are correctly and securely connected.
- Verify that you have an internet connection by connecting your computer directly to the modem or the router.

Q4. What should I do if a successfully-paired powerline device does not reconnect after it is relocated?

- Try another socket on the same electrical circuit.
- Try to pair the device again, and make sure the Powerline LED  is on.
- Check for possible interference due to a washing machine, air conditioner or other household appliance that may be too close to one of the powerline devices. Plug the appliance into the integrated electrical socket to remove the electrical noise if your powerline device has an integrated electrical socket.
-

If you have any problem persists or any suggestions, contact our Technical Support.

For Hotline-Support, please visit:

<https://www.tp-link.com/en/support/contact-technical-support/#Hotline-Support>

For E-mail-Support, please visit:

<https://www.tp-link.com/en/support/contact-technical-support/#E-mail-Support>

COPYRIGHT & TRADEMARKS

Specifications are subject to change without notice.  tp-link is a registered trademark of TP-Link Technologies Co., Ltd. Other brands and product names are trademarks or registered trademarks of their respective holders.

No part of the specifications may be reproduced in any form or by any means or used to make any derivative such as translation, transformation, or adaptation without permission from TP-Link Technologies Co., Ltd. Copyright © 2020 TP-Link Technologies Co., Ltd. All rights reserved.

FCC compliance information statement



Product Name: AV1000 2-port Gigabit Passthrough Powerline Adapter

Model Number: TL-PA7027P

Responsible party:

TP-Link USA Corporation, d/b/a TP-Link North America, Inc.

Address: 145 South State College Blvd. Suite 400, Brea, CA 92821

Website: <http://www.tp-link.com/us/>

Tel: +1 626 333 0234

Fax: +1 909 527 6803

E-mail: sales.usa@tp-link.com

This equipment has been tested and found to comply with the limits for a Class B digital device, pursuant to part 15 of the FCC Rules. These limits are designed to provide reasonable protection against harmful interference in a residential installation. This equipment generates, uses and can radiate radio frequency energy and, if not installed and used in accordance with the instructions, may cause harmful interference to radio communications. However, there is no guarantee that interference will not occur in a particular installation. If this equipment does cause harmful interference to radio or television reception, which can be determined by turning the equipment off and on, the user is encouraged to try to correct the interference by one or more of the following measures:

- Reorient or relocate the receiving antenna.
- Increase the separation between the equipment and receiver.
- Connect the equipment into an outlet on a circuit different from that to which the receiver is connected.
- Consult the dealer or an experienced radio/ TV technician for help.

This device complies with part 15 of the FCC Rules. Operation is subject to the following two conditions:

1. This device may not cause harmful interference.
2. This device must accept any interference received, including interference that may cause undesired operation.

Any changes or modifications not expressly approved by the party responsible for compliance could void the user's authority to operate the equipment.

We, **TP-Link USA Corporation**, has determined that the equipment shown as above has been shown to comply with the applicable technical standards, FCC part 15. There

is no unauthorized change is made in the equipment and the equipment is properly maintained and operated.

Issue Date: 2020.05.08

CE Mark Warning



This is a class B product. In a domestic environment, this product may cause radio interference, in which case the user may be required to take adequate measures.

EU Declaration of Conformity

TP-Link hereby declares that the device is in compliance with the essential requirements and other relevant provisions of directives 2014/30/EU, 2014/35/EU, 2009/125/EC, 2011/65/EU and (EU)2015/863.

The original EU declaration of conformity may be found at <https://www.tp-link.com/en/ce>

Canadian Compliance Statement

This device contains licence-exempt transmitter(s)/receiver(s) that comply with Innovation, Science and Economic Development Canada's licence-exempt RSS(s). Operation is subject to the following two conditions:

- 1) This device may not cause interference
- 2) This device must accept any interference, including interference that may cause undesired operation of the device.

L'émetteur/récepteur exempt de licence contenu dans le présent appareil est conforme aux CNR d'Innovation, Sciences et Développement économique Canada applicables aux appareils radio exempts de licence. L'exploitation est autorisée aux deux conditions suivantes :

- 1) l'appareil ne doit pas produire de brouillage;
- 2) l'utilisateur de l'appareil doit accepter tout brouillage radioélectrique subi, même si le brouillage est susceptible d'en compromettre le fonctionnement.

Industry Canada Statement

CAN ICES-3 (B)/NMB-3(B)

CAN ICES-6/NMB-6

Korea Warning Statements

당해 무선설비는 운용중 전파혼신 가능성이 있음.

BSMI Notice

安全諮詢及注意事項

- 請使用本產品注明的電源類型使用本產品。
- 清潔本產品之前請先切斷電源。請勿使用液體、噴霧清潔劑或濕布進行清潔。
- 注意防潮，請勿將水或其他液體潑灑到本產品上。
- 插槽與開口供通風使用，以確保本產品的操作可靠並防止過熱，請勿堵塞或覆蓋開口。

- 請勿將本產品置放於靠近熱源的地方。除非有正常的通風，否則不可放在密閉位置中。
- 請不要私自拆開機殼或自行維修，如產品有故障請與原廠或代理商聯繫。

限用物質含有情況標示聲明書

設備名稱：AV1000 2-port Gigabit Passthrough 型號（型式）：TL-PA027P Equipment name Powerline Adapter Type designation (Type)						
單元 Unit	限用物質及其化學符號 Restricted substances and its chemical symbols					
	鉛 Lead (Pb)	汞 Mercury (Hg)	鎘 Cadmium (Cd)	六價鉻 Hexavalent chromium (Cr ⁺⁶)	多溴聯苯 Polybrominated biphenyls (PBB)	多溴二苯醚 Polybrominated diphenyl ethers (PBDE)
外殼	○	○	○	○	○	○
電源供 應板	—	○	○	○	○	○
備考 1. "超出 0.1wt%" 及 "超出 0.01wt%" 系指限用物質之百分比含量超出百分比含量基準值。 備考 2. "○" 系指該項限用物質之百分比含量未超出百分比含量基準值。 備考 3. "—" 系指該項限用物質為排除項目。						



Продукт сертифіковано згідно с правилами системи УкрСЕПРО на відповідність вимогам нормативних документів та вимогам, що передбачені чинними законодавчими актами України.





Safety Information



- Keep the device away from water, fire, humidity or hot environments.
- Do not attempt to disassemble, repair, or modify the device.
- The socket-outlet shall be installed near the equipment and shall be easily accessible
- For passthrough devices, plug the power strips into the integrated electrical sockets of the devices, but devices of the same or another type not be stacked in normal use.
- Plug the powerline devices directly into the wall outlets but not the power strips.
- Plug the powerline devices into the wall outlets with earthing connection.









Nicht hintereinander stecken

Please read and follow the above safety information when operating the device. We cannot guarantee that no accidents or damage will occur due to improper use of the device. Please use this product with care and operate at your own risk.

CAUTION:

 N
 Double pole, neutral fusing.
 Disconnect mains before servicing.

ATTENTION.

 N
 Double pôle/fusible sur le neutre.

Explanation of the symbols on the product label

Symbol	Explanation
	AC voltage
	DC voltage
	Indoor use only
	Functional earth wiring terminals only
	Warning electric shock
	Fuse is used in neutral N
	<p>RECYCLING</p> <p>This product bears the selective sorting symbol for Waste electrical and electronic equipment (WEEE). This means that this product must be handled pursuant to European directive 2012/19/EU in order to be recycled or dismantled to minimize its impact on the environment.</p> <p>User has the choice to give his product to a competent recycling organization or to the retailer when he buys a new electrical or electronic equipment.</p>