



Quick Installation Guide

Wireless Access Point

Omada EAP110/EAP115

Need setup videos?
Scan the QR code, or visit
<https://www.tp-link.com/us/support/setup-video/>



Note: EAP115 is used as an example throughout this guide. EAP110 differs in appearance.

LED Indication

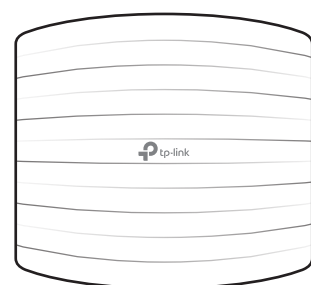

- **Solid Green**
The device is working properly.
- **Flashing Yellow, Green**
The device is updating. Do not disconnect or power off the device.
- **Flashing Yellow**
The device is working abnormally.
- **Quickly Flashing Yellow, Green**
The device is being reset to its factory default settings.

Interface Panel

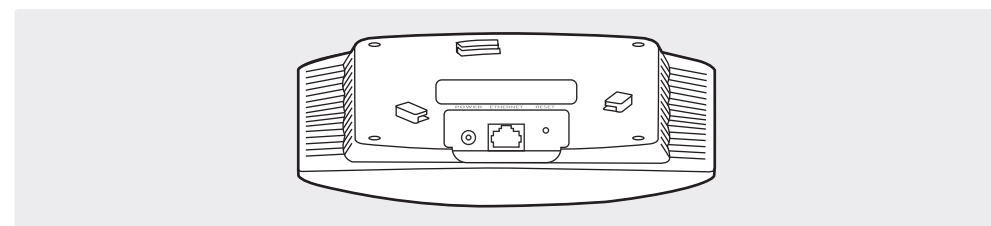

RESET
With the device powered on, press and hold the button for about 5 seconds until the LED is quickly flashing yellow then green. Then release the button. The device will restore to factory default settings.

ETHERNET
The port is used to connect to a router or a switch to transmit data, or to a PSE (Power Sourcing Equipment), such as a PoE switch, for both data transmission and Power over Ethernet (PoE) through Ethernet cable.

POWER (for EAP115 only)
Plug one end of the provided power adapter to this port and the other end to a standard electrical wall outlet to power the EAP.

Hardware Installation

The EAP can be ceiling-mounted or wall-mounted. Follow the steps below for the appropriate installation.

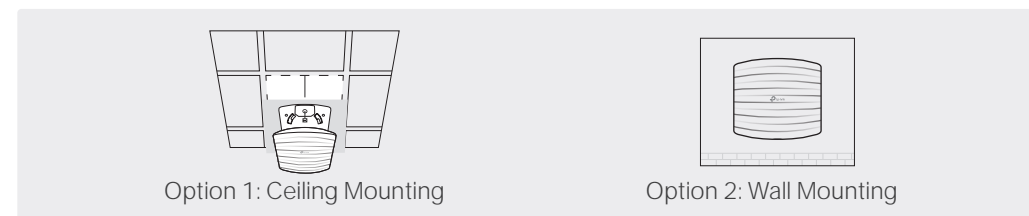

Option 1: Ceiling Mounting

Note: Make sure that the ceiling tile is bigger than the EAP.

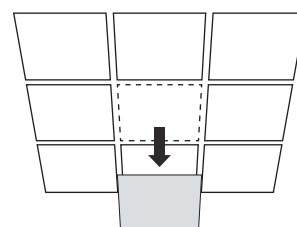
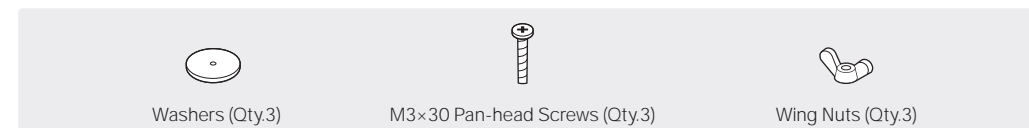

1 Remove the ceiling tile.

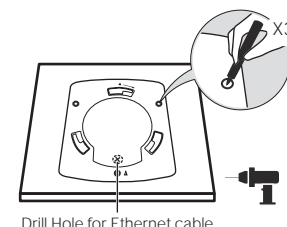

2 Place the mounting bracket in the center of the ceiling tile. Mark three positions for the screw holes and a position for the Ethernet cable hole. Drill three 4mm diameter holes for the screws and a 25mm diameter hole for the Ethernet cable at the marked positions.

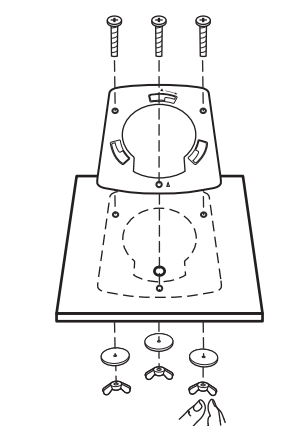

3 Secure the mounting bracket to the ceiling tile using three M3x30 pan-head screws, washers and wing nuts, as shown on the left.

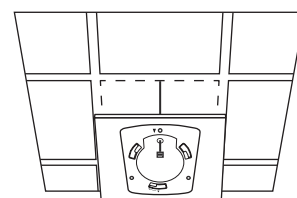

4 Feed the Ethernet cable through the hole and set the ceiling tile back into place.

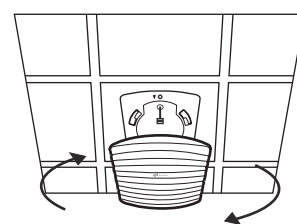

5 Connect the Ethernet cable to the ETHERNET port. Attach the EAP to the mounting bracket by aligning the arrow mark ▲ on the EAP with the arrow mark ▲ on the mounting bracket, then rotate the EAP until it locks into place, as shown on the left.

Option 2: Wall Mounting

Note: For security reasons, it is not recommended to install the EAP with the louver downward.

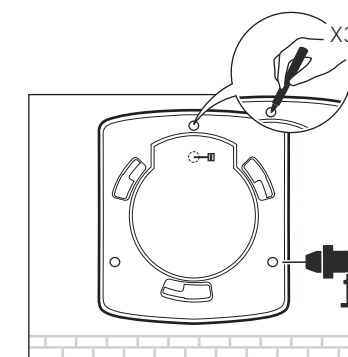
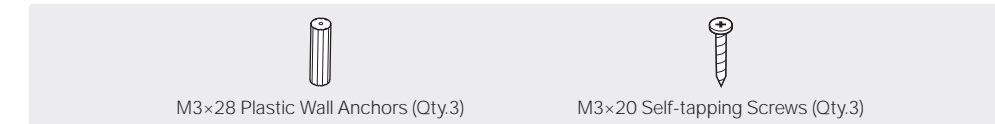

1 If your Ethernet cable feeds through the wall, you can position the mounting bracket to make the cable through the fixing hole. Mark three positions for the screw holes and then drill three 6mm diameter holes at the marked positions.

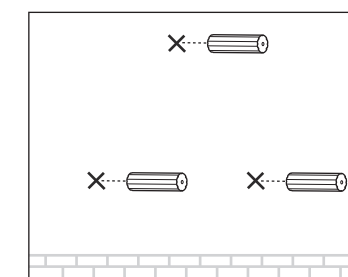

2 Insert the plastic wall anchors into the 6mm diameter holes.

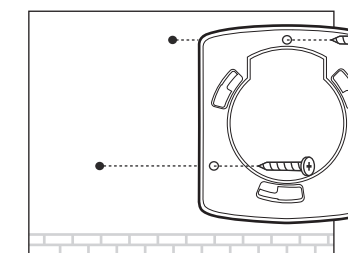

3 Secure the mounting bracket to the wall by driving the self-tapping screws into the anchors. Make sure that the shoulders of the mounting bracket are on the outside.

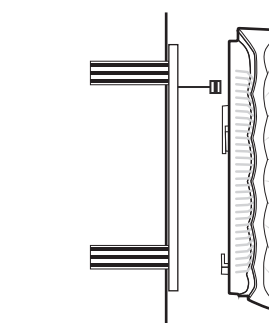

4 Connect the Ethernet cable to the Ethernet port on the EAP.

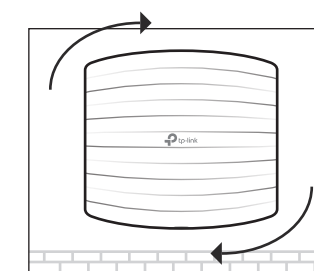

5 Attach the EAP to the mounting bracket by aligning the arrow mark ▲ on the EAP with the arrow mark ▲ on the mounting bracket, then rotate the EAP until it locks into place, as shown on the left.

Power Supply

For EAP 110

The EAP can be powered via a PoE adapter.

1. Connect an Ethernet cable from the Ethernet port of the EAP to the PoE port of the provided power adapter.
2. Connect another Ethernet cable from the LAN port of the router to the LAN port of the power adapter.
3. Connect the power cord to the adapter's power socket. Connect the other end of the power cord to a standard electrical wall outlet.

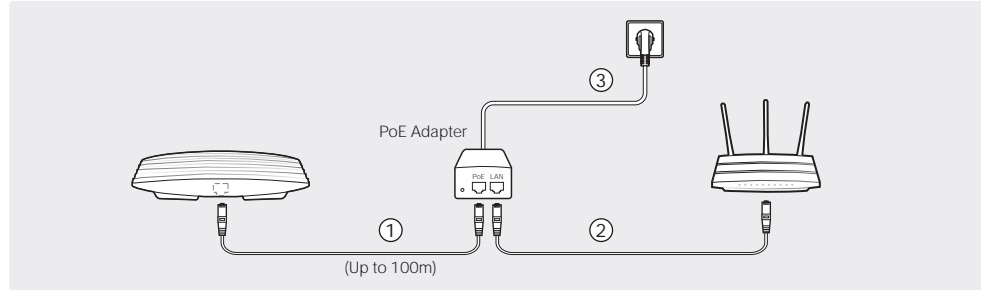

For EAP 115

• Via PoE Switch

Connect an Ethernet cable from the PoE switch to the Ethernet port.

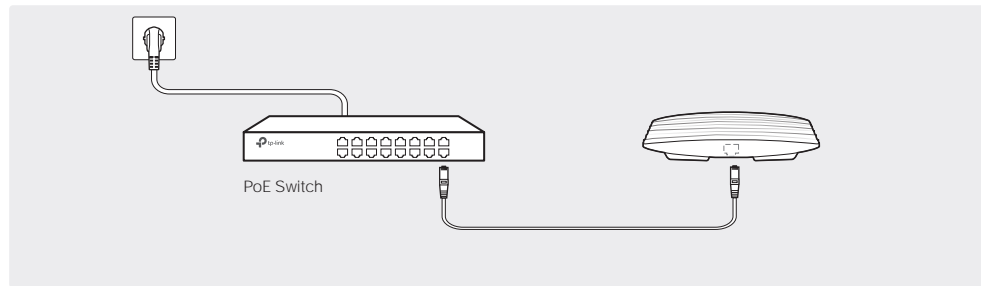

• Via Power Adapter

Plug one end of the provided power adapter into the POWER port of the EAP and the other end to a standard electrical wall outlet.

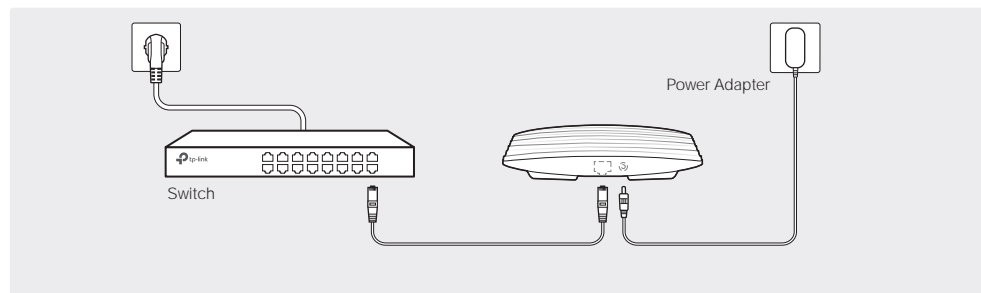

Software Configuration

A DHCP server (typically a router with DHCP function enabled) is required to assign IP addresses to the EAPs and clients in your local network.

The EAP supports two configuring options:

- To manage EAPs singly (usually suitable for a small network with a few EAPs), Standalone Mode is recommended. Please refer to Option 1.
- To manage EAPs in batch, Controller Mode is recommended. Please refer to Option 2.

Option1: Standalone Mode

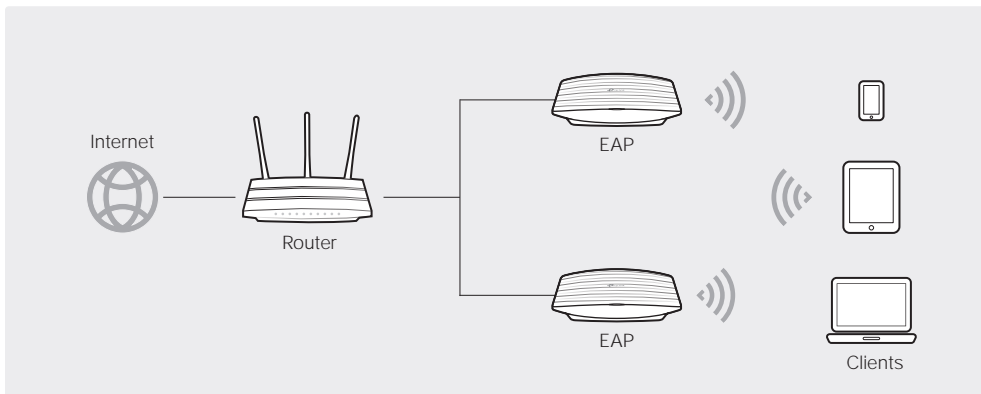

Via Omada App

1. Download the TP-Link Omada app on your mobile device. It can be downloaded from Apple Store or Google Play:



2. Connect your mobile device to the EAP by using the default SSID (format: TP-Link_2.4GHz_XXXXXX) printed on the label at the bottom of the product.
3. Open the Omada app, and wait for the EAP to appear on the Standalone APs page. Tap on the EAP you want to configure.

The Omada app is designed to help you quickly configure the common settings. If you want to configure advanced settings, log in to the web page of your EAP or the controller.

Via a Web Browser

1. Connect wirelessly by using the default SSID (format: TP-Link_2.4GHz_XXXXXX) printed on the label at the bottom of the product.
2. Launch a web browser and enter <http://tplinkeap.net> in the address bar. Use **admin** for both Username and Password to log in.
3. Set up a new Username and Password for secure management purpose. Modify the wireless parameters and reconnect your wireless devices to the new wireless network.

To configure other EAPs, connect your device to the EAP by the corresponding default SSID and repeat the steps listed above. You can configure some basic functions in Standalone Mode. If you want to configure advanced functions, use Controller Mode.

Option2: Controller Mode

Controller Mode is applicable to configuration for mass EAPs. All EAPs can be centrally configured and monitored via an Omada Software Controller or an Omada Cloud Controller (OC200).

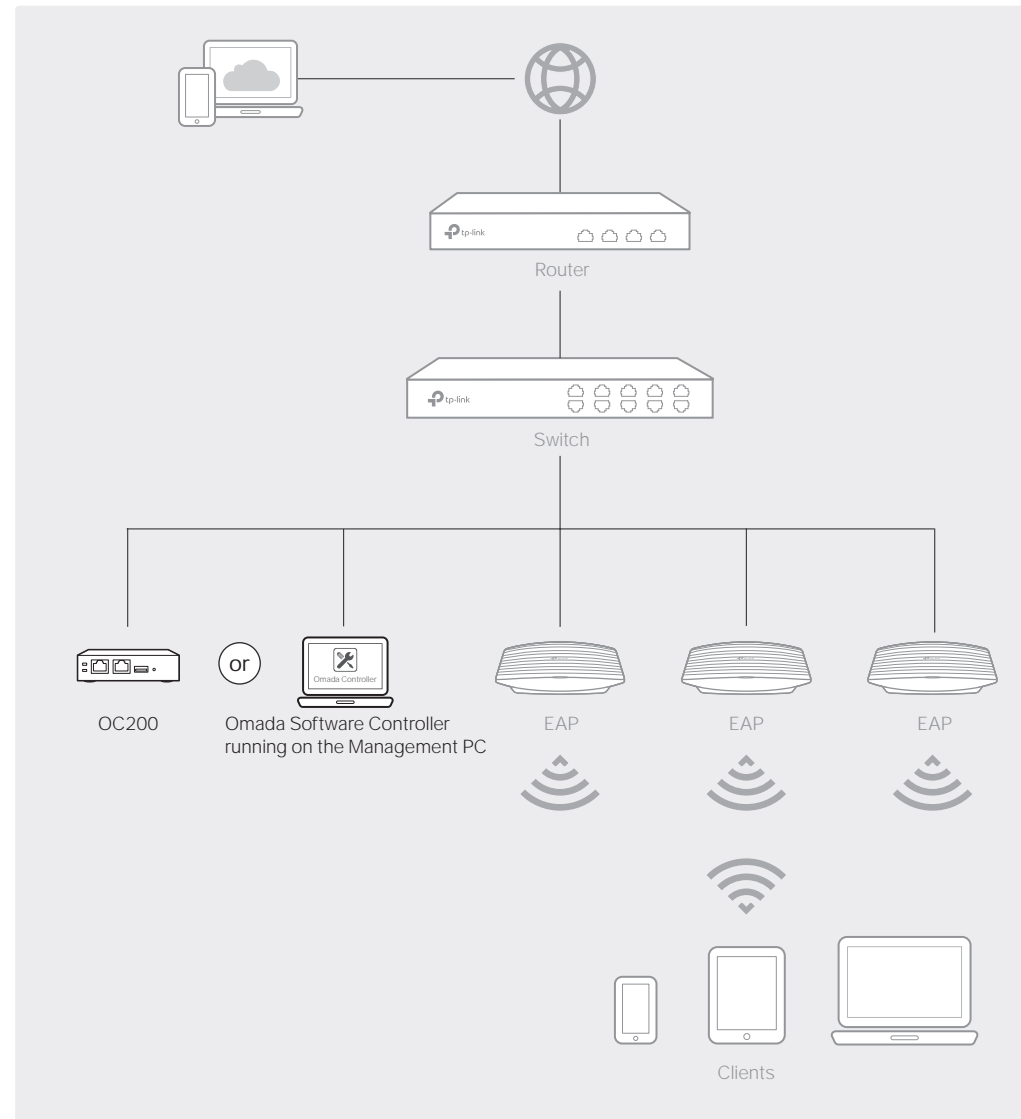

Via Software Controller

1. On the PC with Windows OS or Linux OS, download the Omada Controller installation file from <https://www.tp-link.com/download/EAP-Controller.html>.
2. Run the file and follow the wizard to install the Omada Controller.
3. Launch the Omada Controller and follow the step-by-step instructions to complete the Quick Setup. After the wizard is finished, a login screen will appear.
4. Enter the username and password you created and click **Log in**. Then you can further configure the Omada Controller.

Omada Cloud Service

After installing Omada Controller, you can remotely configure the controller through cloud service when your management device can access the internet. Follow the steps below.

1. Enable Cloud Access on the setting page on the controller and bind a TP-Link ID to your controller. If you have configured this in the setup wizard, skip the step.
2. Launch a web browser and enter <https://omada.tplinkcloud.com> in the address bar.
3. Enter your TP-Link ID and password to log in. A list of Omada Controller that has been bound with your TP-Link ID will appear. Then you can click **Launch** to further configure the controller.

* Omada App

With Omada app, you can also manage your Omada Controller at a local site and remote site. Note that Omada Software Controller needs to be kept running when using Omada app.

1. Download the TP-Link Omada app on your mobile device. It can be downloaded from Apple Store or Google Play:



2. Launch your app and configure the controller at a local site or remote site.

- Local Management
 - a. Connect your mobile device to the EAP by using the default SSID (format: TP-Link_2.4GHz_XXXXXX) printed on the label at the bottom of the product.
 - b. Launch the app and go to **Local Access**, tap the + button on the upper-right corner to add the Omada controller. Then you can further configure the controller.
- Remote Management
 - a. Make sure Cloud Access is enabled on your controller and your controller has been bound with a TP-Link ID.
 - b. Launch the app and log in with your TP-Link ID. Then go to **Cloud Access**. A list of Omada Controller that has been bound with your TP-Link ID will appear. Then you can further configure the controller.

Via OC200

Omada Cloud Controller (OC200), which is pre-installed with the Omada Software Controller, is a good alternative for the Software Controller if you have no spare PC to keep running in the network. It needs to be purchased additionally. For more details, refer to the Installation Guide of OC200.

For detailed configurations, please visit <https://www.tp-link.com/support> to download the User Guide of EAP in the download center.

To ask questions, find answers, and communicate with TP-Link users or engineers, please visit <https://community.tp-link.com> to join TP-Link Community.



The products of TP-Link partly contain software code developed by third parties, including software code subject to the GNU General Public License (GPL). As applicable, the terms of the GPL and any information on obtaining access to the respective GPL Code used in TP-Link products are available to you in GPL-Code-Centre under (<http://www.tp-link.com/en/support/gpl>). The respective programs are distributed WITHOUT ANY WARRANTY and are subject to the copyrights of one or more authors. For details, see the GPL Code and other terms of the GPL.