



D02EEJ001-00
OCE/ASA/SAF/GLF/TWN
Version 0

Quick Setup Guide



DCP-L5510DN / DCP-L5510DW / DCP-L5660DN / MFC-L5710DN / MFC-L5710DW /
MFC-L5715DW / MFC-L5915DW / MFC-L6710DW / MFC-L6720DW / MFC-L6910DN / MFC-L6915DW

Read the *Product Safety Guide* first, then read this *Quick Setup Guide* for the correct installation procedure.
Not all models are available in all countries.



Video setup instructions:
support.brother.com/videos



The latest manuals are available at the Brother support website:
support.brother.com/manuals

EN

Unpack the machine and check the components

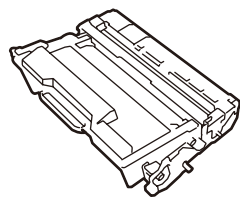
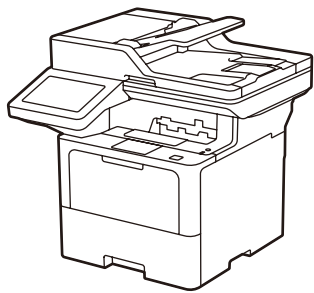

Toner Cartridge and Drum Unit Assembly
(Installed in the machine)



AC Power Cord



USB Port Cover
(Not included in all models)

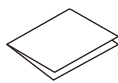

Quick Setup Guide

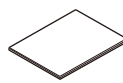

Product Safety Guide

NOTE:

- The components included in the box may differ depending on your country.
- The available connection interfaces vary depending on the model. You must purchase the correct interface cable if you require one.
 - **USB cable**
We recommend using a USB 2.0 cable (Type A/B) that is no more than 2 metres long.
 - **Network cable**
Use a straight-through Category 5 (or greater) twisted-pair cable.
- The screens and images in this *Quick Setup Guide* show the MFC-L6915DW.

1 Remove the packing materials and re-install the toner cartridge and drum unit assembly

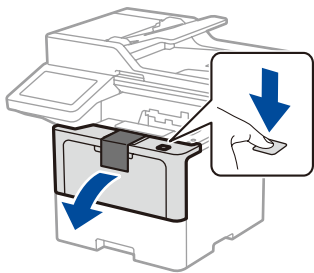

Discard the silica gel pack.

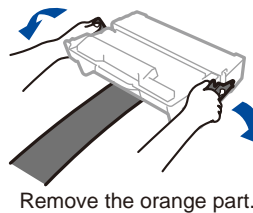
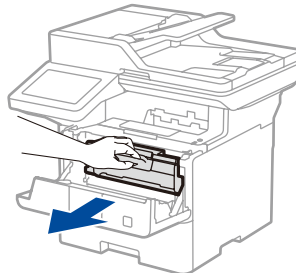
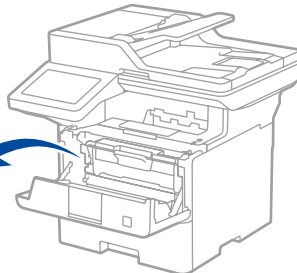

Remove the orange part.

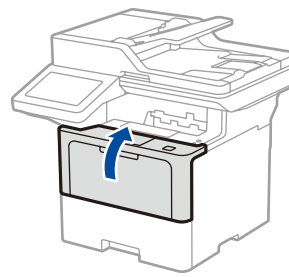
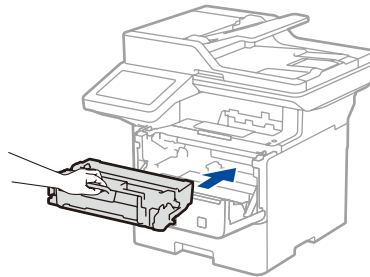
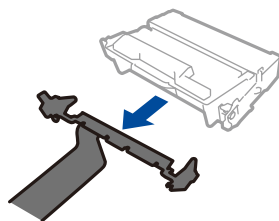

2 Load paper in the paper tray

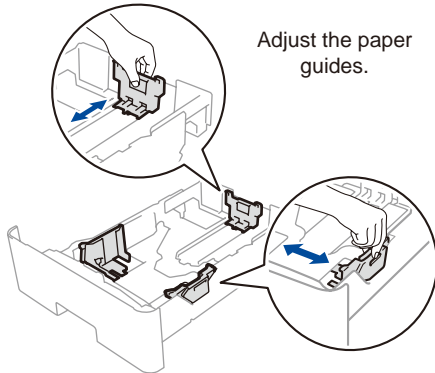
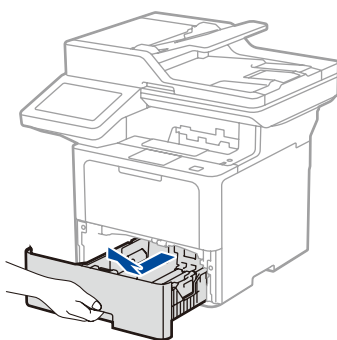

Adjust the paper guides.

Do not exceed this mark.

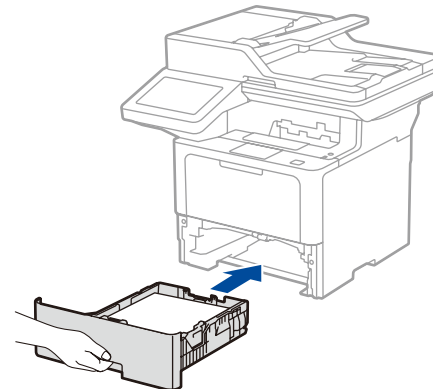
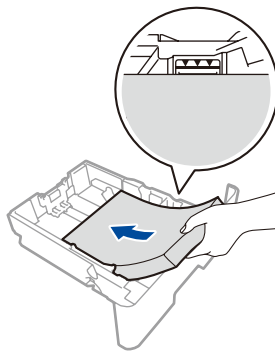

3 Connect the power cord and turn the machine on

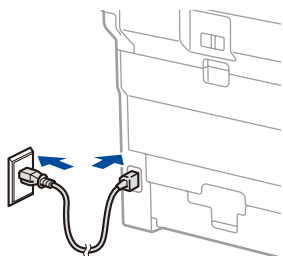

Back

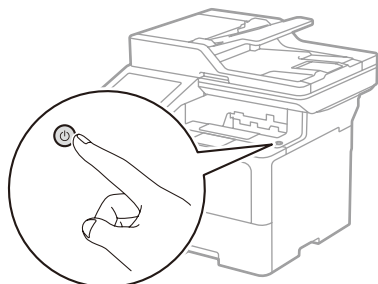

Front

4 Select your country/language (Initial setup only)

After turning the machine on, you may be required to set your country or language (depending on your machine).
If required, follow the on-screen instructions.



5 Select your language (if needed)

1. On the machine's touchscreen, press [Settings]* > [All Settings] > [Initial Setup] > [Local Language].
2. Press your language.
3. Press .

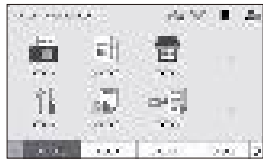

* If your machine displays the [All Settings] menu on the Home screen, start from [All Settings].

6 Connect the telephone line cord (For MFC models)

If you do not plan to use the fax feature on this machine, go to step **7**.

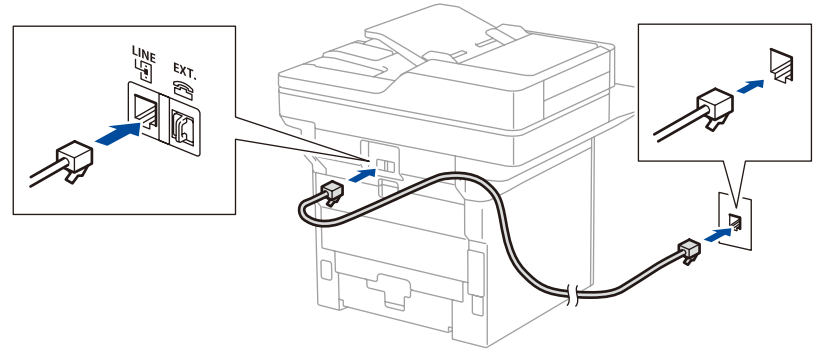

7 Connect your computer or mobile device to your machine

Follow these steps to complete the setup using one of the connection types available on your machine.

Visit setup.brother.com to download and install Brother software.

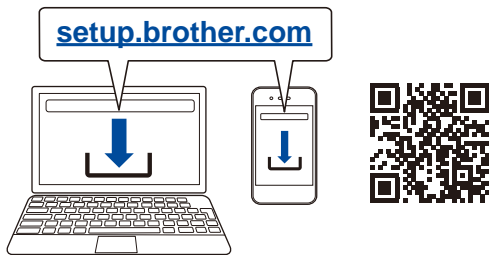

NOTE:
For Windows only, CD installation is also available (for some countries).

Follow the on-screen instructions and prompts.

Setup Finished

You can now print and scan using your machine.

To check for the latest firmware, visit support.brother.com/up7.

Important Notice for Network Security:

The default password to manage this machine's settings is located on the back of the machine and marked "Pwd". We recommend immediately changing the default password to protect your machine from unauthorised access.

Can't Connect? Check the following:

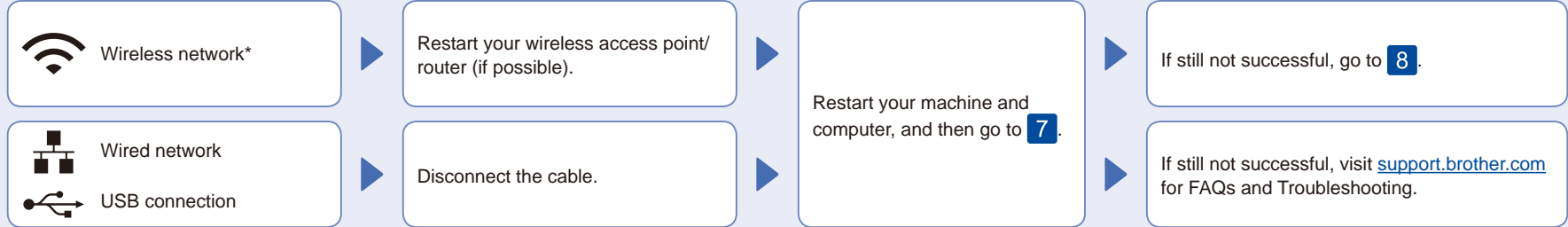

* For certain models, the wireless network connection can be used only when the optional Wireless Module is installed.

8 Manual wireless setup (Wireless models)

If the wireless setup is not successful, try to set up the connection manually.
For certain models, the wireless network connection can be used only when the optional Wireless Module is installed.

Find your SSID (Network Name) and Network Key (Password) on your wireless access point/router and write them in the table provided below.

SSID (Network Name)	
Network Key (Password)	

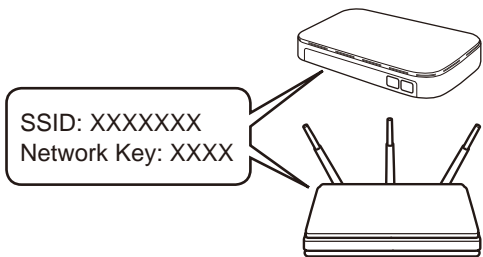

Press > [Find Wi-Fi Network].
Follow the LCD instructions.



Select the SSID (Network Name) for your access point/router and enter the Network Key (Password).

When the wireless setup is successful, the touchscreen displays [Connected].

Go to **7** to install software.

If setup is not successful, restart your Brother machine and your wireless access point/router, and repeat **8**.
If still not successful, visit support.brother.com.

If you cannot find this information, ask your network administrator or wireless access point/router manufacturer.