

REPUBLIC OF GAMERS WIRELESS GAMING KEYBOARD XA12 ROG STRIX SCOPE II RX

ROG STRIX SCOPE II RX

ROG STRIX SCOPE II RX

ROG STRIX SCOPE II RX

ROG STRIX SCOPE II RX

ROG STRIX SCOPE II RX

ROG STRIX SCOPE II RX

ROG STRIX SCOPE II RX

ROG STRIX SCOPE II RX

ROG STRIX SCOPE II RX

ROG STRIX SCOPE II RX

ROG STRIX SCOPE II RX

ROG STRIX SCOPE II RX

ROG STRIX SCOPE II RX

ROG STRIX SCOPE II RX

ROG STRIX SCOPE II RX

ROG STRIX SCOPE II RX

ROG STRIX SCOPE II RX

ROG STRIX SCOPE II RX

ROG STRIX SCOPE II RX

ROG STRIX SCOPE II RX

ROG STRIX SCOPE II RX

ROG STRIX SCOPE II RX

ROG STRIX SCOPE II RX

ROG STRIX SCOPE II RX

ROG STRIX SCOPE II RX

ROG STRIX SCOPE II RX

ROG STRIX SCOPE II RX

ROG STRIX SCOPE II RX

ROG STRIX SCOPE II RX

ROG STRIX SCOPE II RX

ROG STRIX SCOPE II RX

ROG STRIX SCOPE II RX

ROG STRIX SCOPE II RX

ROG STRIX SCOPE II RX

ROG STRIX SCOPE II RX

ROG STRIX SCOPE II RX

ROG STRIX SCOPE II RX

ROG STRIX SCOPE II RX

ROG STRIX SCOPE II RX

ROG STRIX SCOPE II RX

ROG STRIX SCOPE II RX

ROG STRIX SCOPE II RX

ROG STRIX SCOPE II RX

ROG STRIX SCOPE II RX

ROG STRIX SCOPE II RX

ROG STRIX SCOPE II RX

ROG STRIX SCOPE II RX

ROG STRIX SCOPE II RX

ROG STRIX SCOPE II RX

ROG STRIX SCOPE II RX

ROG STRIX SCOPE II RX

ROG STRIX SCOPE II RX

ROG STRIX SCOPE II RX

ROG STRIX SCOPE II RX

ROG STRIX SCOPE II RX

ROG STRIX SCOPE II RX

ROG STRIX SCOPE II RX

ROG STRIX SCOPE II RX

ROG STRIX SCOPE II RX

ROG STRIX SCOPE II RX

ROG STRIX SCOPE II RX

ROG STRIX SCOPE II RX

ROG STRIX SCOPE II RX

ROG STRIX SCOPE II RX

ROG STRIX SCOPE II RX

ROG STRIX SCOPE II RX

ROG STRIX SCOPE II RX

ROG STRIX SCOPE II RX

ROG STRIX SCOPE II RX

ROG STRIX SCOPE II RX

ROG STRIX SCOPE II RX

ROG STRIX SCOPE II RX

ROG STRIX SCOPE II RX

ROG STRIX SCOPE II RX

ROG STRIX SCOPE II RX

ROG STRIX SCOPE II RX

ROG STRIX SCOPE II RX

ROG STRIX SCOPE II RX

ROG STRIX SCOPE II RX

ROG STRIX SCOPE II RX

ROG STRIX SCOPE II RX

ROG STRIX SCOPE II RX

ROG STRIX SCOPE II RX

ROG STRIX SCOPE II RX

ROG STRIX SCOPE II RX

ROG STRIX SCOPE II RX

ROG STRIX SCOPE II RX

ROG STRIX SCOPE II RX

ROG STRIX SCOPE II RX

ROG STRIX SCOPE II RX

ROG STRIX SCOPE II RX

ROG STRIX SCOPE II RX

ROG STRIX SCOPE II RX

Package Contents

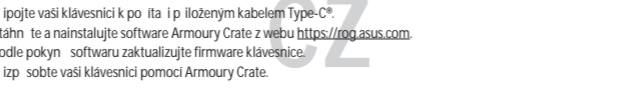
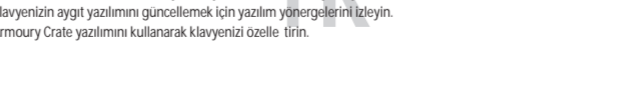
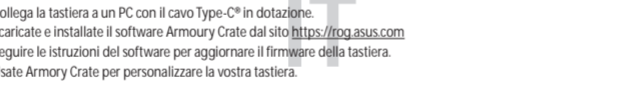
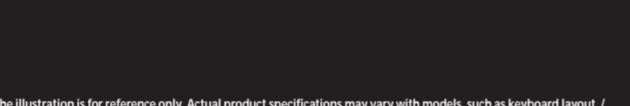

Aan de slag

- Sluit uw toetsenbord aan op een pc met de meegeleverde Type-C®-kabel.
- Download en installeer de Armoury Crate-software van <https://rog.asus.com>.
- Volg de softwareinstructies voor het bijwerken van de firmware van uw toetsenbord.
- Pas uw toetsenbord aan met Armoury Crate.

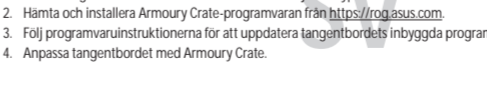
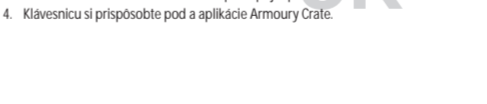
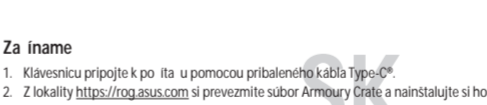
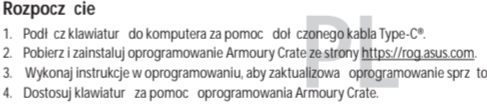
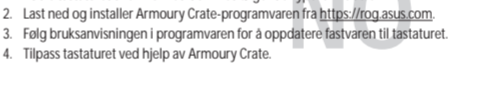
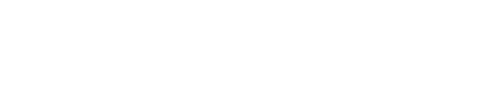
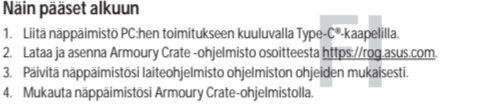
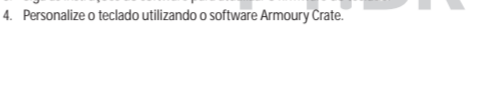
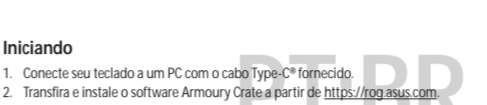

بدء

- وصّل لوحة المفاتيح بحاسوب شخصي من خلال كبل لغة C® المرفق.
- قم بتحميل برنامج Armoury Crate وتثبيته من خلال الرابط <https://rog.asus.com>.
- اتبع تعليمات البرنامج لتحديث البرنامج الثابت الخاص بلوحة المفاتيح أدناه.
- خصص لوحة المفاتيح لديك باستخدام برنامج Armoury Crate.

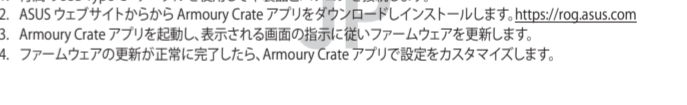
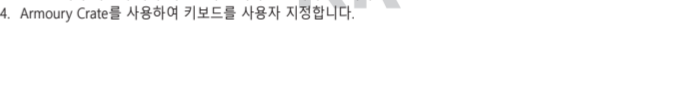
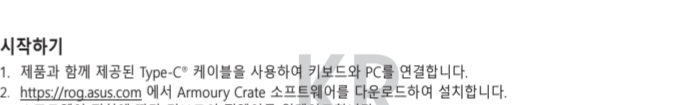
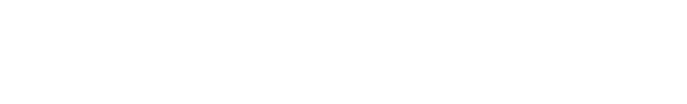
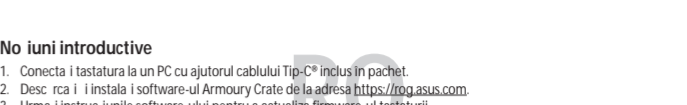

Keyboard features

Top view (US layout for reference)



Rear view

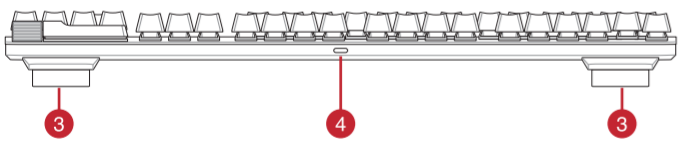

1 Switch function button / 功能切换開關 / 功能切换开关

2 Multiwheel / 滾輪 / 滚轮

3 Adjustable feet with 3 tilt positions / 三檔可調節腳墊 / 三档可调节脚垫

4 USB Type-C® port / USB Type-C® 連接埠 / USB Type-C® 接口

Getting started

- Connect your keyboard to a PC with the bundled Type-C® cable.
- Download and install the Armoury Crate software from <https://rog.asus.com>.
- Follow the software instructions to update your keyboard's firmware.
- Customize your keyboard using Armoury Crate.

Prise en main

- Connectez votre clavier à un ordinateur avec le cable Type-C® fourni.
- Téléchargez et installez le logiciel Armoury Crate en vous rendant sur <https://rog.asus.com>.
- Suivez les instructions du logiciel pour mettre à jour le firmware de votre clavier.
- Personnalisez votre clavier avec Armoury.

Erste Schritte

- Schließen Sie Ihre Tastatur mithilfe des mitgelieferten Typ-C-Kabels an einen PC an.
- Laden Sie die Armoury Crate Software unter <https://rog.asus.com> herunter und installieren Sie sie.
- Befolgen Sie die Anweisungen in der Software, um die Firmware Ihrer Tastatur zu aktualisieren.
- Passen Sie Ihre Tastatur über Armoury Crate an.

Per iniziare

- Collega la tastiera a un PC con il cavo Type-C® in dotazione.
- Scaricate e installate il software Armoury Crate dal sito <https://rog.asus.com>.
- Seguire le istruzioni del software per aggiornare il firmware della tastiera.
- Usate Armory Crate per personalizzare la vostra tastiera.

Procedimientos iniciales

- Conecte el teclado a un equipo mediante el cable Type-C® incluido.
- Descargue e instale el software Armoury Crate desde <https://rog.asus.com>.
- Siga las instrucciones de software para actualizar el firmware del teclado.
- Personalice el teclado mediante Armoury Crate.

Ba larken

- Klavyenizi birlikte verilen Type-C® kablosuyla bir bilgisayara ba layın.
- A a rdaki link üzerinden Armoury Crate yazılımını indirin ve yükleyin: [AC Link.com](https://rog.asus.com).
- Klavyenizin aygıt yazılımını güncellemek için yazılım yöneticimizi izleyin.
- Armory Crate yazılımını kullanarak klavyenizi özelle tirin.

Za ináme

- P ipojte vaši klávesnici k po ita i p iložným kabelem Type-C®.
- Stáhn te a nainstalujte software Armoury Crate z webu <https://rog.asus.com>.
- Podle pokyn softwaru zaktualizujte firmware klávesnice.
- P izp sobte vaši klávesnici pomocí Armoury Crate.

Komme i gang

- Koble tastaturet til en PC med den medfølgende Type-C®-kabelen.
- Last ned og installer Armoury Crate-programvaren fra <https://rog.asus.com>.
- Følg bruksanvisningen i programvaren for å oppdatere tastvaren til tastaturet.
- Tilpass tastaturet ved hjelp av Armoury Crate.

Rozpocz cie

- Podi cz klawiatur do komputera za pomoc dol czonego kabla Type-C®.
- Pobierz i zainstaluj oprogramowanie Armoury Crate ze strony <https://rog.asus.com>.
- Wykonaj instrukcje w oprogramowaniu, aby zaktualizowa oprogramowanie sprz towe klawiatury.
- Dostosuj klawiatur za pomoc oprogramowania Armoury Crate.

Za iname

- Klávsnicu pripojte k po ita u pomocou pribalného kábla Type-C®.
- Z lokality <https://rog.asus.com> si prevzmite súbor Armoury Crate a nainštalujte si ho.
- Pri aktualizovaní firmvéru klávesnice postupujte pod a návodu na softvér.
- Klávsnicu si prispôbte pod a aplikácie Armoury Crate.

Komma igång

- Anslut tangentbordet till en dator med den medföljande Type-C®-kabeln.
- Hämta och installera Armoury Crate-programvaran från <https://rog.asus.com>.
- Följ programvaruinstruktionerna för att uppdatera tangentbordets inbyggda programvara.
- Anpassa tangentbordet med Armoury Crate.

1. Type-C®

2. Armoury Crate <https://rog.asus.com>

3. Armoury Crate

4. Armoury Crate

1. Type-C®

2. Armoury Crate <https://rog.asus.com>

3. Armoury Crate

4. Armoury Crate

Key combinations

On-the-fly Macro Recording
Step 1: Fn + Left-ALT to start recording
Step 2: Enter the keys to be recorded as a macro
Step 3: Fn + Left-ALT to end recording
Step 4: Assign Macro Key
Profile Switch
Fn + 1 / 2 / 3 / 4 / 5 / 6*
* 6 is default
Light Effect Switch
Fn + Right or Fn + Left
Brightness Level
Fn + Up: Brightness up
Fn + Down: Brightness down
Factory Default
Fn + Esc: Hold these two buttons until the LEDs blink green.
Windows lock
Fn + Windows key: Lock Windows key
F-Switch
Fn + INS: Toggle between function keys or F1-F12 (default)
Function keys:
F1: (Win + G) Open the Game Bar
F2: (Win + Alt + PrintScreen) Take a screenshot of your game
F3: (Win + Alt + G) Record the last 30 seconds
F4: (Win + Alt + R) Start or stop recording
F5: (Win + Alt + M) Start or stop microphone recording
F6: Play/Pause
F7: Previous track
F8: Next track
F9: Mute
F10: Volume up
F11: Volume up
F12: Stealth key

Multiwheel and Switch function button

Press the Switch function button **(A)** to rotate between modes. You can then use the Multiwheel to adjust the settings for each function **(B, C, D)**.

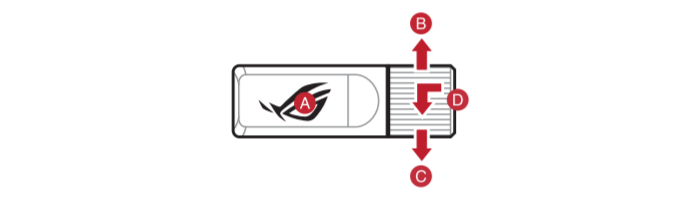

Modes	
Media Control	B : Volume up C : Volume down D : Mute/Unmute
Media Content	B : Previous track C : Next track D : Play/Pause
Brightness adjustment	B : Brightness up C : Brightness down D : Brightness 100% / brightness 0%
Customization (Reassignment in Armoury Crate)	B : Scroll up (default, can be reassigned) C : Scroll down (default, can be reassigned) D : Scroll click (default, can be reassigned)

Swapping the Spacebar

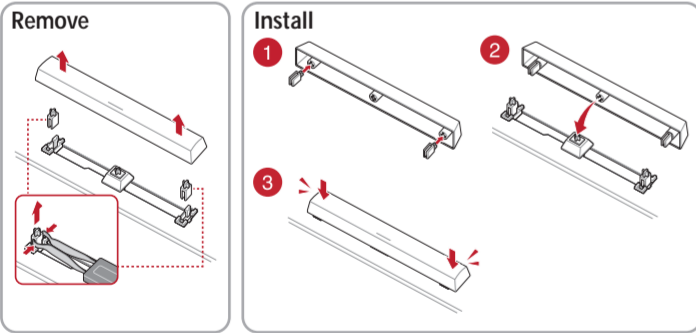

Safety Guidelines

Keep the device away from liquid, humidity, or moisture. Operate the device only within the specific temperature range of 0°C(32°F) to 40°C(104°F). When the device exceeds the maximum temperature, unplug or switch off the device to let it cool down.

付属品は当該専用品です。他の機器には使用しないでください。機器の破損もしくは、火災や感電の原因となることがあります。

安全說明

- 此滑鼠只應在溫度不高於 40°C（104°F）的環境下使用。
- 安裝錯誤型號的電池可能會導致爆炸。

Notices

Limitation of Liability

Circumstances may arise where because of a default on ASUS part or other liability, you are entitled to recover damages from ASUS. In each such instance, regardless of the basis on which you are entitled to claim damages from ASUS, ASUS is liable for no more than damages for bodily injury (including death) and damage to real property and tangible personal property, or any other actual and direct damages resulted from omission or failure of performing legal duties under this Warranty Statement, up to the listed contract price of each product.

ASUS will only be responsible for or indemnify you for loss, damages or claims based in contract, tort or infringement under this Warranty Statement.

This limit also applies to ASUS suppliers and its reseller. It is the maximum for which ASUS, its suppliers, and your reseller are collectively responsible.

UNDER NO CIRCUMSTANCES IS ASUS LIABLE FOR ANY OF THE FOLLOWING: (1) THIRD-PARTY CLAIMS AGAINST YOU FOR DAMAGES; (2) LOSS OF, OR DAMAGE TO, YOUR RECORDS OR DATA; OR (3) SPECIAL, INCIDENTAL, OR INDIRECT DAMAGES OR FOR ANY ECONOMIC CONSEQUENTIAL DAMAGES (INCLUDING LOST PROFITS OR SAVINGS), EVEN IF ASUS, ITS SUPPLIERS OR YOUR RESELLER IS INFORMED OF THEIR POSSIBILITY.

Federal Communications Commission Statement

This device complies with Part 15 of the FCC Rules. Operation is subject to the following two conditions:

- This device may not cause harmful interference.
- This device must accept any interference received including interference that may cause undesired operation.

This equipment has been tested and found to comply with the limits for a Class B digital device, pursuant to Part 15 of the FCC Rules. These limits are designed to provide reasonable protection against harmful interference in a residential installation. This equipment generates, uses and can radiate radio frequency energy and, if not installed and used in accordance with manufacturer's instructions, may cause harmful interference to radio communications. However, there is no guarantee that interference will not occur in a particular installation. If this equipment does cause harmful interference to radio or television reception, which can be determined by turning the equipment off and on, the user is encouraged to try to correct the interference by one or more of the following measures:

- Reorient or relocate the receiving antenna.
- Increase the separation between the equipment and receiver.
- Connect the equipment to an outlet on a circuit different from that to which the receiver is connected.
- Consult the dealer or an experienced radio/TV technician for help.

CAUTION! The use of shielded cables for connection of the monitor to the graphics card is required to assure compliance with FCC regulations. Changes or modifications to this unit not expressly approved by the party responsible for compliance could void the user's authority to operate this equipment.
--

Compliance Statement of Innovation, Science and Economic Development Canada (ISED)

This device complies with Innovation, Science and Economic Development Canada licence exempt RSS standard(s). Operation is subject to the following two conditions: (1) this device may not cause interference, and (2) this device must accept any interference, including interference that may cause undesired operation of the device.

CAN ICES-003(B)/NMB-003(B)

Déclaration de conformité de Innovation, Sciences et Développement économique Canada (ISED)

Le présent appareil est conforme aux CNR d'Innovation, Sciences et Développement économique Canada applicables aux appareils radio exempts de licence. L'exploitation est autorisée aux deux conditions suivantes : (1) l'appareil ne doit pas produire de brouillage, et (2) l'utilisateur de l'appareil doit accepter tout brouillage radioélectrique subi, même si le brouillage est susceptible den compromettre le fonctionnement.

CAN ICES-003(B)/NMB-003(B)

ASUS Recycling/Takeback Services

ASUS recycling and takeback programs come from our commitment to the highest standards for protecting our environment. We believe in providing solutions for you to be able to responsibly recycle our products, batteries, other components as well as the packaging materials. Please go to <http://csr.asus.com/english/Takeback.htm> for detailed recycling information in different regions.

REACH

Complying with the REACH (Registration, Evaluation, Authorisation and Restriction of Chemicals) regulatory framework, we published the chemical substances in our products at ASUS REACH website at <http://csr.asus.com/english/REACH.htm>.

Proper disposal

 DO NOT throw the device in municipal waste. This product has been designed to enable proper reuse of parts and recycling. The symbol of the crossed out wheeled bin indicates that the product (electrical, electronic equipment and mercury-containing button cell battery) should not be placed in municipal waste. Check local regulations for disposal of electronic products.

 DO NOT throw the device in fire. DO NOT short circuit the contacts. DO NOT disassemble the device.

 电子电气产品有害物质限制使用标识：图中之数字为产品之环保使用期限。仅指电子电气产品中含有的有害物质不致发生外泄或突变，从而对环境造成污染或对人身、财产造成严重损害的期限。

部件名称	有害物质					
	铅 (Pb)	汞 (Hg)	镉 (Cd)	六价铬 (Cr (VI))	多溴联苯 (PBB)	多溴二苯醚 (PBDE)
印刷电路板及其电子组件	×	○	○	○	○	○
外壳	○	○	○	○	○	○
外部信号连接头及线材	○	○	○	○	○	○
其它	×	○	○	○	○	○

本表格依据 SJ/T 11364 的规定编制。

○：表示该有害物质在该部件所有均质材料中的含量均在 GB/T 26572 规定的限量要求以下。

×：表示该有害物质至少在该部件的某一均质材料中的含量超出 GB/T 26572 规定的限量要求，然该部件仍符合欧盟指令 2011/65/EU 的规范。

备注：此产品所标示之环保使用期限，系指在一般正常使用状况下。

「產品之限用物質含有情況」之相關資訊，請參考下表：

單元	限用物質及其化學符號					
	鉛 (Pb)	汞 (Hg)	鎘 (Cd)	六價鉻 (Cr ⁶⁺)	多溴聯苯 (PBB)	多溴二苯醚 (PBDE)
印刷電路板及電子組件	—	○	○	○	○	○
外壳	○	○	○	○	○	○
按鍵	○	○	○	○	○	○
其他及其配件	○	○	○	○	○	○

備考1. “○” 係指該項限用物質之百分比含量未超出百分比含量基準值。

備考2. “—” 係指該項限用物質為排除項目。

VCCI: Japan Compliance Statement

VCCI Class B Statement

警告 VCCI準拠クラスB機器 (日本)

この装置は、情報処理装置等電波障害自主規制協議会 (VCCI) の基準に基づくクラス B 情報技術装置です。この装置は、家庭環境で使用することを目的としていますが、この装置がラジオやテレビジョン受信機に近接して使用されると、受信障害を引き起こすことがあります。

取扱説明書に従って正しい取り扱いをして下さい。

KC: Korea Warning Statement

본급 기기 (가정용 방송통신기자재) 의 기기는 가정용(가정) 전자파 적합기기로서, 주로 가정에서 사용하는 것을 목적으로 하며, 모든 지역에서 사용할 수 있습니다.

R-R-MSQ-XA12

Regional notice for Singapore

Complies with IMDA Standards DB103778	This ASUS product complies with IMDA Standards.
---------------------------------------	---

France sorting and recycling information



Ukraine Certification Logo



EAC Certification Logo



Simplified UKCA Declaration of Conformity

ASUSTek Computer Inc. hereby declares that this device is in compliance with the essential requirements and other relevant provisions of The Radio Equipment Regulations 2017 (S.I. 2017/1206). Full text of UKCA declaration of conformity is available at <https://www.asus.com/support/>.

CE Mark Warning



English ASUSTek Computer Inc. hereby declares that this device is in compliance with the essential requirements and other relevant provisions of related Directives. Full text of EU declaration of conformity is available at: www.asus.com/support
Français ASUSTek Computer Inc. déclare par la présente que cet appareil est conforme aux critères essentiels et autres clauses pertinentes des directives concernées. La déclaration de conformité de l'UE peut être téléchargée à partir du site Internet suivant : www.asus.com/support
Deutsch ASUSTek Computer Inc. erklärt hiermit, dass dieses Gerät mit den wesentlichen Anforderungen und anderen relevanten Bestimmungen der zugehörigen Richtlinien übereinstimmt. Der gesamte Text der EU-Konformitätserklärung ist verfügbar unter: www.asus.com/support
Italiano ASUSTek Computer Inc. con la presente dichiara che questo dispositivo è conforme ai requisiti essenziali e alle altre disposizioni pertinenti con le direttive correlate. Il testo completo della dichiarazione di conformità UE è disponibile all'indirizzo: www.asus.com/support

Русский Компания ASUS заявляет, что это устройство соответствует основным требованиям и другим соответствующим условиям соответствующих директив. Подробную информацию, пожалуйста, смотрите на www.asus.com/support

Български С настоящото ASUSTek Computer Inc. декларира, че това устройство е в съответствие със съществениите изисквания и другите приложими постановления на свързаните директиви. Пълният текст на декларацията за съответствие на ЕС е достъпен на адрес: www.asus.com/support

Hrvatski ASUSTek Computer Inc. ovim izjavljuje da je ovaj ure a) sukladan s bitnim zahtjevima i ostalim odgovaraju im odredbama vezanih direktiva. Cijeli tekst EU izjave o sukladnosti dostupan je na: www.asus.com/support

eština Spole nost ASUSTek Computer Inc. tímto prohlašuje, že toto za izeni spl uje základní požadavky a další p íslušná ustanovení souvisejících sm rnic. Plné zn ní prohlášení o shod EU je k dispozici na adrese: www.asus.com/support
Dansk ASUSTek Computer Inc. erklærer hermed, at denne enhed er i overensstemmelse med hovedkravene og andre relevante bestemmelser i de relaterede direktiver. Hele EU-overensstemmelseserklæringen kan findes på: www.asus.com/support

Nederlands ASUSTek Computer Inc. verklaart hierbij dat dit apparaat voldoet aan de essentiële vereisten en andere relevante bepalingen van de verwante richtlijnen. De volledige tekst van de EU-verklaring van conformiteit is beschikbaar op: www.asus.com/support

Eesti Käesolevaga kinnitab ASUSTek Computer Inc. et see seade vastab asjakohaste direktiivide oluliste nõuetele ja teiste asjassepuutuvatele sätetele. EL vastavusdeklaratsiooni täielik tekst on saadaval järgmisel aadressil: www.asus.com/support

Suomi ASUSTek Computer Inc. ilmoittaa täten, että tämä laite on asiaankuuluvien direktiivien olennaisten vaatimusten ja muiden lätä koskevien säädösten mukainen. EU-yhdenmukaisuusilmoituksen koko teksti on luettavissa osoitteessa: www.asus.com/support

Magyar ASUSTek Computer Inc. kijelenti, hogy ez az eszköz megfelel a kapcsolódó irányelvek lényeges követelményeinek és egyéb vonatkozó rendelkezéseinek. Az EU megfelel ségi nyilatkozat teljes szövege innen letölthető : www.asus.com/support

Latviski ASUSTek Computer Inc. ar šo pazi ņo, ka š ier ce atbilst saist to Direktīvu b tiskaj m pras b m un citiem citiem saistotajiem nosac ģumiem. Pilns ES atbilst bas pazi ņuma teksts pieejams šeit: www.asus.com/support
Lietuvi ASUSTek Computer Inc. šiuo tvirtina, kad šis renginys atitinka pagrindinius reikalavimus ir kitas svarbias susijusi direktyv nuostatas. Vis ES atitikties deklaracijos tekst galima rasti: www.asus.com/support

Norsk ASUSTek Computer Inc. erklærer herved at denne enheten er i samsvar med hovedsaklige krav og andre relevante forskrifter i relaterte direktiver. Fullstendig tekst for EU-samsvarserklæringen finnes på: www.asus.com/support
Polski Firma ASUSTek Computer Inc. niniejszym o wiadcza, e uznie to jest zgodne z zasadniczymi wymogami i innymi wia cwiymi postanowieniami powi zanych dyrektyw. Pełny tekst deklaracji zgodno ci UE jest dost pny pod adresem: www.asus.com/support

Português A ASUSTek Computer Inc. declara que este dispositivo está em conformidade com os requisitos essenciais e outras disposições relevantes das Diretivas relacionadas. Texto integral da declaração da UE disponível em: www.asus.com/support
Român ASUSTek Computer Inc. declar c acest dispozitiv se conformeaz erin elor esen iale i altor prevederi relevante ale directivelor conexe. Textul complet al declara iei de conformitate a Uniunii Europene se g se te la: www.asus.com/support

Srpski ASUSTEK Computer Inc. ovim izjavljuje da je ovaj ure aj u saglasnosti sa osnovnim zahtevima i drugim relevantnim odredbama povezanih Direktiva. Pun tekst EU deklaracije o usaglasnosti je dostupan da adresi: www.asus.com/support

Slovensky Spolo nos ASUSTek Computer Inc. týmto vyhlasuje, že toto zariadenie vyhovuje základným požiadavkám a ostatým príslušným ustanoveniam príslušných smerníc. Celý text vyhlásenia o zhode pre štáty EU je dostupný na adrese: www.asus.com/support
Slovens ina ASUSTek Computer Inc. izjavlja, da je ta naprava skladna z bistvenimi zahtevami in drugimi ustreznimi dolo bami povezanih direktiv. Celotno besedilo EU-izjave o skladnosti je na voljo na spletnem mestu: www.asus.com/support

Español Por la presente, ASUSTek Computer Inc. declara que este dispositivo cumple los requisitos básicos y otras disposiciones pertinentes de las directivas relacionadas. El texto completo de la declaración de la UE de conformidad está disponible en: www.asus.com/support

Svenska ASUSTek Computer Inc. förklarar härmed att denna enhet överensstämmer med de grundläggande kraven och andra relevanta föreskrifter i relaterade direktiv. Fulltext av EU-försäkran om överensstämmelse finns på: www.asus.com/support
Українська ASUSTek Computer Inc. заявляє, що цей пристрій відповідає основним вимогам та іншим відповідним положенням відповідних Директив. Повний текст декларації відповідності стандартам ЄС доступний на: www.asus.com/support

Türkçe ASUSTek Computer Inc. bu aygıtın temel gereksinimlerle ve ili Yönetgelerin di er ilgili kullarıyla uyumlu oldu unu beyan eder. AB uygunluk bildiriminin tam metni u adreste bulunabilir: www.asus.com/support

Bosanski ASUSTEK Computer Inc. ovim izjavljuje da je ovaj ure aj uskla en sa bitnim zahtjevima i ostalim odgovaraju im odredbama vezanih direktiva. Cijeli tekst EU izjave o uskla enosti dostupan je na: www.asus.com/support

עברית ASUSTek Computer Inc. מצהיר כאן כי המכשיר הזה תואם לדרושים החיוניים ולשאר הטיפוסים של תקנה. ניתן לקרוא את הנוסח המלא של הערות התאמת הרגולטורית עבור האיחוד האירופי בכתובת: www.asus.com/support

Service and Support

Visit our multi-language website at <https://www.asus.com/support/>.



ASUSTek Computer Inc. : www.asus.com/support : +7(495)231-1999 : 8-800-100-2787	ASUS : www.asus.ru : www.asus.com/ru/support
ASUSTek COMPUTER INC. 1F, No. 15, Lide Rd., Beitou Dist., Taipei City 112	ASUS COMPUTER GmbH
Europe Address	Harkortstrasse 21-23, 40880 Ratingen
Country	Germany
Authorized Representative in United Kingdom	ASUSTEK (UK) LIMITED
Address	1st Floor, Sackville House, 143-149 Fenchurch Street, London, EC3M 6BL, England
Country	United Kingdom