

Lenovo Legion R25f-30 User Guide

Lenovo

Product numbers

G23245FR1

67B8-GACB-WW

67B8-GASB-CB

First Edition (March 2023)

© Copyright Lenovo 2023.

LENOVO products, data, computer software, and services have been developed exclusively at private expense and are sold to governmental entities as commercial items as defined by 48 C.F.R. 2.101 with limited and restricted rights to use, reproduction and disclosure.

LIMITED AND RESTRICTED RIGHTS NOTICE: If products, data, computer software, or services are delivered pursuant a General Services Administration "GSA" contract, use, reproduction, or disclosure is subject to restrictions set forth in Contract No. GS-35F-05925.

Contents

Safety information	iv
General Safety guidelines	iv
Chapter 1. Getting started	1-1
Shipping contents	1-1
Notice for use.....	1-1
Product overview.....	1-2
Setting up your monitor	1-4
Chapter 2. Adjusting and using your monitor	2-1
Comfort and accessibility	2-1
Arranging your work area	2-1
Positioning and viewing your monitor	2-1
Quick tips for healthy work habits	2-2
Adjusting your monitor image.....	2-3
Selecting a supported display mode	2-7
Understanding power management.....	2-7
Caring for your monitor	2-8
Detaching the monitor base and stand	2-8
Wall Mounting (Optional)	2-9
Chapter 3. Reference information	3-1
Monitor specifications.....	3-1
Troubleshooting.....	3-3
Manually installing the monitor driver.....	3-5

Appendix A. Service and Support.....	A-1
Registering your option	A-1
Online technical support.....	A-1
Telephone technical support	A-1
Appendix B. Notices.....	B-1
Recycling information	B-2
Trademarks.....	B-3
Power cords and power adapters	B-3

Safety information

General Safety guidelines

For tips to help you use your computer safely, go to:
<http://www.lenovo.com/safety>

Before installing this product, read the Safety Information.



DANGER

To avoid shock hazard:

- Do not remove the covers.
- Do not operate this product unless the stand is attached.
- Do not connect or disconnect this product during an electrical storm.
- The power cord plug must be connected to a properly wired and grounded power outlet.
- Any equipment to which this product will be attached must also be connected to properly wired and grounded power outlets.
- To isolate the monitor from the electrical supply, you must remove the plug from the power outlet. The power outlet should be easily accessible.

To take special precautions to avoid the introduction of hazards when operating, installing, servicing, transporting or storing equipment, the necessary instructions shall be made available.

To reduce the risk of electric shock, do not perform any servicing other than that contained in the operating instructions unless you are qualified to do so.

AC/DC Power supply with LED backlight driving circuits for used in LCD monitor.

For building in Class I equipment by skilled persons.

Protection against electric shock, fire hazards shall be provided in final product.

Handling:

- If your monitor weighs more than 18 kg (39.68 lb), it is recommended that it be moved or lifted by two people.

Make sure the light bar is located downside when using VESA mount setup.

Chapter 1. Getting started

This User's Guide provides detailed operation instructions for the user. For quick instruction overview, please see the Setup Poster for brief information.

R25f-30 supports Lenovo Accessories and Display Manager* - **Artery**.

*Formerly Lenovo Display Control Center.

Shipping contents

The product package should include the following items:

- Information Flyer
- Lenovo Limited Warranty Booklet
- Flat Panel Monitor
- Power Cord
- DP 1.4 Cable
- Base
- Stand

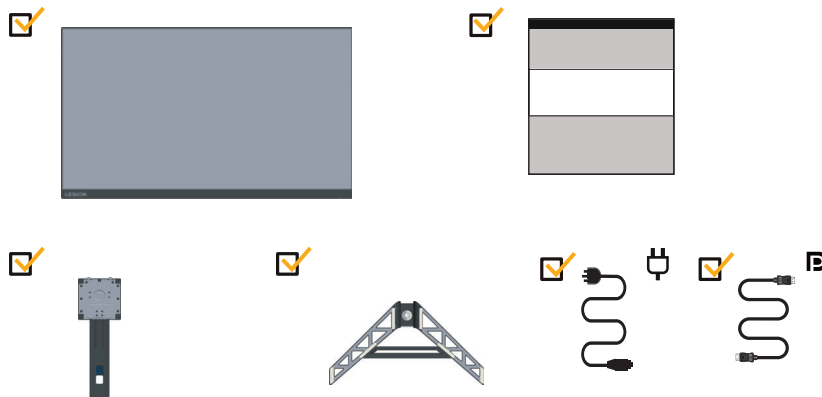

Notice for use

To set up your monitor, please see the illustrations below.

Note: Do not touch the monitor within the screen area. The screen area is glass and can be damaged by rough handling or excessive pressure.



1. Place your monitor with the screen face down on a soft flat surface.

2. Insert the base towards the stand until it locks in place.

3. Align the stand assembly bracket to the monitor.

Note: To install a VESA mount, please see "Wall Mounting (Optional)" on page 2-9.

Don't press hard screen (screen arch up).

Product overview

This section will provide information on adjusting monitor positions, setting user controls, and using the cable lock slot.

Types of adjustments

Tilt

Please see the illustration below for an example of the tilt range.

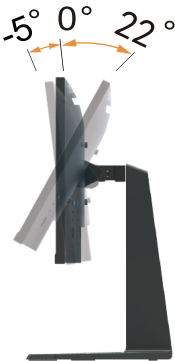

Swivel

With the built-in pedestal, you can tilt and swivel the monitor for the most comfortable viewing angle.



Height Adjustment

For height adjustment, user needs to press down or lift up the monitor.



Monitor Pivot

- Adjust the screen position before rotating the monitor screen. (Make sure that the monitor screen ascent to its highest point, and it inclines backward at 22°.)
- then rotate clockwise until the monitor stops at 90°

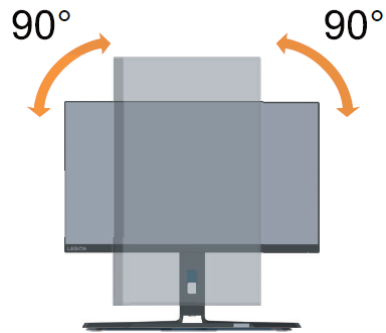

Monitor controls

The keypad controls on the back cover are accesses to various functions.



For information on how to utilize these keypad controls, please see “Adjusting your monitor image” on page 2-3.

Cable lock slot

Your monitor is equipped with a cable lock slot located under the rear of your monitor.



Setting up your monitor

This section provides information on how to set up your monitor.

Connecting and turning on your monitor

Note: Be sure to read the Safety information on page iv before carrying out this procedure.

1. Power off your computer and all attached devices, and unplug the computer power cord.



2. Connect the cables according to below icon indication.

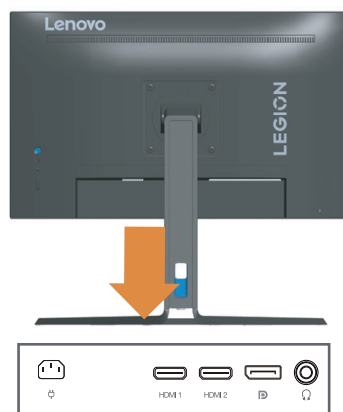

-
3. Connect one end of the DP cable to the DP connector on the back of the computer, and the other end to the DP connector on the monitor. Lenovo recommends that customers who require to use the Display Port input on their monitor purchase the "Lenovo Display Port to Display Port cable 0A36537".
www.lenovo.com/support/monitoraccessories

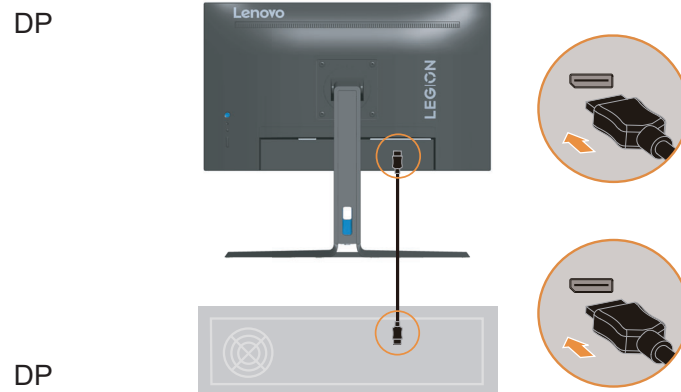

4. Connect one end of the HDMI cable to the HDMI connector on the back of the computer, and the other end to the HDMI connector on the monitor. Lenovo recommends that customers who require to use the HDMI input on their monitor purchase the "Lenovo HDMI to HDMI cable OB47070"
(www.lenovo.com/support/monitoraccessories)

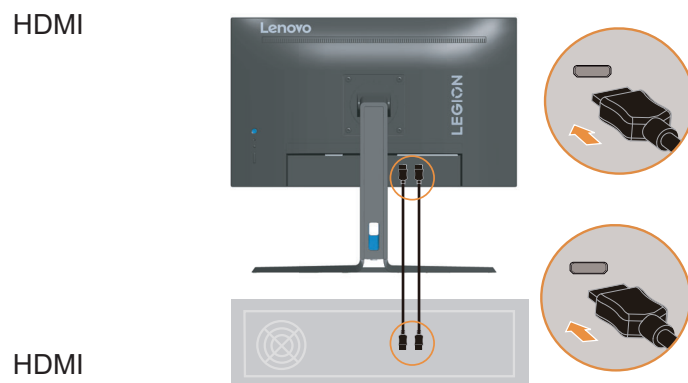

-
5. Connect the speaker's audio cable and audio jack of monitor to transfer audio source from Display Port, or HDMI.

Note: The audio output in HDMI/DP modes.

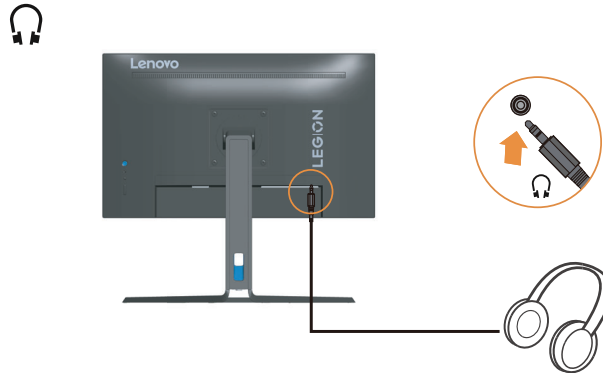

6. Plug the monitor power cord and the computer cord into grounded electrical outlets.
Note: A certified power supply cord has to be used with this equipment. The relevant national installation and or equipment regulations shall be considered. A certified power supply cord not lighter than ordinary polyvinyl chloride flexible cord according to IEC 60227 (designation H05VV-F 3G 0.75mm² or H05VVH2-F2 3G0.75mm²) shall be used. Alternative a flexible cord be of synthetic rubber according to IEC 60245 (designation H05RR-F 3G 0.75mm²) shall be used.

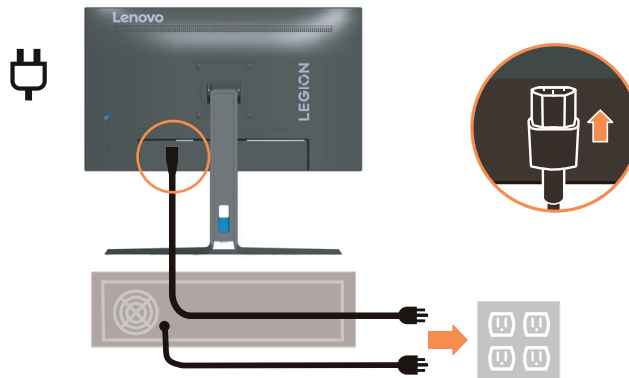

7. Connect the cables with cable clip.

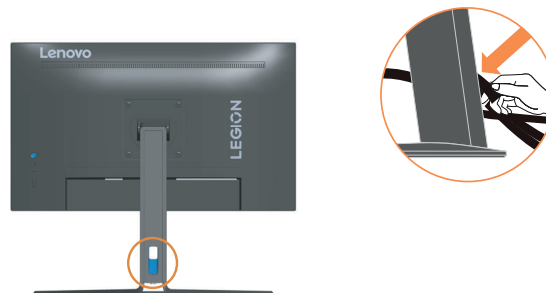

8. Power on the monitor and the computer.

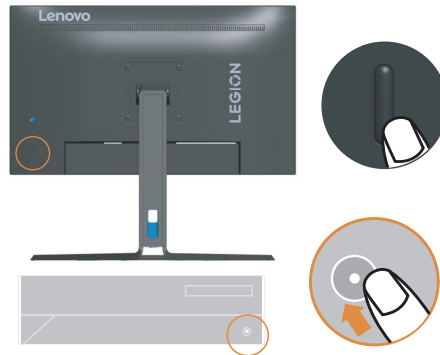

9. When you install the monitor driver, download the driver that corresponds to your monitor model from the Lenovo website http://pcsupport.lenovo.com/solutions/R25f_30. Refer to the "Manually installing the monitor driver" on page 3-5 section to install the driver.



Chapter 2. Adjusting and using your monitor

This section will give you information on adjusting and using your monitor.

Comfort and accessibility

Good ergonomic practice is important to get the most from your personal computer and to avoid discomfort. Arrange your workplace and the equipment you use to suit your individual needs and the kind of work that you perform. In addition, use healthy work habits to maximize your performance and comfort while using your computer. For more detailed information on any of these topics, visit the Healthy Computing Web site at: <http://www.lenovo.com/healthycomputing/>.

Arranging your work area

Use a work surface of appropriate height and available working area to allow you to work in comfort.

Organize your work area to match the way you use materials and equipment. Keep your work area clean and clear for the materials that you typically use and place the items that you use most frequently, such as the computer mouse or telephone, within the easiest reach. Equipment layout and setup play a large role in your working posture. The following topics describe how to optimize equipment setup to achieve and maintain good working posture.

Positioning and viewing your monitor

Position and adjust your computer monitor for comfortable viewing by considering the following items:

- **Viewing distance:** Recommended viewing distance between the eye and the monitor screen is 1.5 x the diagonal of the screen. Solutions in meeting this required distance in cramped office situations include pulling desk away from wall or divider to make room for monitor, using flat panel or compact displays placing the monitor in the desk corner, or placing the keyboard in an adjustable drawer to create a deeper working surface.
- **Monitor height:** Position the monitor so your head and neck are in a comfortable and neutral (vertical, or upright) position. If your monitor does not have height adjustments, you might have to place books or other sturdy objects under the base of the monitor to achieve the desired height. A general guideline is to position the monitor such that the top of the screen is at or slightly below your eye-height when you are comfortably seated. However, be sure to optimize your monitor height so the line of site between your eyes and the center the monitor suits your preferences for visual distance and comfortable viewing when your eye muscles are in a relaxed state.
- **Tilt:** Adjust the tilt of your monitor to optimize the appearance of the screen content and to accommodate your preferred head and neck posture.
- **General location:** Position your monitor to avoid glare or reflections on the screen from overhead lighting or nearby windows.

The following are some other tips for comfortable viewing of your monitor:

- Use adequate lighting for the type of work you are performing.
- Use the monitor brightness, contrast, and image adjustment controls, if equipped, to optimize the image on your screen to meet your visual preferences.
- Keep your monitor screen clean so you can focus on the screen's contents.

Any concentrated and sustained visual activity can be tiring for your eyes. Be sure to periodically look away from your monitor screen and focus on a far object to allow your eye muscles to relax. If you have questions on eye fatigue or visual discomfort, consult a vision care specialist for advice.

Quick tips for healthy work habits

The following information is a summary of some important factors to consider to help you remain comfortable and productive while you use your computer.









- **Good posture starts with equipment setup:** The layout of your work area and the setup of your computer equipment have a large effect on your posture while using your computer. Be sure to optimize the position and orientation of your equipment by following the tips outlined in “Arranging your work area ” on page 2-1 so you can maintain a comfortable and productive posture. Also, be sure to use the adjustment capabilities of your computer components and office furniture to best suit your preferences now and as your preferences change over time.
- **Minor changes in posture can help avoid discomfort:** The longer you sit and work in front of your computer, the more important it is to observe your working posture. Avoid assuming any one posture for an extended period of time. Periodically make minor modifications in your posture to help deter any discomforts that might arise. Make use of any adjustments that your office furniture or equipment provide to accommodate changes in posture
- **Short, periodic breaks help ensure healthy computing:** Because computing is primarily a static activity, it is particularly important to take short breaks from your work. Periodically, stand up in front of your work area, stretch, walk for a drink of water, or otherwise take a short break from using your computer. A short break from work gives your body a welcome change in posture and helps to ensure you remain comfortable and productive while you do work.

Adjusting your monitor image

This section describes the user control features used to adjust your monitor image.

Using the direct access controls

The direct access controls can be used when the On Screen Display (OSD) is not displayed.

	Icon	Control	Description
1		Power (Under any situation)	DC Off / On
2		Menu (No menu on the screen)	Opens the main menu
		Enter (Main menu)	Enters the next menu OK
		Increase (Main menu)	Increases the value
		Volume (No menu on the screen)	Quickly enters the Volume adjustment page
		Volume Up (Volume page in the main menu)	Increases the volume (and releases Mute state)
		Decrease (Main menu)	Decreases the value
		Volume (No menu on the screen)	Quickly enters the Volume adjustment page
		Volume Down (Volume page in the main menu)	Decreases the volume (and releases Mute state)
		Back Exit (Main menu)	Returns to the previous menu Exits the menu
		Up (Main menu)	Moves the cursor up
		Brightness (No menu on the screen)	Quickly enters the Brightness adjustment page
		Down (Main menu)	Moves the cursor down
		Brightness (No menu on the screen)	Quickly enters the Brightness adjustment page
	3		Game Mode (No menu on the screen)
4		Input Source (No menu on the screen)	Quickly enters the Input Source adjustment page
		OSD locked/un-locked	Press and hold for 10 seconds ,then Main menu will be Locked/un-Locked.

Using the On-Screen Display(OSD) controls

To adjust the settings, the user controls can be viewed through the OSD.

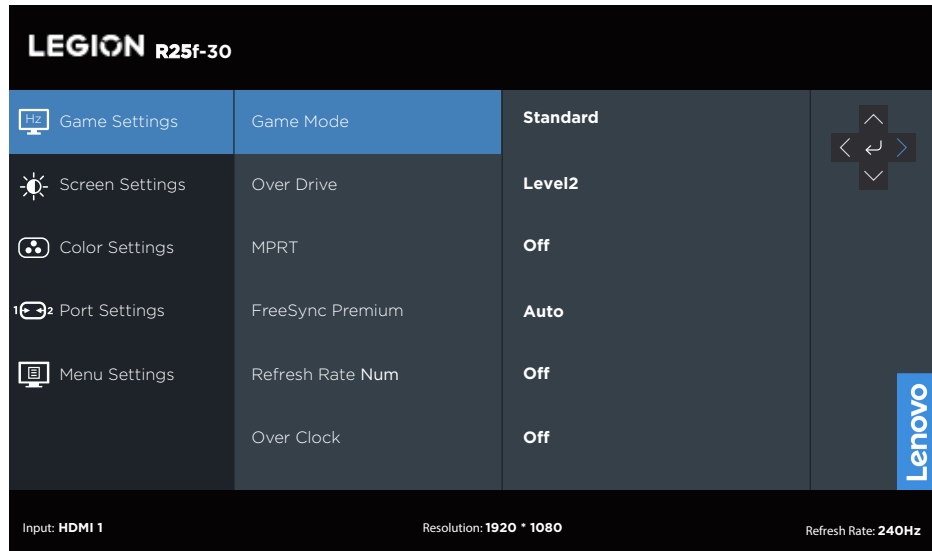

To use the controls:

















1. Press  to open the main OSD menu.
2. Use  or  to move among the icons. Select an icon and press  to access that function. If there is a sub-menu, you can move between options using  or , then press  to select that function. Use  or  to make adjustments then press  to save.
3. Press  to move backwards through the sub-menus and exit from the OSD.

Table 2-1. OSD functions

OSD Icon on Main Menu	Sub menu	Description	Controls and Adjustments
 Game Settings	Game Mode	[Standard]	All input ports
		Standard	
		FPS1	
		FPS2	
		Racing	
		RTS	
		Game1:[brightness/Over Drive/contrast/Relative Gamma]	
	Game2:[brightness/Over Drive/contrast/Relative Gamma]		
	Over Drive	[Level2]	
		Off	
		Level1	
Level2			
Level3			
MPRT	[Off] On/Off		
FreeSync Premium	[Auto] Off/Auto	Only HDMI port	
AdaptiveSync	[Auto (AMD FreeSync Premium)] Auto (AMD FreeSync Premium)/Off	Only DP port	
Refresh Rate Num	[Off] Off/Left Top/Right Top/ Left Bottom/Right Bottom		
Over Clock	[Off] Off /On	Only DP port	
 Screen Settings	Brightness	[75] 0~100	All input ports
	Contrast	[75] 0~100	
	DCR	[Off]] On/Off	
	HDR	[Auto] Auto/HDR Off	
	Dark Boost	[Level4] Level1/Level2/Level3/Level4	
	Scaling Mode	[Full Screen] Original AR/Full Screen	
	Sharpness	[40] 0~100	
	Relative Gamma	[Default] -0.4/-0.2/Default/+0.2/+0.4/Off	
	Video Range	[Full Range 0-255] Auto/Full Range 0-255/Limited Range 16-235	
 Color Settings	Color Temp.	[Warm]	
		DCI-P3	
		sRGB	
		Warm	
		Neutral	
		Cool	
		User(Select this option to enter the next page)	
	Saturation	[50]0~100	

OSD Icon on Main Menu	Sub menu	Description	Controls and Adjustments
 Port Settings	Input Signal	[Auto Switch Input]	All input ports
		Auto Switch Input	
		DP	
		HDMI1	
 Menu Settings	DP Select	[DP1.4] DP1.2 / DP1.4	Only DP port
	Mirrored Power Button	HDMI:[Off] On/Off	Only HDMI port
 Menu Settings	Information	Model	All input ports
		Firmware	
		Serial Number	
		HDR	
		Mode	
		Format	
	Language	English	
		French (Français)	
		Italian (Italiano)	
		Simplified Chinese (简体中文)	
		Spanish (Español)	
		Japanese (日本語)	
		German (Deutsch)	
		Russian (Русский)	
		Ukraine (Українська)	
	Thai (ไทย)		
	Volume	[50] 0~100	
	Button Repeat Rate	[Default]Default/Slow/Off	
	LED Indicator	[On] On/Off	
	OSD Timeout	[10] 5~60(1 seconds per unit)	
Menu Position	[0] 0~100		
Transparency	[0]		
	0		
	20		
	40		
	60		
	80		
100			
DDC/CI	[On] On/Off		
Reset All Settings	Reset monitor to the original settings.		

*The use of Level 4 (Over Drive) may result in reduced display quality when fast moving video graphics are displayed.
Users should check Level 4 (Over Drive) to verify if it is compatible with any applications they would like to use it with.

*Enable the display HDR function requires that the connected PC system supports the HDR function.

*Adaptive sync and 280Hz overclocking are test results obtained in a laboratory environment. The actual performance may vary depending on the user's environment.

*The overclocking function will automatically be disabled after 30 minutes. Prolonged use of the overclocking function may result in abnormal screen display or other adverse effects.
Lenovo recommends a direct connection for this function. Please do not use an adapter cable or adapter.

Selecting a supported display mode

The display mode the monitor uses is controlled by the computer. Therefore, refer to your computer documentation for details on how to change display modes.

The image size, position and shape might change when the display mode changes. This is normal and the image can be re-adjusted using automatic image setup and the image controls.

Unlike CRT monitors, which require a high refresh rate to minimize flicker, LCD or Flat Panel technology is inherently flicker-free.

Note: If your system has previously been used with a CRT monitor and is currently configured to a display mode outside the range of this monitor, you may need to reattach the CRT monitor temporarily until you have re-configured the system; preferably to 1920x1080 at 240Hz, which is a common display mode.

The display modes shown below have been optimized at the factory.

Table 2-2. Factory set display modes

Support Timing table	
640x480	60Hz, 72Hz,75Hz
720x400	70Hz
800x600	56Hz,60Hz,72Hz,75Hz
832x624	75Hz
1024x768	60Hz,70Hz,75Hz
1152x864	75Hz
1280x1024	60Hz,70Hz,75Hz
1440x900	60Hz
1680x1050	60Hz,70Hz(DP only)
1600x900	60Hz,75Hz
1920x1080	60Hz,100Hz,120Hz,144Hz,165 Hz 240Hz,280Hz(Over Clock DP only)

Understanding power management

Power management is invoked when the computer recognizes that you have not using your mouse or keyboard for a user-definable period. There are several states as described in the table below.

For optimal performance, switch off your monitor at the end of each working day, or whenever you expect to leave it unused for long periods during the day.

Table 2-3. Power indicator

State	Power Indicator	Screen	Restoring Operation
On	White	Normal	
Standby/Suspend	Amber	Blank	Press a key or move the mouse. There may be a slight delay reappears. Note: Standby also occurs if there is no image output to the monitor.
Off	Off	Blank	Press power key to switch on There may be a slight delay before the image reappears.

Caring for your monitor

Be sure to turn off the power before you perform any maintenance on the monitor.

Do not:

- Apply water or liquid directly to your monitor.
- Use solvents or abrasives.
- Use flammable cleaning materials to clean your monitor or any other electrical equipment.
- Touch the screen area of your monitor with sharp or abrasive items. This type of contact may cause permanent damage to your screen.
- Use any cleaner which contains an anti-static solution or similar additives. This may harm the coating of the screen area.

Do:

- Lightly dampen a soft cloth with water and use this to gently wipe the covers and the screen.
- Remove grease or finger marks with a damp cloth and a little mild detergent.

Detaching the monitor base and stand

Step 1: Place the monitor on a soft and flat surface

Step 2: Remove the screws from stand before detaching stand from the monitor.

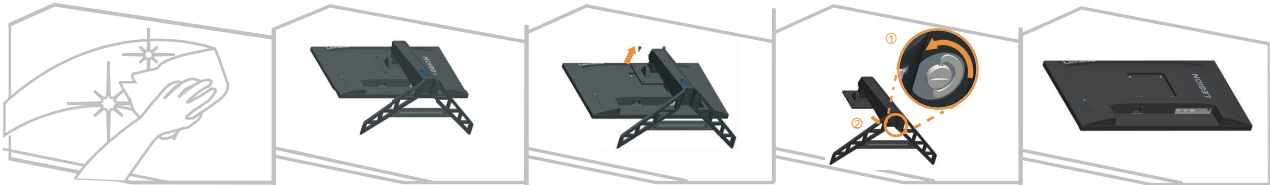

Wall Mounting (Optional)

Refer to the instructions that come with the base mounting kit. To convert your LCD display from a desk-mounted to a wall-mounted display, do the following:

Step 1: Verify that the Power button is turned Off, then disconnect the power cord.

Step 2: Lay the LCD display face down on a towel or blanket.

Step 3: Remove the base and stand from the monitor, refer to "Detaching the monitor base and stand" on page 2-8.

Step 4: Attach the mounting bracket from the VESA compatible wall mounting kit. (100mm x100mm distance), the type of VESA mounting screw is M4 x 10 mm.



Step 5: Attach the LCD display to the wall, and follow the instructions in the wall-mounting kit. For use only with UL Listed Wall Mount Bracket with minimum weight/load: 8kg

Note:

When you use a flexible arm, do not tilt the monitor downward by more than 5 degrees.

Chapter 3. Reference information

This section contains monitor specifications, instructions to manually install the monitor driver, troubleshooting information.

Monitor specifications

Table 3-1. Monitor specifications for type-model G23245FRI

Dimensions	Depth	258.8 mm (10.19 in.)
	Height	364.2~499.2 mm (14.34~19.65 in.)
	Width	557.3 mm (21.94 in.)
Stand	Tilt	Range: -5°~22°
VESA mount	Supported	100 mm (3.94 in.)
Image	Viewable image size	622.3 mm (24.5 in.)
	Maximum height	302.62 mm (11.91 in.)
	Maximum width	543.74 mm (21.41 in.)
	Pixel pitch	0.2832 mm(H) x 0.2802 mm(V)
Power input	Rating	100-240 VAC 47~63 Hz 1.2 A
Power consumption	Normal operation	<30 W (max) <19.15 W (Typical)
	Standby/Suspend	<0.5 W (Digital)
	Off	<0.3 W at 100VAC and 240VAC
Video input DP (Digital)	Interface	DP
	Input signal	VESA TMDS (Panel Link™)/DP
	Horizontal addressability	1920 pixels (max)
	Vertical addressability	1080 lines (max)
	Clock frequency	610 MHz
Video input HDMI (Digital)	Interface	HDMI
	Input signal	VESA TMDS (Panel Link™)/HDMI
	Horizontal addressability	1920 pixels (max)
	Vertical addressability	1080 lines (max)
	Clock frequency	600 MHz

Communications	VESA DDC/CI	
Supported Display Modes	Horizontal frequency	HDMI 30 KHz-255 KHz DP 255 KHz-255 KHz
	Vertical frequency	48 Hz - 240Hz
	Native Resolution	1920 x 1080 at 240 Hz
Temperature	Operating	0° to 40°C (32°F to 104° F)
	Storage	-20° to 60°C (-4°F to 140° F)
	Shipping	-20° to 60°C (-4° F to 140° F)
Humidity	Operating	10% to 80% non-condensing
	Storage	5% to 95% non-condensing
	Shipping	5% to 95% non-condensing

Troubleshooting

If you have a problem setting up or using your monitor, you might be able to solve it yourself. Before calling your dealer or Lenovo, try the suggested actions that are appropriate to your problem.

Table 3-2. Troubleshooting

Problem	Possible cause	Suggested action	Reference
The words "Out of Range" are shown on the screen, and the power indicator is flashing white	The system is set to a display mode which is not supported by the monitor	<ul style="list-style-type: none"> • If you are replacing an old monitor, reconnect it and adjust the display mode to within the specified range for your new monitor. • If using a Windows system, restart the system in safe mode, then select a supported display mode for your computer. • If these options do not work, contact the Customer Support Centre. 	"Selecting a supported display mode" on page 2-7
The image quality is unacceptable	The video signal cable is not connected with the monitor or system completely.	Be sure the signal cable is firmly plugged into the system and monitor.	"Connecting and turning on your monitor" on page 1-4
	The color settings may be incorrect.	Select another color setting from the OSD menu.	"Adjusting your monitor image" on page 2-3
	The automatic image setup function was not performed.	Perform automatic image setup.	"Adjusting your monitor image" on page 2-3
The power indicator is not lit and there is no image.	<ul style="list-style-type: none"> • The monitor's power switch is not switched on. • The power cord is loose or disconnected. • There is no power at the outlet. 	<ul style="list-style-type: none"> • Be sure the power cord is connected properly. • Be sure the outlet has power. • Power on the monitor. • Try using another power cord. • Try using another electrical outlet. 	"Connecting and turning on your monitor" on page 1-4
Screen is blank and power indicator is amber.	The monitor is in Standby / Suspend mode	<ul style="list-style-type: none"> • Press any key on the keyboard or move the mouse to restore operation. • Check the Power options settings on your computer. 	"Understanding power management" on page 2-7
The power indicator is amber, but there is no image	The video signal cable is loose or disconnected from the system or monitor	Be sure the video cable is connected with the system properly	"Connecting and turning on your monitor" on page 1-4
	The monitor brightness and contrast are at the lowest setting.	Adjust the brightness and contrast setting on the OSD menu.	"Adjusting your monitor image" on page 2-3

Problem	Possible cause	Suggested action	Reference
One or more of the pixels appear discolored	This is a characteristic of the LCD technology and is not an LCD defect	If there are more than five pixels missing, contact the Support Center	"Appendix A, Service and Support" on page A-1
<ul style="list-style-type: none"> • Fuzzy lines in text or a blurry image • Horizontal or vertical lines through the image. 	<ul style="list-style-type: none"> • Image setup has not been optimized • Your system Display Properties setting have not been optimized. 	Adjust the resolution settings on your system to match the native resolution for this monitor: HDMI : 1920 x 1080 / 240Hz DP : 1920 x 1080 / 240Hz.	"Adjusting your monitor image" on page 2-3
		Perform automatic image setup. If automatic image setup does not help, perform manual image setup.	"Selecting a supported display mode" on page 2-7
		When working in the native resolution, you may find additional improvements by adjusting the Dots Per Inch (DPI) setting on your system.	See the Advanced section of your system's display properties.

Manually installing the monitor driver

Below are steps for manually installing the monitor driver in Microsoft Windows 10, Microsoft Windows 11.

1. Turn off the computer, all attached devices.
2. Ensure that the monitor is connected correctly.
3. Turn on the monitor and then the system unit. Allow your computer to start the Windows operating system.
4. From the Lenovo website https://pcsupport.lenovo.com/solutions/r25f_30, find the corresponding monitor driver and download it to a PC to which this monitor is connected (such as a desktop).
5. Right-click the Windows **Start** button on the desktop, then click **Device Manager**, and double click **Monitor**.
6. Double-click **Generic Monitor**.
7. Click the **Driver** tab.
8. Click **Update Driver**, and then click **Browse Computer to find the driver**.
9. Click **Let me pick from a list of available drivers on my computer**.
10. Click the **Have Disk...** button. By clicking the **Browse** button, browse and point to the following path: **X:\Monitor Drivers\Windows** (where X indicates “the folder in which the downloaded driver is located” (such as a desktop)).
11. Select **r25f-30.inf** file, Click **Open** button. Click **OK** button.
12. In the new window, select **R25f-30** and click **Next**.
13. After the installation is complete, delete all downloaded files and close all Windows.
14. Restart the system. The system will automatically select the refresh rate and the corresponding color matching profile.

Appendix A. Service and Support

The following information describes the technical support that is available for your product, during the warranty period or throughout the life of the product. Refer to your Lenovo Statement of Limited Warranty for a fully explanation of Lenovo warranty terms.

Registering your option

Register to receive product service and support updates, as well as free and discounted computer Accessories and content. Go to: <http://www.lenovo.com/support>

Online technical support

Online technical support is available during the life of your product through the Lenovo Support Web site at <http://www.lenovo.com/support>

Product replacement assistance or exchange of defective components also is available during the warranty period, assistance for replacement or exchange of defective components is available. In addition, if your option is installed in a Lenovo computer, you might be entitled to service at your location. Your technical support representative can help you determine the best alternative.

Telephone technical support

Installation and configuration support through the Customer Support Center will be available until 90 days after the option has been withdrawn from marketing. After that time, the support is cancelled, or made available for a fee, at Lenovo's discretion. Additional support is also available for a nominal fee.

Before contacting a Lenovo technical support representative, please have the following information available: option name and number, proof of purchase, computer manufacturer, model, serial number and manual, the exact wording of any error message, description of the problem, and the hardware and software configuration information for your system.

Your technical support representative might want to walk you through the problem while you are at your computer during the call.

Telephone numbers are subject to change without notice. The most up-to-date telephone list for Lenovo Support is always available at: <http://www.lenovo.com/support>

Country or Region	Telephone Number
China	400-990-8888
South Africa	800982393
Argentina	0800-444-24.522(Spanish)
Australia	1300-557-073
Austria	800295730(German)
Belgium	80076524(French, Dutch)
Bolivia	800-100-764(Spanish)

Appendix B. Notices

Lenovo may not offer the products, services, or features discussed in this document in all countries. Consult your local Lenovo representative for information on the products and services currently available in your area. Any reference to a Lenovo product, program, or service is not intended to state or imply that only that Lenovo product, program, or service may be used. Any functionally equivalent product, program, or service that does not infringe any Lenovo intellectual property right may be used instead. However, it is the user's responsibility to evaluate and verify the operation of any other product, program, or service.

Lenovo may have patents or pending patent applications covering subject matter described in this document. The furnishing of this document does not give you any license to these patents. You can send license inquiries, in writing to:

*Lenovo (United States), Inc.
1009 Think Place - Building One
Morrisville, NC 24.5560
U.S.A.
Attention: Lenovo Director of Licensing*

LENOVO PROVIDES THIS PUBLICATION "AS IS" WITHOUT WARRANTY OF ANY KIND, EITHER EXPRESS OR IMPLIED, INCLUDING, BUT NOT LIMITED TO THE IMPLIED WARRANTIES OF NON-INFRINGEMENT, MERCHANTABILITY OR FITNESS FOR A PARTICULAR PURPOSE.

Some jurisdictions do not allow disclaimer of express or implied warranties in certain transactions, therefore, this statement may not apply to you.

This information could include technical inaccuracies or typographical errors. Changes are periodically made to the information herein; these changes will be incorporated in new editions of the publication. Lenovo may make improvements and/or changes in the product(s) and/or the program(s) described in this publication at any time without notice.

The products described in this document are not intended for use in implantation or other life support applications where malfunction may result in injury or death to persons. The information contained in this document does not affect or change Lenovo product specifications or warranties. Nothing in this document shall operate as an express or implied license or indemnity under the intellectual property rights of Lenovo or third parties. All information contained in this document was obtained from specific environments and presented as an illustration. The result obtained in other operating environments may vary.

Lenovo may use or distribute any of the information you supply in any way it believe appropriate without incurring any obligation to you.

Any references in this publication to non-Lenovo Web sites are provided for convenience only and do not in any manner serve as an endorsement of those Web sites. The materials at those Web sites are not part of the materials for this Lenovo product, and use of those Web sites is at your own risk.

Any performance data contained herein was determined in a controlled environment. Therefore, the result obtained in other operating environments may vary significantly. Some measurements may have been made on development-level systems and there is no guarantee that these measurements will be the same on generally available systems. Furthermore, some measurements may have been estimated through extrapolation. Actual results may vary. Users of this document should verify the applicable data for their specific environment.

Recycling information

Lenovo encourages owners of information technology (IT) equipment to responsibly recycle their equipment when it is no longer needed. Lenovo offers a variety of programs and services to assist equipment owners in recycling their IT products. For information on recycling Lenovo products, go to:

<http://www.lenovo.com/recycling>

環境配慮に関して

本機器またはモニターの回収リサイクルについて

企業のお客様が、本機器が使用済みとなり廃棄される場合は、資源有効利用促進法の規定により、産業廃棄物として、地域を管轄する県知事あるいは、政令市長の許可を持った産業廃棄物処理業者に適正処理を委託する必要があります。また、弊社では資源有効利用促進法に基づき使用済みパソコンの回収および再利用・再資源化を行う「PC回収リサイクル・サービス」を提供しています。詳細は、https://www.lenovo.com/jp/ja/services_warranty/recycle/pcrecycle/をご参照ください。

また、同法により、家庭で使用済みとなったパソコンのメーカー等による回収再資源化が2003年10月1日よりスタートしました。詳細は、https://www.lenovo.com/jp/ja/services_warranty/recycle/pcrecycle/をご参照ください。

重金属を含む内部部品の廃棄処理について

本機器のプリント基板等には微量の重金属（鉛など）が使用されています。使用後は適切な処理を行うため、上記「本機器またはモニターの回収リサイクルについて」に従って廃棄してください。

Collecting and recycling a disused Lenovo computer or monitor

If you are a company employee and need to dispose of a Lenovo computer or monitor that is the property of the company, you must do so in accordance with the Law for Promotion of Effective Utilization of Resources. Computers and monitors are categorized as industrial waste and should be properly disposed of by an industrial waste disposal contractor certified by a local government. In accordance with the Law for Promotion of Effective Utilization of Resources, Lenovo Japan provides, through its PC Collecting and Recycling Services, for the collecting, reuse, and recycling of disused computers and monitors. For details, visit the Lenovo Web site at https://www.lenovo.com/jp/ja/services_warranty/recycle/pcrecycle/. Pursuant to the Law for Promotion of Effective Utilization of Resources, the collecting and recycling of home-used computers and monitors by the manufacturer was begun on October 1, 2003. This service is provided free of charge for home-used computers sold after October 1, 2003. For details, visit the Lenovo Web site at https://www.lenovo.com/jp/ja/services_warranty/recycle/personal/.

Disposing of Lenovo computer components

Some Lenovo computer products sold in Japan may have components that contain heavy metals or other environmental sensitive substances. To properly dispose of disused components, such as a printed circuit board or drive, use the methods described above for collecting and recycling a disused computer or monitor.

Trademarks

The following terms are trademarks of Lenovo in the United States, other countries, or both:

Lenovo
The Lenovo logo
ThinkCentre
ThinkPad
ThinkVision

Microsoft, Windows, and Windows NT are trademarks of the Microsoft group of companies.

Other company, product, or service names may be trademarks or service marks of others.

Power cords and power adapters

Use only the power cords and power adapters supplied by the product manufacturer. Do not use the ac power cord for other devices.