

Quick Start Guide

Outdoor Security Wi-Fi Camera

Set Up Camera

STEP 1

DOWNLOAD APP

Get the **Tapo** app from the App Store or Google Play.



STEP 2

POWER UP

Plug in the adapter to power up your camera.

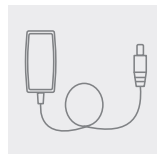

STEP 3

SET UP

Tap the ⊕ button in the app and select your model. Follow app instructions to complete setup.

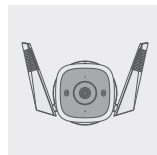

Install Your Camera

1. Drill Holes

Stick the mounting template to the desired mounting place. Drill 3 screw holes (Φ=6mm) according to the template.

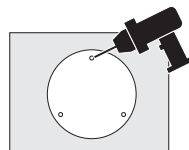

2. Mount Camera

Insert three anchors into the holes and use the screws to affix the camera over the anchors.

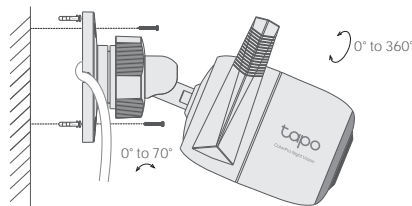

3. Connect to Power

Connect the camera to a power outlet using the provided power adapter. Install the waterproof seal for the power connectors.

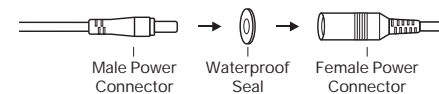

4. Install Waterproof Cable Attachments

Install the waterproof cable attachments for the network interface. Make sure each part is securely attached and the waterproof rings are flush to keep out water.

• **The Ethernet port connects to a network device.**

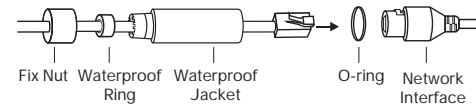

a. Route the network cable through the following components in order: fix nut, waterproof ring, and then the waterproof jacket.

b. Insert the waterproof ring into the waterproof jacket.

c. Fix the O-ring to the network interface of the camera and connect the network cables.

d. Attach the network interface with the waterproof jacket, then twist to lock. Rotate the fix nut to secure it to the waterproof jacket.

• **The Ethernet port does not connect to a network device.**

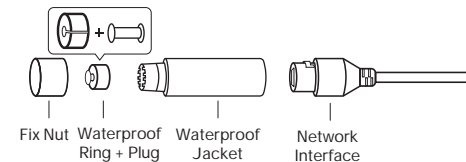

a. Insert the waterproof plug into the waterproof ring, then insert them into the waterproof jacket.

b. Attach the network interface with the waterproof jacket, then twist to lock. Rotate the fix nut to secure it to the waterproof jacket.



Appearance

Front

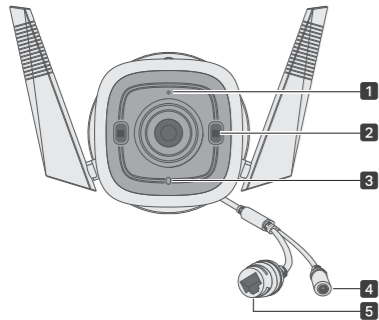

Side

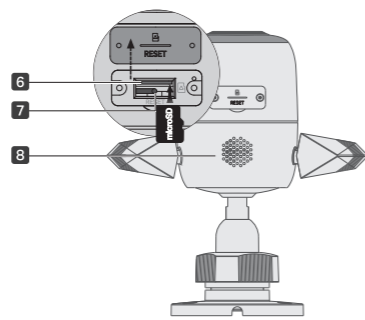

1 MIC

4 DC Power Connector
Used to connect to a 9V DC power adapter

2 White Light

5 Ethernet Port
Used to connect to a network device

3 System LED

6 microSD Card Slot
Insert a microSD card for local recording
*microSD card not included.

7 RESET
Hold for 5s to reset Wi-Fi or 10s to factory reset camera

8 Speaker

System LED Status

| | |
|--|-------------------------------------|
| Solid red | Starting up |
| Blinking red and green (for Wi-Fi setup) | Ready for setup |
| Blinking red slowly (for Wi-Fi setup) | Connecting to Wi-Fi |
| Solid amber | Connected to Wi-Fi or wired network |
| Solid green | Connected to the cloud |
| Blinking red quickly | Camera resetting |
| Blinking green quickly | Camera updating |

FAQ (Frequently Asked Questions)

Q1. What should I do if I fail to configure Tapo Camera?

- Visit <https://www.tp-link.com/support/faq/2747/> for detailed instructions.

Q2. What should I do if the SD card is not working properly?

- Make sure you are using a microSD card.
- It's recommended to use a Class 10 microSD card or higher, with storage from 8 GB to 512 GB.
- Make sure you have initialized the microSD card in the Tapo app.
- If the problem still persists, contact our technical support.

Q3. How do I reset the camera?

- With the camera powered on, press and hold the Reset button for about 5s until the System LED blinks red quickly to reset the Wi-Fi while keeping other settings; for 10s to factory reset the camera.
- Open the Tapo app, go to the Camera Settings page, and remove the camera to factory reset it.

For more questions, please refer to <https://www.tp-link.com/support/faq/2742/>

For technical support, the user guide, and more information, please visit www.tapo.com/support/



- Do not use damaged charger or USB cable to charge the device.
- Do not use any other chargers than those recommended.
- Do not use the device where wireless devices are not allowed.
- Adapter shall be easily accessible.
- Use only power supplies which are provided by manufacturer and in the original packing of this product. If you have any questions, please don't hesitate to contact us.
- Keep the device away from fire or hot environments. DO NOT immerse in water or any other liquid.
- Do not disassemble, repair or modify the product.
- Do not use the product if the casing has been broken. Danger of electric shock.
- Never touch the product with wet hands.
- Do not place near automatically controlled devices such as fire alarms. Radio waves emitted from this product may cause such devices to malfunction resulting in an accident.
- Observe restrictions on using wireless products in fuel depots, chemical plants or when blasting operations are in progress.
- Do not use liquid to clean the product. Only use a dry cloth.
- Never put metal objects inside the product. If a metal object enters the product turn off the circuit breaker and contact an authorised electrician.
- This product is not intended to be used when providing medical care. Consult the manufacturer of any personal medical devices, such as pacemakers or hearing aids to determine if they are adequately shielded from external RF (radio frequency) energy.
- Do not use this product in health care facilities. Hospitals or health care facilities may be using equipment that could be sensitive to external RF energy.
- Do not place heavy objects on top of the product.
- When you leave the product unused for a long time unplug the product from the power outlet.
- Adapter should be used indoors where the ambient temperature is lower than or equal to 40 °C.
- This product may interfere with other electronic products such as TV, radios, personal computers, phones or other wireless devices.
- Operating Temperature: -20°C~45°C (-4°F ~113 °F)

Please read and follow the above safety information when operating the device. We cannot guarantee that no accidents or damage will occur due to improper use of the device. Please use this product with care and operate at your own risk.
TP-Link hereby declares that the device is in compliance with the essential requirements and other relevant provisions of directives 2014/53/EU, 2009/125/EC, 2011/65/EU and (EU)2015/863. The original EU declaration of conformity may be found at <https://www.tapo.com/support/ce>
TP-Link hereby declares that the device is in compliance with the essential requirements and other relevant provisions of the Radio Equipment Regulations 2017. The original UK declaration of conformity may be found at <https://www.tapo.com/support/ukca/>

