

Operating Instructions

Thank you very much for choosing SLIK product. SLIK Corporation has designed a sturdy, rugged, dependable product that will provide you with many years of satisfactory use. Please take a few moments to read this operating instruction manual carefully before use to take full advantage of the many fine features. Retain this operating instruction manual in case you might want to refer back to it.

⚠ Caution

This caution icon refers to information pertaining to important safety procedures in preventing injuries, or damages which may occur as a result of mishandling this product.

🚫 Prohibition

This prohibition icon refers to information pertaining to prohibited contents. Please refer to instruction closely to avoid accidents.

W308

Components

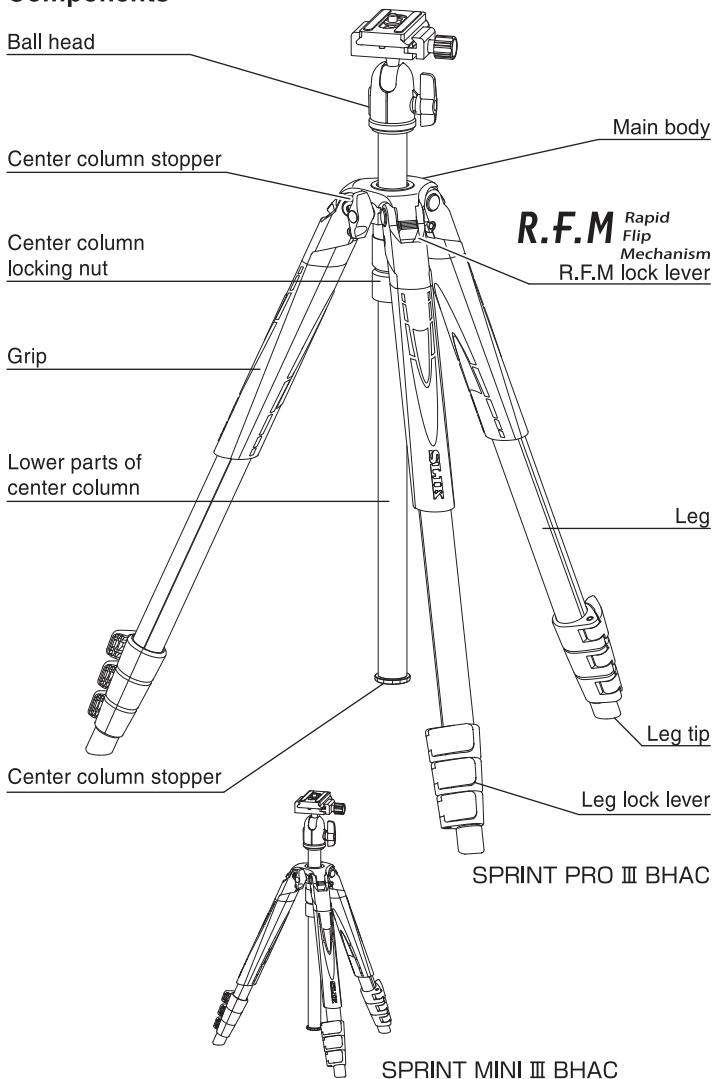

Ball head

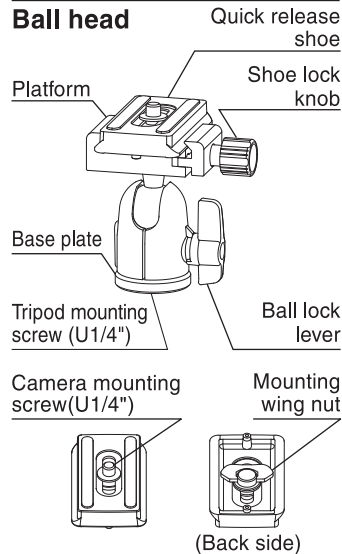

Equipment that can be loaded on this product

🚫 Prohibited

Maximum loading capacity :
2 kgs (4.4 lbs)

Do not overload. This product has been designed to handle equipment weighing under the maximum load capacity. Some equipment weighing under the maximum load capacity may not balance well due to its weight distribution. Use a larger tripod or head in such case.

Specification

SPRINT PRO III BHAC	
Max. operating height	1,605 mm (63.1 in)
Folded length	470 mm (18.5 in)
Max. center column ext.	300 mm (11.8 in)
Weight	1,075 g (2.37 lbs)

SPRINT MINI III BHAC	
Max. operating height	1,085 mm (42.7 in)
Folded length	355 mm (14 in)
Max. center column ext.	210 mm (8.2 in)
Weight	915 g (2.02 lbs)

With exclusive case

Optional accessory

6507 Quick release shoe
Cat. No. 618-822

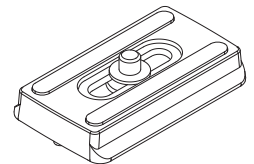

Carrying the tripod

🚫 Prohibition

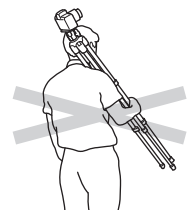

Carrying a tripod with a camera left on can result in unexpected accidents. We therefore, recommend you to remove your camera while carrying the tripod.

Setting up

⚠ Caution

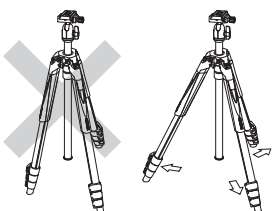

To prevent accidental falls or tripod tipping over, making sure all levers, knobs and handles on the tripod are securely tightened. And all of the three legs are opened all the way.

Attaching the camera to the quick release shoe

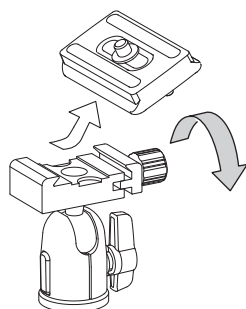

Remove the quick release shoe to loosen the shoe lock knob until the quick release shoe can be removed from the platform.

(Back side)

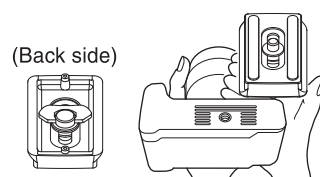

Screw the camera mounting screw on the tripod attachment screw of your camera and fix firmly.

⚠ Caution

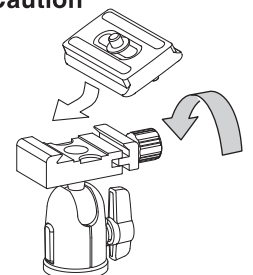

Fix the shoe lock knob firmly after inserting the quick release shoe to the platform. Please make sure the equipment is securely fixed to the ball head, before you use the ball head.

Using the ball head

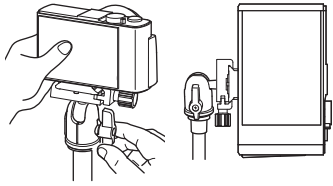

A camera can be moved freely while the ball lock lever is loosened. Tighten the ball lock lever when a camera angle is determined. Make sure to hold your camera while operating the ball lock lever.

Extending the tripod legs

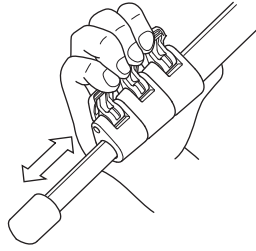

Flip the leg lock lever up to extend or shorten the section to the desired length. Press the leg lock lever(s) flush against the leg to lock.

Operating the center column

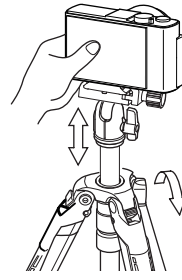

Hold the camera with one hand. Loosen the center column lock. Raise or lower the camera to desired height. While maintaining a hold, set the desired height of the camera, tighten the center column lock.

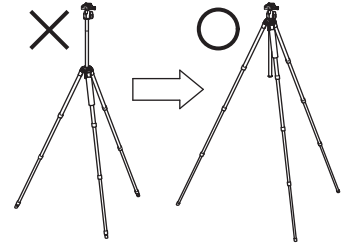

For best results and to avoid unnecessary camera vibrations, try to keep the center column height to a minimum if possible. Also use the larger legs first when extending the legs.

R.F.M Three position adjustable legs

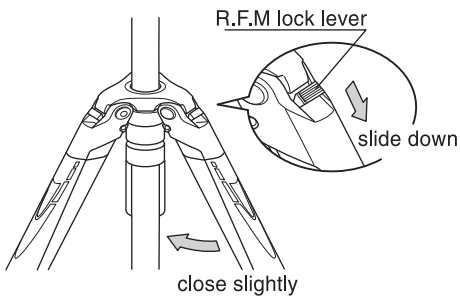

Close the leg slightly and slide the R.F.M lock lever down.

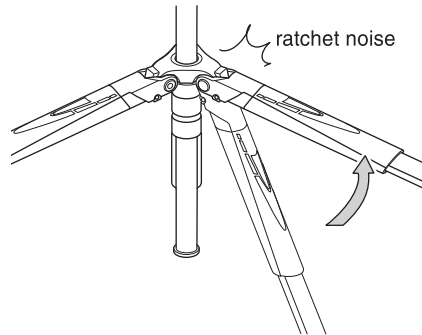

Move the leg up slowly, it will make a ratchet noise at a certain point. Move the leg up until stop, this position is the low position.

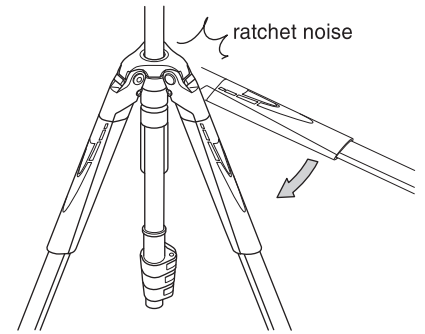

Close the leg further, a middle position or regular leg position can be chosen.

Low position

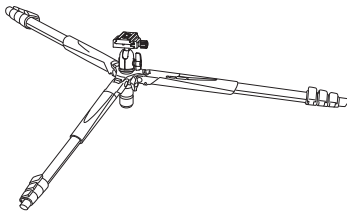

Remove the lower part of the center column when setting the legs in the lowest position.

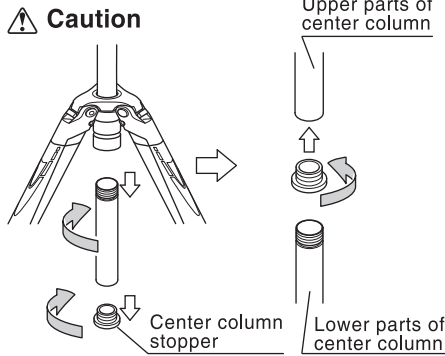

Turn the lower part of the center column in the direction of the arrow. (counter clockwise) Attach the center column stopper to the bottom of the upper center column to prevent the center column from falling out of the body.

Inverting the center column

Caution

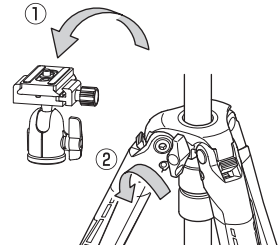

- ① Always remove the ball head first before replacing the center column.
- ② Loosen the center column lock.

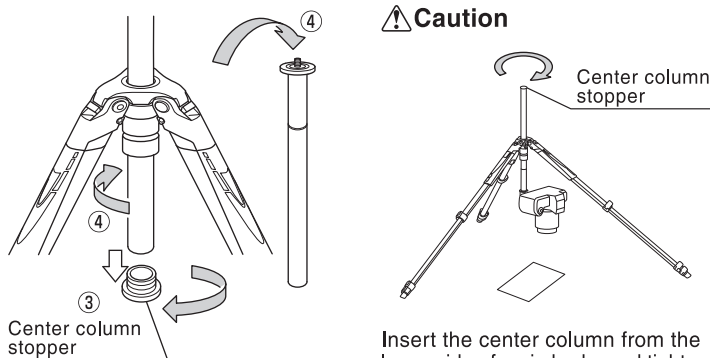

- ③ Remove the center column stopper.
- ④ Then loosen the center column stopper and pull out the center column.

Insert the center column from the lower side of main body, and tighten the center column lock. Make sure to re-attach the center column stopper in order to prevent the center column from falling out accidentally.

Care of the product

- DO NOT apply any grease or oil to this product.
- Clean with a mild detergent and a soft cloth only.
- DO NOT use close to flame. Avoid extreme heat.

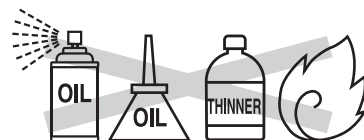

Slik Corporation reserves the right to make changes in design and/or improvements on the products without any obligation and advanced notice.

SLIK CORPORATION

853 Kayama, Hidaka City, Saitama 350-1231, Japan
Phone 81-42-989-2141, Fax. 81-42-985-0210 ©2022