

datavideo

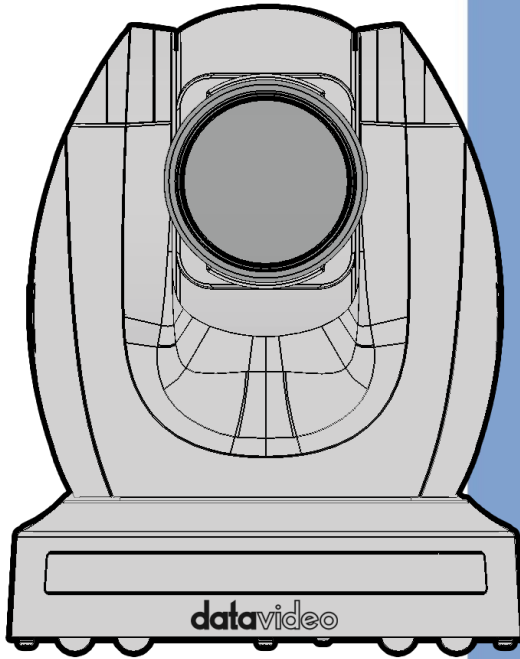

4K NDI PTZ CAMERA
PTC-280NDI

Instruction Manual

www.datavideo.com

Table of Contents

TABLE OF CONTENTS	2
FCC COMPLIANCE STATEMENT	5
WARNINGS AND PRECAUTIONS	5
WARRANTY	7
<i>STANDARD WARRANTY</i>	7
<i>THREE YEAR WARRANTY</i>	7
DISPOSAL	8
1. PRODUCT OVERVIEW	9
FEATURES	9
2. LOCATION AND FUNCTION OF PARTS	10
3. BASIC SETUP	14
3.1 POWER-ON INITIALIZATION	14
3.2 VIDEO OUTPUT	14
<i>HDMI Video Output</i>	16
<i>3G-SDI Video Output</i>	16
4. HOW TO USE THE NDI STUDIO MONITOR SOFTWARE	17
4.1 NDI INTRODUCTION	17
5. REMOTE CONTROL AND ON-SCREEN MENU	22
5.1 REMOTE CONTROL FUNCTIONS	22
5.2 OSD MENU	27
5.3 PROFESSIONAL JARGON EXPLANATIONS OF THE OSD MENU	38
6. INSTRUCTION FOR INSTALLATION	39
7. NETWORK CONNECTION	45
7.1 DHCP MODE	46
7.2 STATIC IP	48
7.3 DVIP	49
8. WEB USER INTERFACE	52

8.1	LIVE	52
8.2	VIDEO.....	53
8.2.1	<i>How to Connect the PTC-280NDI to a Datavideo Switcher after a 60FPS/50FPS Video Streaming (Take the HS-1300 as an example)</i>	<i>57</i>
8.3	IMAGE	61
8.4	AUDIO.....	63
8.5	SYSTEM.....	66
8.6	NETWORK	68
8.7	NDI® CONFIG.....	76
8.8	INFORMATION.....	78
8.9	THE PTZ CONTROL AREA OF THE WEB UI.....	80
9.	HOW TO USE THE WEB UI TO SET AND CALL PRESETS	83
10.	DIP SWITCH SETTINGS	84
10.1	DIP SWITCH SW1	84
10.2	DIP SWITCH SW2 (IRID)	85
11.	HOW TO PLAY THE RTSP STREAM BY THE VLC PLAYER.....	86
12.	HOW TO PLAY THE MULTICAST BY THE VCL PLAYER	88
13.	HOW TO STREAM TO FACEBOOK.....	89
14.	HOW TO STREAM TO YOUTUBE.....	100
15.	HOW TO DO THE SRT STREAMING BY THE VMIX SOFTWARE	104
16.	REMOTE CONTROL PORT PINOUTS	114
17.	FIRMWARE UPDATE.....	116
17.1	FIRMWARE UPDATE BY THE PTC-280NDI FIRMWARE UPDATE TOOL.....	116
17.2	FIRMWARE UPDATE BY THE USB FLASH DRIVE.....	120
18.	FREQUENTLY-ASKED QUESTIONS.....	123
19.	DIMENSIONS.....	125
20.	SPECIFICATIONS.....	126
	SERVICE AND SUPPORT	132

Disclaimer of Product and Services

The information offered in this instruction manual is intended as a guide only. At all times, Datavideo Technologies will try to give correct, complete and suitable information. However, Datavideo Technologies cannot exclude that some information in this manual, from time to time, may not be correct or may be incomplete. This manual may contain typing errors, omissions or incorrect information. Datavideo Technologies always recommend that you double check the information in this document for accuracy before making any purchase decision or using the product. Datavideo Technologies is not responsible for any omissions or errors, or for any subsequent loss or damage caused by using the information contained within this manual. Further advice on the content of this manual or on the product can be obtained by contacting your local Datavideo Office or dealer.

FCC Compliance Statement

This device complies with part 15 of the FCC rules. Operation is subject to the following two conditions:

- (1) This device may not cause harmful interference, and
- (2) This device must accept any interference received, including interference that may cause undesired operation.

Warnings and Precautions

1. Read all of these warnings and save them for later reference.
2. Follow all warnings and instructions marked on this unit.
3. Unplug this unit from the wall outlet before cleaning. Do not use liquid or aerosol cleaners. Use a damp cloth for cleaning.
4. Do not use this unit in or near water.
5. Do not place this unit on an unstable cart, stand, or table. The unit may fall, causing serious damage.
6. Slots and openings on the cabinet top, back, and bottom are provided for ventilation. To ensure safe and reliable operation of this unit, and to protect it from overheating, do not block or cover these openings. Do not place this unit on a bed, sofa, rug, or similar surface, as the ventilation openings on the bottom of the cabinet will be blocked. This unit should never be placed near or over a heat register or radiator. This unit should not be placed in a built-in installation unless proper ventilation is provided.
7. This product should only be operated from the type of power source indicated on the marking label of the AC adapter. If you are not sure of the type of power available, consult your Datavideo dealer or your local power company.
8. Do not allow anything to rest on the power cord. Do not locate this unit where the power cord will be walked on, rolled over, or otherwise stressed.

9. If an extension cord must be used with this unit, make sure that the total of the ampere ratings on the products plugged into the extension cord do not exceed the extension cord's rating.
10. Make sure that the total amperes of all the units that are plugged into a single wall outlet do not exceed 15 amperes.
11. Never push objects of any kind into this unit through the cabinet ventilation slots, as they may touch dangerous voltage points or short out parts that could result in risk of fire or electric shock. Never spill liquid of any kind onto or into this unit.
12. Except as specifically explained elsewhere in this manual, do not attempt to service this product yourself. Opening or removing covers that are marked "Do Not Remove" may expose you to dangerous voltage points or other risks, and will void your warranty. Refer all service issues to qualified service personnel.
13. Unplug this product from the wall outlet and refer to qualified service personnel under the following conditions:
 - a. When the power cord is damaged or frayed;
 - b. When liquid has spilled into the unit;
 - c. When the product has been exposed to rain or water;
 - d. When the product does not operate normally under normal operating conditions. Adjust only those controls that are covered by the operating instructions in this manual; improper adjustment of other controls may result in damage to the unit and may often require extensive work by a qualified technician to restore the unit to normal operation;
 - e. When the product has been dropped or the cabinet has been damaged;
 - f. When the product exhibits a distinct change in performance, indicating a need for service.

Warranty

Standard Warranty

- Datavideo equipment are guaranteed against any manufacturing defects for one year from the date of purchase.
- The original purchase invoice or other documentary evidence should be supplied at the time of any request for repair under warranty.
- The product warranty period begins on the purchase date. If the purchase date is unknown, the product warranty period begins on the thirtieth day after shipment from a Datavideo office.
- All non-Datavideo manufactured products (product without Datavideo logo) have only one year warranty from the date of purchase.
- Damage caused by accident, misuse, unauthorized repairs, sand, grit or water is not covered under warranty.
- Viruses and malware infections on the computer systems are not covered under warranty.
- Any errors that are caused by unauthorized third-party software installations, which are not required by our computer systems, are not covered under warranty.
- All mail or transportation costs including insurance are at the expense of the owner.
- All other claims of any nature are not covered.
- All accessories including headphones, cables, and batteries are not covered under warranty.
- Warranty only valid in the country or region of purchase.
- Your statutory rights are not affected.

Three Year Warranty

- All Datavideo products purchased after July 1st, 2017 are qualified for a free two years extension to the standard warranty, providing the product is registered with Datavideo within 30 days of purchase.



- Certain parts with limited lifetime expectancy such as LCD panels, DVD drives, Hard Drive, Solid State Drive, SD Card, USB Thumb Drive, Lighting, Camera module, PCIe Card are covered for 1 year.
- The three-year warranty must be registered on Datavideo's official website or with your local Datavideo office or one of its authorized distributors within 30 days of purchase.

Disposal

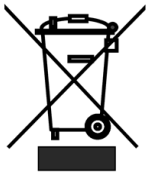

For EU Customers only - WEEE Marking

This symbol on the product or on its packaging indicates that this product must not be disposed of with your other household waste. Instead, it is your responsibility to dispose of your waste equipment by handing it over to a designated collection point for the recycling of waste electrical and electronic equipment. The separate collection and recycling of your waste equipment at the time of disposal will help to conserve natural resources and ensure that it is recycled in a manner that protects human health and the environment. For more information about where you can drop off your waste equipment for recycling, please contact your local city office, your household waste disposal service or the shop where you purchased the product.

1. Product Overview

The PTC-280NDI features a large 1/2.5" CMOS sensor, supports high-quality 2160p50/60 UHD video output, features 12x optical zoom, 16x digital zooms and supports versatile outputs, including 3G-SDI, HDMI, IP stream and NDI. The PTC-280NDI series is the ideal choice for taking your remote camera production to the next level.

Features

- PTZ Camera for Supporting 2160p50/59.94/60 Resolutions.
- Supports 12x Optical Zoom and 16x Digital Zoom.
- Supports 4K Video Output Interfaces including HDMI and H.264/H.265 Streaming.
- Supports 2160p and 1080p (3G-SDI) Simultaneous video output.
- Supports RS-422 Serial Port Control.
- Supports External Audio Input interface: 3.5mm Audio In/Line In (switchable on the web UI).
- Provides Friendly Web UI.

2. Location and Function of Parts

Front of Camera	
	
1	Lens Built-in 1/2.5" 8.51M Pixel CMOS 4K color camera with white balance control, backlight compensation, automatic gain and etc.
2	Tally LED Tally lamp will be turned ON upon receiving the ON signal.
3	Sensor for Remote Control Remote control IR receiver

Rear of Camera



1	<p>USB Port</p> <p>This USB port is used for updating firmware. Users can save the latest version of firmware in a USB flash drive and then insert it into this interface for firmware updating.</p> <p>Note: After inserting the USB flash drive, please remember to turn “ON” the SETUP->USB UPGRADE from the OSD menu of the PTC-280NDI camera.</p>
2	<p>Power Input</p> <p>DC in socket connects the supplied 12V PSU. The connection can be secured by screwing the outer fastening ring of the DC In plug to the socket.</p>

3	<p>4K HDMI OUT</p> <p>The 4K HDMI OUT allows you to connect an external HDMI monitor via an HDMI cable.</p>
4	<p>3G-SDI OUT</p> <p>The 3G-SDI OUT allows you to connect an external monitor via an SDI cable.</p>
5	<p>MIC IN/LINE IN</p> <p>The 3.5mm audio input receives external audio.</p>
6	<p>RS-422 Interface (RJ-45)</p> <p>The RS-422 interface serves to connect external RS-422 devices. Use an Ethernet cable to connect external RS-422 controllers. See “Section 16 Remote Control Port Pinouts” for making the cable for the RS-422 interface.</p> <p>Note: If users want to switch between the RS-422 and DVIP communication protocols, please use the No.4 pin of the DIP Switch which is located at the bottom of the PTC-280NDI. Please switch this pin to “ON” for operating in DVIP mode. If this pin is switched to “OFF”, it will operate in “RS-422” mode.</p>
7	<p>IRID Interface</p> <p>This interface allows users to use the DVIP Switch to control the numbering of the camera on the remote controller. Users can use this interface to set the camera to any number from No.1 to No. 4 in order to use remote controller to control the camera.</p>
8	<p>NDI® HX & DVIP Interface</p> <p>NDI® HX interface allows users to connect the PTC-280NDI and a PC to the RJ-45 Ethernet interfaces of the same router by using an RJ-45 Ethernet cable. Moreover, users can set the PC and the PTC-280NDI camera in the same local area network for controlling some functions of the PTC-280NDI camera by NewTek’s “NDI Studio Monitor” software.</p> <p>The most important benefit that the NDI brings to users is that it allows the output screen of the PTC-280NDI camera to be auto-recognized by the NDI compatible receiving devices (e.g. Notebook PC) which are set in the same local area network.</p> <p>The DVIP interface allows users to control the PTC-280NDI camera by the proprietary DVIP protocol which is developed by Datavideo.</p>

Bottom of Camera

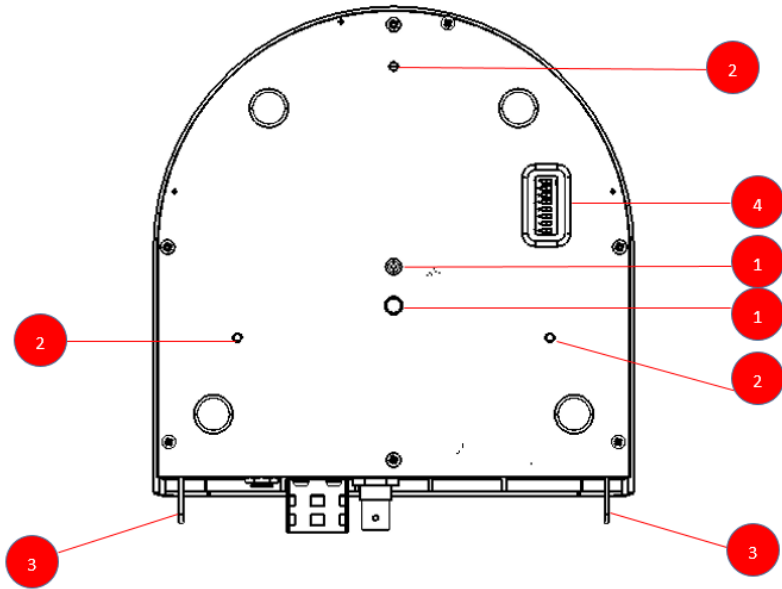

1 **Tripod Screw Hole** allows the user to mount the camera on the tripod.

2 **Screw Hole**
Screw holes for ceiling bracket mounting.

3 **For Safety Rope**
Ties safety rope for fixing the camera to the ceiling.

4 **DIP Switch**
This DIP Switch allows users to adjust needed parameters such as VISCA ID, resolutions, remote control protocol and video modes.

3. Basic Setup

3.1 Power-On Initialization

As shown in the diagram below, after you plug in the power cord, the tally light in the front will start flashing red and will be OFF as soon as the power-on initialization is complete. The camera head should be at the HOME position with the lens facing front. After that, the camera lens will turn to the position which the camera is turned off for the last time.



Connect the DC 12 V power adapter

3.2 Video Output

You are allowed to view the camera video via **NDI® | HX & DVIP, 4K HDMI OUT** and **3G-SDI OUT**.

NDI® | HX & DVIP Port



Please follow following steps for viewing the camera video from the web UI.

- **Connect the PTC-280NDI camera directly to your PC/Notebook PC**

1. Connect the PTC-280NDI to your PC or laptop by an Ethernet Cable.
2. Open the web UI by the connected PC or laptop and then please enter the default IP address into the address bar of the web browser.

Note: The default static IP address of the PTC-280NDI is 192.168.100.88.

3. The login page of the web UI will be opened, please enter the user name and password (the default user name and password are admin/admin).
4. Open the preview window for previewing the video which is shot by the camera.

- **Connect the PTC-280NDI camera to your PC or laptop by a router.**

1. Please set the Ethernet IP address of your PC or laptop as 192.168.100.x(x means 0-255) and it will be at the same local area network as the PTC-280NDI.
2. Please use an RJ-45 Ethernet cable to connect from the DVIP port on the rear panel of the PTC-280NDI to the LAN port of a router. And then please use another RJ-45 Ethernet cable to connect from the RJ-45 Ethernet port of your PC or laptop to the LAN port of the same router.
3. Please open the web UI from the connected PC or laptop and then please enter the default IP address of the camera into the address bar of the web browser.

Note: The default static IP address of the PTC-280NDI is 192.168.100.88.

4. The login page of the web UI will be opened, please enter the user name and password (the default user name and password are admin/admin).

5. Click into the preview window on which the video will be displayed.

HDMI Video Output



Connect the 4K HDMI OUT to an external connected monitor using an HDMI cable.

3G-SDI Video Output



Connect the SDI OUT to an external connected monitor using an SDI cable.

4. How to Use the NDI Studio Monitor Software



4.1 NDI Introduction

NDI is an Ethernet-based open video and audio transmission standard. NDI allows bilateral video and audio signal transmission for devices which are located within the same Local Area Network. It provides low-latency and real-time features which make it an ideal solution for the live production application.

4.2. How to Use the NDI Studio Monitor Software (Take Windows for example) (Take NDI Tools for Windows v.5.0.5.0 for example)

Please follow following steps for using the NDI Studio Monitor software.

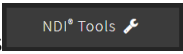
1. At first, please make sure that your PTC-280NDI camera and your laptop are connected to a router and they are set in the same LAN.
2. Please go to NewTek official website <https://www.ndi.tv/>. After that, please

click NDI Tools  and then click “Download”  from “NDI Tools for Windows” to download the latest version NDI Tools software.

3. After the installation is finished, please click “Studio Monitor” to open the NDI Studio Monitor software.

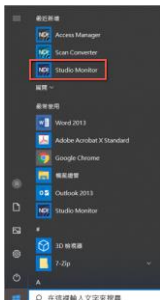

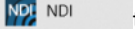
You can also click “NDI”  to open the “NDI Launcher” which is shown in the following diagram. After that, please click the “Studio Monitor” from the NDI Launcher panel to enter the Studio Monitor interface.

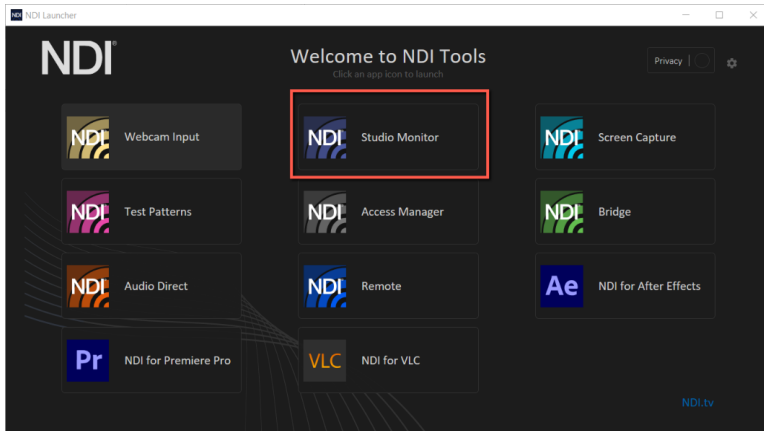

4. After the Studio Monitor Software is opened, the interface will be shown in the following diagram.

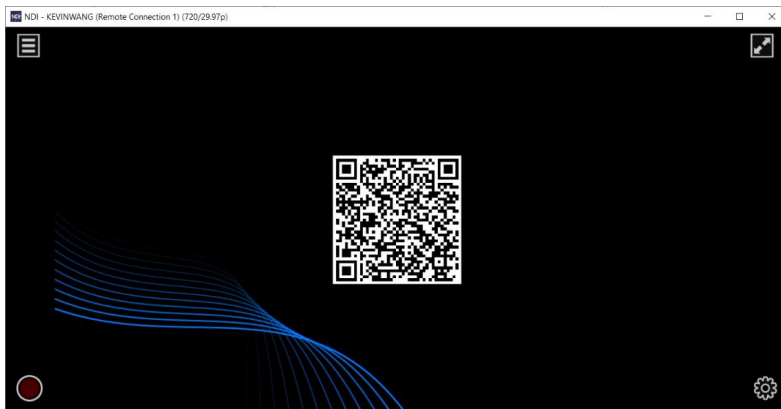

5. Please move your mouse to the up-left corner and then press the Menu button, and then you can see the menu of the Studio Monitor software. You can also right-click your mouse on the NDI Studio interface to show the menu.

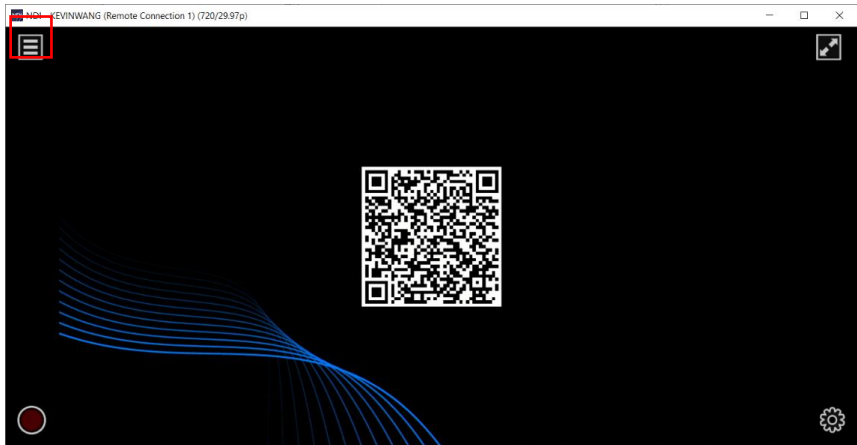

6. In the menu, you can see that the PTC-280NDI camera which is connected in the same LAN is detected by the Studio Monitor software. Please click it and then you can see the screen which is shot by the PTC-280NDI camera in the following diagram.

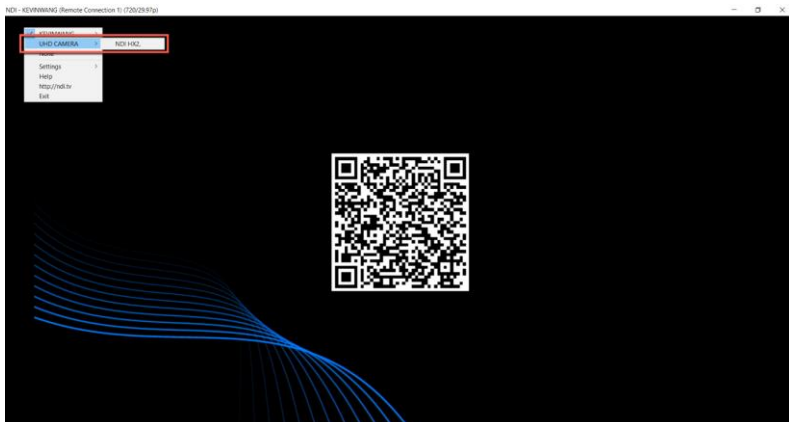

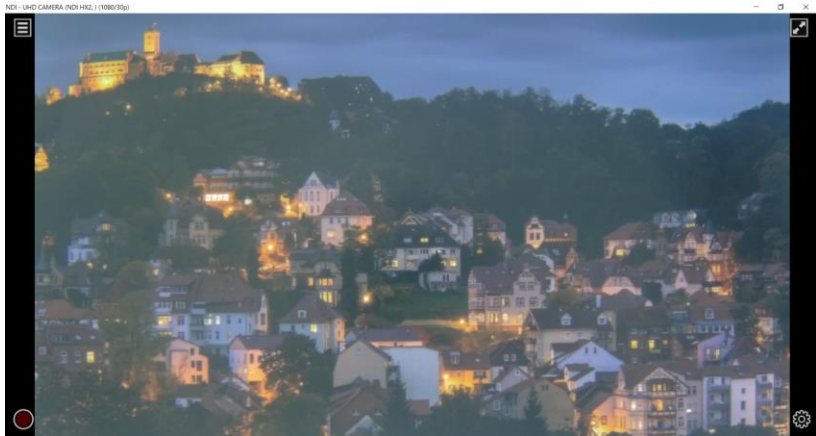

7. Please select “Settings->PTZ Settings->Show PTZ Controls” from the menu. After that, the PTZ control interface will be shown in the NDI Studio Monitor interface for users to control various functions including panning and tilting of the camera lens, Auto Focus, Zooming in/Zooming Out of the camera lens and the preset saving and recalling.

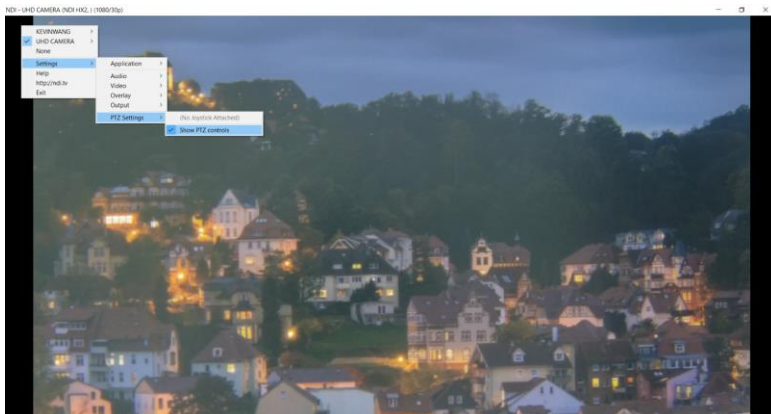

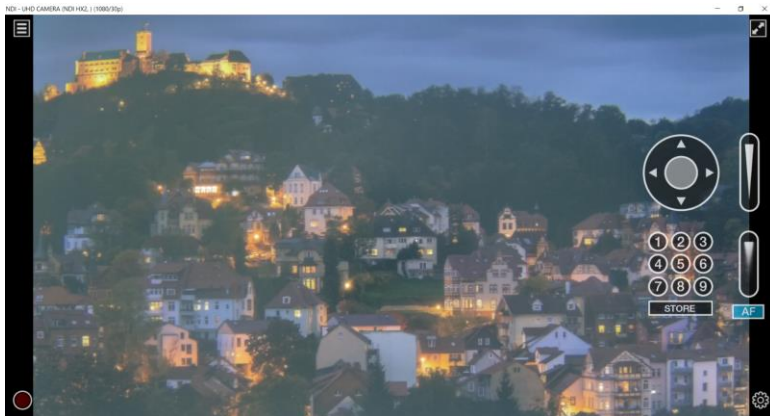



Note: If you have any problems when installing or using the NDI Studio Monitor software, please refer to NewTek NDI website <https://www.ndi.tv/> or please contact NewTek NDI Technical Support Team.



5. Remote Control and On-Screen Menu





This chapter provides an overview of remote control functions and OSD menu.



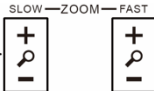

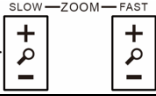
5.1 Remote Control Functions



No	Function Keys	Descriptions
1	<p style="text-align: center;">Standby Key</p> 	<p>Standby Key Press this button once to enter Standby Mode, press it again to enter Normal Mode. Note: The power consumption in Standby Mode is approximately half of the power consumption in Normal Mode.</p>
2	<p style="text-align: center;">Number Keypad</p> 	<p>Number Keypad Set, recall and clear presets using the number keypad.</p> <p>Set Preset At first, please press PRESET, and then please press any of the 0~9 number key to save the PTZ position.</p> <p>Call Preset Press any of the number key to recall the PTZ position which is saved by the Preset function.</p> <p>Note: Make sure the preset that you want to recall contains PTZ settings before pressing the number key.</p> <p>Clear Preset</p> <ul style="list-style-type: none"> At first, please press the RESET button and then please press any number key to delete the PTZ position which is saved in corresponding Preset No. Moreover, users can press 【*】 + 【#】 + 【RESET】 to delete all PTZ positions which are saved in all Preset numbers at one time.
3 & 11	<p style="text-align: center;">Asterisk and Pound Keys</p> 	<p>The asterisk and pound keys form various combinations with other keys to access certain functions directly.</p> <p>(1) 【*】 + 【#】 + 【1】 : Set OSD MENU language to English.</p> <p>(2) 【*】 + 【#】 + 【3】 : Set OSD MENU language to Chinese.</p> <p>(3) 【*】 + 【#】 + 【4】 : Show current IP address.</p>

No	Function Keys	Descriptions
		(4) 【*】 + 【#】 + 【6】 : Restore default value rapidly. (5) 【*】 + 【#】 + 【8】 : Check camera version. (6) 【*】 + 【#】 + 【9】 : Set upside down setting rapidly. (7) 【*】 + 【#】 + 【MANUAL】 : Restore default IP address.
4	<p>PRESET Button</p> 	<p>Set Preset Position Press PRESET to set presets. See <i>Number Keypad</i> description for instructions.</p>
5	<p>Home Key</p> 	<p>Home Key Press Home to return the camera head to the center. Note: In the OSD menu, press Home to enter the selected option item and MENU to exit.</p>
6	<p>Return Key</p> 	<p>Return Key Press this key to return to last level of the OSD menu.</p>
7	<p>Zoom in Slowly(SLOW+)/ Zoom out Slowly(SLOW-)</p> 	<p>Zoom in Slowly(SLOW+)/ Zoom out Slowly(SLOW-) Press this key to zoom in the camera lens slowly(SLOW+) or to zoom out the camera lens slowly(SLOW-).</p>

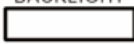
No	Function Keys	Descriptions
	<p>Zoom in Fastly(FAST+)/ Zoom out Fastly(FAST-)</p> 	<p>Zoom in Fastly(Fast+)/ Zoom out Fastly(Fast-)</p> <p>Press this key to zoom in the camera lens fastly(FAST+) or to zoom out the camera lens fastly(FAST-).</p>
8	<p>L/R SET Key</p> 	<p>Left/Right Setting Key</p> <p>Press this L/R SET key and combine this key with the number key 1 and number key 2 to set the panning-tilting directions of the camera lens.</p> <ul style="list-style-type: none"> Press the L/R SET plus number key 1 (STD) simultaneously to set the panning direction to be the same as the left/right direction setting in the OSD menu. Press the L/R SET plus number key 2 (REV) simultaneously to set the panning direction to opposite direction compared to the left/right direction setting in the OSD menu.
9	<p>Focus Keys</p> 	<p>Focus Keys</p> <p>Those keys are used for Focus adjusting.</p> <p>Press the AUTO key to focus the focus to the center of the object.</p> <p>Press the MANUAL key to focus the focus to the center of the object manually.</p> <p>Press the MANUAL key and then use the FAR button (Focus to FAR) or the NEAR button (Focus to NEAR) to adjust the focal length manually.</p>
10	<p>CAMERA SELECT</p> 	<p>Camera Selection Keys</p> <p>Users can use the IRID DIP Switch which is located on the rear panel of the PTC-28ONDI to assign the ID number to camera among the multi-camera scene. After that, please switch between the four cameras by using the Camera Select keys.</p>

No	Function Keys	Descriptions
12	<p>RESET Button</p> 	<p>Clear Preset</p> <p>Press RESET and corresponding 0-9 Number keys to clear preset. Please see Number Keypad description for instructions.</p>
13	<p>PTZ Control Keys</p> 	<p>PTZ Control Keys</p> <p>Press the arrow buttons for panning and tilting operations. Press the Home key for turning the camera lens from the back side to the front side.</p>
14	<p>MENU Key</p> 	<p>MENU</p> <p>Press this key for entering or exiting the OSD menu.</p>
15	<p>Backlight BACKLIGHT</p> 	<p>Backlight BLC ON/OFF: Press this key for turning on the backlight compensation function, press this key again for turning off the backlight compensation function.</p>
16	<p>PTZ Reset Button</p> 	<p>PTZ Reset Button</p> <p>Press this key and then the camera will do the default self-testing.</p>
17	<p>Image Freezing button</p> 	<p>Image Freezing Button</p> <p>Press this key once and then no matter how the camera head is moved, the camera image will be frozen on current image. Press this button again will unfreeze the image.</p>

5.2 OSD Menu

On-Screen Menu allows the user to modify various camera settings. Press **[MENU]** on the **remote control** to open the on-screen menu as shown below.

OSD Menu
Exposure
Color
Image
P/T/Z
Noise Reduction
Setup
Communication Setup
Information
Restore Default
【Home】 Enter
【Menu】 Exit

The table below summarizes the main option items and their sub-options.

Main Options							
	Exposure	Color	Image	P/T/Z	Noise Reduction	Setup	Communication Setup
Sub-Options	Mode	WB Mode	Luminance	SpeedByZoom	NR2D-Level	Language	Protocol
	ExpComp Mode	RG	Contrast	AF-Zone	NR3D-Level	HDMI RGB Mode	V_Address
	Backlight	BG	Sharpness	AF-Sense		Video Format	V_AddrFix
	Gain Limit	Saturation	Flip-H	L/R Set		Audio Select	Net Mode
	Anti-Flicker	Hue	Flip-V	Display Info		SDI-3G Mode	Baudrate
	Meter	AWB Sens	B&W-Mode	Image Freeze		USB UPGRADE	
	DRC		Gamma	Digital Zoom		VISCA ID	
			Style	Pre Speed		Audio Channel	
				Pre Zoom Speed			

	Information	Restore Default
Sub-Options	ARM	Restore? Yes/No
	SOC	
	Model	
	Date	
	AF	
	Format	
	Lens	
	IP	
	GateWay	
	NetMask	
	CTRL SRC	

Details of all options in the on-screen menu are listed in the table below.

Main Menu	Sub Menu	Options	Options
Exposure	Mode	Auto	
		Manual	
		SAE	
		AAE	
		Bright	
	ExpCompMode	Off	
		On	ExpComp -7~+7
	Backlight	Off	
		On	
	Gain Limit	0	
		1	
		2	
		3	
		4	
		5	
		6	
		7	
		8	
		9	
		10	
		11	
		12	
		13	
		14	
		15	
		16	
		17	
		18	
	19		
	20		
	21		
	22		
Anti-Flicker	Off		
	50Hz		
	60Hz		
Meter	Average		
	Center		
	Smart		
	Top		
DRC	0		
	1		
	2		

	3
	4
	5
	6
	7
	8
Iris	F1.8
	F2.0
	F2.4
	F2.8
	F3.4
	F4.0
	F4.8
	F5.6
	F6.8
	F8.0
	F9.6
	F11.0
	Close
Shutter	1/30
	1/60
	1/90
	1/100
	1/125
	1/180
	1/250
	1/350
	1/500
	1/725
	1/1000
	1/1500
	1/2000
	1/3000
	1/4000
	1/6000
1/10000	
Gain	0
	1
	2
	3
	4
	5
	6
	7
	8
	9
	10
	11
	12
	13
14	

		15	
		16	
		17	
		18	
		19	
		20	
		21	
		22	
	Bright	0	
		1	
		2	
		3	
		4	
		5	
		6	
		7	
		8	
		9	
	Color	WB Mode	10
			11
			12
			13
14			
15			
RG Tuning		16	
		17	
		Auto	
		Indoor	
		Outdoor	
		OnePush	
		Manual	
		VAR	
BG Tuning	0		
	+1		
	+2		
	+3		
	+4		
	+5		
	+6		
	+7		
	+8		
	+9		
+10			
	0		
	+1		
	+2		
	+3		
	+4		
	+5		
	+6		
	+7		

	+8
	+9
	+10
Saturation	60%
	70%
	80%
	90%
	100%
	110%
	120%
	130%
	140%
	150%
	160%
	170%
	180%
	190%
200%	
Hue	0
	1
	2
	3
	4
	5
	6
	7
	8
	9
	10
	11
	12
	13
	14
AWB Sens	High
	Middle
	Low
RG	0~255
BG	0~255
Color Temp	2500K
	2600K
	2700K
	2800K
	2900K
	3000K
	3100K
	3200K
	3300K
	3400K
	3500K

		3600K	
		3700K	
		3800K	
		3900K	
		4000K	
		4100K	
		4200K	
		4300K	
		4400K	
		4500K	
		4600K	
		4700K	
		4800K	
		4900K	
		5000K	
		5100K	
		5200K	
		5300K	
		5400K	
		5500K	
		5600K	
		5700K	
		5800K	
		5900K	
		6000K	
		6100K	
		6200K	
		6300K	
		6400K	
		6500K	
		6600K	
		6700K	
		6800K	
		6900K	
		7000K	
		7100K	
		7200K	
		7300K	
		7400K	
		7500K	
		7600K	
		7700K	
		7800K	
		7900K	
		8000K	
Image	Luminance	0	
		1	
		2	
		3	
		4	
		5	

	6	
	7	
	8	
	9	
	10	
	11	
	12	
	13	
	14	
Contrast	0	
	1	
	2	
	3	
	4	
	5	
	6	
	7	
	8	
	9	
	10	
	11	
	12	
	13	
14		
Sharpness	Auto	
	0	
	1	
	2	
	3	
	4	
	5	
	6	
	7	
	8	
	9	
	10	
	11	
	12	
	13	
14		
15		
Flip-H	Off	
	On	
Flip-V	Off	
	On	
B&W-Mode	Off	
	On	
Gamma	EXT	
	PC	
	0.48	
	0.5	

		0.56	
		0.63	
	Style	Default	
		Norm	
		Bright	
		PC	
	SpeedByZoom	Off	
		On	
	AF-Zone	Front	
		Top	
		Center	
		Bottom	
	AF-Sense	High	
		Low	
		Normal	
	L/R Set	STD	
		REV	
	Display Info	Off	
		On	
	Image Freeze	On	
		Off	
	Digital Zoom	Off	
		2x	
		4x	
		8x	
		16x	
P/T/Z	Pre Speed	1	
		2	
		3	
		4	
		5	
		6	
		7	
		8	
		9	
		10	
		11	
		12	
		13	
		14	
		15	
		16	
		17	
		18	
		19	
		20	
		21	
		22	
		23	
		24	
	Pre Zoom Speed	0	

		1	
		2	
		3	
		4	
		5	
		6	
		7	
Noise Reduction	NR2D-Level	Auto	
		Off	
		1	
		2	
		3	
	NR3D-Level	4	
		5	
		Auto	
		Off	
		1	
		2	
		3	
		4	
		5	
Setup	Language	繁體	
		EN	
		中文	
		русский	
	HDMI RGB Mode	HDMI	
		DVI	
	Video Format	1080P25	
		720P50	
		1080P60	
		1080P50	
		1080I60	
		1080I50	
		1080P30	
		720P60	
		1080P29.97	
		1080I59.94	
		1080P59.94	
		720P59.94	
		4KP29.97	
		4KP59.94	
	4KP25		
	4KP30		
	4KP50		
	4KP60		
	Audio Select	MIC	
		LINE IN	

	SDI-3G Mode	LEVEL-A	
		LEVEL-B	
	USB UPGRADE	Off	
		On	
	VISCA ID	By DIP	
		By OSD	
	Audio Channel	Stereo	
		Mono	
Communication Setup	Protocol	VISCA	
		PELCO-D	
		PELCO-P	
		Auto	
	V_Address	7	
	V_AddrFix	Off	
		On	
	Net Mode	Serial	
		Paral	
	Baudrate	38400	
2400			
4800			
9600			
Information	ARM		
	SOC		
	Model		
	Date		
	AF		
	Format		
	Lens		
	IP		
	GateWay		
	NetMask		
	CTRL SRC		
Restore Default	Restore?		

5.3 Professional Jargon Explanations of the OSD Menu

There are some professional jargons or nouns which are shown in the OSD menu of the PTC-280NDI camera, please refer to this section for realizing those jargons.

- **Speed by Zoom:** When this function is turned “ON”, at the time when the zoom-in/zoom out is beginning or it is about to reach the zoom-in/zoom-out limit or users want to stop zooming in/zooming out, the zoom-in/zoom-out speed of the camera lens will be reduced linearly. When this function is turned “OFF”, the zoom-in/zoom-out speed will be consistent no matter when the camera zoom-in is started or stopped.
- **Flip-H:** This is the “Horizontal Flipping”. When “ON” is selected, the screen which is shot by the camera will flip horizontally. If “OFF” is selected, the screen will be shown in normal direction.
- **Flip-V:** This is the “Vertical Flipping”. When “ON” is selected, the screen which is shot by the camera will flip vertically. If “OFF” is selected, the screen will be shown in normal direction.
- **L/R Set:** If the “REV” is selected for this option, the panning direction of the PTC-280NDI camera lens will be opposite to the direction which is controlled by the remote controller. If the “STD” is selected for this option, the panning direction of the camera lens will be the same as the direction which is selected by the remote controller.

6. Instruction for installation

Note: Only mount the bracket on formwork or concrete surface. Do NOT mount the bracket on plasterboard.

Step 1 – DIP Switch Setting

Set the Mirror option to H+V mode.

Step 2 – One End of Retaining Wire

Attach the retaining wire to the junction box mounted on the ceiling by screwing one end of the retaining wire into a screw hole in the junction box with a screw (not supplied) as shown in the diagram below.

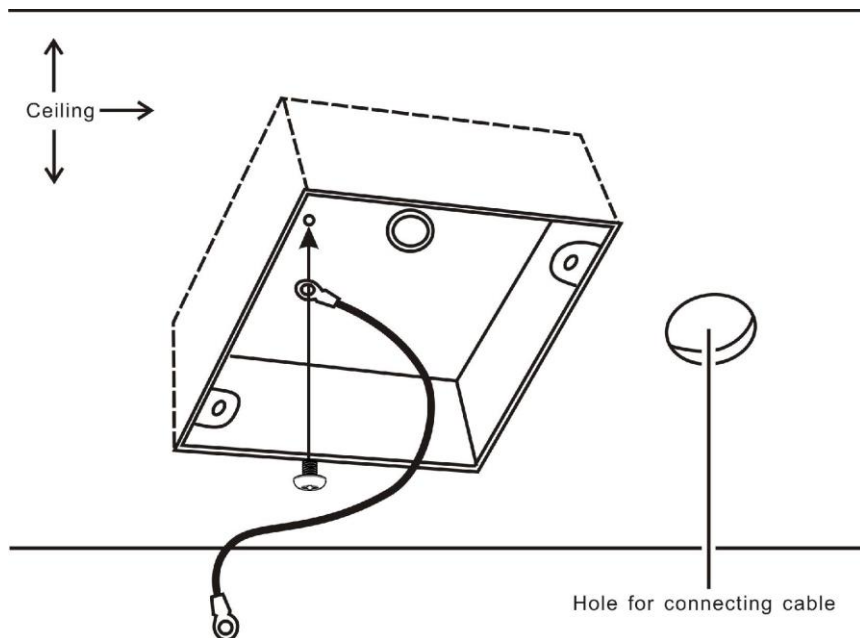

Step 3 – Ceiling Bracket (B)

Again, as illustrated in the diagram below, screw a ceiling bracket (B) into the junction box mounted on the ceiling.

Make sure the screw holes of the ceiling bracket (B) are aligned with the holes on the junction box.

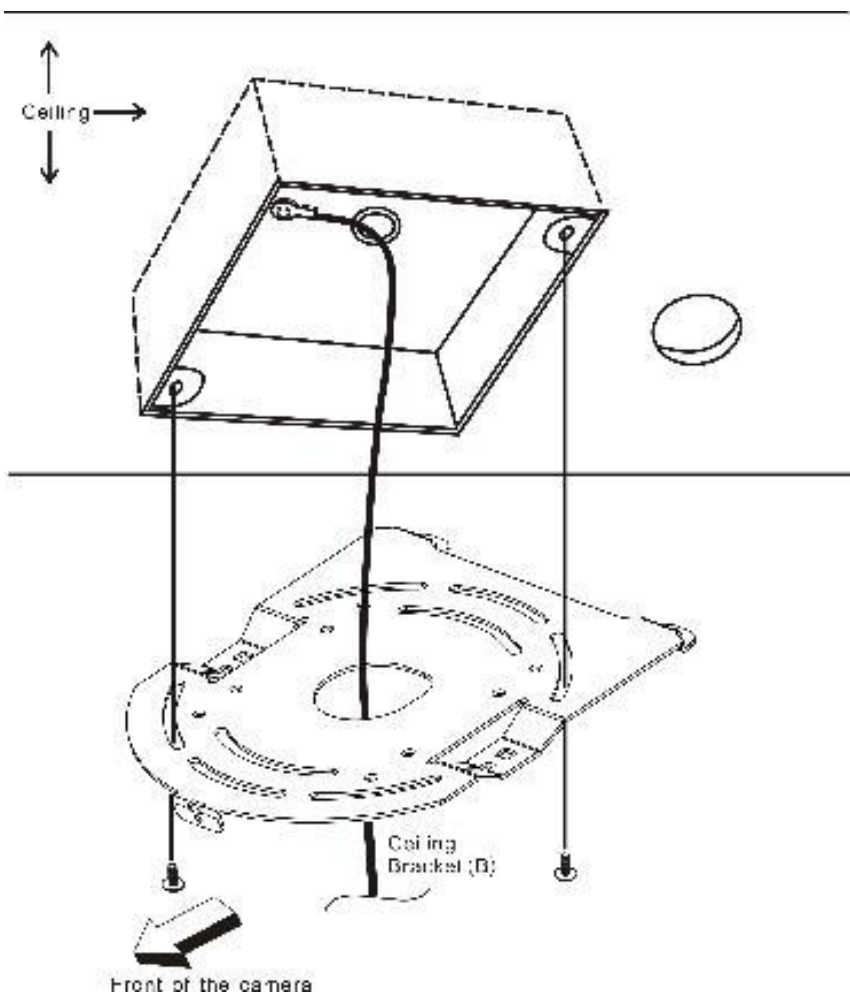

Step 4 – Ceiling Bracket (A) and Camera

- Screw ceiling bracket (A) into the bottom of the camera using three screws.
- Position the screws as shown in the diagram below.
- Align the screw holes on the bottom of the camera with those in the ceiling bracket.
- Insert the screws into the corresponding screw holes in the numbered order.
- The other end of the retaining wire is screwed into the screw hole #3.
- Securely tighten all three screws.

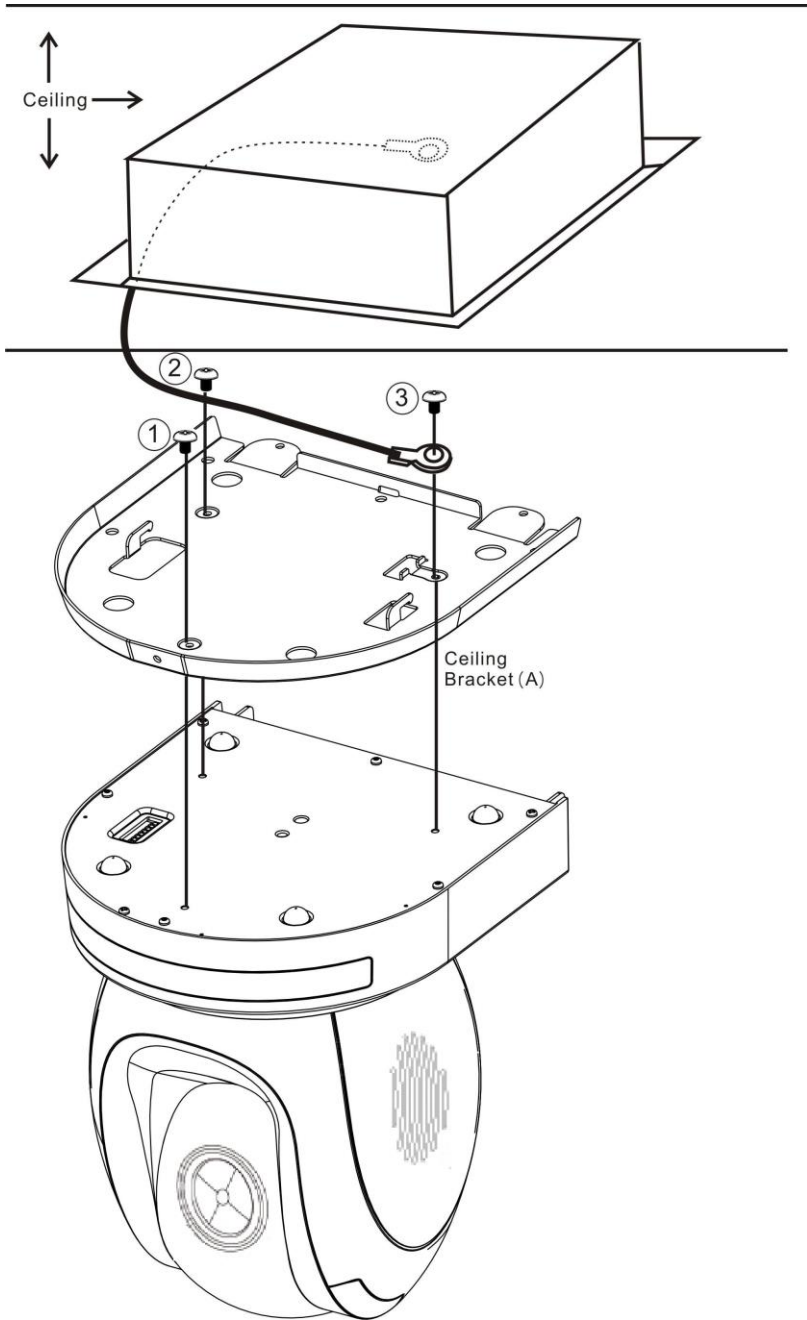

Step 5 – Mount Camera to Ceiling

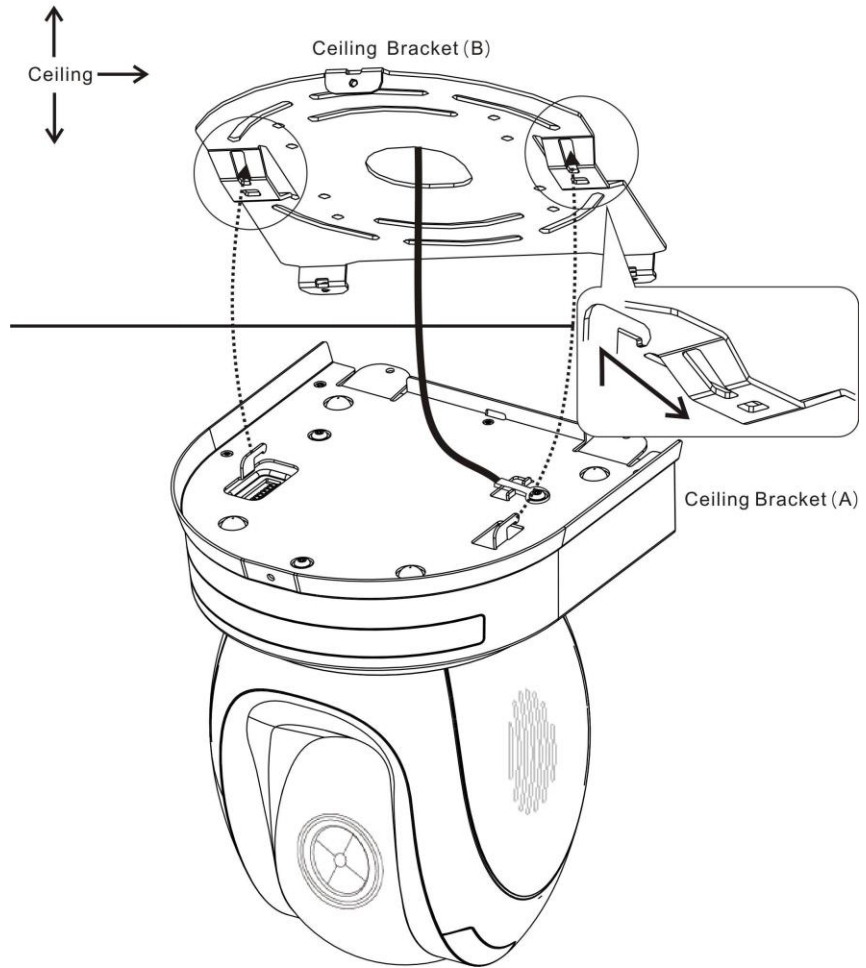

Step 6 – Screw to Fix Camera

Fix the camera by screwing three screws into the corresponding screw holes as shown in the diagram below.

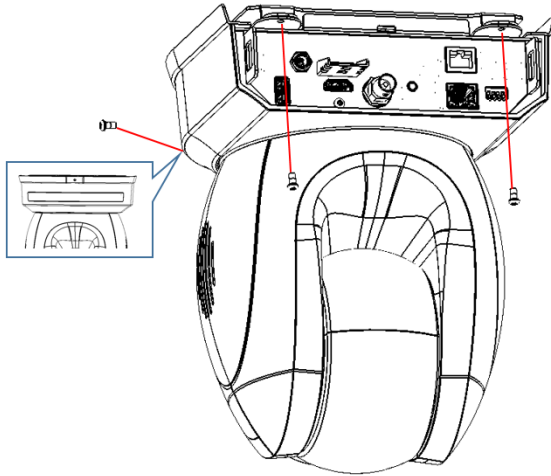

Step 7 – Cable Connection

Connect the cables to the connectors located on the rear of the camera.

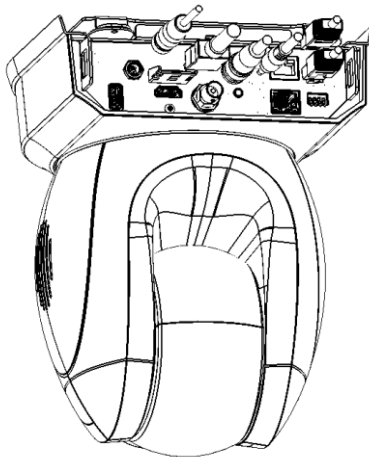

7. Network Connection

The Ethernet port on the back panel of your PTC-280NDI allows you to connect to camera from the PC/Laptop with Static or dynamic IP addresses. To access and modify these network settings, you will need to login to the camera's web interface.

If this is your first time using the device, please note that the camera's default IP address is **192.168.100.88**.

Set up direct connection between the camera and your PC/laptop as depicted in the diagram below; remember to manually assign an IP address of **192.168.100.X** to your PC/laptop.

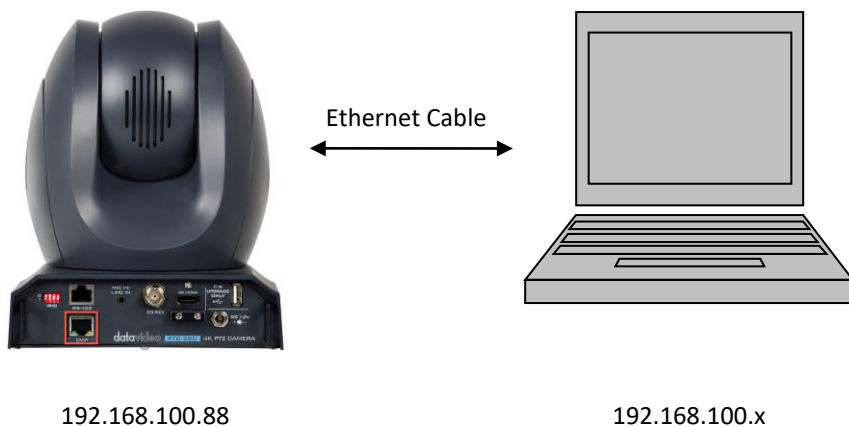

On your PC/laptop, open a web browser and in the address bar, enter the camera's default IP address, 192.168.100.88 then press the **ENTER** key which should take you to login page of the web interface.

datavideo

username

password

The default login credentials are:

- User Name: admin
- Password: admin

After users login into the web user interface successfully, please click the “Network” option and then please click the “IP Configuration Type” drop-down menu from the “Lan Settings” area to modify the connection type of the camera to DHCP or Fixed IP. If the “Fixed IP Address” is selected, it will be set in fixed IP mode. If the “Dynamic IP Address” is selected, it will be set in DHCP mode. After the setting is finished, please click the “Apply” button for completing the setting.

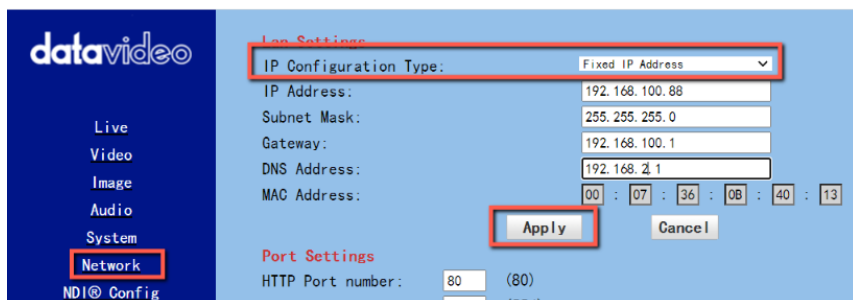

In following two chapters, we will show you how to enable DHCP and Static IP modes in two separate sections.

7.1 DHCP Mode

Dynamic Host Configuration Protocol (DHCP) is a network protocol that enables a server to automatically assign an IP address to a network device from a defined range of numbers configured for a given network. The diagram below illustrates a DHCP network connection example.

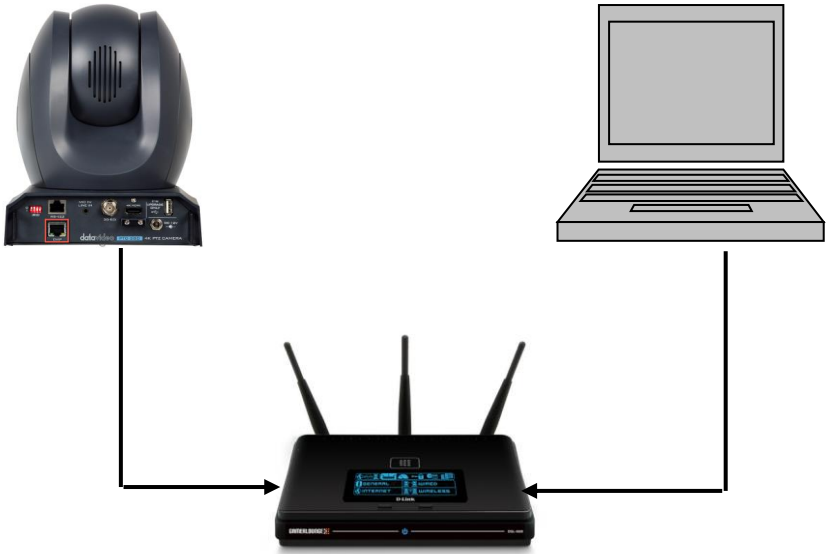

In order to enable the DHCP mode of the camera, please select “Dynamic IP Address” from the “IP Configuration Type” drop-down menu for assigning a dynamic IP address to PTC-280NDI by the router. After that, please click the “Apply” button to save the new settings and then please reboot the PTC-280NDI.

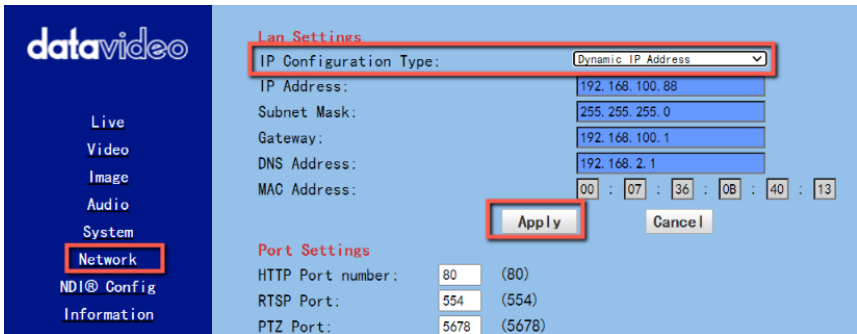

7.2 Static IP

A static IP address is a fixed address manually assigned to PTC-280NDI. First please select “Fixed IP Address” from the “IP Configuration Type” drop-down menu and then please enter an IP address for the camera, the subnet mask and the gateway IP.

Note: Never assign an address that ends in .0 or .255 as these addresses are typically reserved for network protocols. An address to the very start of the IP pool is also not recommended as it is always reserved for the router.

After the Static IP address is set, please click the “Apply” button for saving new settings and then please reboot the PTC-280NDI.

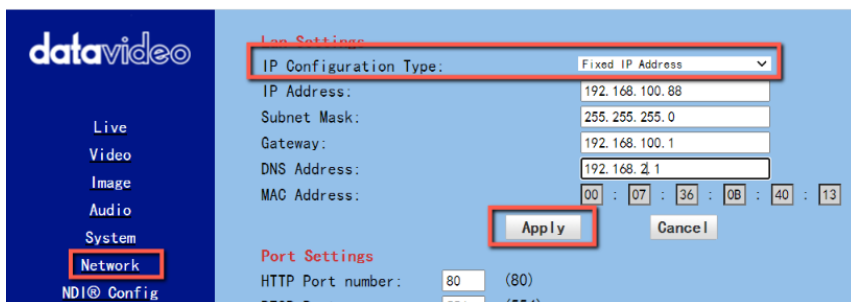

The screenshot displays the 'datavideo' web interface for 'NDI Config'. On the left, a navigation menu includes 'Live', 'Video', 'Image', 'Audio', 'System', and 'Network', with 'Network' highlighted. The main content area is titled 'LAN Settings' and contains the following fields:

- IP Configuration Type:** A dropdown menu set to 'Fixed IP Address'.
- IP Address:** 192.168.100.88
- Subnet Mask:** 255.255.255.0
- Gateway:** 192.168.100.1
- DNS Address:** 192.168.2.1
- MAC Address:** 00 : 07 : 36 : 0B : 40 : 13

Below these fields are 'Apply' and 'Cancel' buttons. A section titled 'Port Settings' is partially visible at the bottom, showing 'HTTP Port number: 80 (80)' and 'RTSP Port: 554 (554)'.

7.3 DVIP

DVIP is a special network configuration software tool designed for DVIP device search on the same network and configuring device network settings such as Hostname, DHCP mode, IP address, subnet mask, gateway IP, and primary and secondary DNS.

Depending on your operating system, download DVIP Configuration Tool from the respective sites listed as follows:

PC: <https://www.microsoft.com/en-us/p/dvip-network-config/9p6gtz839k6s?activetab=pivot%3Aoverviewtab>

Android:

https://play.google.com/store/apps/details?id=com.datavideo.dvipnetconfig&hl=en_US

iOS: <https://itunes.apple.com/tw/app/dvip-network-config/id1177895983?mt=8>

After you've installed the DVIP Network Configuration Tool, follow the steps outlined below to scan for online DVIP devices and configure their corresponding settings.

Step 1: Open the DVIP Network Configuration Tool and then select the connected Ethernet option from the "Network interface" pop-up window. After that please press the "OK" button



Step 2: After the Network interface is selected, the DVIP Network Configuration Tool interface will be shown as following diagram.

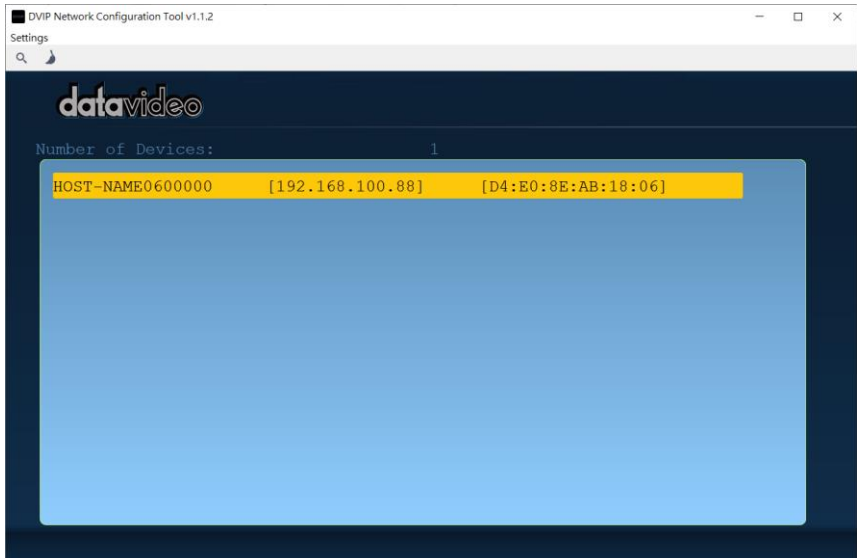

Step 3: Please press "HOST NAME" and then the network settings pop-up window will be shown.

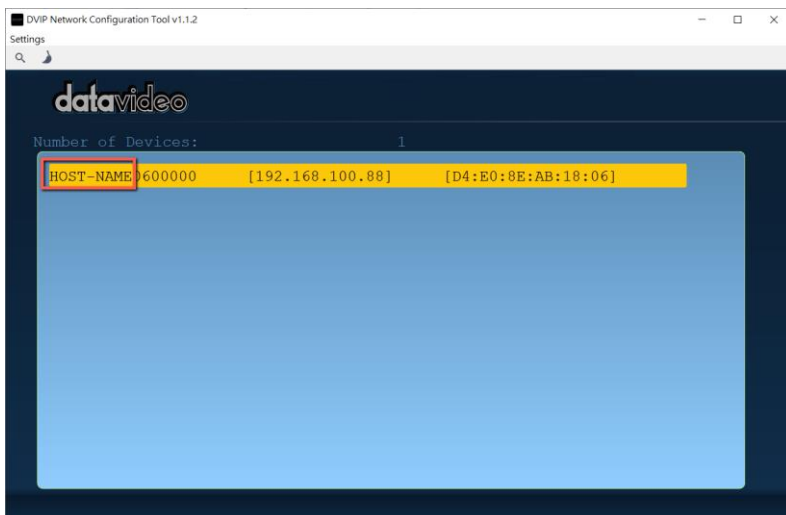

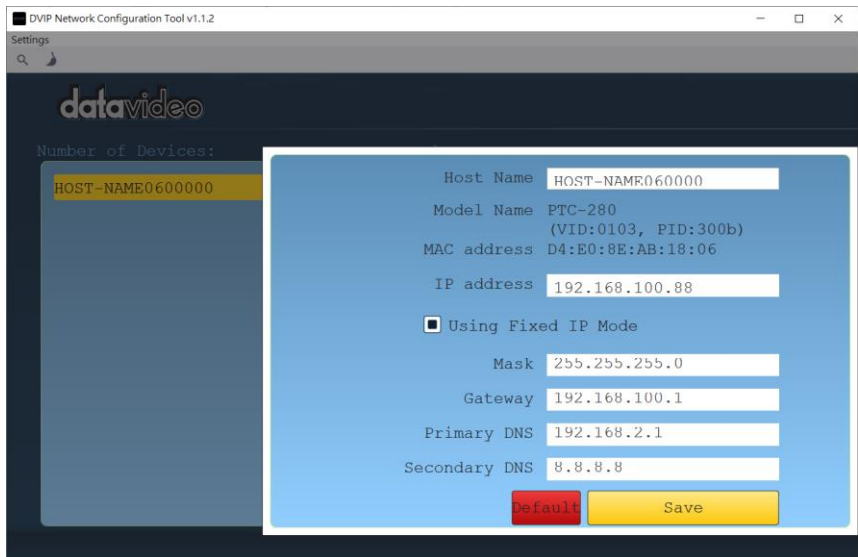

Step 4: users can click “Host Name” column for changing the device name. Users can also click each setting column for changing value if it is needed. After that, please press “Save” for saving those settings. Users can also press “Default” for resuming those settings to factory default value.

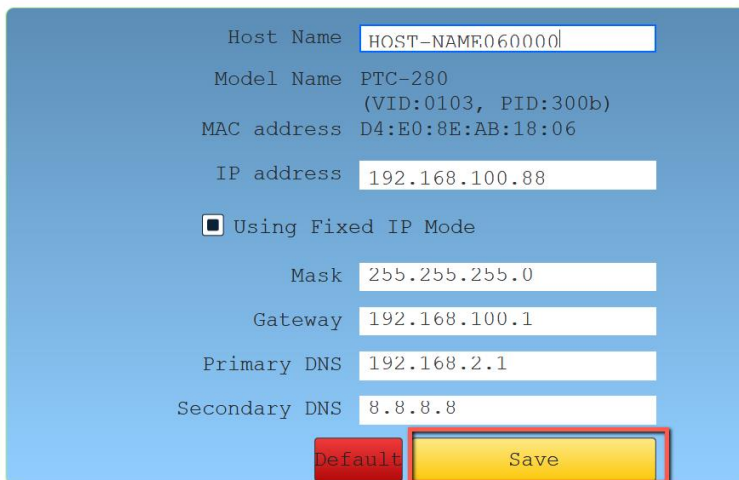

8. Web User Interface

The web based user interface allows you to set and control your PTC-280NDI devices.

8.1 Live

Live option allows users to preview the image which is shot by the PTC-280NDI in a real-time basis. Please click the “Live” option and then please select “HTML5” from the drop-down menu below the preview window. After that, users can preview the image which is shot by the PTC-280NDI camera from the preview window.

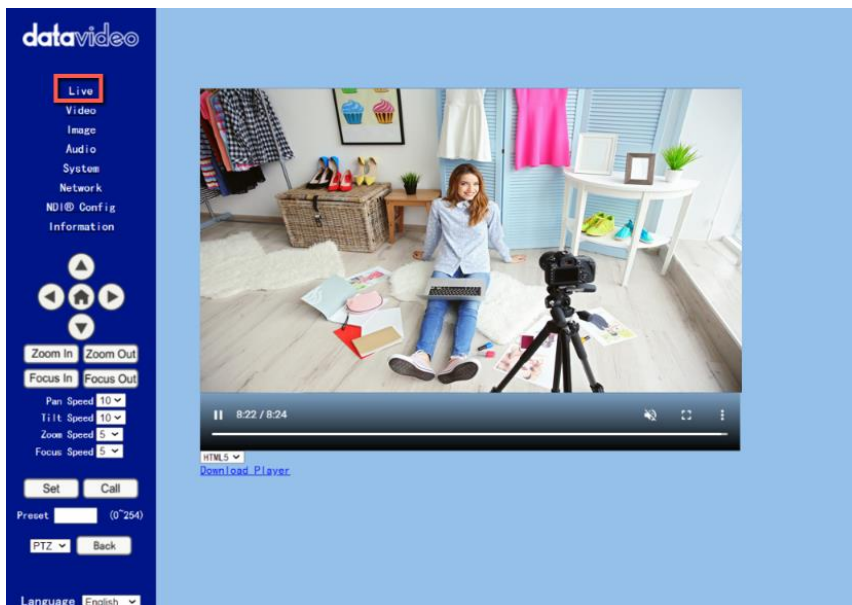

8.2 Video

“Video” option allows users to set various parameters including Video Format, Encode Level. Moreover, it also allows users to set the Encode Protocol, Resolution, Bit Rate, Frame Rate, I Key Frame Interval, Bit Rate Control, Fluctuate Level, Slice Split Enable and Slice Size for the First stream and Second stream. The main interface for the Video option is shown in the following diagram.



The screenshot displays the 'datavideo' web interface. On the left is a dark blue sidebar with navigation options: Live, Video (highlighted with a red box), Image, Audio, System, Network, NDI® Config, and Information. Below these are navigation controls: a directional pad, Zoom In/Zoom Out, Focus In/Focus Out, Pan Speed (10), Tilt Speed (10), Zoom Speed (5), Focus Speed (5), Set, Call, Preset (0~254), PTZ, and Back. At the bottom of the sidebar is a Language dropdown set to English.

The main content area is light blue and titled 'Video Settings'. It is divided into three sections:

- Video Settings:** Video Format: OSD; Encode Level: highprofile.
- First stream:** Encode Protocol: H264; Resolution: 1920x1080; Bit Rate: 4000 (32~51200) kbps; Frame Rate: 30 fps; I Key Frame Interval: 30 (2~1200); Bit Rate Control: CBR (selected); Slice Split Enable: Off; Slice Size: 68 blocks.
- Second stream:** Encode Protocol: H264; Resolution: 320x240; Bit Rate: 4096 (32~20480) kbps; Frame Rate: 30 fps; I Key Frame Interval: 60 (2~1200); Bit Rate Control: CBR (selected); Slice Split Enable: On; Slice Size: 45 blocks.

At the bottom right of the main area are 'Apply' and 'Cancel' buttons.

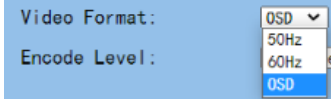
Please see following section for realizing the descriptions for each item for the Video option.

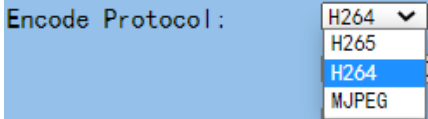
Items	Descriptions
	<p>Video Format</p> <p>It can support three video formats including 50Hz(PAL), 60Hz(NTSC) and OSD.</p>
<ul style="list-style-type: none"> ● 50Hz (PAL): If you select this option, the maximum frame rate per second (FPS) for the streaming video will be 50. ● 60Hz (NTSC): If you select this option, the maximum frame rate per second for the streaming video will be 60. ● Dial Priority: If you select this option, the maximum frame rate per second will be 30, and it is possible that the parameters including the video format and frame rate will be affected by the camera OSD menu settings. <p>Note:</p> <ol style="list-style-type: none"> 1. If you want to use the PTC-280NDI camera to connect to some Datavideo switchers which support the interlace format only such as the HS-1300, SE-120 MU and SE-650, please remember to select the “Dial Priority” option as your video format. 2. If the 50Hz or the 60Hz is selected for the PTC-280NDI web UI, the SDI or the HDMI output format of the PTC-280NDI camera will be fixed at 1080p 50/60. 	
	<p>Encode Level</p> <p>It allows users to select needed Encode Level from four Encode Levels including baseline profile, mainprofile, highprofile and svc-t.</p>
	<p>Encode Protocol (First Stream & Second Stream)</p> <p>It allows users to select three Encode Protocols including H.264, H.265 and MJPEG for the “First Stream” and “Second Stream”.</p>

Items	Descriptions
<p style="text-align: center;">Resolution for the first stream</p> <div style="border: 1px solid black; padding: 5px;"> <p>Resolution: 1920x1080 ▾</p> <p style="margin-left: 20px;">3840x2160</p> <p style="margin-left: 20px; background-color: #e0f0ff;">1920x1080</p> <p style="margin-left: 20px;">1280x720</p> <p style="margin-left: 20px;">1024x576</p> <p style="margin-left: 20px;">960x540</p> <p style="margin-left: 20px;">640x480</p> <p style="margin-left: 20px;">640x360</p> </div>	<p>Resolution (First Stream & Second Stream)</p> <p>There are two drop-down menus including the resolution for the First Stream and the resolution for the Second Stream for users to select different resolution. When the resolution is higher, the image will become clearer. However, it will occupy more network bandwidth.</p>
<p style="text-align: center;">Resolution for the second stream</p> <div style="border: 1px solid black; padding: 5px;"> <p>Resolution: 640x360 ▾</p> <p style="margin-left: 20px;">1920x1080</p> <p style="margin-left: 20px;">1280x720</p> <p style="margin-left: 20px;">1024x576</p> <p style="margin-left: 20px;">720x576</p> <p style="margin-left: 20px;">720x408</p> <p style="margin-left: 20px; background-color: #e0f0ff;">640x360</p> <p style="margin-left: 20px;">480x270</p> <p style="margin-left: 20px;">320x240</p> <p style="margin-left: 20px;">320x180</p> </div>	
<p>Bit Rate: 4096 (32~51200) kbps</p>	<p>Bit Rate (First Stream & Second Stream)</p> <p>It allows users to determine the Bit Rate range by themselves. The range for the Bit Rate for the first stream is from 32-51200kbps. The range for the Bit Rate for the second stream is from 32-20480kbps.</p> <p>Note: If the network bandwidth is too narrow and the Bit Rate setting is too high, it will cause that the video streaming can not be transferred normally and it will cause a poor visual effect for viewers.</p>
<p>Bit Rate: 1024 (32~20480) kbps</p>	

Items	Descriptions
Frame Rate: <input type="text" value="25"/> fps	<p>Frame Rate (First Stream & Second Stream)</p> <p>Users can set the Frame Rate from the drop-down menu by themselves. The range is from 1 to 60. When the Frame Rate value is higher, the image will be smoother. When the Frame Rate value is lower, it will cause an unsmooth image.</p>
I Key Frame Interval: <input type="text" value="25"/> (2~1200)	<p>I Key Frame Interval (First Stream & Second Stream)</p> <p>It allows users to set the interval between two I frames. When the interval is larger, the response speed from the viewing window will be lower.</p>
Bit Rate Control: <input type="radio"/> CBR <input checked="" type="radio"/> VBR	<p>Bit Rate Control (First Stream & Second Stream)</p> <p>There are two ways for Bit Rate Control including the CBR and VBR.</p> <p>CBR: The video encoder will encode the video according to the default speed.</p> <p>VBR: The video encoder will encode the video by adjusting the encoding speed according to the default value in order to achieve best image quality.</p>
Fluctuate Level: <input type="text" value="1"/>	<p>Fluctuate Level (First Stream & Second Stream)</p> <p>This function is used to suppress the fluctuation degree of the variable bit rate. Users can set different degrees from 1 to 6.</p>

Items	Descriptions
Slice Split Enable: <input type="radio"/> On <input checked="" type="radio"/> Off	Slice Split Enable (First Stream & Second Stream) This is used to turn on or turn off the Slice Split function.
Slice Size: <input type="text" value="68"/> blocks	Slice Size (First Stream & Second Stream) This is used to set the Slice size.
<input type="button" value="Apply"/>	Apply Key After all of the options are set, please click the “Apply” key and then all of the changes will be effective.
<input type="button" value="Cancel"/>	Cancel Key If the “Cancel” key is pressed, all of the changes will not take effect.



8.2.1 How to Connect the PTC-280NDI to a Datavideo Switcher after a 60FPS/50FPS Video Streaming (Take the HS-1300 as an example)

When you select the 50Hz or the 60Hz option from the [Video] → [Video Settings] drop-down menu in the PTC-280NDI web UI for streaming videos, the PTC-280NDI HDMI/SDI output will be fixed at 1080p 50/60. However, the Datavideo HS-1300 switcher supports the 1080i video format only rather than the 1080p video format. So, when you want to connect the PTC-280NDI to the HS-1300 switcher, it is necessary for you to set the PTC-280NDI again in order to make sure that the video formats for the PTC-280NDI and the HS-1300 are consistent. Moreover, it can assure that the input screen that is received by the HS-1300 can be displayed correctly. Please follow following steps for setting the PTC-280NDI and the HS-1300.

● **Take the adjustment to 1080i59.94 as an example**

Step 1. At first, please press the “MENU” button which is located on the PTC-280NDI remote controller to open the OSD menu.

Step 2. After the OSD menu is opened, please use the down arrow

button  to select the “Setup” option and then please press the “Home” button  to enter the “Setup” option.

Step 3. Please select the “Video Format” option, and then please use the left

arrow button and the right arrow button  /  of the remote controller to select 1080i60, 1080i59.94 or 1080i50 video format.

Step 4. Please press the “MENU” button  which is located on the control panel of the HS-1300 switcher to open its OSD menu.

Step 5. Please use the down arrow button  to select the “Setup” option.

Step 6. Please use the right arrow button to select “Standard” “1080i59.94”, and then please press the “Enter” button to enter this option for further adjustment.

Step 7. If the format for the “Standard” is not 1080i59.94, please use the up

arrow button and down arrow button  /  which are located on the control panel to adjust the video format to 1080i59.94.

Step 8. Please select your desired “Standard” value and then press the “ENTER” button again to confirm your selection.

Step 9. Please press the right arrow button  again to select the “Save Setup” option.

Step 10. Please use the left arrow button and the right arrow button to select the “Yes” button and then press the “ENTER” button again to save the setting.

Step 11. After the setting is saved, please press the “MENU” button  to exit to the previous menu and to exit the OSD menu of the HS-1300. The “Standard” option setting for the HS-1300 is finished until this step.

Step 12. Please open the web UI of the PTC-280NDI.

Step 13. Please click the “Video” option, and then please select “OSD” from the “Video Format” drop-down menu.

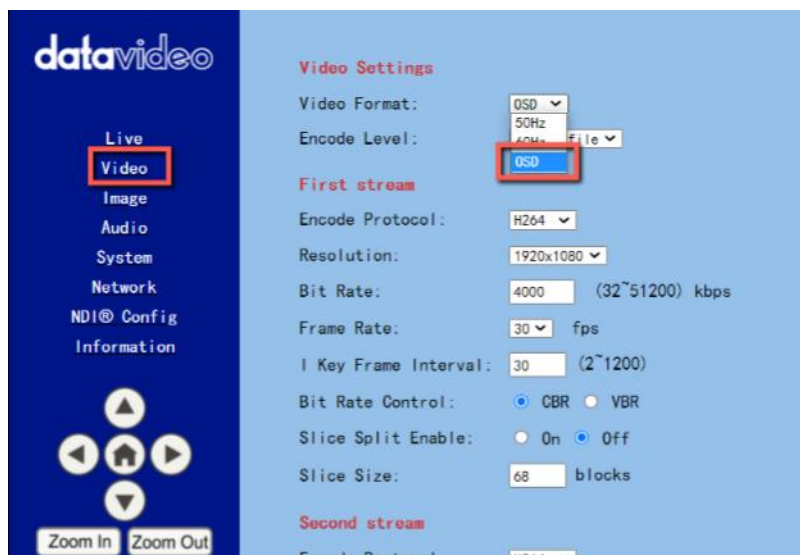

Step 14. Please click the “Apply” button .

Step 15. Please click the “Reboot” button in the “System” option to reboot the PTC-280NDI.

Step 16. After the PTC-280NDI is rebooted, please use an SDI cable to connect from the 3G-SDI interface which is located on the rear panel of the PTC-280NDI to the SDI IN interface which is located on the rear panel of the HS-

1300, or you can use an HDMI cable to connect from the HDMI interface which is located on the rear panel of the PTC-280NDI to the HDMI IN interface which is located on the rear panel of the HS-1300. After that, you can see the image which is shot by the PTC-280NDI is displayed in the MULTIVIEW window of the HS-1300 correctly.

For SDI: The SDI IN 1 to SDI IN 4 interfaces which are located on the rear panel of the HS-1300 represent the MULTIVIEW window's Input 1 to Input 4.

For HDMI: The HDMI IN 1 to HDMI IN 2 interfaces which are located on the rear panel of the HS-1300 represent the MULTIVIEW window's Input 5 to Input 6.

Note: Datavideo's SE-650, HS-1200 MU and HS-1300 switchers support 1080i video format only. So, the 1080p video format is not supported by the above-mentioned switchers. If you want to connect the PTC-280NDI camera to the SE-650 or the HS-1200 MU switcher, please remember to select the "OSD" item from "Video→ Video Format" in the PTC-280NDI web UI. Moreover, please use the OSD menu of the PTC-280NDI camera and the OSD menu of the above-mentioned switchers to adjust them in the same video standard before connecting to prevent the video format incompatible issue and the issue that the video that is shot by the PTC-280NDI can not be displayed normally in the MULTIVIEW window of the above-mentioned switchers.

8.3 Image

The “Image” option allows users to see the image that is shot by the PTC-280NDI from the preview window. Moreover, users can adjust many parameters including Brightness, Saturation, Contrast, Sharpness and Hue from this interface by using sliders. Please select “HTML5” from the drop-down menu which is located below the preview window and then users can preview the image which is shot by the PTC-280NDI from the preview window. The main interface of the Image option is shown as following diagram.

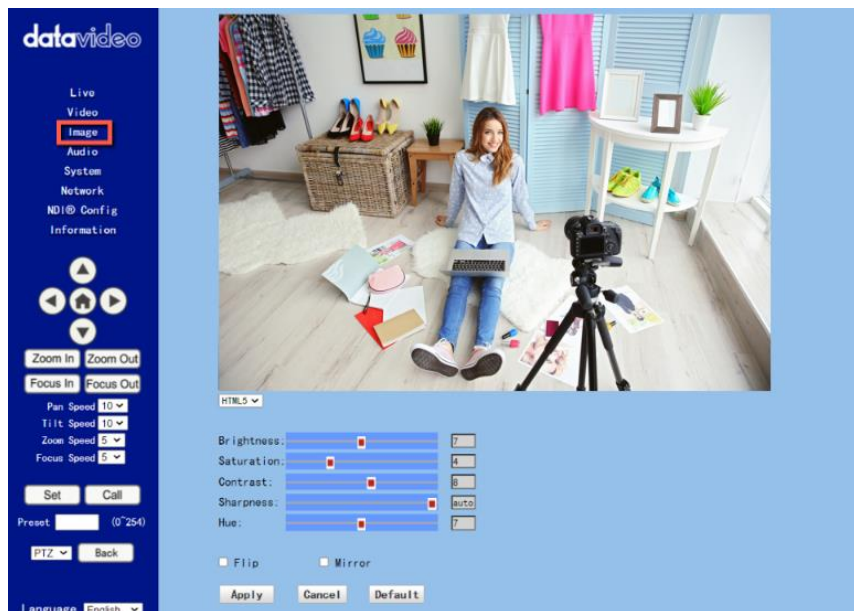

- Brightness: This option allows users to adjust the Brightness. Please use the slider for adjusting the Brightness.
- Saturation: This option allows users to adjust the Saturation. Please use the slider for adjusting the Saturation. After the adjustment is finished, please click the “Apply” button and then it is set successfully.
- Contrast: This option allows users to adjust the Contrast. Please use the slider for adjusting the Contrast. After the adjustment is finished, please click the “Apply” button and then it is set successfully.



- Sharpness: This option allows users to adjust the Sharpness. Please use the slider for adjusting the Sharpness. After the adjustment is finished, please click the “Apply” button and then it is set successfully.
- Hue: This option allows users to adjust the Hue. After the adjustment is finished, please click the “Apply” button and then it is set successfully.
- Flip: Please check the checkbox of the “Flip” option Flip and then please click the “Apply” button for flipping the image that is shot by the camera.
- Mirror: Please check the checkbox of the “Mirror” option Mirror and then please click the “Apply” button for mirroring the image that is shot by the camera.
- Default: Please click the “Default” button for restoring the settings in this page to factory default value.

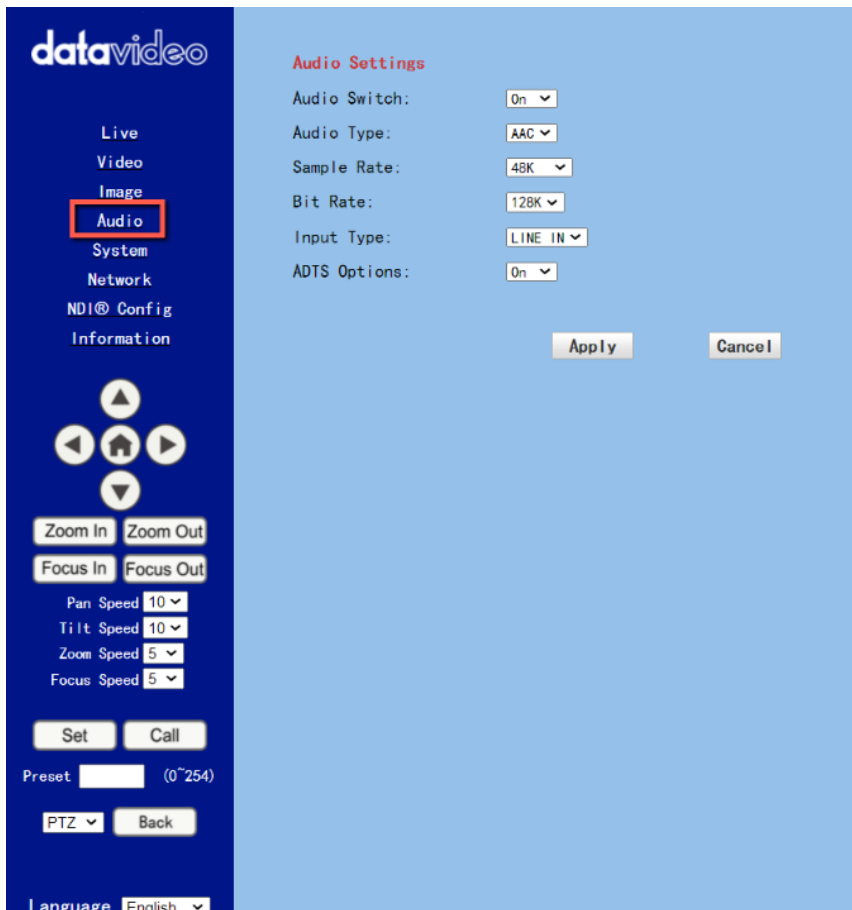

8.4 Audio

The Audio option allows users to set the audio related parameters. The main interface of the audio option is shown as following diagram.

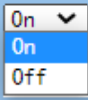

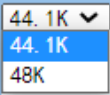
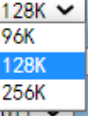
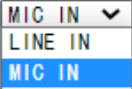
Please see following section for realizing the descriptions for each item for the Audio option.

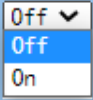
Items	Descriptions
<p>Audio Switch:</p> 	<p>Audio Switch This option allows users to turn on or turn off the input of the audio source.</p>
<p>Audio Type:</p> 	<p>Audio Type This allows users to select the encoding format of the input audio. The default audio type is the AAC format.</p>
<p>Sample Rate:</p> 	<p>Sample Rate This drop-down menu allows users to select desired sample rate for the input audio source. There are two sample rate including 44.1K and 48K for users to select.</p>
<p>Bit Rate:</p> 	<p>Bit Rate This drop-down menu allows users to select their desired Bit Rate.</p>
<p>Input Type:</p> 	<p>Input Type This option allows users to select the audio signal input way. Users can input the audio by external connected MIC or by LINE IN.</p>

Items	Descriptions
<p data-bbox="137 145 331 172">ADTS Options:</p> 	<p data-bbox="624 140 770 167">ADTS Option</p> <p data-bbox="624 172 964 260">This drop-down menu allows users to turn on or turn off the ADTS.</p> <p data-bbox="624 268 983 1046">ADTS is the abbreviation of the “Audio Data Transport Stream”. The ADTS is a common transmission format of the AAC audio file. Sometimes, you will encounter an issue that your AAC file which is written can not be played by the PC or mobile phone when you are doing the AAC original stream coding. The possible reason for this issue is that it does not have ADTS Header package for each frame of the AAC file. What you have to do is to add an ADTS Header. The original data block length is variable for an AAC file. When you add an ADTS Header for the original frame and then wrap it up in ADTS package, it will become an ADTS frame. Each frame of the AAC audio file includes an ADTS Header and AAC Audio Data.</p>
	<p data-bbox="624 1090 740 1117">Apply Key</p> <p data-bbox="624 1121 977 1241">After all of the options are set, please click the “Apply” key and then all of the changes will be effective.</p>

Items	Descriptions
<div style="border: 1px solid black; padding: 5px; display: inline-block;">Cancel</div>	<p>Cancel Key If the “Cancel” key is pressed, all of the changes will not take effect.</p>

8.5 System

This System option allows users to select functions including Work Mode, Reboot, User Name and Password. The main interface of the System option is shown as following diagram.

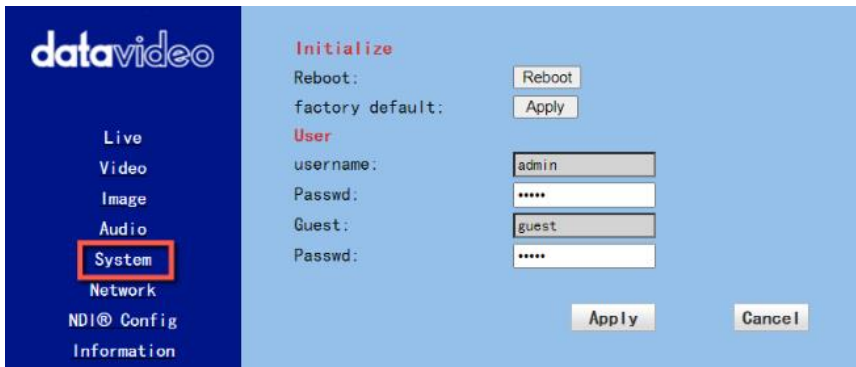

Please see following section for realizing the descriptions for each item for the System option.

Items	Descriptions
<div style="border: 1px solid black; padding: 5px; display: inline-block;">Reboot: <div style="border: 1px solid black; padding: 2px 5px;">Reboot</div></div>	<p>Reboot Please press this button for rebooting the PTC-280NDI camera.</p>

Items	Descriptions
<p>factory default: <input type="button" value="Apply"/></p>	<p>Factory Default Please press this button to reset the PTC-280 to its factory default value.</p>
<p>User</p> <p>username: <input type="text" value="admin"/></p> <p>Passwd: <input type="password" value="....."/></p> <p>Guest: <input type="text" value="guest"/></p> <p>Passwd: <input type="password" value="....."/></p>	<p>User</p> <p>There are several items including Username, Password, Guest and Password for users to set the username and password for user and guest. After the setting is finished, please press the “Apply” button for applying the setting.</p> <p>The default username/Password for user is “admin/admin”.</p> <p>The default Username/Password for Guest is “guest/guest”.</p>
<p><input type="button" value="Apply"/></p>	<p>Apply Key After all of the options are set, please click the “Apply” key and then all of the changes will be effective.</p>
<p><input type="button" value="Cancel"/></p>	<p>Cancel Key If the “Cancel” key is pressed, all of the changes will not take effect.</p>

8.6 Network

The Network option allows users to set many network related functions. The main interface of the Network option is shown as following diagram.

data video

Live
Video
Image
Audio
System
Network
NDI® Config
Information

Zoom In Zoom Out
Focus In Focus Out

Pan Speed 10
Tilt Speed 10
Zoom Speed 5
Focus Speed 5

Set Call
Preset (0~254)
PTZ Back

Language English

Lan Settings

IP Configuration Type: Fixed IP Address

IP Address: 192.168.50.30

Subnet Mask: 255.255.255.0

Gateway: 192.168.50.1

DNS Address: 192.168.50.1

MAC Address: 00 : 07 : 34 : 08 : 40 : 13

Apply Cancel

Port Settings

HTTP Port number: 80 (80)

RTSP Port: 554 (554)

PTZ Port: 5678 (5678)

UDP Port: 1259 (1259)

Sony Vieca: 52381

SRT Settings

SRT: On Off

SRT Port: 9000

SRT Encry: Off

SRT Password: 1234567890 (SRT Password length greater than 9 bits)

Control Protocol Settings

Pelco-D Address: 3 (0~254)

Pelco-P Address: 1 (0~31)

RTMP(S) Settings

First stream: On Off Video Audio

MRL: rtmps://live-api-s.facebook.com:443/rtmp/FB-1020897382949564-0-Abw4Uo-fRhn78uA0

Second stream: On Off Video Audio

MRL:

RTSP Settings

RTSP Auth: On Off

ONVIF Settings

ONVIF: On Off

ONVIF Auth: On Off

Multicast Settings

Multicast: On Off

Address: 224.1.2.3

Port: 6688

SDK Settings

Active Connection: On Off

Address: 192.168.100.138

Port: 1234

NTP Settings

time zone: (GMT+08:00): Beijing Chongqing Hong Kong Urumqi

NTP time sync: On Off

Server address: time.google.com

Time interval: 1440 minutes

Main time show: On Off

Position: X 50 Y 50 (0~100)

Sub time show: On Off

Position: X 30 Y 30 (0~100)



Apply Cancel

Please see following section for realizing the descriptions for each item for the Network option.

Items	Descriptions
<p>Lan Settings</p> <p>IP Configuration Type: <input type="text" value="Fixed IP Address"/> <input type="text" value="Fixed IP Address"/> <input type="text" value="Dynamic IP Address"/></p> <p>IP Address:</p>	<p>IP Configuration Type</p> <p>This drop-down menu allows users to select the Static IP or DHCP mode. If the “Fixed IP Address” is selected, it will operate in static IP mode. If the “Dynamic IP Address” is selected, it will operate in DHCP mode.</p>
<p>IP Address: <input type="text" value="192.168.2.100"/></p> <p>Subnet Mask: <input type="text" value="255.255.255.0"/></p> <p>Gateway: <input type="text" value="192.168.2.1"/></p> <p>DNS Address: <input type="text" value="192.168.2.1"/></p>	<p>IP Address/Subnet Mask/Gateway/DNS Address</p> <p>If the fixed IP address is selected, users can set related parameters manually. After the settings are finished, please click the “Apply” button and then those settings will take effect.</p>
<p>MAC Address: <input type="text" value="D4 : E0 : BE : AB : 18 : 06"/></p>	<p>MAC Address</p> <p>This is the MAC Address and it can not be changed by users.</p>
<p>HTTP Port number: <input type="text" value="80"/> (80)</p>	<p>HTTP Port</p> <p>This is the HTTP Port and the default port No. is 80.</p>

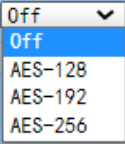
Items	Descriptions
RTSP Port: <input type="text" value="554"/> (554)	RTSP Port This is the RTSP Port and the default port No. is 554.
PTZ Port: <input type="text" value="5678"/> (5678)	PTZ Port This is the PTZ Port No. and the default port No. is 5678.
UDP Port: <input type="text" value="1259"/> (1259)	UDP Port This is the UDP Port No. and the default port No. is 1259.
Sony Visca: <input type="text" value="52381"/>	Sony Visca This is the Sony Visca Port No. and the default No. is 52381.
SRT: <input type="radio"/> On <input checked="" type="radio"/> Off	SRT On/Off This allows users to turn on or turn off the SRT streaming function.
SRT Port: <input type="text" value="4578"/>	SRT Port This is the SRT port and the default port No. is 4578.

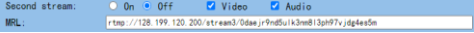
Items	Descriptions
<p>SRT Encry: </p>	<p>SRT Encry When the SRT function is turned on, this option allows users to select their desired SRT Encryption way. There are three encryption ways including AES-128, AES-192 and AES-256 for users to select.</p>
<p>SRT Password: <input type="text" value="1234567891"/> (SRT Password length greater than 9 bits)</p>	<p>SRT Password When the SRT encryption way is set, it is needed for users to use this password. The default value is 1234567891 and this password can change by users.</p>
<p>Pelco-D Address: <input type="text" value="0"/> (0~254)</p>	<p>Pelco-D Address This option allows users to set the Pelco-D address, the range is from 0 to 254.</p>
<p>Pelco-P Address: <input type="text" value="0"/> (0~31)</p>	<p>Pelco-P Address This option allows users to set the Pelco-P Address, the range is from 0 to 31.</p>
<p>RTMP(S) Settings First stream: <input type="checkbox"/> On <input checked="" type="checkbox"/> Off <input checked="" type="checkbox"/> Video <input checked="" type="checkbox"/> Audio MRL: <input type="text" value="rtsp://a.rtmp.youtube.com/live2/gfay-3jva-70aw-tr_j8-6gr"/></p>	<p>First Stream This option allows users to determine whether they want to turn on/turn off the First Stream streaming. Moreover, this option can turn on/turn off the streaming of video and audio separately.</p> <p>MRL Please copy the RTMP server address and streaming key</p>

Items	Descriptions
	<p>from the streaming platform and then paste them into this MRL column. After that, please press the “Apply” button for starting the streaming successfully.</p>
	<p>Second Stream</p> <p>This option allows users to determine whether they want to turn on/turn off the Second Stream streaming. Moreover, this option can turn on/turn off the streaming of video and audio separately.</p> <p>MRL</p> <p>Please copy the RTMP server address and streaming key from the streaming platform and then paste them into this MRL column. After that, please press the “Apply” button for starting the streaming successfully.</p>
	<p>RTSP Auth</p> <p>This option allows users to turn on or turn off the authentication of the RTSP streaming.</p>
	<p>ONVIF</p> <p>This option allows users to turn on or turn off the ONVIF function.</p>

Items	Descriptions
ONVIF Auth: <input type="radio"/> On <input checked="" type="radio"/> Off	ONVIF Auth This option allows users to turn on or turn off the ONVIF authentication.
Multicast: <input type="radio"/> On <input checked="" type="radio"/> Off	Multicast This option allows users to turn on or turn off the Multicast function.
Address: <input type="text" value="224.1.2.3"/>	Address This option is the address of Multicast. The default value is 224.1.2.3
Port: <input type="text" value="1234"/>	Port This is the Port No. of the Multicast. The default No. is 1234.
SDK Settings Active Connection: <input type="radio"/> On <input checked="" type="radio"/> Off	SDK Settings This allows users to turn on or turn off the Active Connection of the SDK Settings.
Address: <input type="text" value="192.168.100.138"/> Port: <input type="text" value="6688"/>	Address/Port This is the Address and Port of the SDK Settings. The Address is 192.168.100.138. The Port No. is 6688.

Items	Descriptions
	<p>Time Zone</p> <p>This option allows users to select their time zone.</p>
<p>NTP time sync: <input checked="" type="radio"/> On <input type="radio"/> Off</p>	<p>NTP Time Sync</p> <p>This option allows users to turn on or turn off the NTP Time Sync function.</p>
<p>Server address: <input type="text" value="cn.ntp.org.cn"/></p>	<p>Server Address</p> <p>This option allows users to enter their desired NTP server.</p>
<p>Time interval: <input type="text" value="1440"/> minutes</p>	<p>Time Interval</p> <p>This option allows users to set the time interval for the time calibration.</p>
<p>Main time show: <input checked="" type="radio"/> On <input type="radio"/> Off</p> <p>Position: X <input type="text" value="0"/> Y <input type="text" value="0"/> (0~100)</p>	<p>Main Time Show/Position</p> <p>This option allows users to open or close the time display function for the main time. Moreover, users can enter different X coordinate and Y coordinate positions to determine the position for showing the time on the screen. (The allowable setting range is from 0 to 100).</p>
<p>Sub time show: <input type="radio"/> On <input checked="" type="radio"/> Off</p> <p>Position: X <input type="text" value="0"/> Y <input type="text" value="0"/> (0~100)</p>	<p>Sub Time Show/Position</p> <p>This option allows users to open or close the time display function for the sub time. Moreover, users can enter different X coordinate and Y</p>

Items	Descriptions
	<p>coordinate positions to determine the position for showing the time on the screen. (The allowable setting range is from 0 to 100).</p>
<p>Apply</p>	<p>Apply Key After all of the options are set, please click the “Apply” key and then all of the changes will be effective.</p>
<p>Cancel</p>	<p>Cancel Key If the “Cancel” key is pressed, all of the changes will not take effect.</p>

8.7 NDI® Config

This NDI® Config option provides “Device Name”, “Group Name” and “NDI® Firmware Version” for your reference. The main interface of the “NDI®Config” option is shown in the following diagram.

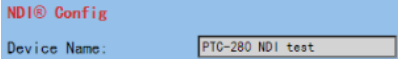

Please see following section for realizing the descriptions for each item for the NDI®Config option.

Items	Descriptions
	<p>Device Name</p> <p>This device name option will show the name of your PTC-280NDI camera when it is connected and is detected by the NDI Tools software “NDI Studio Monitor”. This “Device Name” column does not allow you to modify the device name. If you want to modify the device name, please click the “Information” option for entering your desired device name in the “Device ID” column.</p>

Items	Descriptions
<p>Group Name: <input type="text" value="public"/></p>	<p>Group Name This option will show the “NDI Group Name” of your PTC-280NDI camera. The default NDI Group Name is “Public”. For NDI, the transferring and receiving devices must be set in the same group name. Generally speaking, the group name is set by using the NDI Access Manager software. The NDI group can control the visibility and access between each group.</p>
<p>NDI® Firmware Version: <input type="text" value="DV4. 6. 1"/></p>	<p>NDI® Firmware Version This column will show current firmware version of your PTC-280NDI camera.</p>

8.8 Information

In the “Information” option, users can change the device name by themselves. Moreover, users can also see the messages including software version, device model and web UI version. The main interface of the Information option is shown as following diagram.

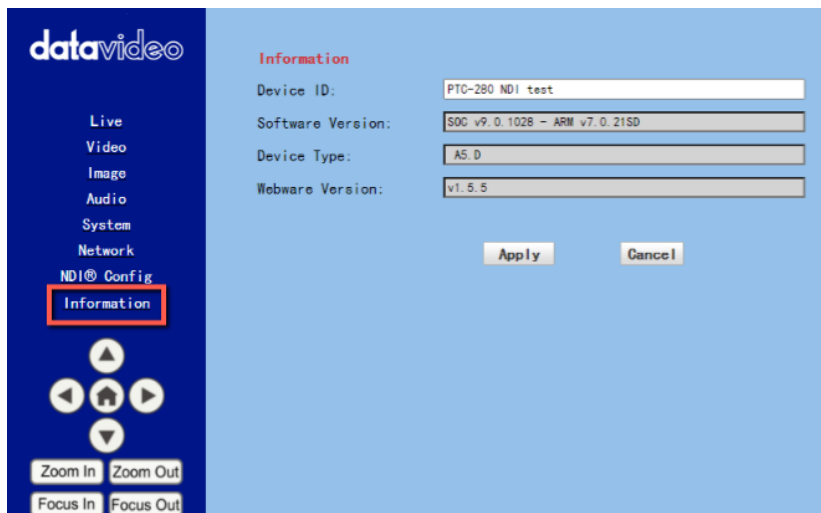

Please see following section for realizing the descriptions for each item for the information option.



Items	Descriptions
Device ID: <input type="text" value="HD Camera"/>	<p>Device ID</p> <p>This column allows users to determine the device ID by themselves. What they have to do is to enter their desired device ID and then click the “Apply” button.</p>

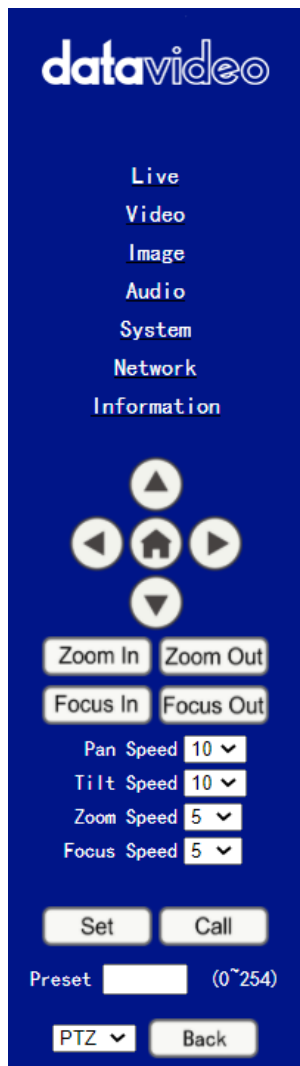

Items	Descriptions
Software Version: <input type="text" value="SOC v9.0.850 - ARM v7.0.12SD"/>	Software Version This option can show current software version.
Device Type: <input type="text" value="A5.D"/>	Device Type This can show device type.
Webware Version: <input type="text" value="v1.5.5"/>	Webware Version This is the version of the web-based control UI.
<input type="button" value="Apply"/>	Apply Key After all of the options are set, please click the “Apply” key and then all of the changes will be effective.
<input type="button" value="Cancel"/>	Cancel Key If the “Cancel” key is pressed, all of the changes will not take effect.

8.9 The PTZ Control Area of the Web UI

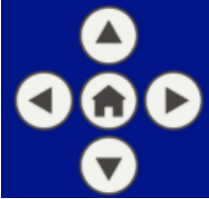
PTC-280NDI camera's PTZ control area in the Web UI allows users to control the directions, Zoom-In, Zoom-Out, Focus Near and Focus Far parameters for the PTZ camera lens. Moreover, users can also adjust the panning, tilting speed, preset setting and preset calling functions. The PTZ control area is shown as following diagram.

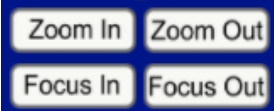
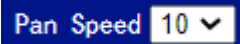
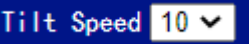

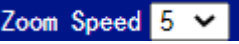
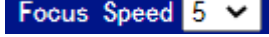
Items	Descriptions
	<p>UP/Down/Left/Right/Home Keys Users can click the up, down, left and right keys and the PTZ camera lens will rotate to assigned direction. If the Home key  is pressed twice, the camera lens will return back to the initial position automatically. If this Home key is used with the “Back” key, when the “OSD” is selected and the Back key is clicked, the OSD menu will be shown on the external connected screen and users can use the up, down, left and right keys on the Web UI to control the camera.</p>
	<p>Zoom In/Zoom Out/Focus In/Focus Out Click “Zoom In” or “Zoom Out” for zooming in or zooming out the camera lens. Click the “Focus In” or “Focus Out” for Focusing Near or Focusing Far the camera lens.</p>
	<p>Pan Speed The “Pan Speed” allows users to adjust the rotation speed of the PTZ camera lens. The allowable setting range is from 1 to 24. The larger the number, the faster the PTZ camera lens will rotate.</p>
	<p>Tilt Speed The “Tilt Speed” allows users to adjust the vertical rotation speed of the camera lens. The allowable setting range is from 1 to 20. The larger the number, the faster the PTZ camera lens will rotate.</p>

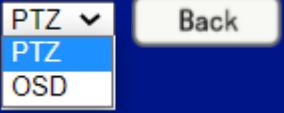
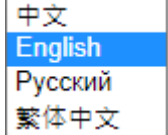
Items	Descriptions
	<p>Zoom Speed</p> <p>The “Zoom Speed” allows users to adjust the Zoom In/Zoom Out speed of the PTZ camera lens. The allowable setting range is from 0 to 7. The larger the number, the faster the PTZ camera lens will rotate.</p>
	<p>Focus Speed</p> <p>The “Focus Speed” allows users to adjust the “Focus Near” and “Focus Far” speed of the PTZ camera lens. The allowable setting range is from 0 to 7. The larger the number, the faster the PTZ camera lens will rotate.</p>
	<p>Set and Call Presets</p> <p>The PTC-280NDI provides 255 presets (0-254) for users to set. Users can use “Set” button to set the preset position and users can use the “Call” button to recall the pre-saved presets.</p>
	<p>OSD/PTZ Drop-Down Menu</p> <p>Press the OSD option from the web UI allows camera to call the OSD menu immediately. If the PTZ is selected after the OSD menu is shown, the OSD menu will disappear and the screen will go back to the scene that is shot by the camera.</p>
	<p>Language Drop-Down Menu</p> <p>Users can use this drop-down menu for selecting four different languages including Traditional Chinese, русский, English and Simplified Chinese.</p>

9. How to Use the Web UI to Set and Call Presets

Please follow following steps for setting and recalling the presets.

● How to Set Preset

1. Please adjust your desired camera parameters and camera lens positions in advance.

2. Please enter your desired preset number in the “Preset”

column (0~254).

3. Please click the “Set” button and then the preset is set successfully.

● How to Recall Preset

1. Please enter the preset number that you want to recall into the “Preset”

(0~254) column.

2. Please click the “Call” button and then the preset is recalled successfully.

10. DIP Switch Settings

10.1 DIP Switch SW1

The DIP Switch SW1 can be found at the bottom of the camera, where the user is allowed to set the camera's VISCA ID, enable remote control, select the video resolution, and configure how the video mode can be selected.

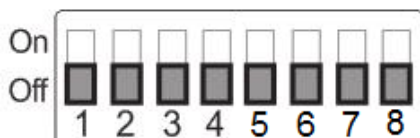

DIP SW 1/2/3	VISCA ID
(1,2,3) = (ON,OFF,OFF)	VISCA-ID 1
(1,2,3) = (OFF,ON ,OFF)	VISCA-ID 2
(1,2,3) = (ON ,ON ,OFF)	VISCA-ID 3
(1,2,3) = (OFF,OFF,ON)	VISCA-ID 4
(1,2,3) = (ON ,OFF,ON)	VISCA-ID 5
(1,2,3) = (OFF,ON ,ON)	VISCA-ID 6
(1,2,3) = (ON ,ON ,ON)	VISCA-ID 7
DIP SW 4	Remote Control Protocol
ON	DVIP
OFF	RS-422
DIP SW 5/6/7	Resolution
(5,6,7) = (OFF,OFF,OFF)	1920 x 1080i 59.94
(5,6,7) = (ON,OFF,OFF)	1920x1080i50
(5,6,7) = (OFF,ON,OFF)	1920 x 1080p 59.94
(5,6,7) = (ON,ON,OFF)	1920 x 1080p 50
(5,6,7) = (OFF,OFF,ON)	3840 x 2160p 29.97
(5,6,7) = (ON,OFF,ON)	3840 x 2160p 25
(5,6,7) = (OFF,ON,ON)	3840 x 2160p 59.94
(5,6,7) = (ON,ON,ON)	3840 x 2160p 50
DIP SW 8	Video Mode Selection Method
ON	Video mode selectable by DIP switch only
OFF	Video mode selectable by menu

10.2 DIP Switch SW2 (IRID)

The IRID DIP Switch can be found on the rear panel of the PTC-280NDI camera. This DIP switch allows the user to assign an ID number to the camera so that the user can navigate between the cameras by pressing the **CAMERA SELECT** buttons.

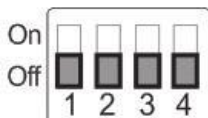

DIP SW 1/2	Camera Select Function (IR Remote Control) – Camera ID Assignment
(1,2) = (OFF,OFF)	CAM1 (IR)
(1,2) = (ON,OFF)	CAM2 (IR)
(1,2) = (OFF,ON)	CAM3 (IR)
(1,2) = (ON,ON)	CAM4 (IR)
* DIP SW 3/4 should be always OFF.	

11. How to Play the RTSP Stream by the VLC Player

Please follow following steps for playing the RTSP streaming by using the VLC Player.

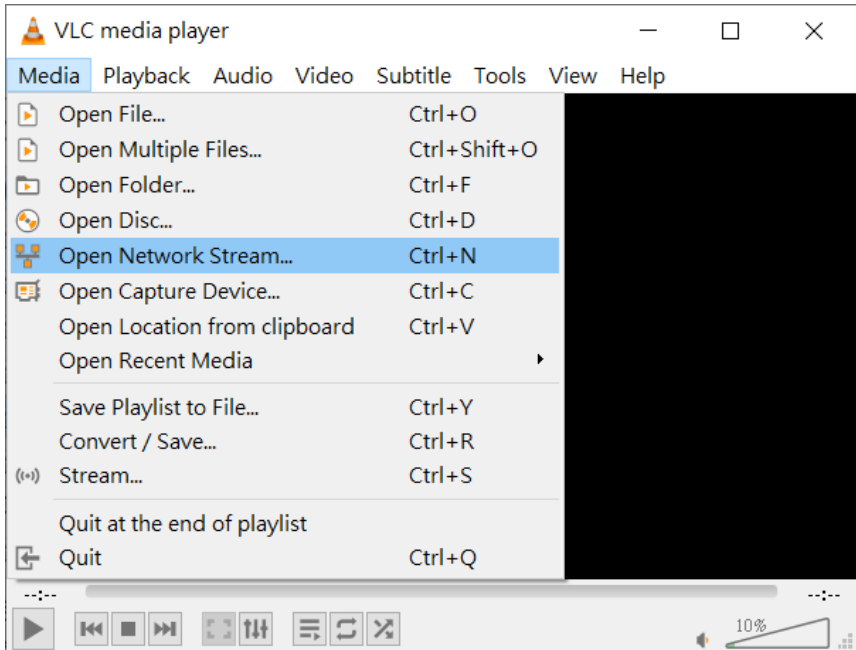

1. Please open the VLC Player.
2. Please click “Media-> Open Network Stream”.
3. Please enter the RTSP address.

rtsp://ip address: port No./1 (first stream).

rtsp://ip address: port No./2 (second stream).

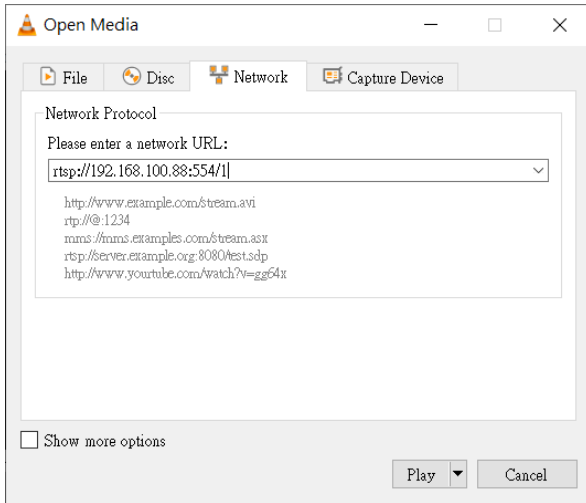

4. Please click “Play” button.

Note: The default port No. of the RTSP is 554, if the default http port of the camera is 80, it is no need for users to enter the port No.

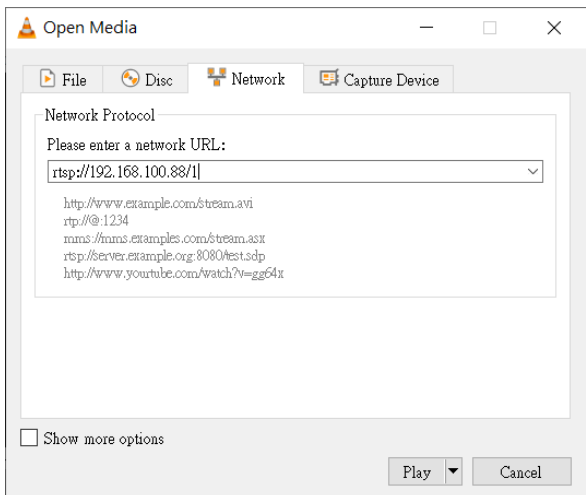

12. How to Play the Multicast by the VCL Player

The RTP Multicast allows users to view the camera image remotely by specific video player such as the VLC Player.

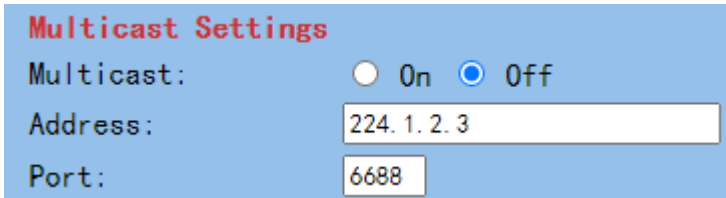

The image shows a dialog box titled "Multicast Settings" with a blue background. It contains three fields: "Multicast:" with radio buttons for "On" and "Off" (the "Off" button is selected), "Address:" with a text input field containing "224. 1. 2. 3", and "Port:" with a text input field containing "6688".

Please follow following steps for playing the RTP Multicast in the VLC Player.

1. Download VLC media player from the link <https://www.videolan.org>.
2. Open VLC, click “Media” → “Open Network Stream” then enter **rtp://224.1.2.3:6688** to view the first stream and **rtp://224.1.2.3:6690** to view the second stream.

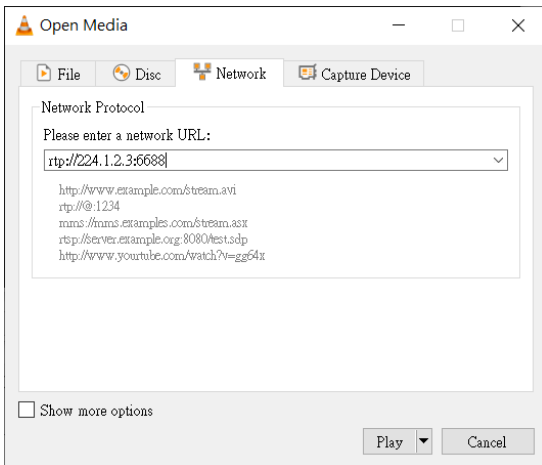

3. Click the “Play” button to start viewing the video stream.

13. How to Stream to Facebook

Please follow following steps for streaming to Facebook Streaming platform.

- **Use Facebook Live Producer for Streaming**

1. Please go to Facebook Live website

<https://www.facebook.com/formedia/solutions/facebook-live> , and then please click “Go Live Now” button which is shown in the following diagram.

Note: Facebook Live limits each stream to 8 hours.

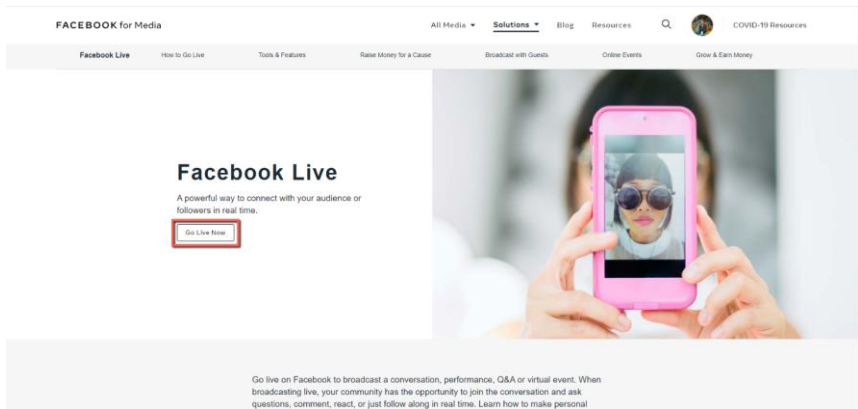

2. Please click the “Select” button from the “Go live” option which is shown in the following diagram.

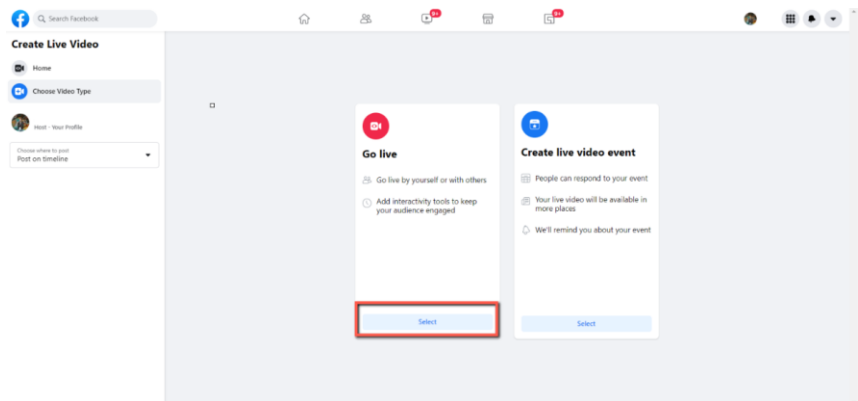

3. Please select the “Streaming Software” option, and then please enter the title and description of your live-streaming video in the “Title” and “Description” columns. Moreover, you can determine whether you want to share your live-streaming video to your Facebook Story.

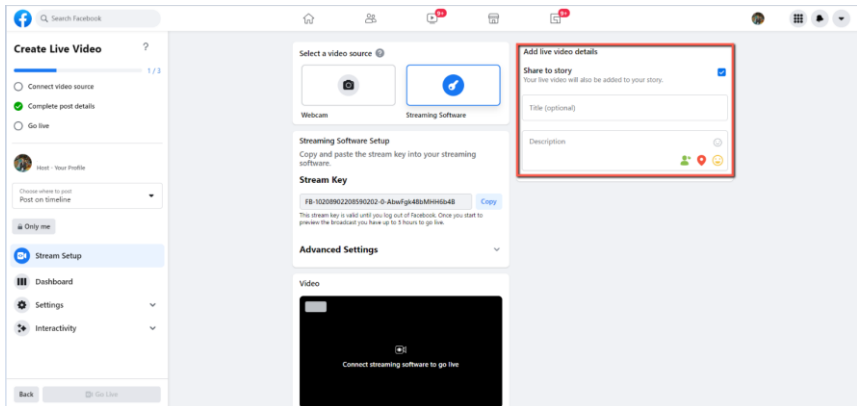

4. Please select “Advanced Settings”, and then you can see the “Server URL”. You need the “Server URL” and the “Stream Key” which are on the page for live-streaming videos on the Facebook page.

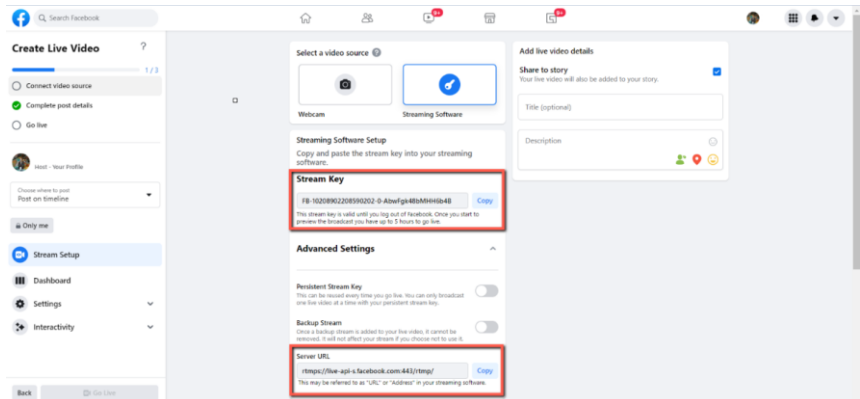

5. Please click the “Copy” buttons which are located next to the “Server URL” and “Stream Key” columns respectively. After that, please paste them to the “First Stream MRL” column in the “Network” option of the PTC-280NDI web UI. Please follow the following format to paste the “Server URL” and “Stream Key” into the PTC-280NDI web UI.

➤ Server URL/Stream Key

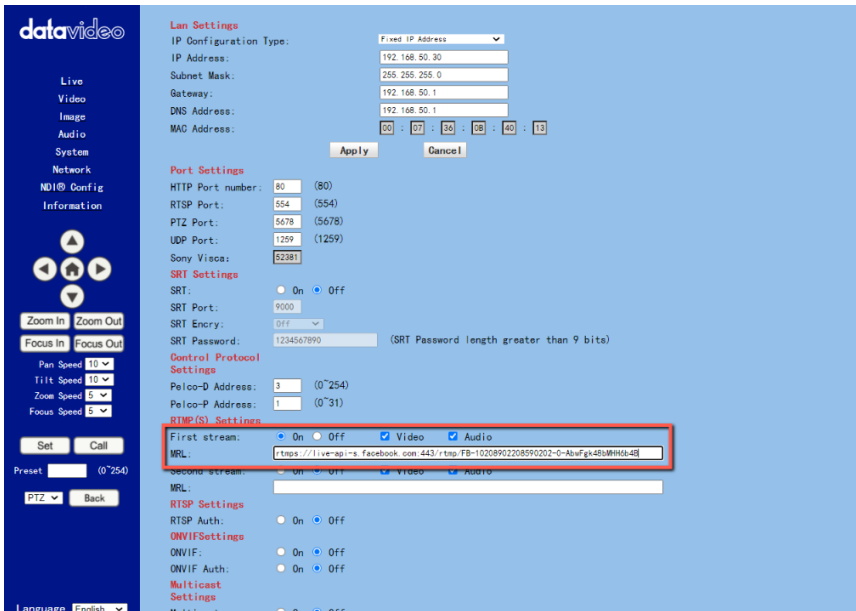
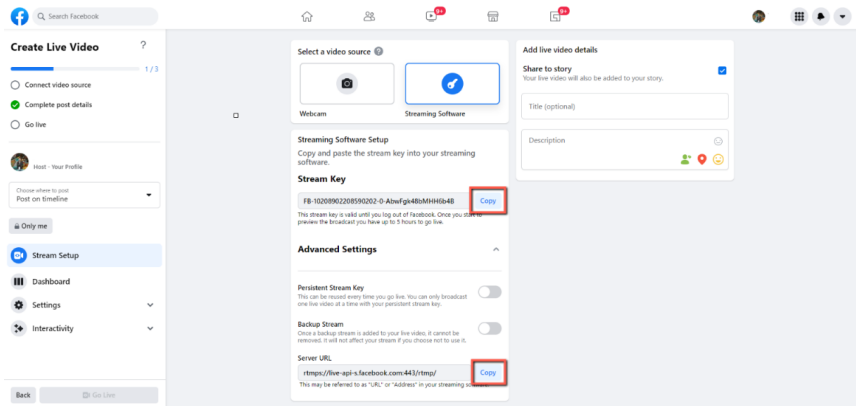

Note: Please make sure that the “ON” is selected for the First Stream MRL . Moreover, please make sure that the “Video” and “Audio” checkboxes are checked.

6. Please click the “Apply” button .

7. Please click the “Reboot” button in the “System” option to reboot the PTC-280NDI.

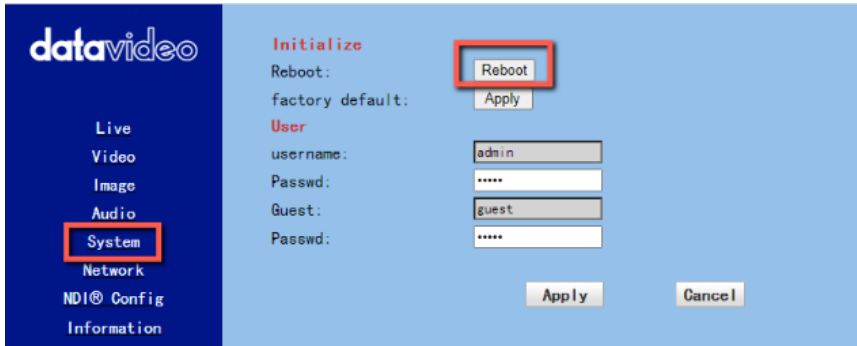

192.168.50.30

the ipcam will be rebooted. Are you sure?



8. After the PTC-280NDI is rebooted, you can see the real-time preview which is shot by the PTC-280NDI camera from the “Video” option of the Facebook Live page.

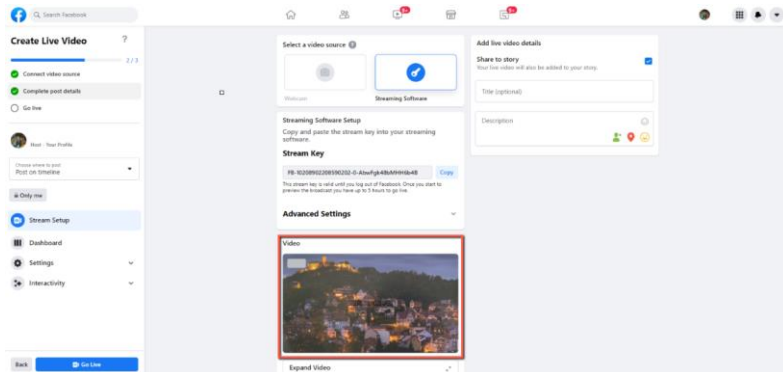

9. Please set related settings including “Choose where to post” and “Select audience”. After that, please press the “Go Live” button for live-streaming the real-time image which is shot by the PTC-280NDI immediately.

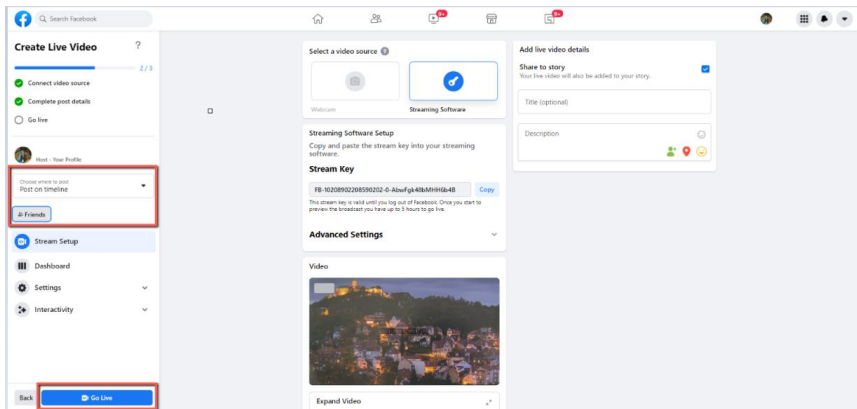
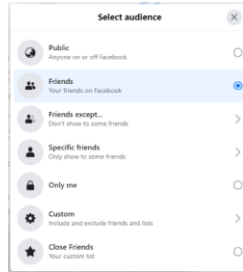
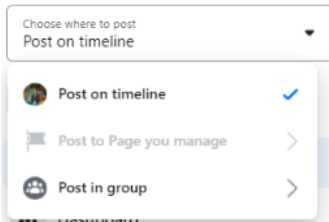

10. And then you can see that the live-streaming is done successfully. If you want to stop the live-streaming, please click the “End Live Video” button for stopping the live-streaming immediately.

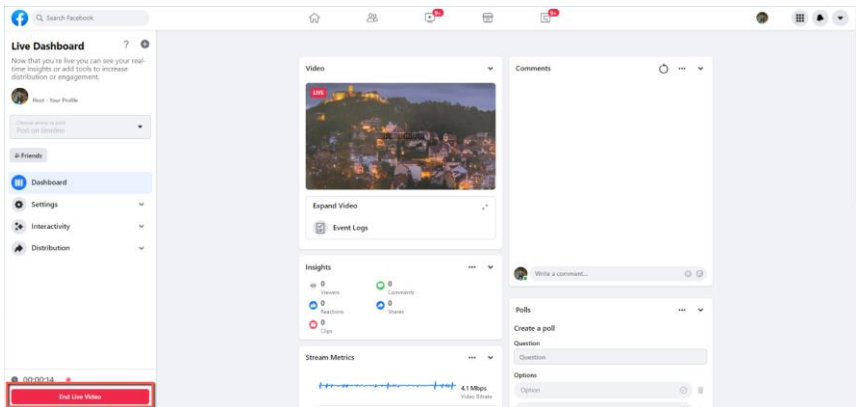

- **Use the Personal Facebook Page or the Facebook Fan Page for Streaming**

1. Please click “Live Video” from your Facebook Personal Page or Facebook Fan Page.

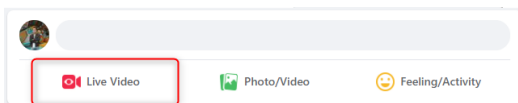

2. Please click the “Select” button from the “Go live” option which is shown in the following diagram.

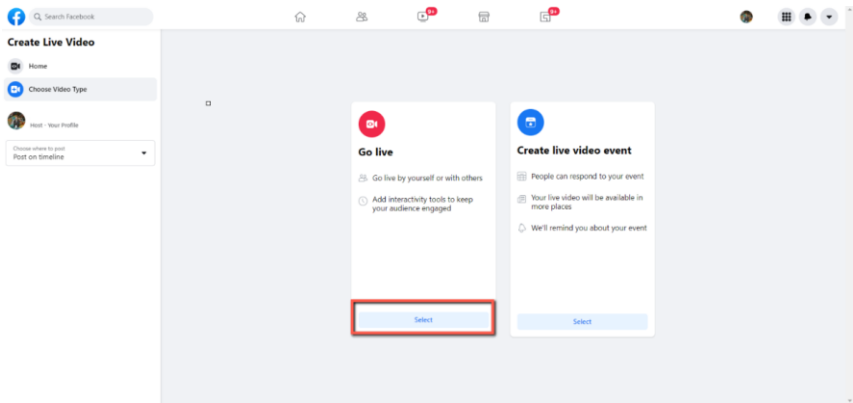

3. Please select the “Streaming Software” option, and then please enter the title and description of your live-streaming video in the “Title” and “Description” columns. Moreover, you can determine whether you want to share your live-streaming video to your Facebook Story.

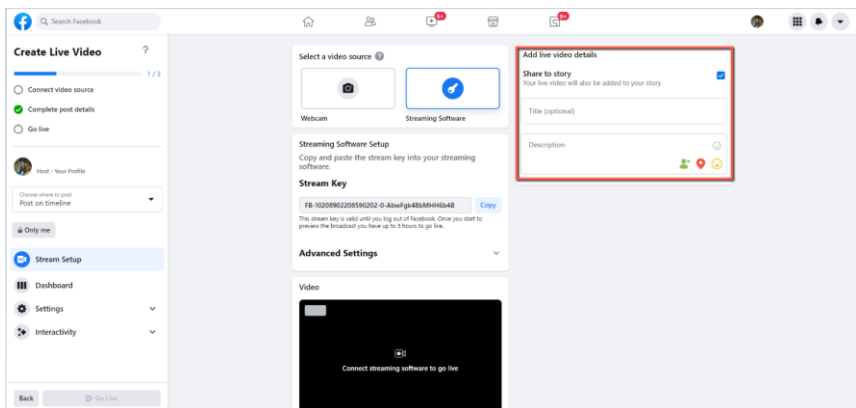

4. Please select “Advanced Settings”, and then you can see the “Server URL”. You need the “Server URL” and the “Stream Key” which are on the page for live-streaming videos on the Facebook page.

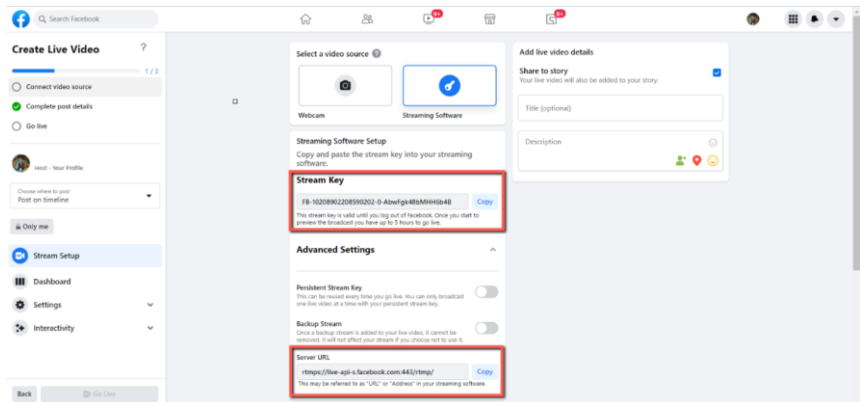

5. Please click the “Copy” buttons which are located next to the “Server URL” and “Stream Key” columns respectively. After that, please paste them to the “First Stream MRL” column in the “Network” option of the PTC-280NDI web UI. Please follow the following format to paste the “Server URL” and “Stream Key” into the PTC-280NDI web UI.

➤ Server URL/Stream Key

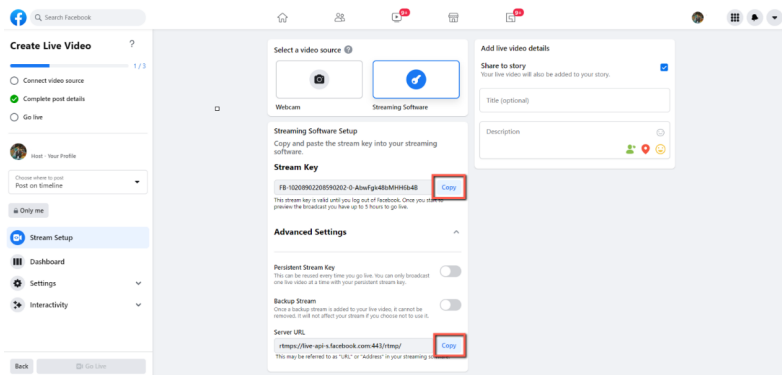

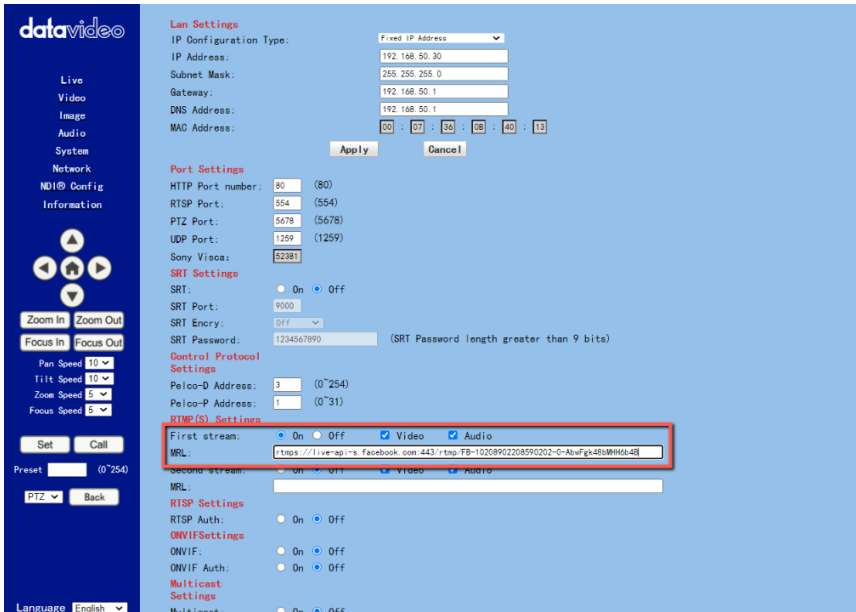

Note: Please make sure that the “ON” is selected for the First Stream MRL . Moreover, please make sure that the ”Video” and ”Audio” checkboxes are checked.

6. Please click the “Apply” button .

7. Please click the “Reboot” button in the “System” option to reboot the PTC-280NDI.

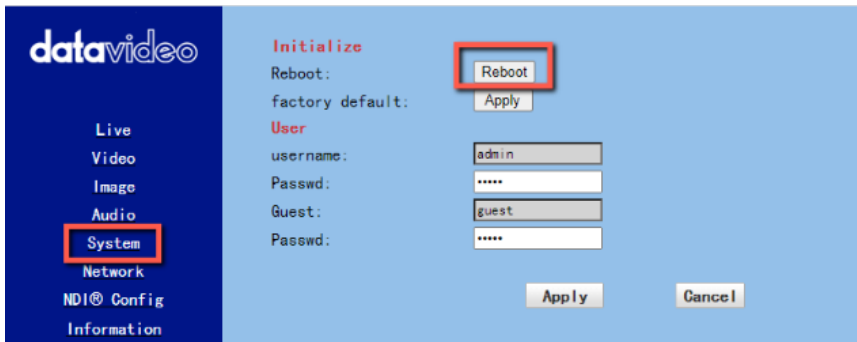

192.168.50.30

the ipcam will be rebooted. Are you sure?



8. After the PTC-280NDI is rebooted, you can see the real-time preview which is shot by the PTC-280NDI camera from the “Video” option of the Facebook Live page.

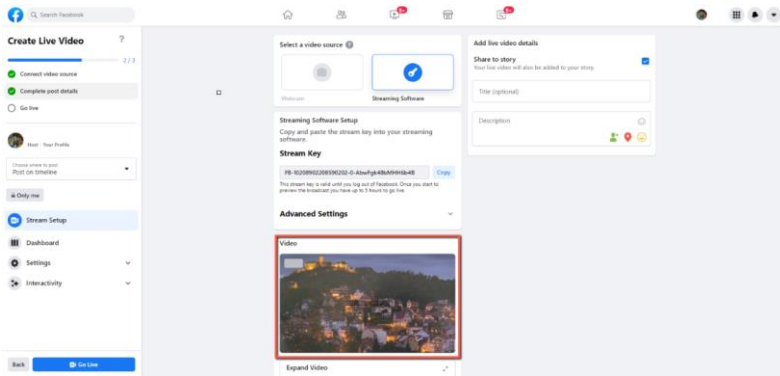

9. Please set related settings including “Choose where to post” and “Select audience”. After that, please press the “Go Live” button for live-streaming the real-time image which is shot by the PTC-280NDI immediately.

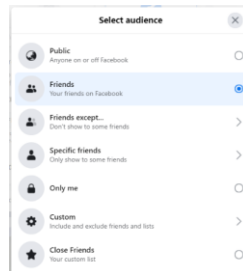
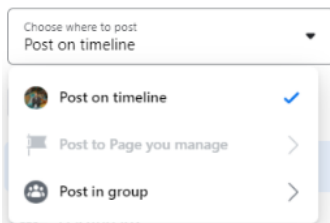

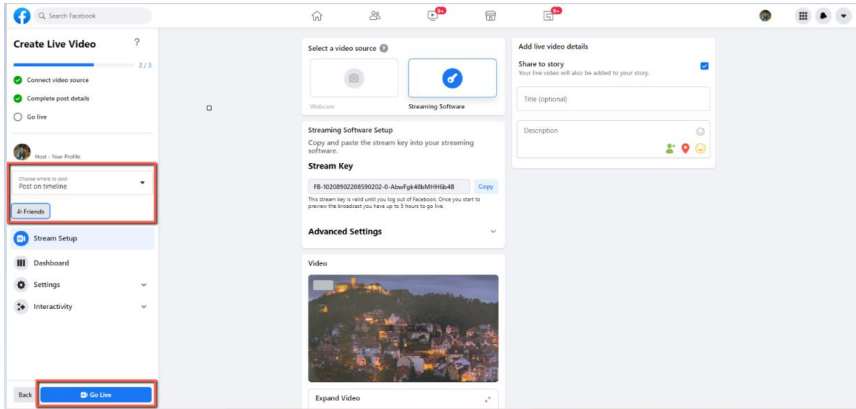

10. And then you can see that the live-streaming is done successfully. If you want to stop the live-streaming, please click the “End Live Video” button for stopping the live-streaming immediately.

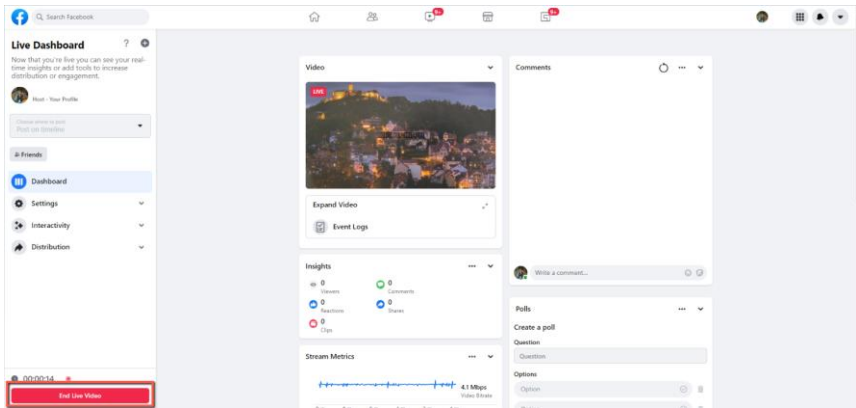

14. How to Stream to Youtube

Please see following steps for realizing how to stream to Youtube streaming platform.

1. Please go to Youtube website www.youtube.com and then click “Create->Go Live”.

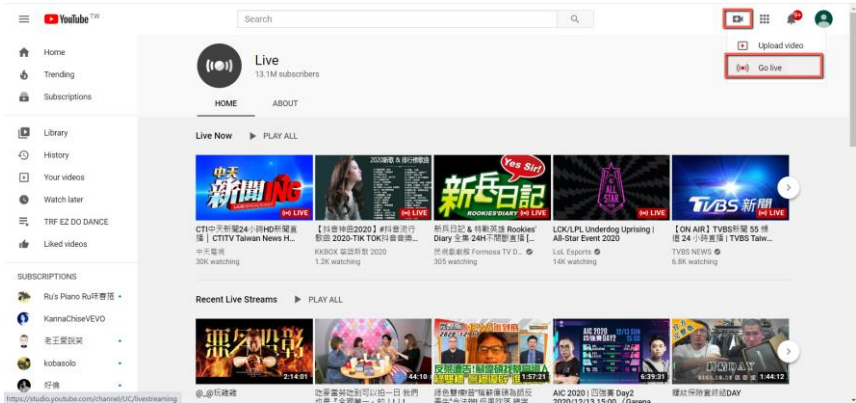

2. Users will enter “Youtube Live Control Room” page, please click the “START” button from the “Right Now” option.

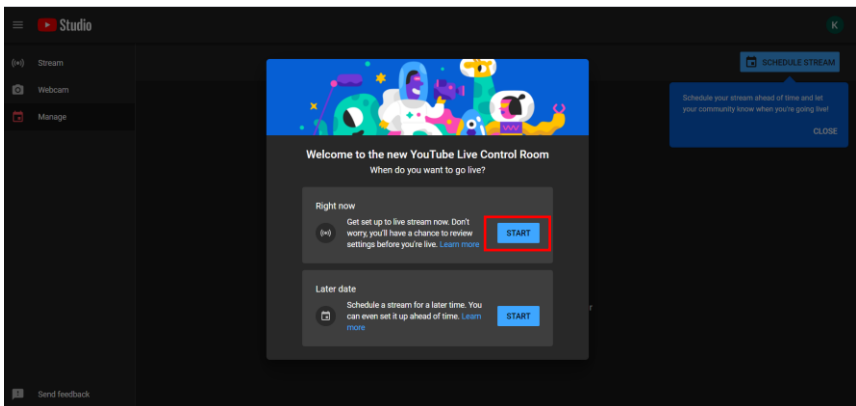

3. Please click **“Go”** button from the **“Streaming Software”** option.

4. Users will see the main page of the **“Youtube Studio”**. Please click the **“EDIT”** button for setting detail information of your streaming activity. After you finish filling out those information, please click the **“SAVE”** button.

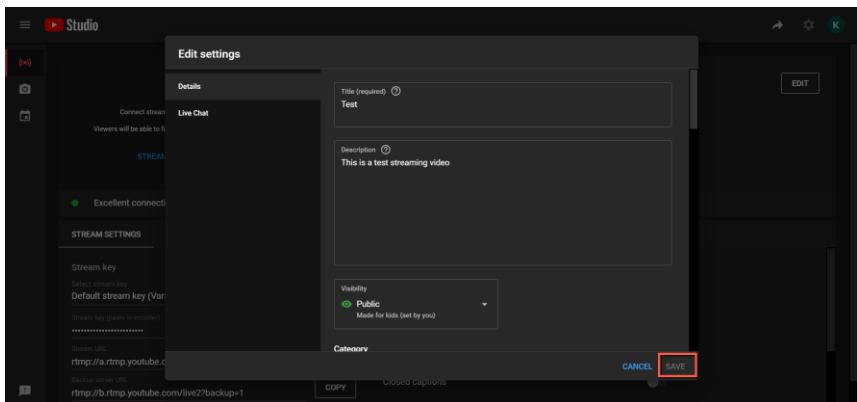
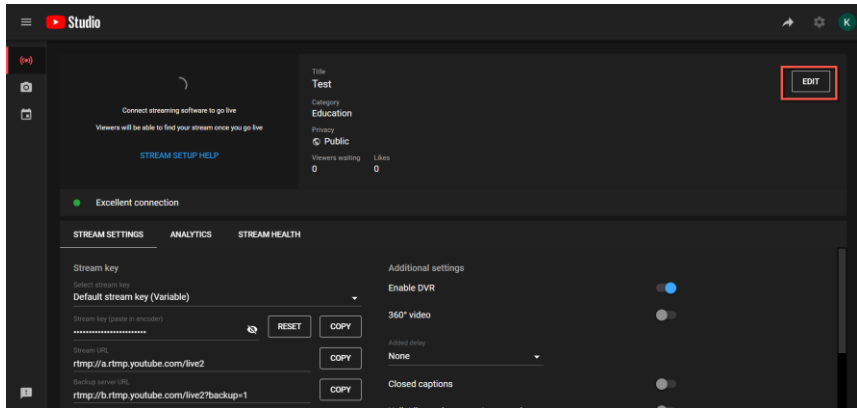

5. Users can see the Stream Key and Stream URL that are provided by the Youtube streaming platform. Please copy the stream key and stream URL and then paste them into the “**First Stream MRL**” within the “**Network**” option of the PTC-280NDI Web UI according to the following format (Stream URL/Stream Key). Please click “**On**” and please check the checkboxes of “**Audio**” and “**Video**”.

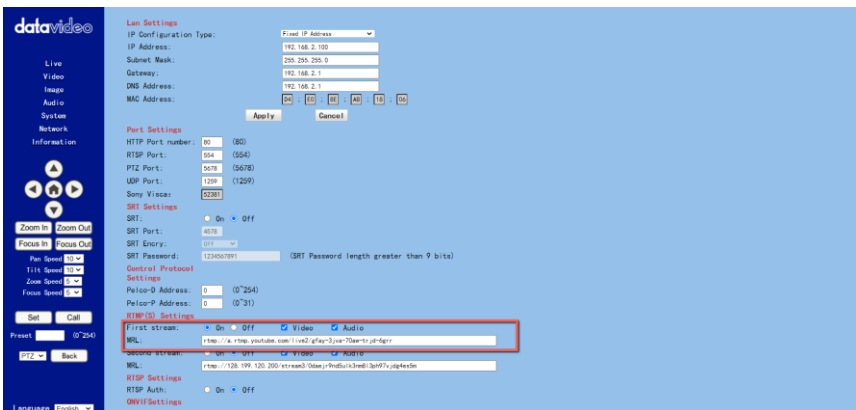
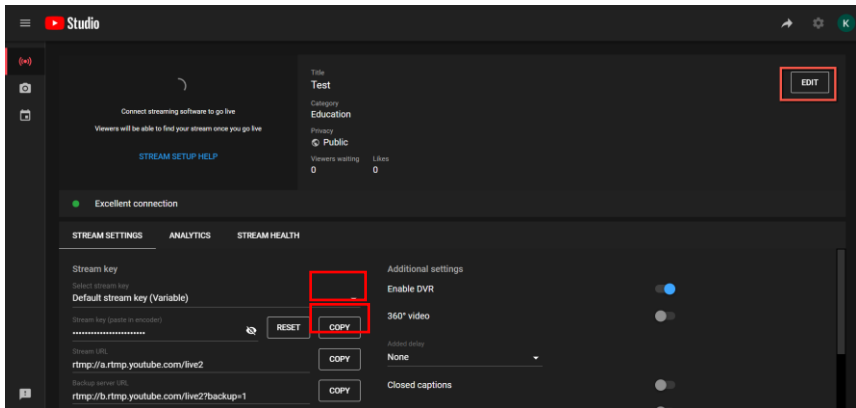

6. Please click the “Apply” button.

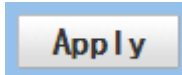

7. Please reboot the PTC-280NDI camera and then users can see the streaming is started on the Youtube Live page. If you want to stop the live streaming, please click the “END STREAM” button for stopping the live streaming.

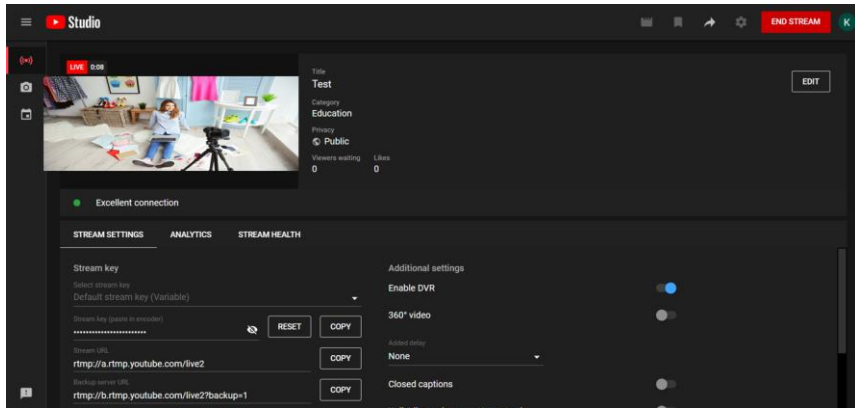



15. How to do the SRT Streaming by the vMix Software

How to install the Vmix Software

Please install the vMix software according to following steps.

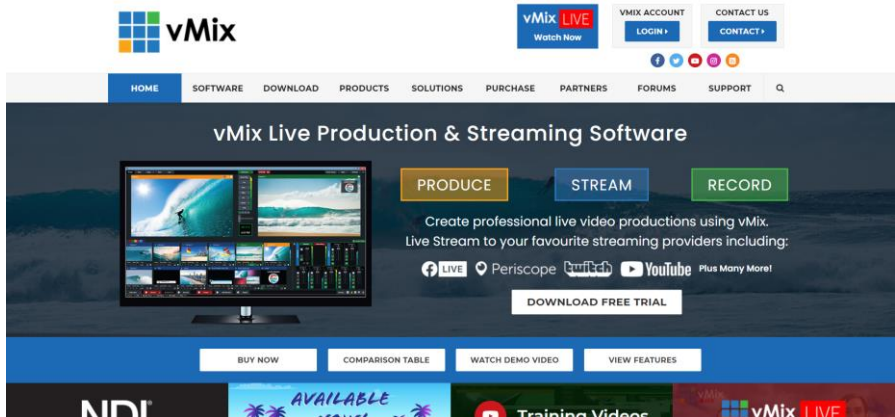
1. At first, please go to vMix official website and then download the vMix 60-day free-trial. This section will use vMix free-trial as an example to demonstrate the operation steps. Please click the “DOWNLOAD FREE TRIAL” button for downloading.



2. Please double-click the vmix23.exe  vmix23 .

3. Please click the “Next” button.

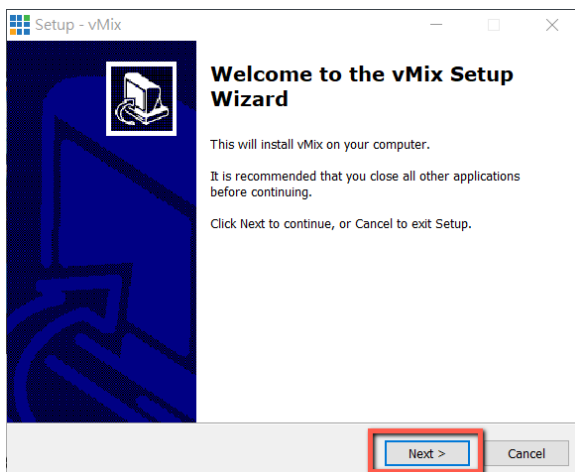

4. Please click “I accept the agreement” and then click the “Next” button.

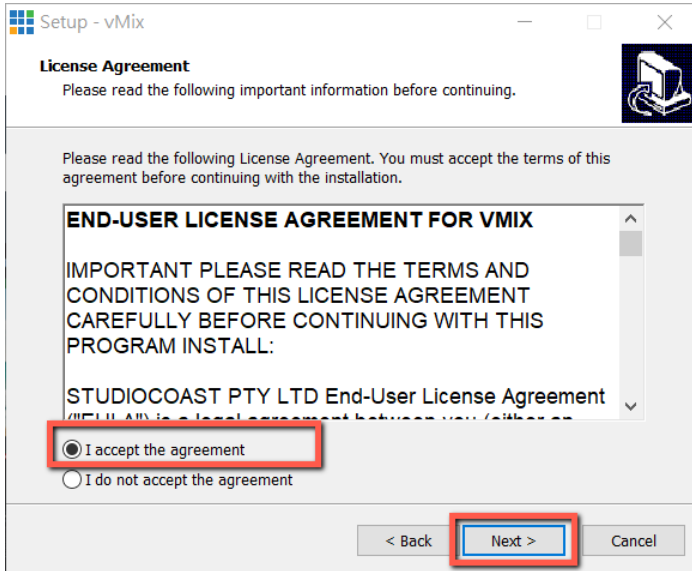

5. Please click the “Next” button.

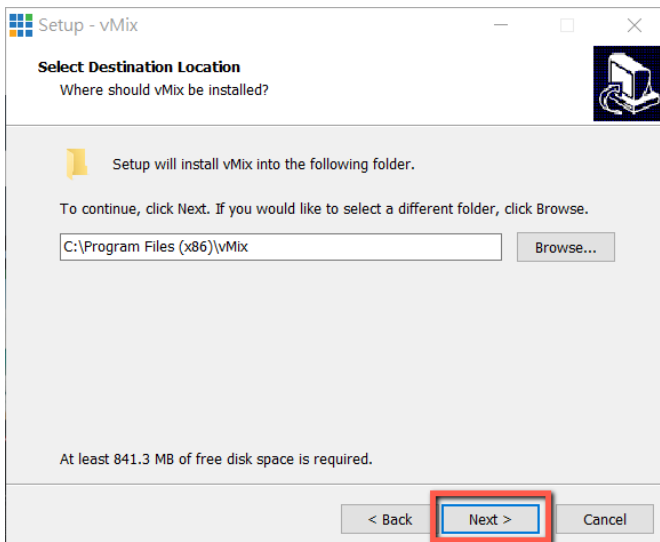

6. Please click the “Next” button.

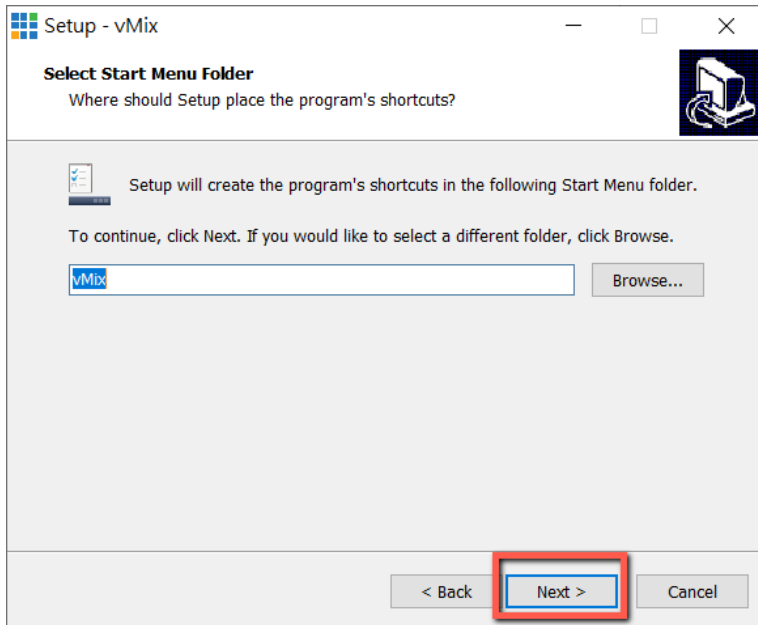

7. Please click the “Next” button.

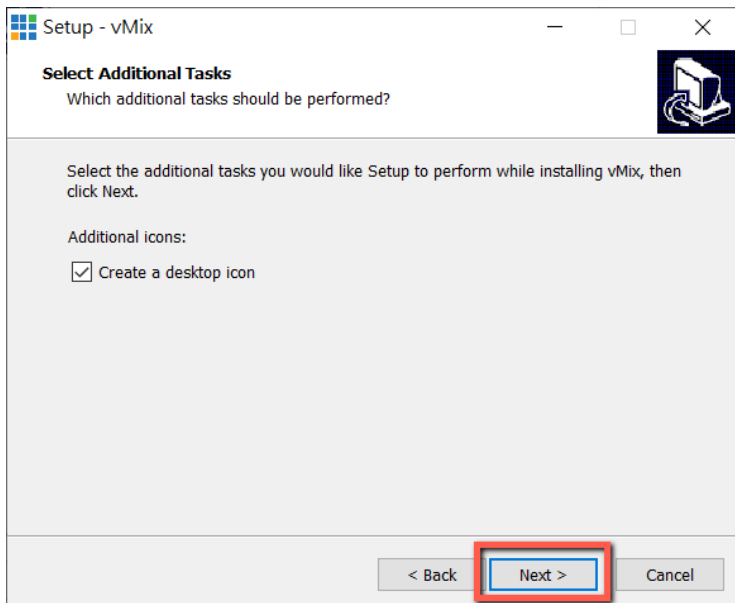

8. Please click the “Install” button.

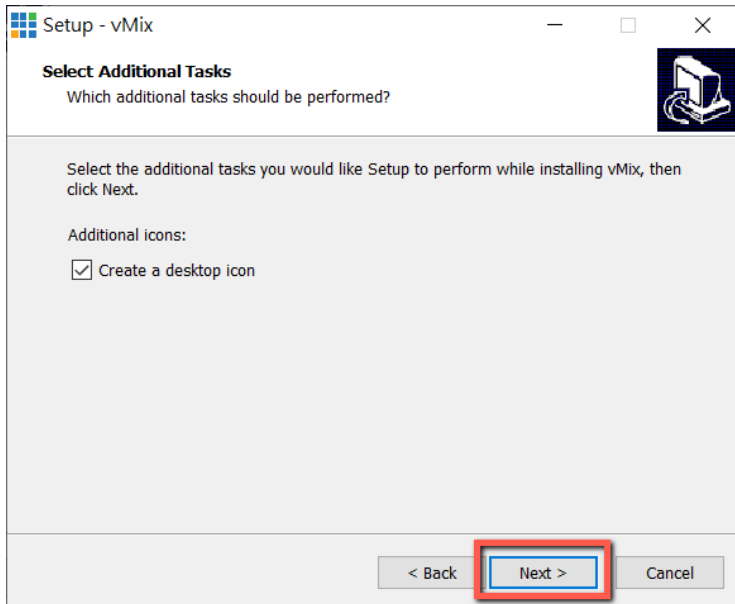

9. The installation will be started.

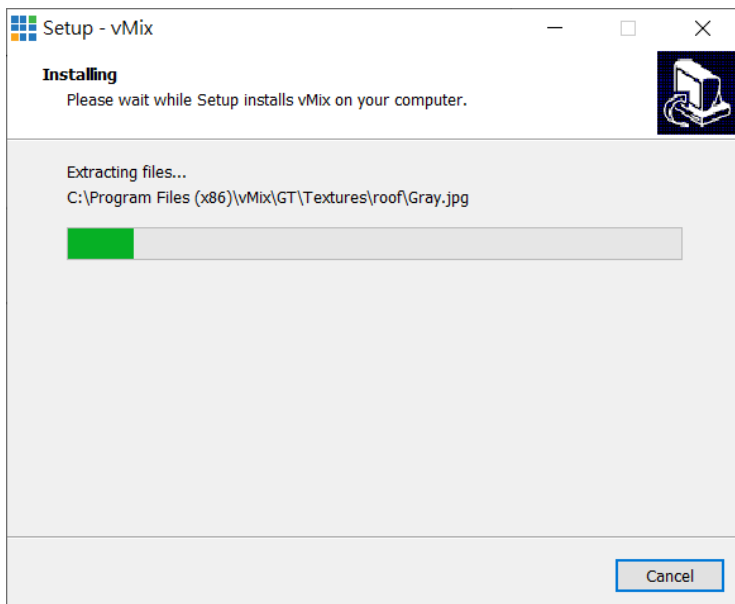

10. Please click the “Finish” button to finish the installation.

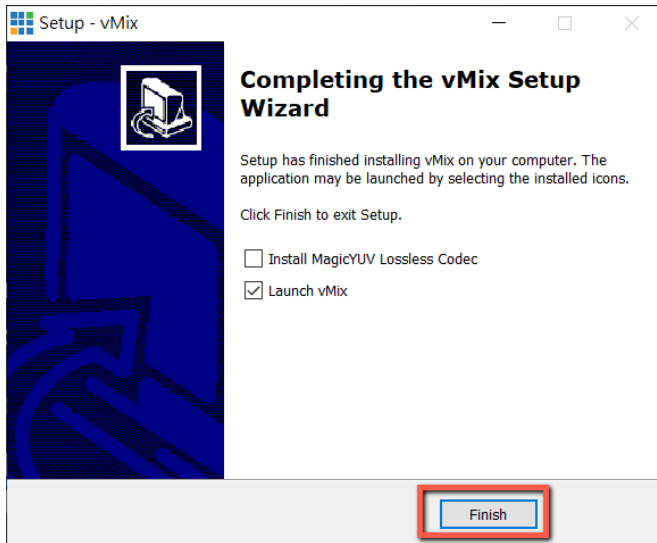

11. Please select “Register for a fully functional 60 Day Trial” to fill out your Email Address. After that, please click the “OK” button to open the vMix software.

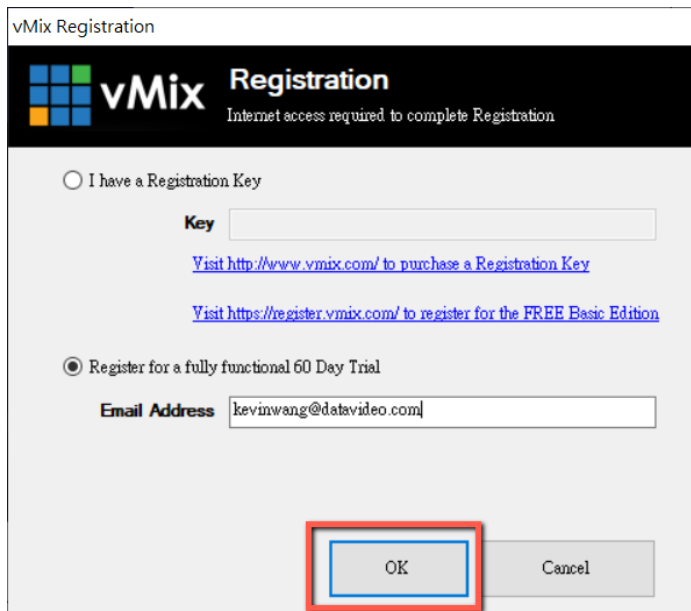

12. Please select the initial resolution and frame rate that you want to use and then please click the “OK” button.

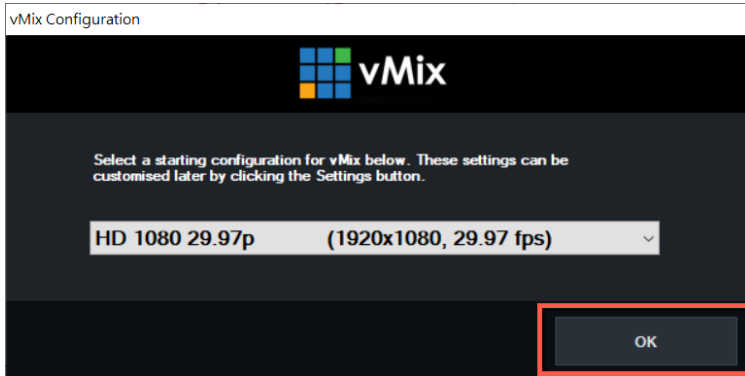

13. After opening vMix, the software interface is shown as following diagram.

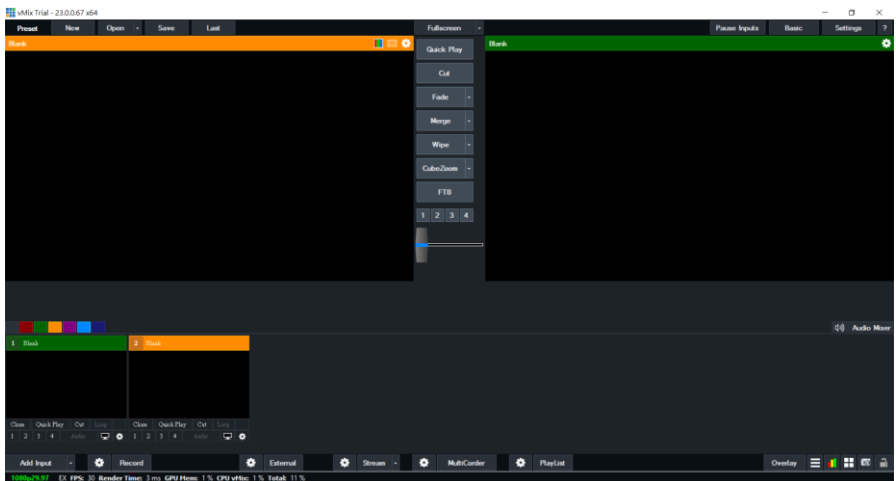

How to do the SRT Stream by Using the PTC-280NDI Camera and vMix Software

There are two modes for the SRT streaming including the Caller Mode and the Listener Mode. Please see following steps for realizing operation steps for the vMix.

If the PTC-280NDI is set in Listener Mode

Note: Due to the fact that the PTC-280NDI supports SRT Listener Mode only currently. So, please set the Vmix in SRT Caller Mode.

1. At first, please click the “Vmix(x64)” from the Start Menu to open the Vmix software.

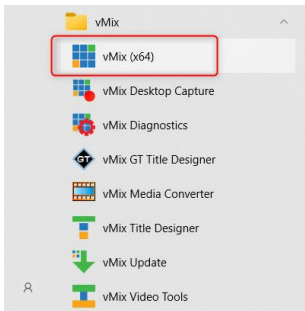

2. After that, you will see the Vmix main interface which is shown in the following diagram.

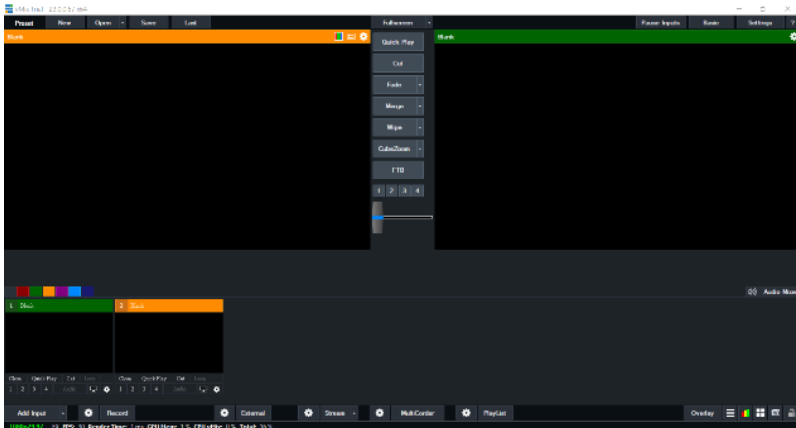

3. Please go back to the PTC-280NDI interface to make sure that the “SRT” option in the SRT Settings is “ON”. Moreover, the default value of the “SRT Port” is “4578”. The “SRT Encry” drop-down menu allows you to select your desired SRT Encryption way including AES-128, AES-192 and AES-256. The default value of the “SRT Encry” option is “Off”. In this section, we will take AES-256 as an example. If you need to set an SRT password, please enter your desired SRT password in the “SRT Password” column, it needs a 10-digit or above number. The default SRT Password is “1234567891”. After the setting for the SRT Password is finished, please press the “Apply” button which is located on the bottom side of the Web UI to apply the new setting.

The screenshot displays the configuration page for the PTC-280NDI device. On the left is a dark blue sidebar with navigation options: Live, Video, Image, Audio, System, Network, NDI® Config, and Information. Below these are control buttons for Zoom In/Out, Focus In/Out, Pan Speed, Tilt Speed, Zoom Speed, and Focus Speed, along with Set, Call, Preset, and PTZ controls. The main content area is light blue and contains several configuration sections:

- Lan Settings:** IP Configuration Type (Fixed IP Address), IP Address (192.168.50.30), Subnet Mask (255.255.255.0), Gateway (192.168.50.1), DNS Address (8.8.8.8), and MAC Address (00:07:3a:08:43:cd). Buttons for Apply and Cancel are present.
- Port Settings:** HTTP Port number (80), RTSP Port (554), PTZ Port (5678), UDP Port (1259), and Sony Visca (52381).
- SRT Settings (highlighted with a red box):** SRT (On), SRT Port (4578), SRT Encry (AES-256), and SRT Password (1234567891). A note indicates "(SRT Password length greater than 9 bits)".
- Control Protocol Settings:** Pelco-D Address (0) and Pelco-P Address (0).
- RTMP(S) Settings:** First stream (Video and Audio checked), Second stream (Video and Audio unchecked), and MRLL (rtmp://192.168.100.138/live/stream1).
- RTSP Settings:** RTSP Auth (Off).
- ONVIF Settings:** (Section header visible).

4. Please go back to the main interface of the Vmxi software and then press the “Add Input” button. After that, please select the “More” option from the drop-up menu.

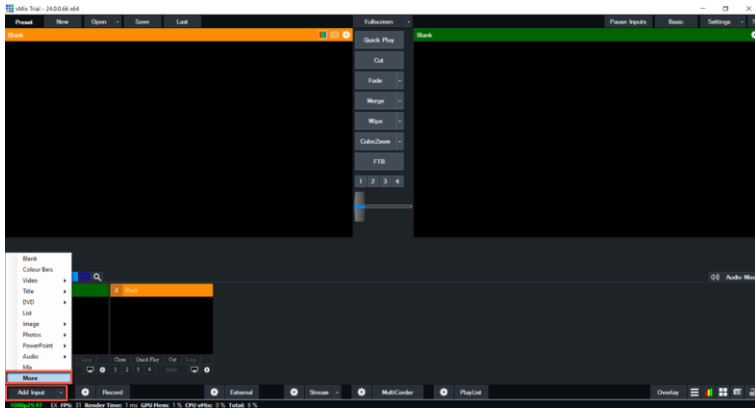

5. After the “Input Select” option is opened, please select the “Stream/SRT” option and then you can see the “Stream/SRT” interface which is shown in the following diagram.

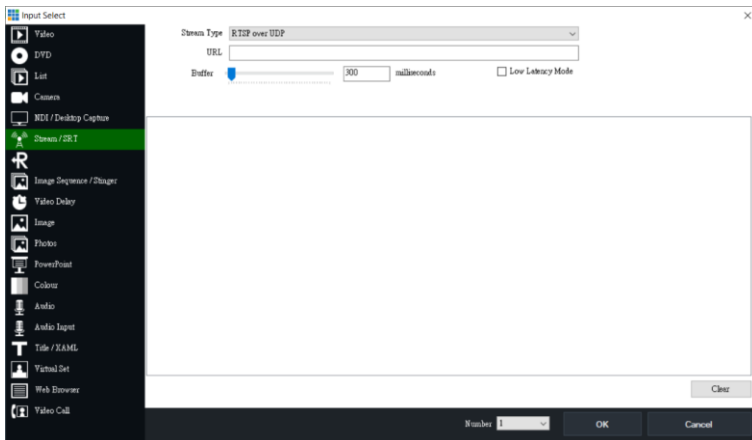

6. Please select the “SRT Caller” option from the “Stream Type” drop-down menu. After that, please enter the default static IP address “192.168.100.88” of the PTC-280NDI into the “Hostname” column. Moreover, please enter the default SRT port number “4578”, which is provided by PTC-280NDI web UI’s “SRT Port” column into the “Hostname” column. After that, please enter your SRT Password which is set in the PTC-280NDI web UI into the “Passphrase” column. The default password is “1234567891”. For the “Key Length”, please select “32” from the drop-down menu. After all of the values are entered, please press the “OK” button.

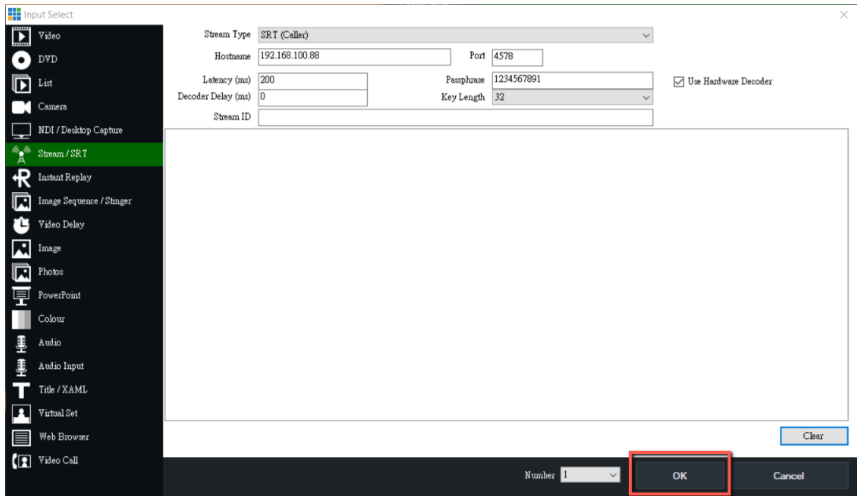

7. After that, you can see that the image which is shot by the PTC-280NDI is streamed to the vMix software by the SRT Listener Mode successfully.

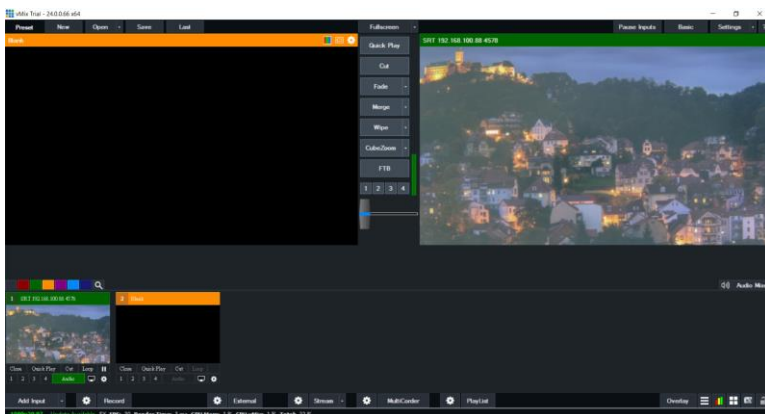

16. Remote Control Port Pinouts

In addition to using the Ethernet port for remote control, you can also connect your PC or any keyboard controllers to the RS-422 remote port to control PTC-280NDI. Use an Ethernet cable to connect the external RS-422 controller to PTC-280NDI. You can make your own cable using the pinout information provided in this chapter.

Remote Control Port

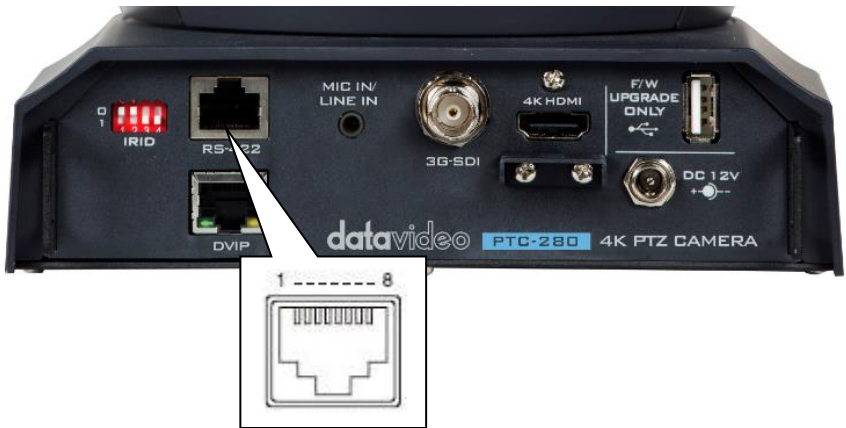

The RS-422 pinouts are described below.

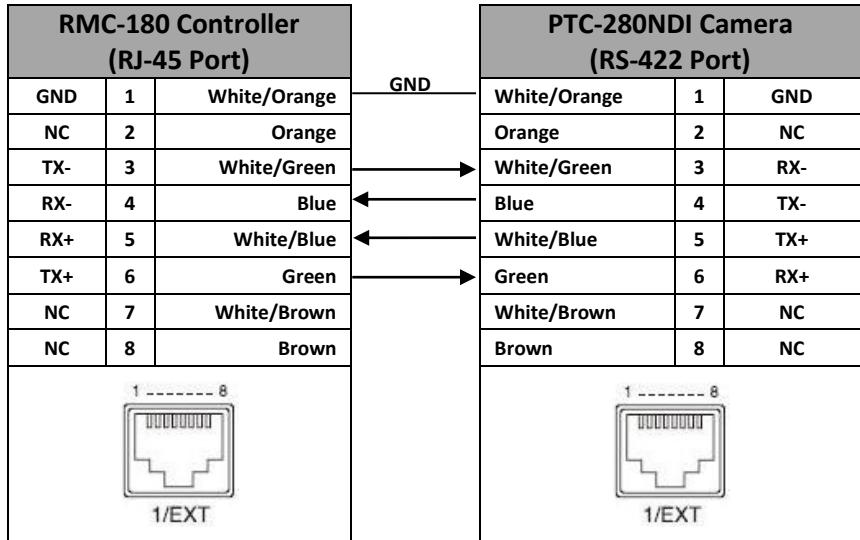

17. Firmware Update

Datavideo usually releases new firmware containing new features or reported bug fixes from time to time. Customers can either download the firmware as they wish or contact their local dealer or reseller for assistance.

This section outlines the firmware upgrade process which should take *approximately few minutes to complete*.

The existing settings should persist through the *firmware upgrade process, which should not be interrupted once started* as this could result in a non-responsive unit.

17.1 Firmware Update by the PTC-280NDI Firmware Update Tool

Requirements

- PTC-280NDI Unit
- PC/Laptop
- Latest firmware files
- Download from: <https://www.datavideo.com/product/PTC-280NDI>
- Ethernet Cable

Procedure

1. At first, please confirm that the IP address of your laptop is set within the same LAN as the PTC-280NDI camera. Please use an Ethernet cable to connect from the RJ-45 Ethernet port of your laptop to the DVIP port which is on the rear panel of the PTC-280NDI.

2. Please download the PTC-280NDI firmware “VXxxD_Ax.D_Vx.x.xxx_xx.xM_yyyyymmdd” and firmware update tool “upgrade vx.x” from Datavideo official website.

3. Please unzip the downloaded firmware and firmware update tool to the hard disk of your laptop.

4. Please double-click the firmwar3e update tool upgrade.exe  upgrade .

5. Users can see that the interface of the firmware update tool is shown as following diagram.

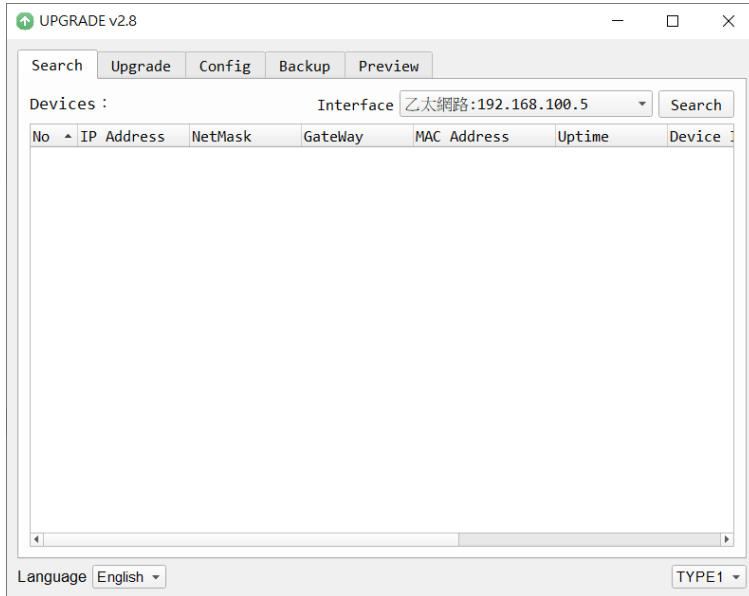

6. Please select the LAN IP address which is set by your laptop from the “Interface” drop-down menu.

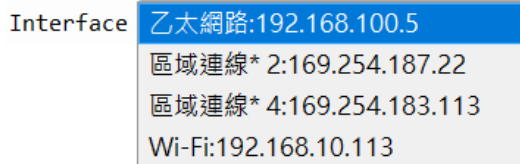

7. Please select the “Upgrade” option and then users can see the interface which is shown as following diagram.

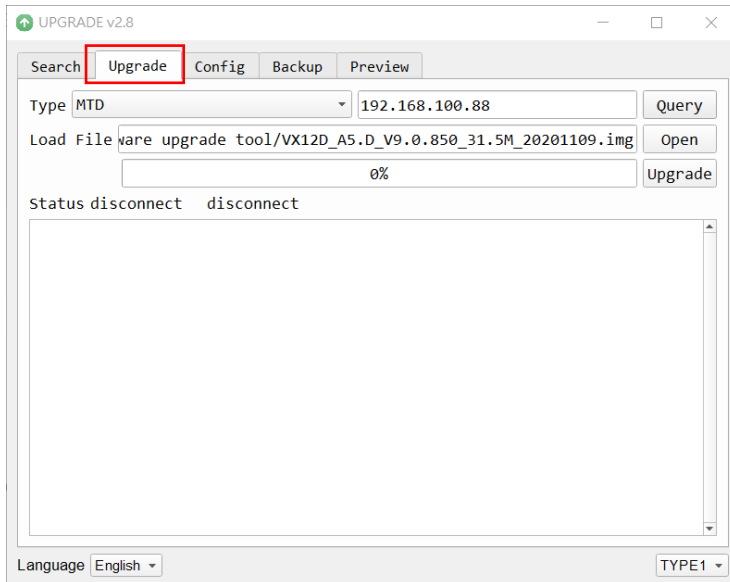

8. Please click the “Open” button and select the downloaded latest firmware.

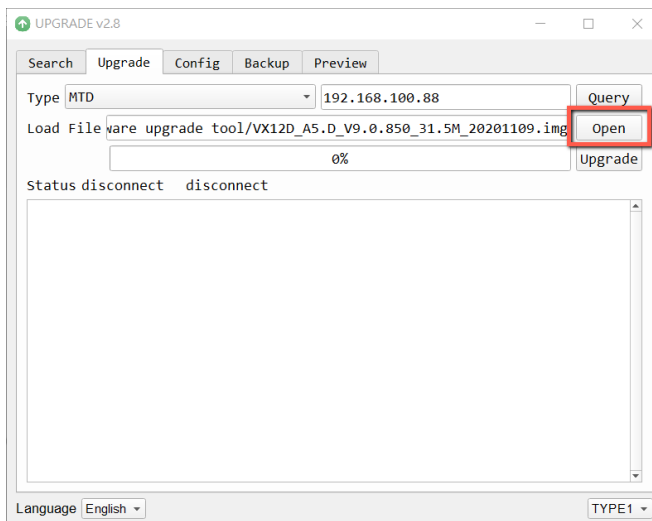

9. Please click the “Upgrade” button for starting the firmware upgrading. At this time, the external connected monitor will show the wording” **Upgrading! Please Wait!** ”

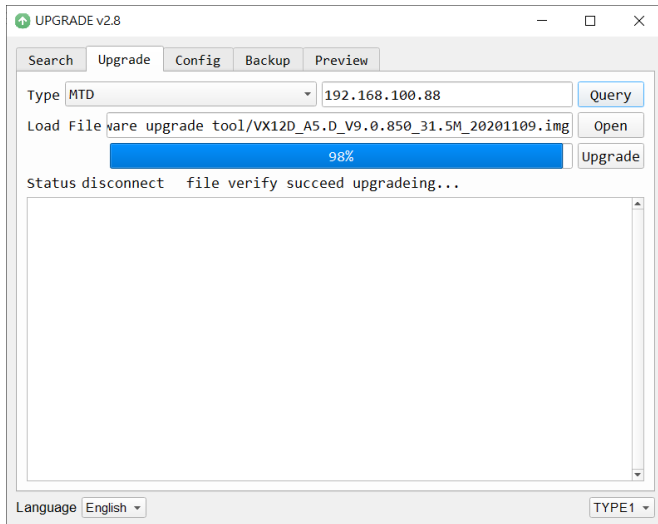

10. After the firmware upgrading is finished, the PTC-280NDI camera will reboot automatically, please click the “OK” button and then the firmware upgrade procedure is completed.

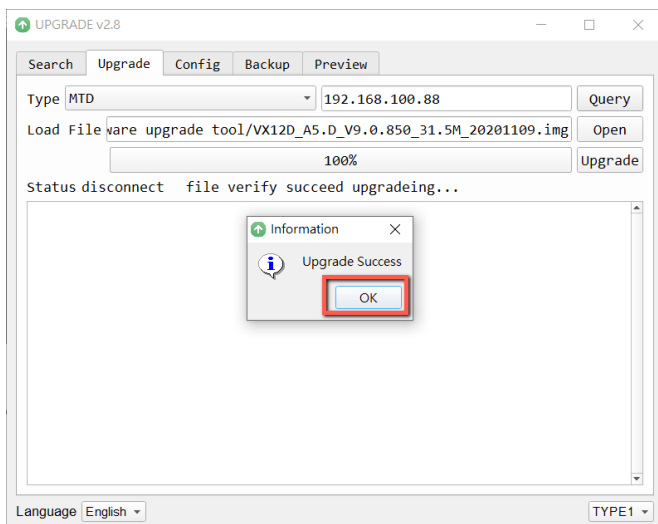

17.2 Firmware Update by the USB Flash Drive

Requirements

- PTC-280NDI Unit
- USB 2.0 or USB3.x USB Flash Drive x 1
- Laptop
- Latest firmware files

Download from: <https://www.datavideo.com/product/PTC-280NDI>

- Ethernet Cable

Procedure

1. At first, please format your USB flash drive in FAT32 format.
2. Please download the latest PTC-280NDI firmware file from Datavideo official website's PTC-280NDI product page <https://www.datavideo.com/product/PTC-280NDI> and then save it to the hard disk of your laptop.
3. Please unzip the downloaded firmware file and then save the latest firmware file "VX12D_A5.D_Vx.x.xxx_31.5M_yyyymmdd.img" into the root directory of your USB flash drive.

 VX12D_A5.D_V9.0.897_31.5M_20210312.img

4. Please insert your USB flash drive with the latest firmware file into the "F/W UPGRADE ONLY" USB interface which is located on the rear panel of the PTC-280NDI.



5. Please press the "MENU" button  from the PTC-280NDI remote controller to open the OSD menu.



6. Please press the "down-arrow" button  to move to the "Setup" option in the OSD menu.

7. After the “Setup” option is selected, please press the “Home” button



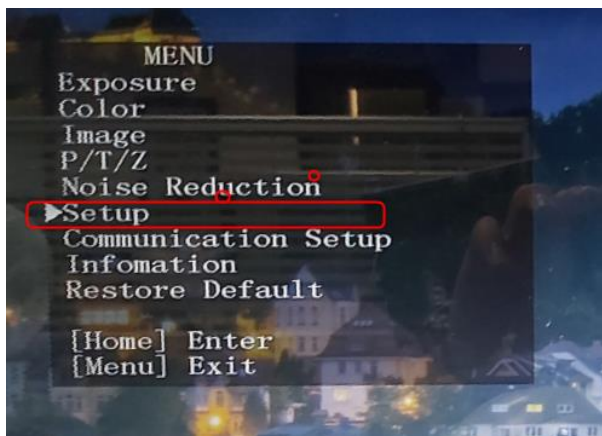

from the PTC-280NDI remote controller to enter the “Setup” page.

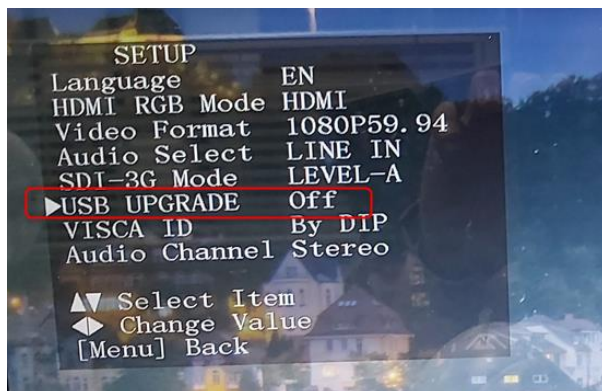

8. Please press the “down-arrow” button  from the PTC-280NDI remote controller to move to the “USB UPGRADE” option in the “Setup” page.



9. Please press the “left-arrow” or “right-arrow” button  /  to set the “USB UPGRADE” option as “ON”. After that, please press the “Home” button

 from the PTC-280NDI remote controller for confirmation and then the PTC-280NDI will start the firmware update procedure automatically. During the firmware update procedure, the warning “Updating! Please Wait!” will be shown by the external monitor. When the firmware update procedure is finished, the PTC-280 will reboot automatically. The whole firmware update procedure is done successfully.

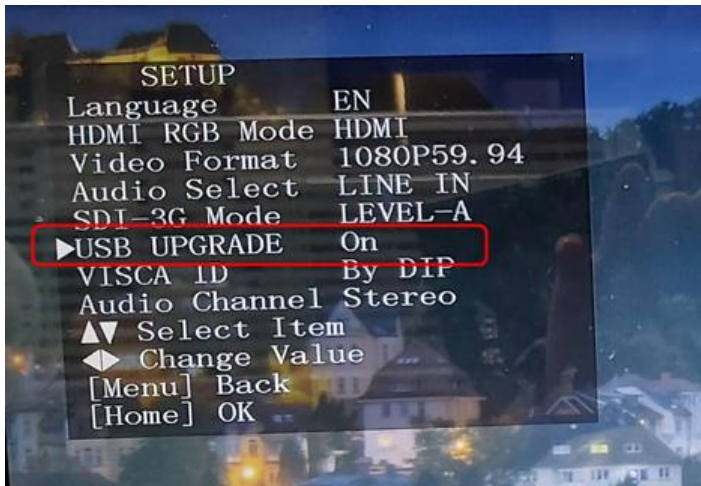

18. Frequently-Asked Questions

This section describes problems that you may encounter while using PTC-280NDI. If you have any questions, please refer to related sections and follow all suggested solutions. If problem still exists, please contact your distributor or the service center.

No.	Problems	Solutions
1.	What are important points for product maintenance?	<ol style="list-style-type: none">1. If the camera will not be used for a long time, please unplug the 12V DC power plug, and remove AC power adapter from AC outlet.2. Use soft cloth or tissue to clean the camera.3. After washing the camera lens, dry it with a soft dry cloth. Use a neutral detergent rather than acidic or corrosive detergents to clean the lens.
2.	There is no output video.	<ol style="list-style-type: none">1. Check that your power is properly connected. This is indicated by the power LED.2. After you reboot the camera, please check that whether the camera can do the self-test normally or not.3. Please check that the camera is connected correctly to the external connected monitor.
3.	I have seen image jitter while zooming in or out.	<ol style="list-style-type: none">1. Make sure the camera is properly mounted.2. Make sure that machines that could cause vibration are not in proximity of the camera.
4.	There is no image by using the IE browser.	Please go the the VLC website (http://www.videolan.org/vlc) to download the 32-bit VLC media player. After it is installed, the screen will be shown normally when connecting to the camera.

5.	The camera can not be accessed by using the IE browser.	<ol style="list-style-type: none"> 1. Use PC to access the internet to see whether it can operate normally or not. At first, please solve the network failure that is caused by the computer virus until the PC and the camera can ping each other. 2. Please remove the Ethernet cable and then connect the PC to the camera directly. After that, please reset the IP address of the PC.
6.	The remote control is not working.	<ol style="list-style-type: none"> 1. Try setting the camera to CAM1 and try again. 2. Make sure the remote control's battery is fully charged. 3. Check your device working mode. 4. Make sure the OSD menu is closed. <p>The remote control cannot be used if the OSD menu is opened.</p>
7.	The serial port is not working properly.	<ol style="list-style-type: none"> 1. Make sure your baud rate and device addresses are correct. 2. Check your device working mode. 3. Make sure the OSD menu is closed. <p>The remote control cannot be used if the OSD menu is opened.</p>
8.	Can not login to the Web control interface.	<ol style="list-style-type: none"> 1. Please check your Ethernet cable. 2. Please check your Ethernet setting such as the IP address.

19. Dimensions

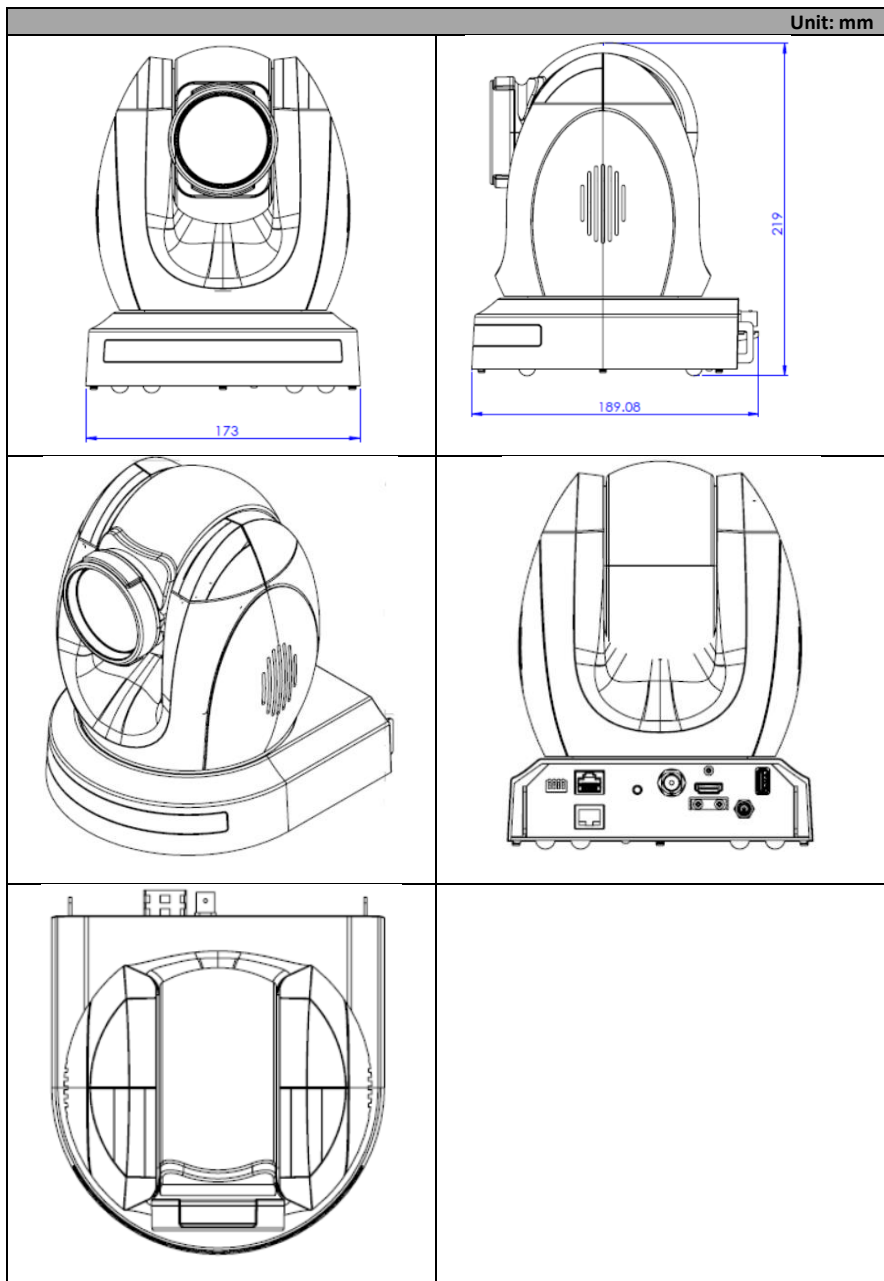

20. Specifications

Camera Parameters	
Product Name	4K NDI PTZ camera
Video Format	HDMI: 2160p 60/59.94/50/30/29.97/25 1080p 60/59.94/50/30/29.97/25 1080i 60/59.94/50 720p 60/59.94/50 SDI: 1080p 60/59.94/50/30/29.97/25 1080i 60/59.94/50 720p 60/59.94/50 (2160p 60/59.94/50 YUV 4:2:0 only)
Image Sensor	1/2.5" CMOS
Effective Pixels(approx.)	8.51Mega Pixels
S/N Ratio	≥55dB
Min. Illumination	0.5 Lux @ (F1.8, AGC ON)
Electronic Shutter	1/30s ~ 1/10000s
Zoom Ratio	12x Optical Zoom, 16x Digital Zoom
Gamma Control	Off / Normal
Iris Control	Auto / Manual
Digital Noise Reductions	2D/3D
On-Screen Display (OSD)	English、 Traditional Chinese、 Simplified Chinese、 Russian
White Balance	Auto/Indoor/Outdoor/OnePush/Manual/VAR
AGC / Gain Control	Yes
Mirror / Flip Image	Yes
Focus Mode	Auto / Manual

Panning / Tilting Range	Pan: 300 degrees, Tilt: +130 to -15 degrees
Panning / Tilting Speed	Pan: 0.876°/s~43°/s Tilt: 0.693°/s ~21.32°/s
Preset	255 Positions
Focal Length	12x, f=4.4 (wide) to 52.8 (tele) mm F1.8 to F2.6
Field of View (Horizontal, Wide)	71°
Image Compensation	Backlight Compensation
Video Output	HDMI 2.0 x1 3G-SDI x1 10/100/1000M RJ45 x1
Audio Input (MIC/Line Input)	3.5mm x 1, MIC/LIN input Compatible(SDI/HDMI/IP) 3.5mm stereo Jack Input impedance: Approx:10KΩ During MIC input Input level:-36dBV (0dB=1V/Pa,1kHz) Plug-in power compatible , supply voltage : 3V±0.5V During Lin input Input level=10dBV(Max)
Tally LED	Red/Green
Control Protocol	Pelco-D, Pelco-P, VISCA, VISCA over IP, NDI, DVIP
Remote Control Interface	IR Web GUI RS-422 DVIP NDI
Video Compression Format	H.264/H.265/MJPEG
Audio Compression Format	AAC

Audio Bitrate	96Kbps, 128Kbps, 256Kbps
Streaming Protocols	RTSP, RTMP(S), Onvif, Multicast, SRT, NDI Hx
First Stream Supported Resolution	3840x2160 1920x1080 1280x720 1024x576 960x540 640x480 640x360
Second Stream Supported Resolution	1280x720 1024x576 720x576 (50Hz) 720x480 (60Hz) 720x408 640x360 480x270 320x240
Video Bitrate	32Kbps ~ 50Mbps (Single Stream)
Video Bitrate Mode	VBR, CBR
Encoding Frame rate	50Hz: 1-50fps 60Hz: 1-60fps
POE	IEEE802.3af
F/W Update	By web UI or USB 2.0 port
IR Control	Yes
Camera Control Unit	RMC-180 series/RMC-300 series/PTZ View Assist APP
Tripod Mount	1/4-20 UNC
Optional Accessories	WM-1/ WM-10/WM-11
Color	Dark Blue/White
Dimensions	173 (W) x 219 (H) x 189.08 (D) mm
Weight	2.8kg

Operating Temp. Range	0~40 °C
Power	DC 12V 12W

Note

Note

Service & Support

It is our goal to make your products ownership a satisfying experience. Our supporting staff is available to assist you in setting up and operating your system. Please refer to our web site www.datavideo.com for answers to common questions, support requests or contact your local office below.

www.datavideo.com/product/PTC-280NDI

datavideo
www.datavideo.com



@DatavideoUSA @DatavideoIndia2016
@DatavideoEMEA @Datavideojapan
@DatavideoTaiwan @DatavideoLatam
@DatavideoAsia @DatavideoBrasil



@Datavideo
@Datavideo_EMEA
@Datavideo_Taiwan



@DatavideoUSA
@DVTWDVCN



@DatavideoUSA
@DatavideoEurope

All the trademarks are the properties of their respective owners.
Datavideo Technologies Co., Ltd. All rights reserved 2020