

**Yealink | 亿联网络**



# **UH34 Wired Headset**

## **User Guide**

Version: 1.1 | Date: May. 2021

# Contents

<b>About This Guide.....</b>	<b>3</b>
<b>Hardware Overview.....</b>	<b>3</b>
Wired Headset UH34/UH34 Lite/UH34 SE Mono.....	3
Wired Headset UH34/UH34 Lite/UH34 SE Dual.....	4
Teams/Voice Assistant Button LED Indicator.....	4
<b>UH34/UH34 Lite Headset Connection.....</b>	<b>5</b>
<b>UH34 SE Headset Connection.....</b>	<b>5</b>
Connecting to PC/Yealink IP Phone (with YHC20 SE).....	5
Connecting to Mobile Device (without YHC20 SE).....	6
<b>Headset Wear.....</b>	<b>6</b>
Left or Right Wearing Style.....	6
Adjusting the Headband.....	6
Positioning the Microphone.....	7
Storing the Microphone.....	7
<b>Basic Call Usage.....</b>	<b>8</b>
<b>Multiple Calls Handling.....</b>	<b>10</b>
<b>Yealink USB Connect.....</b>	<b>10</b>
Update Firmware.....	11
<b>FAQ.....</b>	<b>12</b>

## About This Guide

---

This guide contains instructions for connecting and using your UH34/UH34 Lite/UH34 SE headset.

## Hardware Overview

---

- [Wired Headset UH34/UH34 Lite/UH34 SE Mono](#)
- [Wired Headset UH34/UH34 Lite/UH34 SE Dual](#)
- [Teams/Voice Assistant Button LED Indicator](#)

### Wired Headset UH34/UH34 Lite/UH34 SE Mono

---

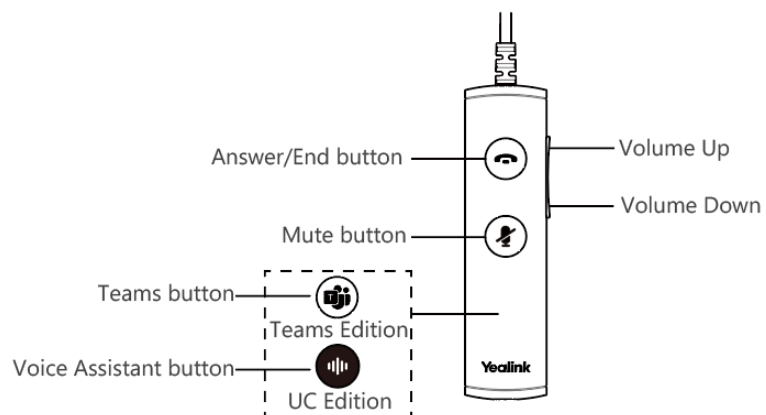
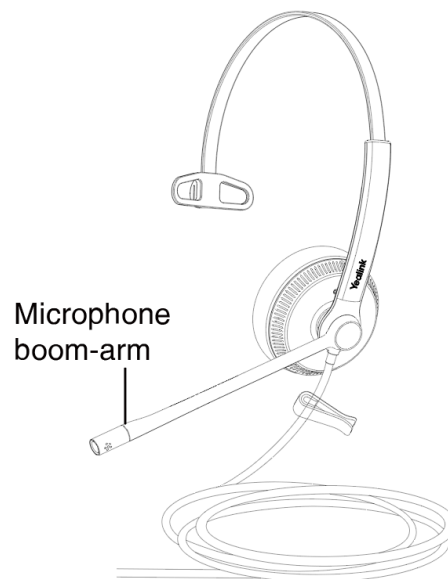

## Wired Headset UH34/UH34 Lite/UH34 SE Dual

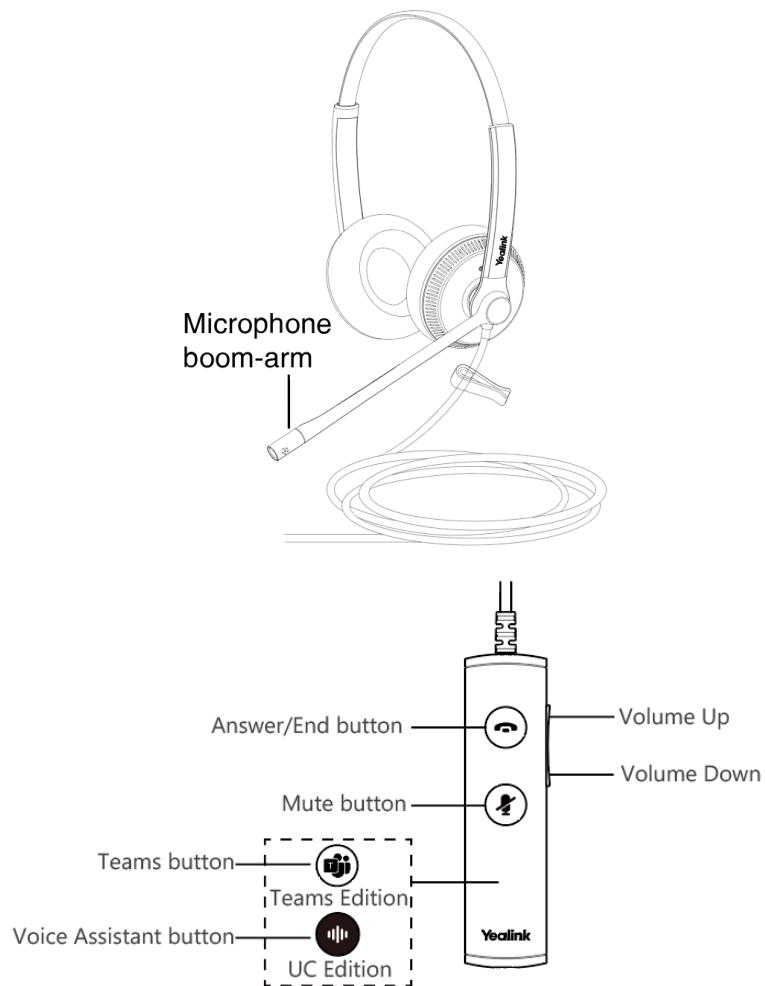

## Teams/Voice Assistant Button LED Indicator

When used with the Teams client, the button LED indicator is as follows. When the voice assistant is activated, the button always glows white.

### LED Indicator

LED Indicator	Description
Slow-flashing white	When there are missed calls/voice mails/Teams meeting notification
Solid white	Teams connected
Off	Teams disconnected

## UH34/UH34 Lite Headset Connection

---

Connect the headset to a USB port on the PC/Yealink IP phone.

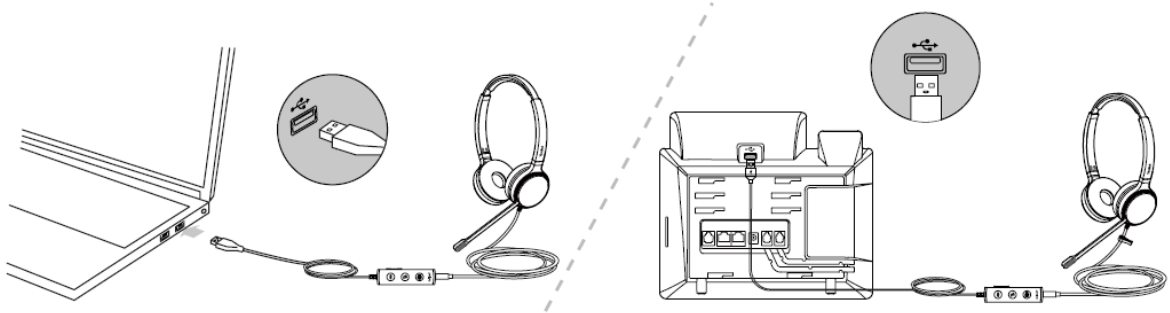

## UH34 SE Headset Connection

---

- [Connecting to PC/Yealink IP Phone \(with YHC20 SE\)](#)
- [Connecting to Mobile Device \(without YHC20 SE\)](#)

### Connecting to PC/Yealink IP Phone (with YHC20 SE)

---

Fully plug the headset into the controller YHC20 SE, and connect the YHC20 SE to a USB port on the PC/ Yealink IP phone.

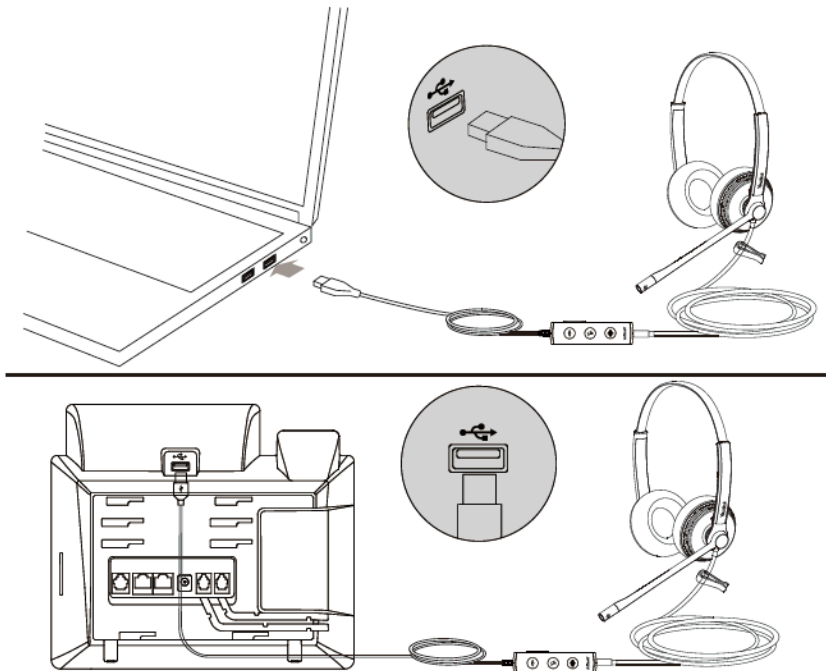

## Connecting to Mobile Device (without YHC20 SE)

---

Plug the headset directly into your mobile device.

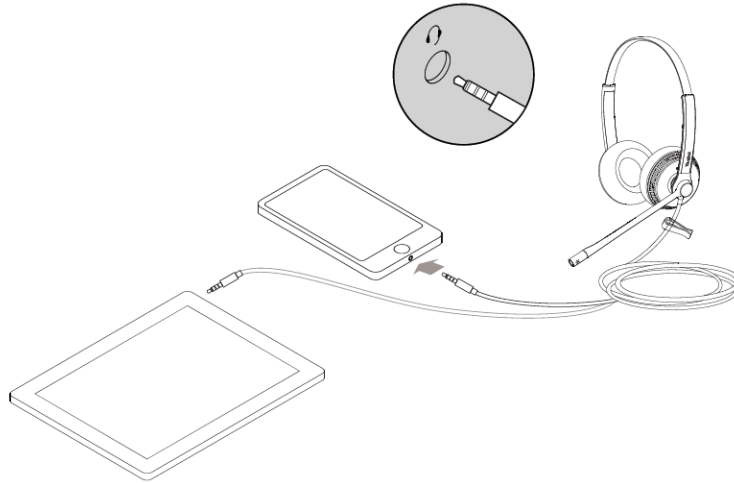

## Headset Wear

---

- [Left or Right Wearing Style](#)
- [Adjusting the Headband](#)
- [Positioning the Microphone](#)
- [Storing the Microphone](#)

### Left or Right Wearing Style

---

You can wear the headset on the left or right by flipping the microphone to the other side (320° limit).

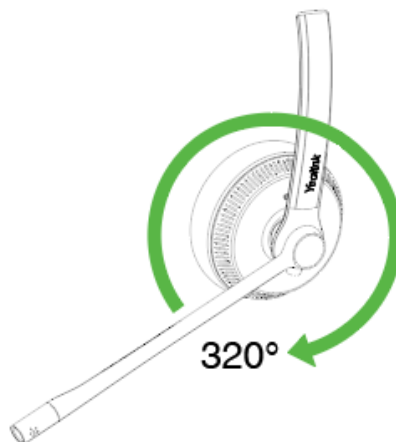

### Adjusting the Headband

---

Adjust the headband to find the most comfortable fit.



## Positioning the Microphone

---

It is recommended to position the microphone close to your mouth (0.5 inches).



The microphone is bendable for personal preference.

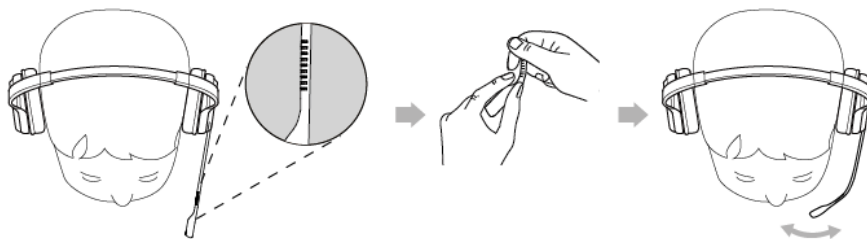

## Storing the Microphone

---

The microphone can be placed upright.

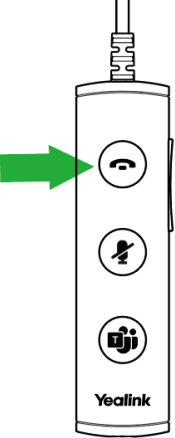

## Basic Call Usage

Headset	Function	Action
 <p>The diagram shows a vertical control panel for a Yealink headset. At the top is a connector. Below it are three circular buttons: the top one has a telephone handset icon, the middle one has a handset with a slash icon, and the bottom one has a handset with a circular arrow icon. A green arrow points to the top button. The brand name 'Yealink' is printed at the bottom of the panel.</p>	Answer call	Press the <b>Answer/End Call</b> button. <b>Note:</b> When receiving an incoming call, the Answer/End button LED flashes green. During the call, the Answer/End button LED glows green.
	End call	Press the <b>Answer/End Call</b> button.
	Reject call	Double-press the <b>Answer/End Call</b> button.
	Redial	Double-press the <b>Answer/End Call</b> button.
	Hold/resume call	Hold the <b>Answer/End Call</b> button for 2 seconds. <b>Note:</b> When a call is placed on hold, the Answer/End button LED flashes green.

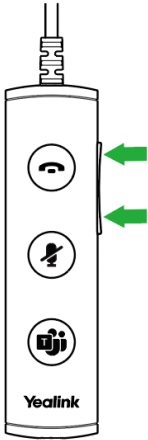
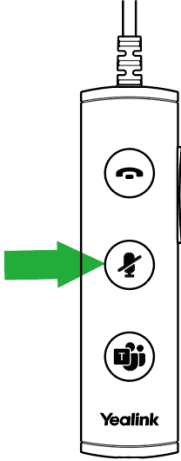
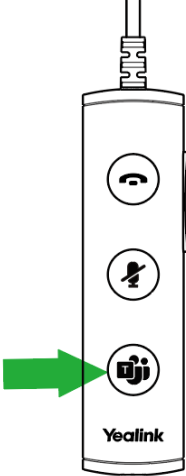

Headset	Function	Action
	Adjust volume	Press the <b>Volume Up/Volume Down</b> button.
	Mute/un-mute microphone	Press the <b>Mute</b> button. <b>Note:</b> When a call is muted, the Mute button LED glows red.
	(Teams version) Activate Cortana integrated in Teams	Hold the <b>Teams</b> button for 2 seconds. (this requires Microsoft's support).
	(Teams version) Invoke the Teams client	Press the <b>Teams</b> button in the idle state.

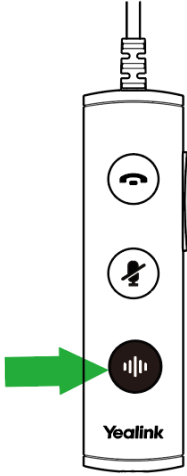
Headset	Function	Action
	(UC version) Activate voice assistant	Hold the <b>Voice Assistant</b> button for 2 seconds.

## Multiple Calls Handling

The headset and base can accept and handle multiple calls at the same time.

Multiple Call Handling	Action
End the current call and answer the incoming call	Press the <b>Call Control</b> button.
Put the current call on hold and answer the incoming call	Hold the <b>Call Control</b> button for 2 seconds.
Switch between held call and active call	Hold the <b>Call Control</b> button for 2 seconds.
Reject incoming call, while on a current call	Double-press the <b>Call Control</b> button.

## Yealink USB Connect

Yealink USB Connect is a computer software designed to manage Yealink USB devices.

With Yealink USB Connect, you can:

- Get an overview of connected Yealink USB devices
- Manage your Yealink USB devices
- Update your Yealink USB device to enhance its performance and features
- Give feedback on your Yealink USB device

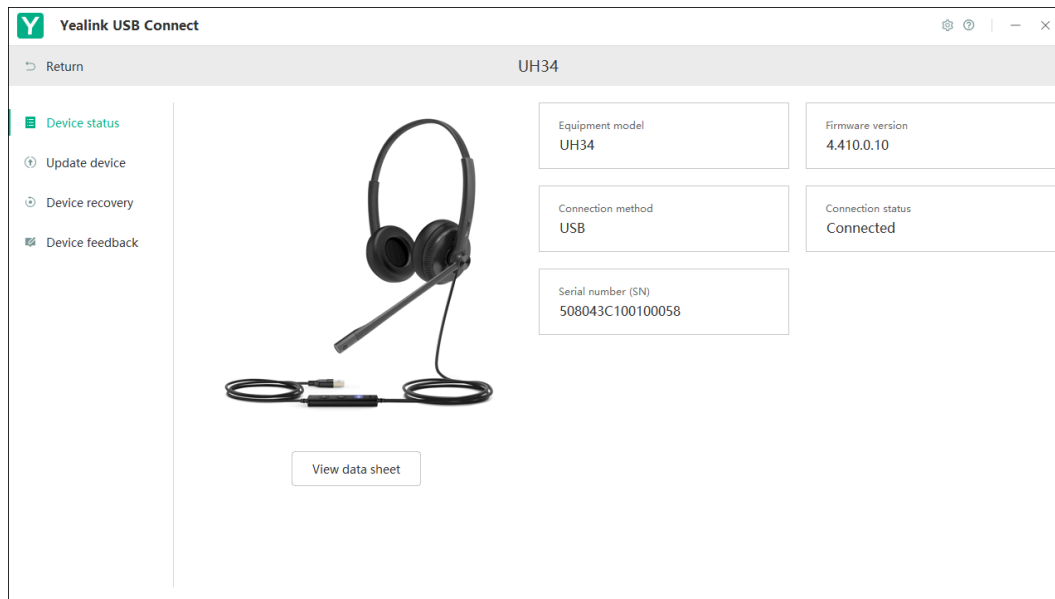

For more information on Yealink USB Connect, refer to [Yealink USB Device Manager Client User Guide](#).

 **Note:** Download via [support.yealink.com](https://support.yealink.com).

- [Update Firmware](#)

## Update Firmware

### Procedure

1. Connect the headset to the USB port of PC.
2. Update the headset firmware via Yealink USB Connect.
  - Check for updates
  - Update manually

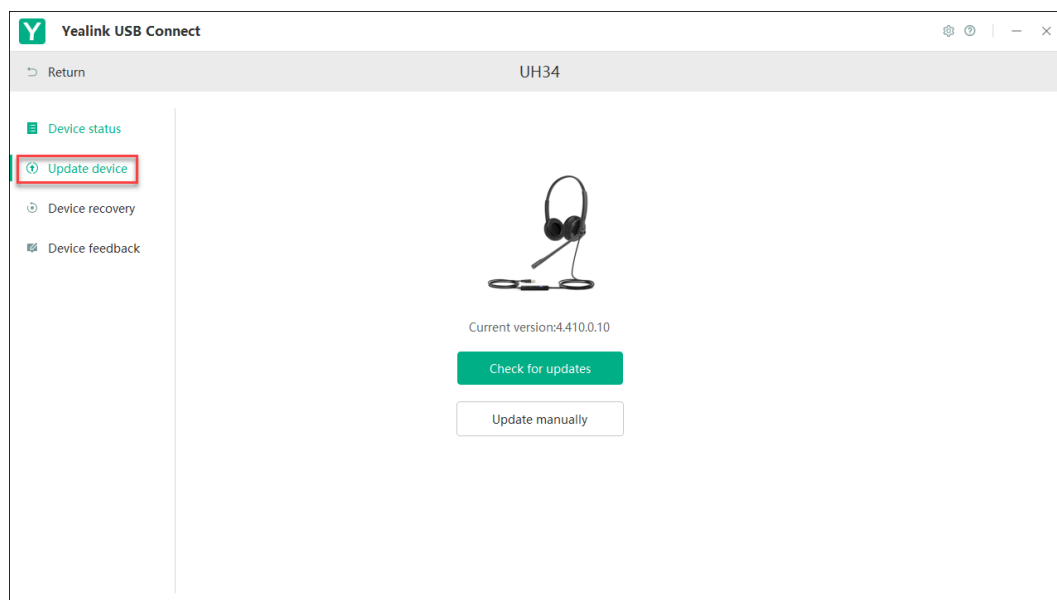

For more information on Yealink USB Connect, refer to [Yealink USB Device Manager Client User Guide](#).

# FAQ

---

View the FAQ guide on <http://support.yealink.com/>.