

Liquid Freezer III 420 A-RGB

Multi Compatible All-in-One CPU Water Cooler with A-RGB



General Specifications

Compatibility	Intel® LGA1851, LGA1700 AMD® AM5, AM4
PI NNPI	374 339
TIM	MX-6 (0.8g)
Warranty	6 Years
Operating Ambient Temperature	0-40°C
Weight	2325g
LED-Connector	3-Pin A-RGB Connector

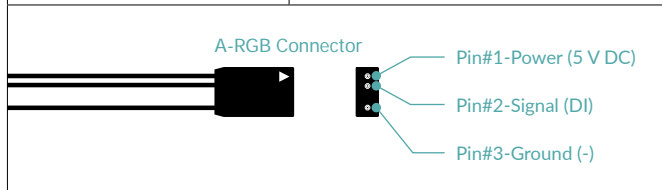

All-In-One Connector	4-Pin PWM Connector
----------------------	---------------------

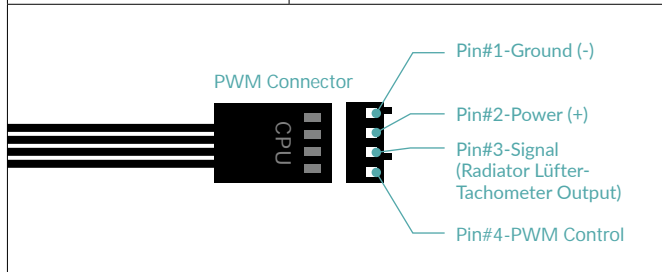

Split Connector	3x 4-Pin PWM Connector
-----------------	------------------------

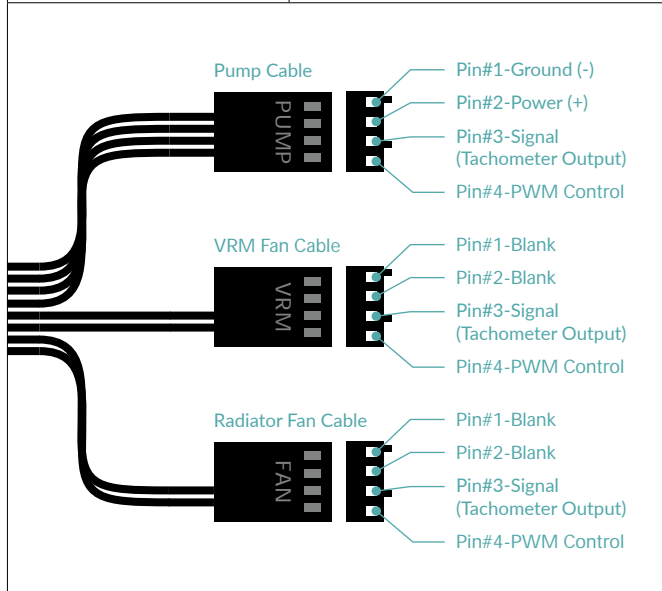

Pump	800-2800rpm (PWM controlled)
Current Voltage	0.35 A 12 VDC
Cold Plate	Copper, Micro Skived Fins
Tube Length	450mm
Tube Diameter	Outer: 12.4 mm Inner: 6.0mm
Radiator	
Material	Aluminium
Dimensions	458 (L) x 138 (W) x 38 (H) mm
VRM Modul	
VRM Fan	400-2500rpm (PWM controlled)
Current Voltage	0.05 A 12 VDC
LEDs	12x A-RGB LEDs
Current Voltage	0.40 A 5VDC

Radiator Fan Specifications

General	3x P14 PWM A-RGB
Speed	200-1900rpm
Airflow	69.90cfm 117.06 m³/h
Static Pressure	2.0mmH ₂ O
Bearing	Fluid Dynamic Bearing
Current Voltage	0.17 A 12VDC
Cable Length	40 mm
Connector	4-Pin PWM Connector
RGB Specifications	
LEDs	12x A-RGB LEDs
Current Voltage	0.40 A 5VDC
Cable Length	40 mm + 80mm Splitter Cable
Connector	3-Pin A-RGB Connector + 3-Pin Plug

Shipping Information - LF III 420 A-RGB (Black)

Box Dimension	447 (L) x 328 (W) x 158 (H) mm
Gross Weight	3000 g
SKU	ACFRE00145A
EAN	4895213704533
UPC	840033402309

Shipping Information - LF III 420 A-RGB (White)

Box Dimension	447 (L) x 328 (W) x 158 (H) mm
Gross Weight	3000 g
SKU	ACFRE00153A
EAN	4895213704571
UPC	840033402347

Liquid Freezer III 420 A-RGB

Multi Compatible All-in-One CPU Water Cooler with A-RGB

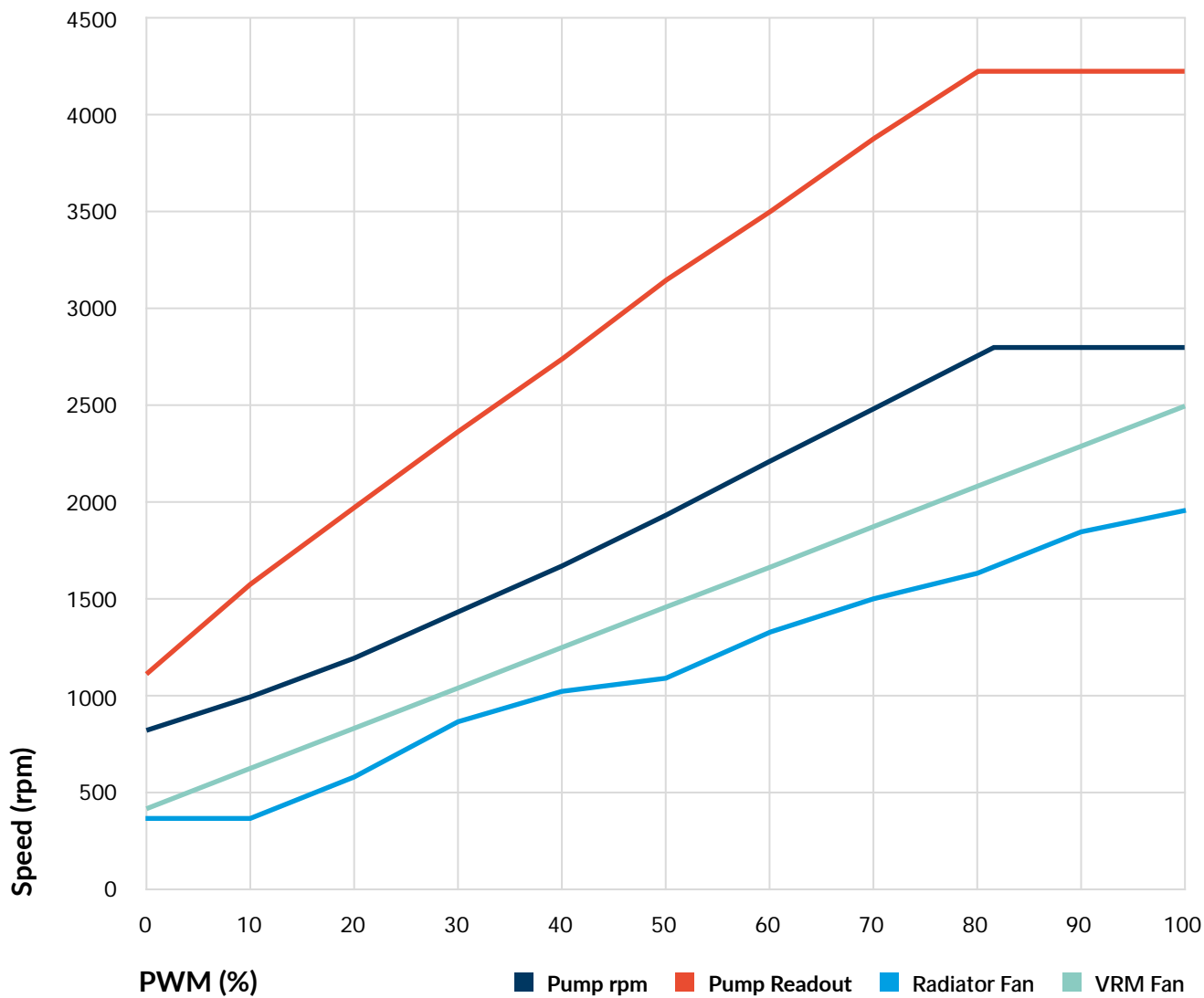

Liquid Freezer III 420 A-RGB

Multi Compatible All-in-One CPU Water Cooler with A-RGB

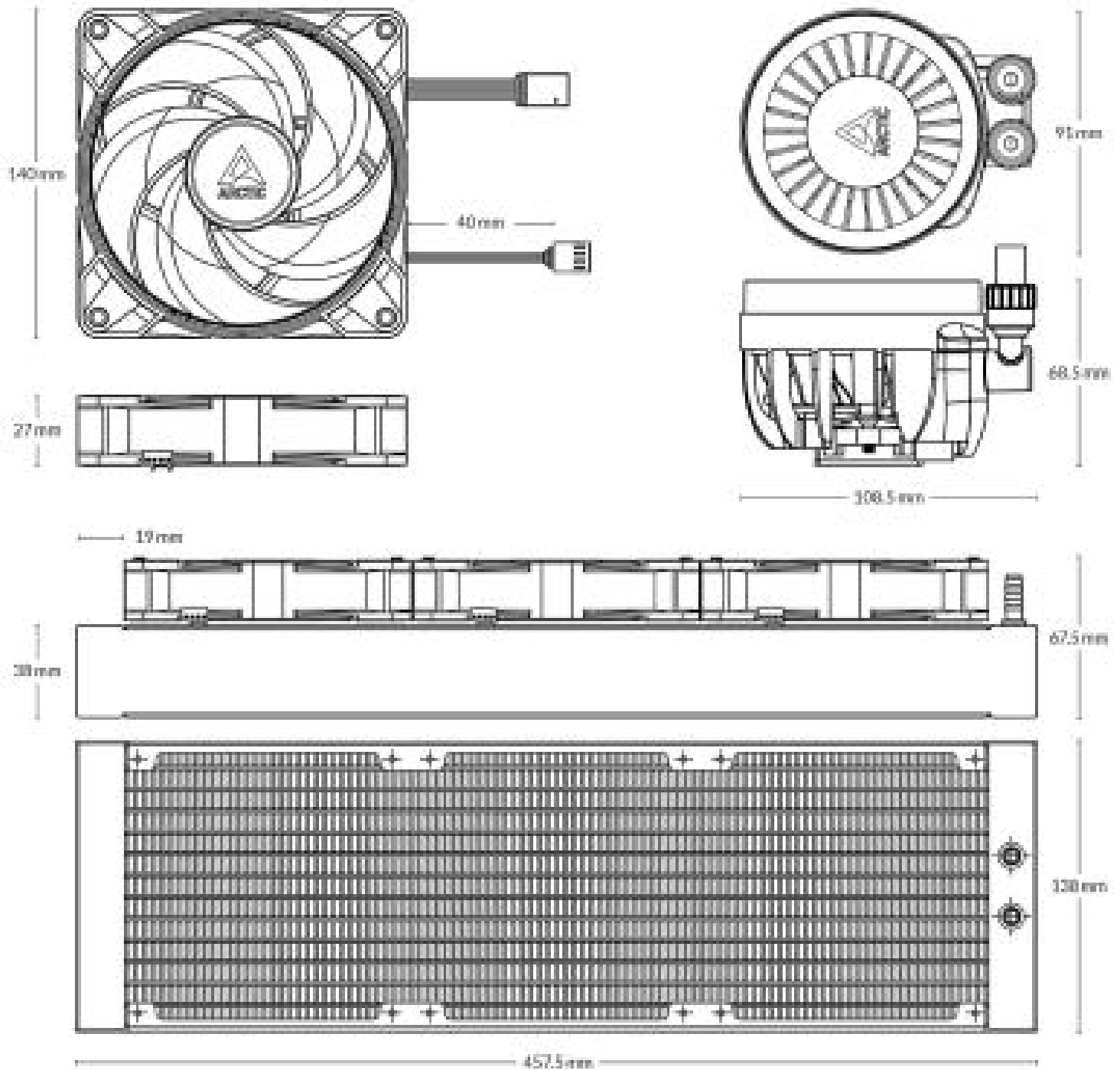

All materials are compatible with RoHS requirements.

MORE INFORMATION



MANUALS

