

ASUS[®]

PA169CDV

LCD Monitor

User Guide

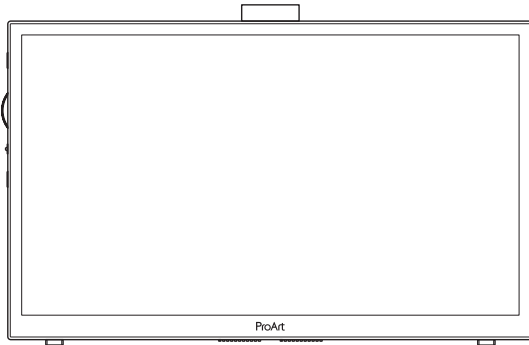

HDMI[™]
HIGH-DEFINITION MULTIMEDIA INTERFACE

First Edition

July 2023

Copyright © 2023 ASUSTeK COMPUTER INC. All Rights Reserved.

No part of this manual, including the products and software described in it, may be reproduced, transmitted, transcribed, stored in a retrieval system, or translated into any language in any form or by any means, except documentation kept by the purchaser for backup purposes, without the express written permission of ASUSTeK COMPUTER INC. ("ASUS").

Product warranty or service will not be extended if: (1) the product is repaired, modified or altered, unless such repair, modification or alteration is authorized in writing by ASUS; or (2) the serial number of the product is defaced or missing.

ASUS PROVIDES THIS MANUAL "AS IS" WITHOUT WARRANTY OF ANY KIND, EITHER EXPRESS OR IMPLIED, INCLUDING BUT NOT LIMITED TO THE IMPLIED WARRANTIES OR CONDITIONS OF MERCHANTABILITY OR FITNESS FOR A PARTICULAR PURPOSE. IN NO EVENT SHALL ASUS, ITS DIRECTORS, OFFICERS, EMPLOYEES OR AGENTS BE LIABLE FOR ANY INDIRECT, SPECIAL, INCIDENTAL, OR CONSEQUENTIAL DAMAGES (INCLUDING DAMAGES FOR LOSS OF PROFITS, LOSS OF BUSINESS, LOSS OF USE OR DATA, INTERRUPTION OF BUSINESS AND THE LIKE), EVEN IF ASUS HAS BEEN ADVISED OF THE POSSIBILITY OF SUCH DAMAGES ARISING FROM ANY DEFECT OR ERROR IN THIS MANUAL OR PRODUCT.

SPECIFICATIONS AND INFORMATION CONTAINED IN THIS MANUAL ARE FURNISHED FOR INFORMATIONAL USE ONLY, AND ARE SUBJECT TO CHANGE AT ANY TIME WITHOUT NOTICE, AND SHOULD NOT BE CONSTRUED AS A COMMITMENT BY ASUS. ASUS ASSUMES NO RESPONSIBILITY OR LIABILITY FOR ANY ERRORS OR INACCURACIES THAT MAY APPEAR IN THIS MANUAL, INCLUDING THE PRODUCTS AND SOFTWARE DESCRIBED IN IT.

Products and corporate names appearing in this manual may or may not be registered trademarks or copyrights of their respective companies, and are used only for identification or explanation and to the owners' benefit, without intent to infringe.

Contents

Notices.....	iv
Safety information	v
Care & Cleaning	vi
Takeback Services.....	vii
Product information for EU energy label.....	vii
Chapter 1: Product introduction	
1.1 Welcome!	1-1
1.2 Package contents.....	1-1
1.3 Monitor introduction	1-2
1.3.1 Front view	1-2
1.3.2 Back view	1-3
1.3.3 QuickFit Plus Function	1-4
1.3.4 Other Function(s)	1-6
Chapter 2: Setup	
2.1 Adjusting the monitor.....	2-1
2.2 Connecting the cables.....	2-2
2.3 Turning on the monitor.....	2-4
2.4 Touch Operation	2-4
Chapter 3: General instructions	
3.1 OSD (On-Screen Display) menu	3-1
3.1.1 How to reconfigure.....	3-1
3.1.2 OSD function introduction	3-2
3.2 Specifications Summary	3-12
3.3 Outline dimensions.....	3-14
3.4 Troubleshooting (FAQ).....	3-15
3.5 Supported operating modes	3-16

Notices

Federal Communications Commission Statement

This device complies with Part 15 of the FCC Rules. Operation is subject to the following two conditions:

- This device may not cause harmful interference, and
- This device must accept any interference received including interference that may cause undesired operation.

This equipment has been tested and found to comply with the limits for a Class B digital device, pursuant to Part 15 of the FCC Rules. These limits are designed to provide reasonable protection against harmful interference in a residential installation. This equipment generates, uses and can radiate radio frequency energy and, if not installed and used in accordance with manufacturer's instructions, may cause harmful interference to radio communications. However, there is no guarantee that interference will not occur in a particular installation. If this equipment does cause harmful interference to radio or television reception, which can be determined by turning the equipment off and on, the user is encouraged to try to correct the interference by one or more of the following measures:

- Reorient or relocate the receiving antenna.
- Increase the separation between the equipment and receiver.
- Connect the equipment to an outlet on a circuit different from that to which the receiver is connected.
- Consult the dealer or an experienced radio/TV technician for help.



The use of shielded cables for connection of the monitor to the graphics card is required to assure compliance with FCC regulations. Changes or modifications to this unit not expressly approved by the party responsible for compliance could void the user's authority to operate this equipment.

Canadian Department of Communications Statement

This digital apparatus does not exceed the Class B limits for radio noise emissions from digital apparatus set out in the Radio Interference Regulations of the Canadian Department of Communications.

This class B digital apparatus complies with Canadian ICES-003.

This Class B digital apparatus meets all requirements of the Canadian Interference - Causing Equipment Regulations.

Cet appareil numérique de la classe B respecte toutes les exigences du Règlement sur le matériel brouiller du Canada.

Safety information

- Before setting up the monitor, carefully read all the documentation that came with the package.
- To prevent fire or shock hazard, never expose the monitor to rain or moisture.
- Never try to open the monitor cabinet. The dangerous high voltages inside the monitor may result in serious physical injury.
- If the power supply is broken, do not try to fix it by yourself. Contact a qualified service technician or your retailer.
- Before using the product, make sure all cables are correctly connected and the power cables are not damaged. If you detect any damage, contact your dealer immediately.
- Slots and openings on the back or top of the cabinet are provided for ventilation. Do not block these slots. Never place this product near or over a radiator or heat source unless proper ventilation is provided.
- The monitor should be operated only from the type of power source indicated on the label. If you are not sure of the type of power supply to your home, consult your dealer or local power company.
- Use the appropriate power plug which complies with your local power standard.
- Do not overload power strips and extension cords. Overloading can result in fire or electric shock.
- Avoid dust, humidity, and temperature extremes. Do not place the monitor in any area where it may become wet. Place the monitor on a stable surface.
- Unplug the unit during a lightning storm or if it will not be used for a long period of time. This will protect the monitor from damage due to power surges.
- Never push objects or spill liquid of any kind into the slots on the monitor cabinet.
- To ensure satisfactory operation, use the monitor only with UL listed computers which have appropriate configured receptacles marked between 100-240V AC.
- If you encounter technical problems with the monitor, contact a qualified service technician or your retailer.
- Adjustment of the volume control as well as the equalizer to other settings than the center position may increase the ear-/headphones output voltage and therefore the sound pressure level.



This symbol of the crossed out wheeled bin indicates that the product (electrical, electronic equipment, and mercury-containing button cell battery) should not be placed in municipal waste. Please check local regulations for disposal of electronic products.

AEEE yönetmeliğine uygundur

Care & Cleaning

- Before you lift or reposition your monitor, it is better to disconnect the cables and power cord. Follow the correct lifting techniques when positioning the monitor. When lifting or carrying the monitor, grasp the edges of the monitor. Do not lift the display by the stand or the cord.
- Cleaning. Turn your monitor off and unplug the power cord. Clean the monitor surface with a lint-free, non-abrasive cloth. Stubborn stains may be removed with a cloth dampened with mild cleaner.
- Avoid using a cleaner containing alcohol or acetone. Use a cleaner intended for use with the LCD. Never spray cleaner directly on the screen, as it may drip inside the monitor and cause an electric shock.

The following symptoms are normal with the monitor:

- You may find slightly uneven brightness on the screen depending on the desktop pattern you use.
- When the same image is displayed for hours, an afterimage of the previous screen may remain after switching the image. The screen will recover slowly or you can turn off the Power Switch for hours.
- When the screen becomes black or flashes, or cannot work anymore, contact your dealer or service center to fix it. Do not repair the screen by yourself!

Conventions used in this guide



WARNING: Information to prevent injury to yourself when trying to complete a task.



CAUTION: Information to prevent damage to the components when trying to complete a task.



IMPORTANT: Information that you **MUST** follow to complete a task.



NOTE: Tips and additional information to aid in completing a task.

Where to find more information

Refer to the following sources for additional information and for product and software updates.

1. **ASUS websites**

The ASUS websites worldwide provide updated information on ASUS hardware and software products. Refer to <http://www.asus.com>

2. **Optional documentation**

Your product package may include optional documentation that may have been added by your dealer. These documents are not part of the standard package.

Takeback Services

ASUS recycling and takeback programs come from our commitment to the highest standards for protecting our environment. We believe in providing solutions for our customers to be able to responsibly recycle our products, batteries and other components as well as the packaging materials.

Please go to <http://csr.asus.com/english/Takeback.htm> for detail recycling information in different region.

Product information for EU energy label



1.1 Welcome!

Thank you for purchasing the ASUS® LCD monitor!

The latest widescreen LCD monitor from ASUS provides a crisper, broader, and brighter display, plus a host of features that enhance your viewing experience.

With these features, you can enjoy the convenience and delightful visual experience that the monitor brings to you!

1.2 Package contents

Check your package for the following items:

- ✓ LCD monitor
- ✓ Carry bag
- ✓ Calibration report
- ✓ Quick start guide
- ✓ Warranty card
- ✓ Power cable
- ✓ Adapter
- ✓ HDMI cable
- ✓ USB Type-C cable
- ✓ ProArt Pen
- ✓ Pen nibs and tweezer



If any of the above items is damaged or missing, contact your local retailer.

1.3 Monitor introduction

1.3.1 Front view

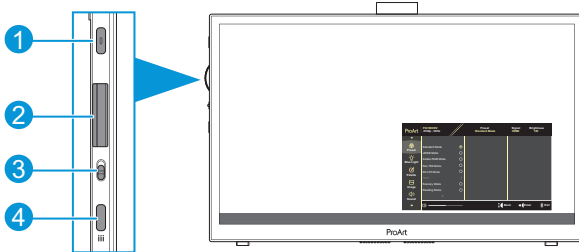

1. Power Button/Power Indicator:

- Turn the monitor on/off.
- The color definition of the power indicator is as the below table.

Status	Description
White	ON
Amber	Standby mode
OFF	OFF

2. Dial key:

- Scroll up/down to select the menu items.

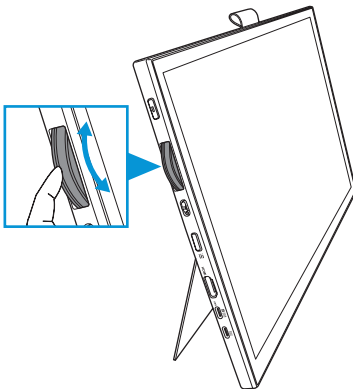

- Press to enter the submenu or confirm the selection.

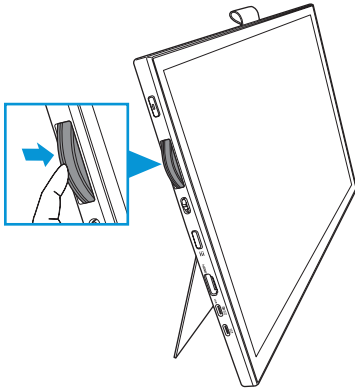

3. Toggle switch:
 - Slide up to allow the Dial key to stepless spin.
 - Slide down to allow the Dial key to clicky spin.
4. Menu button:
 - Enter or exit the OSD menu.
 - Return to the previous OSD menu.

1.3.2 Back view

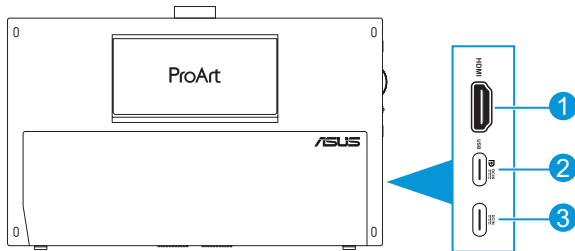

1. **HDMI port:** This port is for connection with an HDMI compatible device.
2. **USB Type-C port:** This port is for connection with a DisplayPort/USB Type-C compatible device. This port is also for connection with a USB upstream cable, which supports Touch and Pen draw functions and firmware updates.



For USB-C DP connection only, the screen brightness is 180nits (typical).

3. **USB Type-C port:** This port connects the adapter.

1.3.3 QuickFit Plus Function

The QuickFit Plus function contains 4 types of patterns: (1) Safe Area (2) Center Marker (3) Customization (4) Ruler. To activate the patterns, press the **Menu** button and select **QuickFit Plus**. Use the Dial key to select a desired pattern.

1. Safe Area

Facilitate designers and users to organize content and layout on one page and achieve a consistent look and feel.

The selections are:



1:1



Action Safe

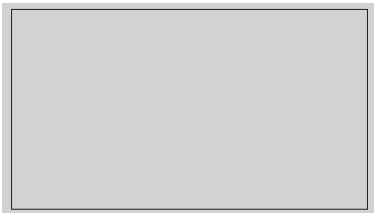

Title Safe

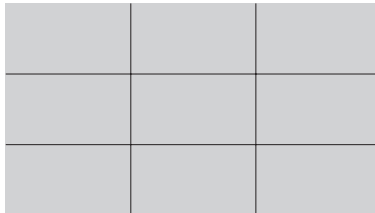

3 x 3

2. Center Marker

Select the center marker type.

The selections are:

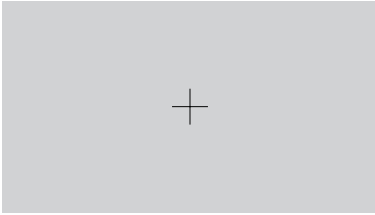

Type 1



Type 2

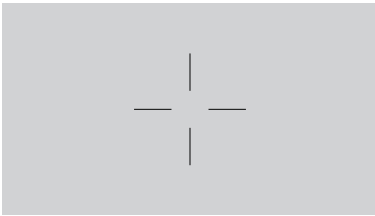

Type 3

3. Customization

You can decide the frame size by scrolling the Dial key up/down. To switch between the horizontal (width) and vertical (height) setting, press the Dial key. Then press the **Power** button to view the frame size and to switch the measurements between metric and imperial.

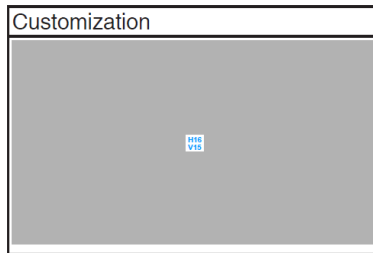

4. Ruler

This pattern presents physical ruler on top and left side. You can press the **Power** button to switch the measurements between metric and imperial.

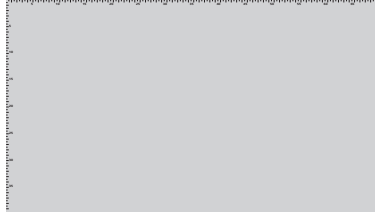

1.3.4 Other Function(s)

1. HDR

The monitor supports HDR format. When detecting HDR content, an “HDR ON” message will pop up and display the Information page.



HDR content is not supported when the PIP/PBP mode is on.

2.1 Adjusting the monitor

- Open the top kick stand to adjust the monitor's angle up to 17°.

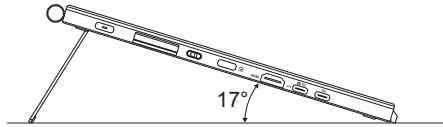

- Open the bottom kick stand to adjust the monitor's angle from 54° ~ 75°.

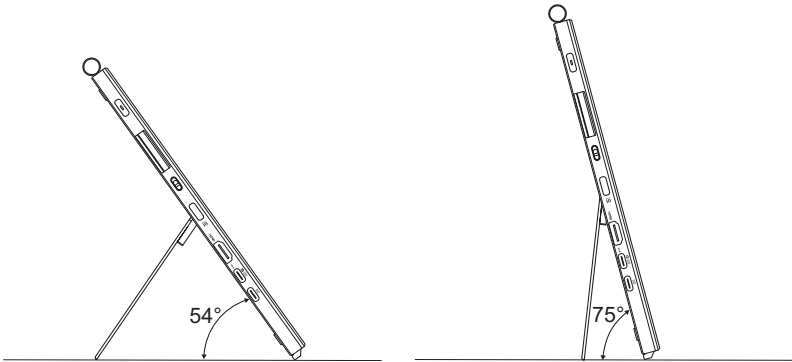

2.2 Connecting the cables

Connect the cables according to the following instructions:

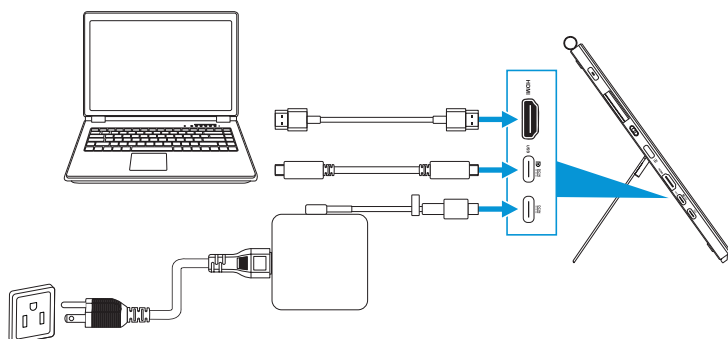

- **To connect the power cable:** Connect the Type-C plug of the adapter to the monitor's USB Type-C port, and connect the 3-pin receptacle of the adapter to the power cord. Then connect the power cord to a power outlet.
- **To connect the HDMI/USB Type-C cable:**
 - a. Plug one end of the HDMI/USB Type-C cable to the monitor's HDMI/USB Type-C port.
 - b. Connect the other end of the HDMI/USB Type-C* cable to your device's HDMI/USB Type-C port.



It is suggested to use USB certified Type-C 4K/ support 4A (or up to 4A) cable. If the signal source supports DP Alt mode, all video, audio and data signal can be transmitted.

- **To use the USB upstream (for Touch / Pen) function:** Use an USB Type-C cable and plug one end of the Type-C connector to the monitor's USB Type-C port as upstream and the other end to your computer's USB Type-C port. Or use an USB Type-C to Type-A cable, plug the Type-C connector to the the monitor's USB Type-C port as upstream and the Type-A connector to your computer's USB Type-A port. Make sure your computer is installed with the latest Windows 10/11 operating system. That will enable the USB ports on the monitor to work.



When these cables are connected, you can choose the desired signal from the Input Select item in the OSD menu.

- **To connect USB Type-C cable only:** Connect the other end of USB Type-C cable from your notebook to PA169CDV Type-C full function port (notebook/devices requires DisplayPort Alt Mode and at least 15W PD power output).

- **To use the Touch screen and Pen functions:**

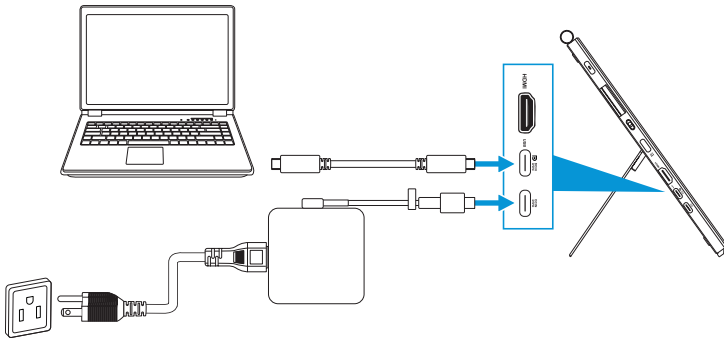

- Enable the **Touch Screen** function in the **Settings** menu. See page 3-10.
- Connect your monitor and the notebook using the USB Type-C cable.



- To use Touch Screen and Pen functions, you need to connect USB Type-C cable to your device for upstream when you using HDMI connection. It is recommended you connect the adapter to achieve the best performance.
- If you only connect the USB Type-C and HDMI cables to your monitor and the notebook, you can still use Touch Screen and Pen functions. However, the screen brightness is 180nits. (When the adapter is not connected, the screen brightness of PA169CDV is only 180nits.)
- If you only connect the adapter and HDMI cable to your monitor and the notebook, the Touch Screen and Pen functions are not working. You still need to connect USB Type-C cable to activate touch / pen function.
- If you only connect the USB Type-C cable to your monitor and the notebook, you can still use Touch Screen and Pen functions. However, the screen brightness is 180nits. (When the adapter is not connected, the screen brightness of PA169CDV is only 180nits. Connected notebook/device requires USB Type-C (DisplayPort Alt Mode and at least 15W power output.))

2.3 Turning on the monitor

Press the **Power** button. See page 1-2 for the location of the **Power** button. The power indicator lights up in white to show that the monitor is ON.

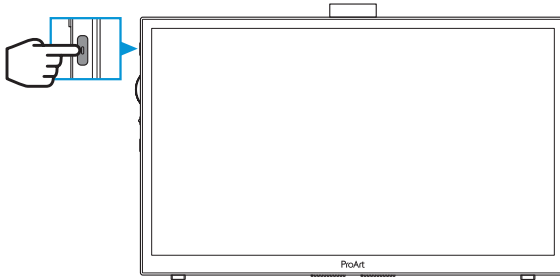

2.4 Touch Operation

This device is a touch monitor which uses 10 point touch panel technology. Please use with latest OS like Windows 10/11.

- You can use either single finger touch, or multi-finger touch up to maximum simultaneous 10 touch points.
Please follow below steps for touch function's first time setup.

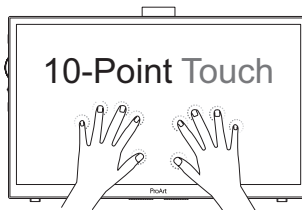
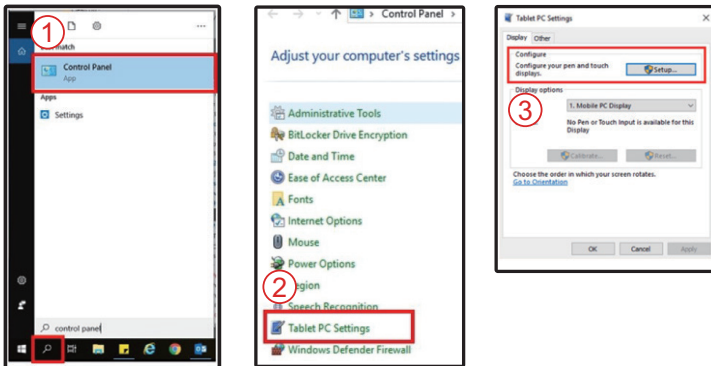

- To activate touch functionality, you need to connect the display with the USB Type-C cable to your computer.
- You do not need to install any other touch driver.
- This device offers you groovy touch gestures like tap, grab, pinch, rotate, zoom, swipe, etc. The gestures allow you to launch programs and access the setting of your device.
- The functions can be activated by using the hand gestures to this device.

3.1 OSD (On-Screen Display) menu

3.1.1 How to reconfigure

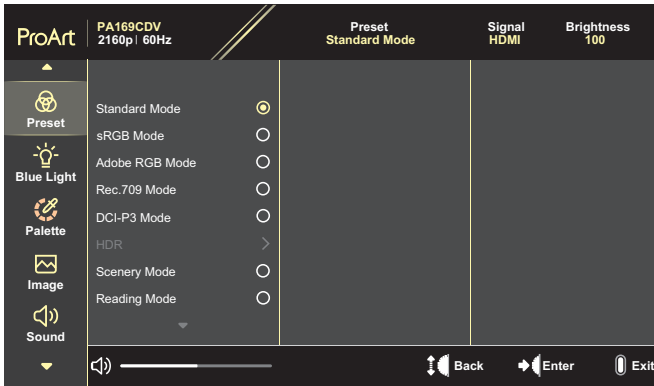

1. Press the **Menu** button to activate the OSD menu.
2. Scroll the Dial key up/down to navigate through the functions. Highlight the desired function and press the Dial key to activate it.
If the function selected has a sub-menu, scroll the Dial key up/down to navigate through the sub-menu functions. Highlight the desired sub-menu function and press the Dial key to activate it.
3. Scroll the Dial key up/down to change the settings of the selected function.
4. To exit and save the OSD menu, press the **Menu** button repeatedly until the OSD menu disappears.
To adjust other functions, repeat steps 1-3.

3.1.2 OSD function introduction

1. ProArt Preset

This function contains 10 sub-functions you can select for your preference. Each mode has the Reset selection, allowing you to maintain your setting or return to the preset mode.

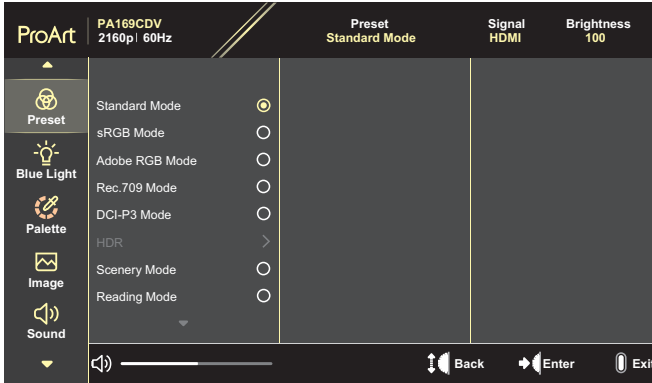

- **Standard Mode:** Best choice for document editing.
- **Adobe RGB Mode:** Compatible with Adobe RGB color space.
- **sRGB Mode:** Compatible with sRGB color space, sRGB is the best choice for web browsing.
- **Rec. 709 Mode:** Compatible with Rec.709 color space.
- **DCI-P3 Mode:** Compatible with DCI-P3 color space.
- **HDR:** Presents ST2084 with DCI-P3 color gamut and D65 white point.
 - » PQ Optimized: Delivers the optimized HDR performance of this display with as much accuracy as with ST2084 in terms of display luminance capability.
 - » PQ Clip: Preserves PQ curve till displaying maximum luminance with accuracy. ST2084 code value with higher than display maximum will be mapped to the maximum luminance.
 - » PQ Basic: Presents HDR performance of general HDR supported displays.
- **Scenery Mode:** Best choice for scenery photo display.
- **Reading Mode:** This is the best choice for book reading.
- **User Mode 1/User Mode 2:** Allow you to make color adjustments in the Advanced Setting.

Below tables show the default configurations for each ProArt Preset mode:

Function	Standard	sRGB	AdobeRGB	Rec 709	DCI-P3
Color Temp.	6500K	Fixed (6500K)	Fixed (6500K)	6500K	P3-Theater
Brightness	50	Fixed 80nits	160nits	100 nits	48nits
Contrast	80	80	80	80	80
Sharpness	Enable (0)	Enable (0)	Enable (0)	Enable (0)	Enable (0)
Saturation	Middle (50)	Disable	Middle (50)	Middle (50)	Middle (50)
Hue	Middle (50)	Disable	Middle (50)	Middle (50)	Middle (50)
ProArtPalette/Color	Enable (default)	Disable	Enable (default)	Enable (default)	Enable (default)
Black Level	Enable (Signal 50)	Enable (Signal 50)	Enable (Signal 50)	Enable (Signal 50)	Enable (Signal 50)
Gamma	Enable (2.2)	Fixed (2.2)	Fixed (2.2)	Enable (2.4)	Enable (2.2/2.6 only)
Input Range	Enable (Auto)	Enable (Auto)	Enable (Auto)	Enable (Auto)	Enable (Auto)
Volume	Enable (Auto)	Enable (Auto)	Enable (Auto)	Enable (Auto)	Enable (Auto)

Function	HDR	Scenery Mode	Reading Mode	User Mode
Color Temp.	Disable (Fixed at 6500K)	Enable (6500K)	Disable	Fixed (6500K)
Brightness	Disable	Enable (100)	Enable	Enable (OSD 50)
Contrast	Disable	80	80	80
Sharpness	Disable	Enable(0)	Enable(0)	Enable (0)
Saturation	Disable	Enable(50)	Disable	Middle (50)
Hue	Disable	Enable(50)	Disable	Middle (50)
ProArt Palette/Color	Disable	Enable	Enable	Enable (RGB Gain only)
Black Level	Disable	Enable (Signal 50)	Enable (Signal 50)	Enable (Signal 50)
Gamma	Disable	Disable	Enable (2.2)	Fixed (2.2)
Input Range	Disable	Disable	Disable	Disable
Volume	Enable (Auto)	Enable (Auto)	Enable (Auto)	Enable (Auto)

Select Standard Mode to support Energy Star energy-saving

This product complied with ENERGY STAR.

The default as shipped displays configuration and settings are compliance with ENERGY STAR, and are recommended by the ENERGY STAR program for optimal energy savings.

Note: enabling certain optical features and functionalities (e.g., instant-on), may increase energy consumption beyond the limits required for ENERGY STAR certification, as applicable.

2. Blue Light Filter

Adjust the blue light filter level.

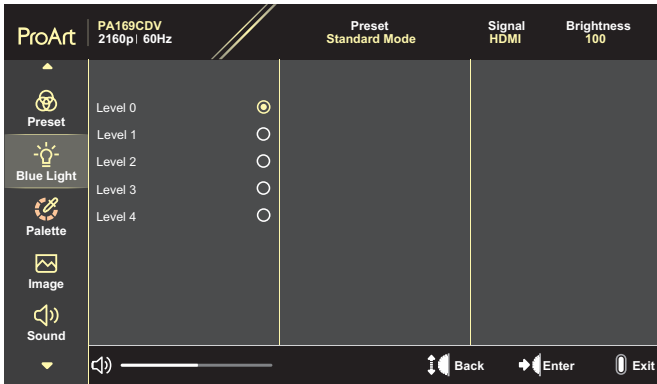

- **Level 0:** No change.
- **Level 1~4:** The higher the level, the less blue light is scattered. When Blue Light Filter is activated, the default settings of Standard Mode will be automatically imported. Between Level 1 to Level 3, the Brightness function is user-configurable. Level 4 is optimized setting. It is compliance with TUV Low Blue Light Certification. The Brightness function is not user-configurable.



Please refer to the following to alleviate eye strains:

- Users should take some time away from the display if working for long hours. It is advised to take short breaks (at least 5 mins) after around 1 hour of continuous working at the computer. Taking short and frequent breaks is more effective than a single longer break.
- To minimize eye strain and dryness in your eyes, users should rest the eye periodically by focusing on objects that are far away.
- Eye exercises can help to reduce eye strain. Repeat these exercises often. If eye strain continues please consult a physician. Eye exercises: (1) Repeating look up and down (2) Slowly roll your eyes (3) Move your eyes diagonal.
- High energy blue light may lead to eye strain and AMD (Age-Related Macular Degeneration). Blue light Filter to reduce 70% (max.) harmful blue light to avoiding CVS (Computer Vision Syndrome).



Protect your eyes with ASUS EYE CARE Monitors.

The latest ASUS monitors feature exclusive Blue Light Filter and Flicker free technologies to keep your eyes healthy.

Refer to https://www.asus.com/Microsite/display/eye_care_technology/.

3. ProArt Palette

Set a desired color setting from this menu.

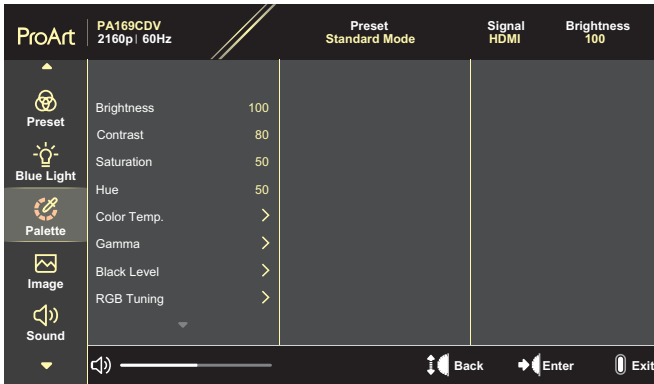

- **Brightness:** The adjusting range is from 0 to 100.



When the HDR function is enabled, the maximum brightness level is automatically set to 400nits as default.

- **Contrast:** The adjusting range is from 0 to 100.
- **Saturation:** The adjusting range is from 0 to 100.
- **Hue:** Shift the image color between green and purple.
- **Color Temp.:** Contain 5 modes including 9300K, 6500K, 5500K, 5000K, and P3-Theater.



When the ProArt Preset setting is set to DCI-P3 Mode, only 6500K and P3-Theater options are available.

- **Gamma:** Allow you to set the color mode to 1.8, 2.0, 2.2, 2.4, or 2.6.
- **Black Level:** Adjust the initialized 1st signal level of darkest gray level.
- **RGB Tuning:** Configure the color settings.
 - » Gain: Adjust the gain levels for the red, green, or blue color.
 - » Offset: Adjust the black level offset values for the red, green, or blue color.

- **Color Reset:** Reset the color related settings.
 - » Current mode color reset:
Reset the color settings of the current color mode to the factory default value.
 - » All modes color reset:
Reset the color settings of all color modes to the factory default value.

4. Image

Set the image related setting from this menu.

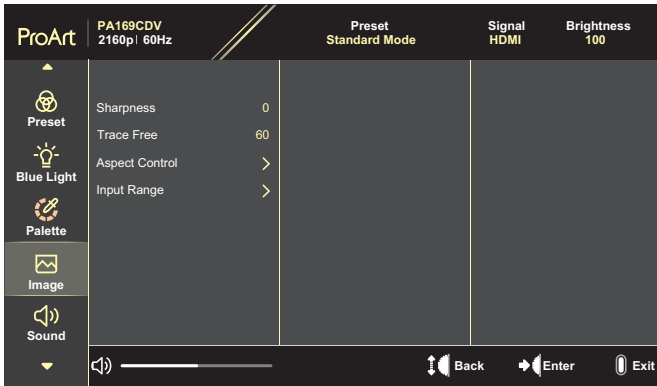

- **Sharpness:** The adjusting range is from 0 to 100.
- **Trace Free:** Adjust the response time of the monitor.
- **Aspect Control:** Adjust the aspect ratio to Full, 4:3, 1:1, or OverScan.

 - To activate this function, you need to do the following: turn off the PBP mode.
 - 4:3 is only available when input source is in 4:3 format. OverScan is only available for the HDMI input source.
- **Input Range:** Adjust the input range to Auto, Full, or Limited 16-235.

5. Sound

Configure the sound settings.

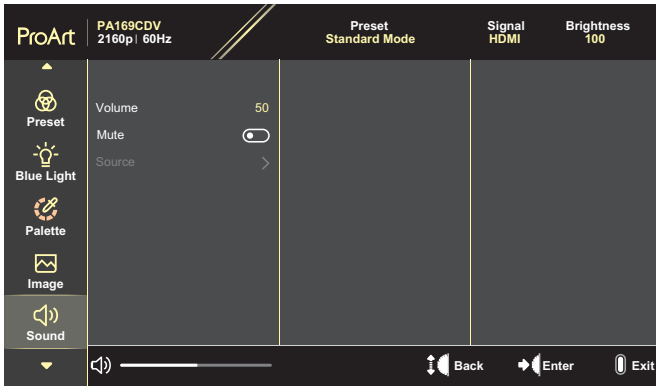

- **Volume:** Adjust the output volume level.
- **Mute:** Enable or disable the mute function.
- **Source:** Specify the monitor sound comes from which source.



To activate this function, you need to enable the PIP/PBP mode.

6. PIP/PBP Setting

The PIP/PBP Setting allows you to open up another sub-window connected from another video source besides the main-window from your original video source. By activating this function, the monitor displays up to 2 pictures from different video sources.



To activate this function, you need to disable the HDR function.

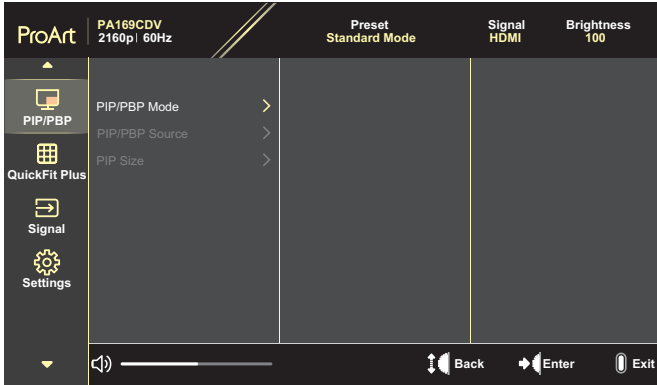

- **PIP/PBP Mode:** Select PIP, PBP, or turn it off.
- **PIP/PBP Source:** Select the video input source between HDMI and USB Type-C.
- **PIP Size:** Adjust the PIP size to Small, Middle, or Large. (Only available for the PIP mode)

7. QuickFit Plus

Allow users to have a preview of the document or photo layout directly on the screen without printing the test copies.



To activate this function, you need to disable the PIP/PBP mode.

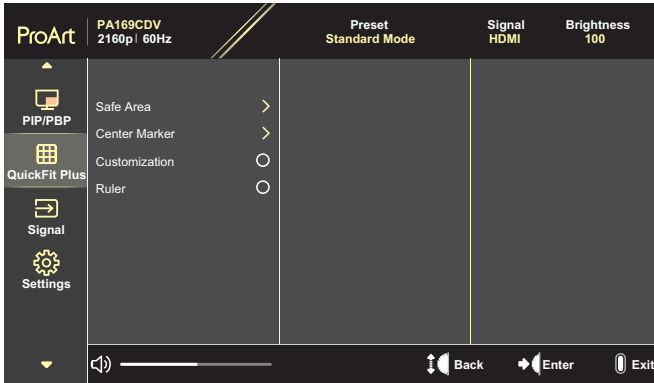

- **Safe Area:** Facilitate designers and users to organize content and layout on one page and achieve a consistent look and feel. The selections are: 1:1, Action Safe, Title Safe, or 3 x 3.
- **Center Marker:** Select the center marker type. The selections are: Type 1, Type 2, or Type 3.
- **Customization:** You can decide the frame size by scrolling the Dial key up/down. To switch between the horizontal (width) and vertical (height) setting, press the Dial key. Then press the **Power** button to view the frame size and to switch the measurements between metric and imperial.
- **Ruler:** This pattern presents physical ruler on the top and left sides. You can press the **Power** button to switch the measurements between metric and imperial.

8. Signal

In this function, you can select your desired input source.

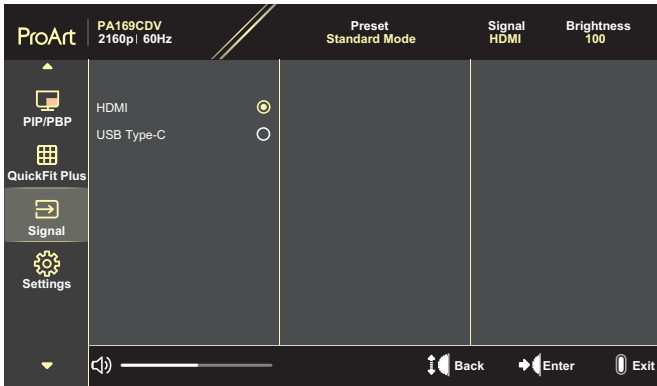

9. Settings

Allow you to adjust the system.

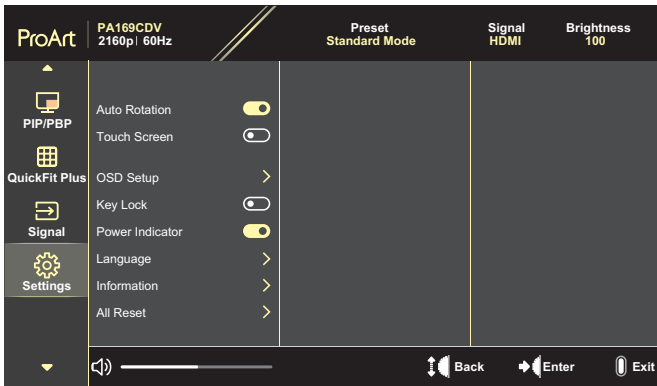

- **Auto Rotation:** Enable or disable the automatic OSD rotation function.
- **Touch Screen:** Enable or disable the touch screen function.
- **OSD Setup:** Configure the OSD menu settings.
 - » OSD Timeout: Adjust the OSD timeout from 10 to 120 seconds.
 - » Transparency: Adjust the OSD background from opaque to transparent.
- **Key Lock:** Select “On” to disable the **Power** and **Menu** buttons. To cancel the Key Lock function, press the **Menu** button for more than five seconds.
- **Power Indicator:** Turn the power LED indicator on/off.
- **Language:** Select the OSD menu language.

- **Information:** Show the monitor information.
- **All Reset:** Select “Yes” to revert all settings to the factory default mode.

3.2 Specifications Summary

Panel Type	IPS LCD Panel
Panel Size	15.6"
Max. Resolution	3840 x 2160
Pixel Pitch	0.09 (H) x 0.09 (V) mm
Brightness	450 cd/m ² (typ.) / VESA DisplayHDR 400
Contrast Ratio	1200 (typ.)
Viewing Angle (H/V) CR>10	178° (H) / 178° (V)
Display Colors	1.07 Billion (10 bit)
Response Time	29ms (Tr to Tf)
ProArt Preset Selection	10 color preset modes (2 user modes included)
Color Temperature Selection	5 color temperatures
ASUS ProArt Pen	Wacom EMR solution
Touch	10 points touch
Auto Rotation	Gyro-sensor
Digital Input	HDMI 2.0, USB Type-C
Power LED	White (On) / Amber (Standby)
Tilt	Yes
AC input voltage	100~240V
Power consumption	Power on: 15W (typ.) Sleep mode: < 0.5W Off: < 0.3W
Temperature (Operating)	0°C ~ 40°C
Temperature (Non-operating)	-20°C ~ +60°C
Phys. Dimension with Stand (W x H x D)	370.2 x 237.2 x 12.1 mm
Box Dimension (W x H x D)	539 x 107.5 x 323 mm
Net Weight (Esti.)	1.07 kg
Gross Weight (Esti.)	2.95 kg
Multi-languages	22 Languages
Accessories	Carry bag, Calibration report, Quick start guide, Warranty card, Power cable, Adapter (model: ADP-65SD, input: AC100-240V ~ 50-60Hz 1.5A, output: 20V --- 3.25A 65W or 15V/9V/5V --- 3A 15W), HDMI cable, USB Type-C cable, ProArt pen, Pen nibs and tweezers

Compliance and Standards

ES8.0, ErP, UL/cUL, CB, CE, FCC, BSMI, VCCI, J-MOSS, RoHS, WEEE, Windows 10&11 WHQL, CCC, e-Standby, UL/CUL, type C (DP alt), TÜV Flicker free, TÜV low blue light, VESA DisplayHDR 400

***Specifications are subject to change without notice.**

3.3 Outline dimensions

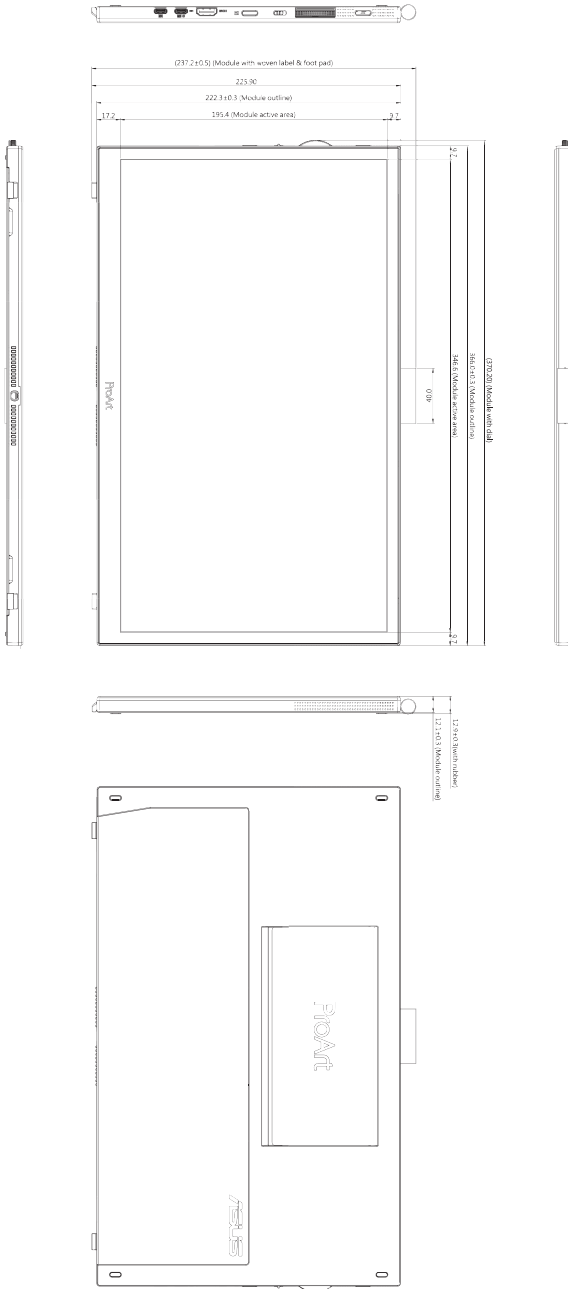

3.4 Troubleshooting (FAQ)

Problem	Possible Solution
Power LED is not ON	<ul style="list-style-type: none">• Press the Power button to check if the monitor is in the ON mode.• Check if the power cable and adapter are properly connected to the monitor and the power outlet.
The power LED lights amber and there is no screen image	<ul style="list-style-type: none">• Check if the monitor and the computer are in the ON mode.• Make sure the signal cable is properly connected the monitor and the computer.• Inspect the signal cable and make sure none of the pins are bent.• Connect the computer with another available monitor to check if the computer is properly working.
Screen image is too light or dark	<ul style="list-style-type: none">• Adjust the Contrast and Brightness settings via OSD.
Screen image bounces or a wave pattern is present in the image	<ul style="list-style-type: none">• Make sure the signal cable is properly connected to the monitor and the computer.
Screen image has color defects (white does not look white)	<ul style="list-style-type: none">• Inspect the signal cable and make sure that none of the pins are bent.• Perform All Reset via OSD.• Adjust the RGB Tuning settings or select the Color Temperature (Color Temp.) via OSD.
No sound or sound is low	<ul style="list-style-type: none">• Ensure that the HDMI cable is properly connected to the monitor and the computer.• Adjust the volume settings of both your monitor and HDMI device.• Ensure that the computer graphic card driver is properly installed and activated.

3.5 Supported operating modes

Resolution	Vertical Frequency (Hz)
640x480	59.94(N)
720x480	59.94
720x576	50
800x600	56(P)
800x600	60(P)
1024x768	60(N)
1280x720	60
1280x960	60(N)
1280x1024	60(P)
1440x900	60(P)
1600x1200	60(P)
1680x1050	60(P)
1920x1080	60(P)
1920x1200	59.885(P)
2560x1440	59.9(N)
3840x2160	23.98(P)
3840x2160	25
3840x2160	29.97(P)
3840x2160	50(P)
3840x2160	60(N)

“P” / “N” stands for “Positive” / “Negative” polarity of incoming H-sync/V-sync (input timing).
 When the monitor is operating in the video mode (ie, not displaying data) using the HDMI connector, the following high definition modes shall be supported in addition to standard definition video.