

VPC33/VPC35/VPC37 VS19693 Slot in PC module

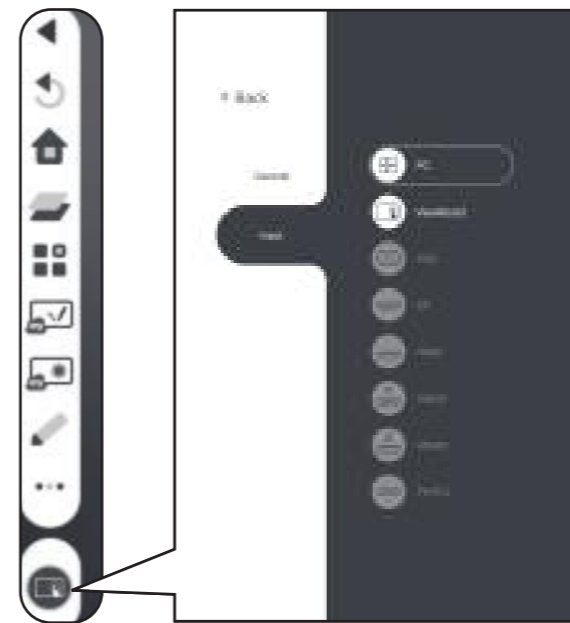

IFP Series

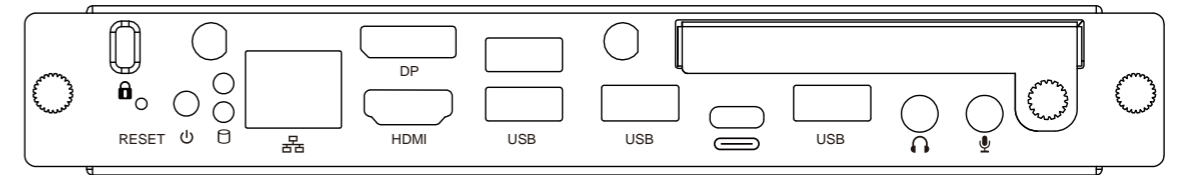
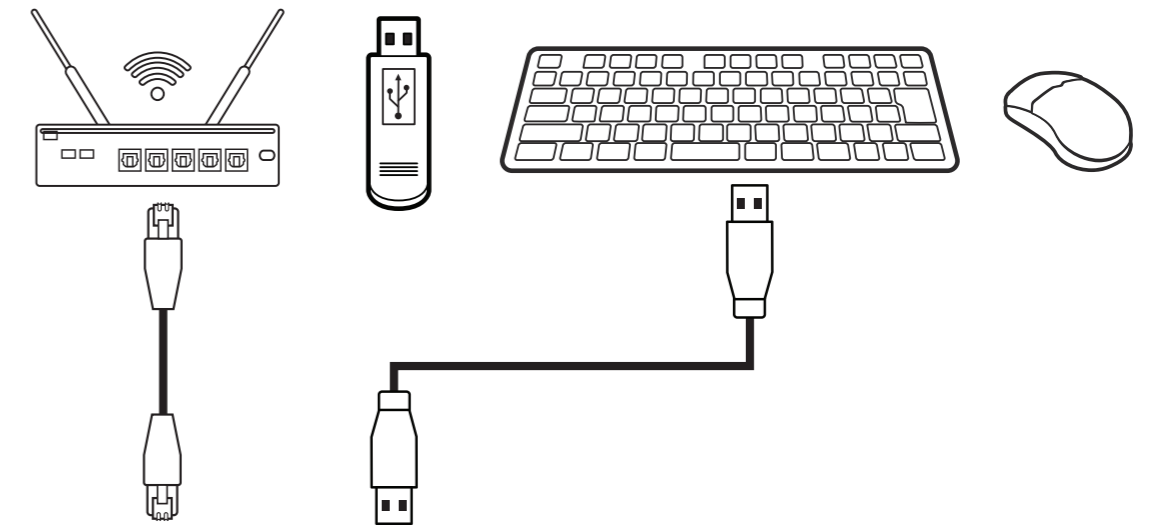
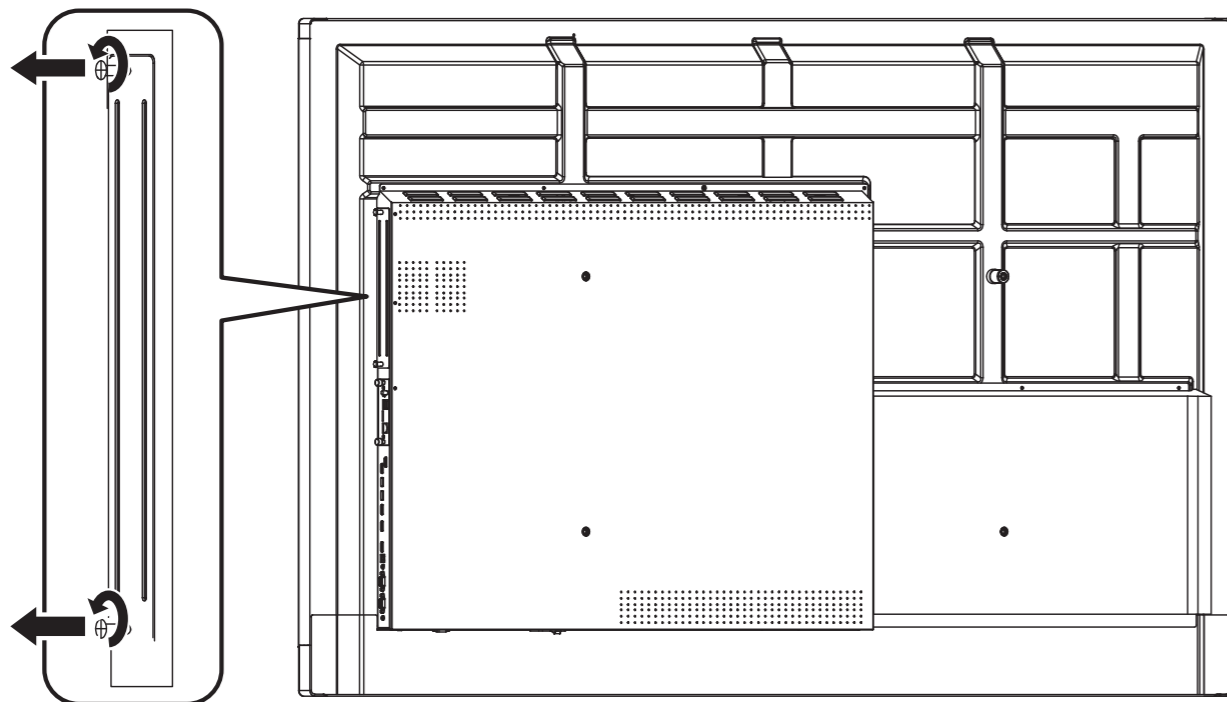
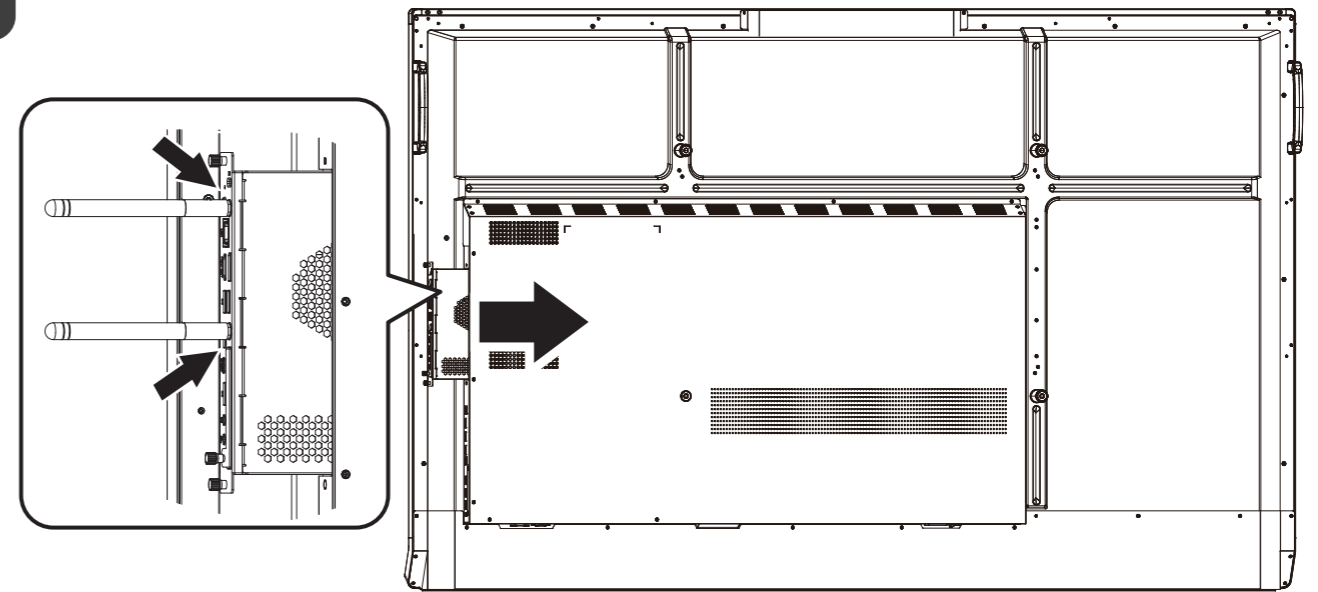
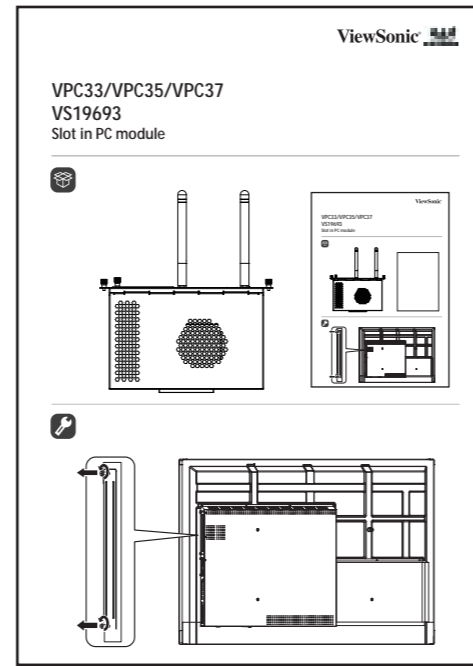
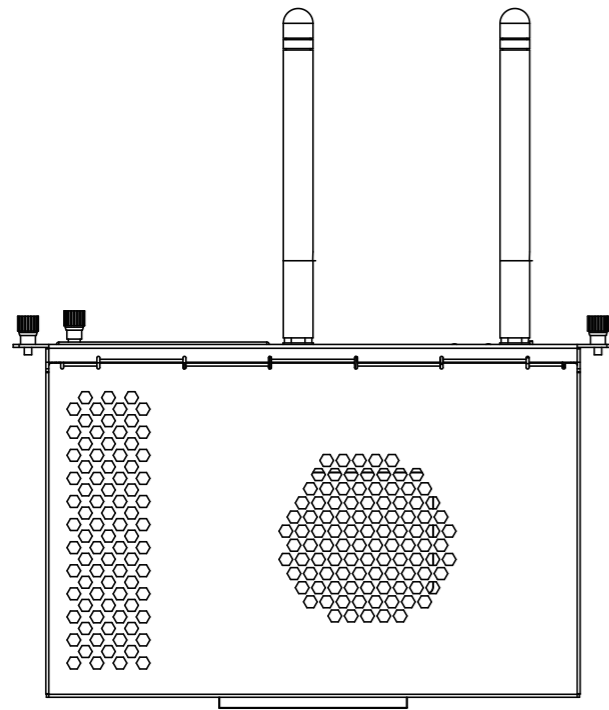

CDE Series



FCC Compliance Statement

This device complies with part 15 of FCC Rules. Operation is subject to the following two conditions: (1) this device may not cause harmful interference, and (2) this device must accept any interference received, including interference that may cause undesired operation.

Industry Canada Statement

CAN ICES-003(B) / NMB-003(B)

Contains FCC ID:
IC ID:

CE Conformity for European Countries

CE The device complies with the EMC Directive 2014/30/EU and Low Voltage Directive 2014/35/EU and Radio Equipment Directive (RED) 2014/53/EU.
https://www.viewsonicglobal.com/public/products_download/safety_compliance/acc/VS19693_CE_DOC.pdf

FCC-Hinweise

Dieses Gerät erfüllt alle Anforderungen des Teils 15 der FCC-Bestimmungen. Der Betrieb muss die folgenden zwei Bedingungen erfüllen: (1) Das Gerät darf keine schädlichen Interferenzen verursachen, und (2) das Gerät muss alle empfangenen Interferenzen inklusive der Interferenzen, die eventuell einen unerwünschten Betrieb verursachen, annehmen.

Industry Canada-Hinweis

CAN ICES-003(B) / NMB-003(B)

Contains FCC ID:
IC ID:

CE-Konformität für europäische Länder

CE Das Gerät erfüllt die Anforderungen der EMV-Richtlinie 2014/30/EU und der Niederspannungsrichtlinie 2014/35/EU und Funkgeräte-Richtlinie 2014/53/EU.
https://www.viewsonicglobal.com/public/products_download/safety_compliance/acc/VS19693_CE_DOC.pdf

Overensstemmelseserklæring fra FCC

Denne enhed overholder stk. 15 i FCC-reglerne. Driften er underlagt følgende to betingelser: (1) Denne enhed må ikke forårsage skadelig interferens, og (2) denne enhed skal acceptere enhver modtaget interferens, herunder interferens, der kan forårsage uønsket drift.

Erklæring fra Industry Canada

CAN ICES-003(B) / NMB-003(B)

Indeholder FCC ID:
IC ID:

CE-overensstemmelse for europæiske lande

CE Enheden er i overensstemmelse med EMC-direktivet 2014/30/EU og lavspændingsdirektivet 2014/35/EU og direktivet om radioustyret (RED) 2014/53/EU.
https://www.viewsonicglobal.com/public/products_download/safety_compliance/acc/VS19693_CE_DOC.pdf

FCC-nalevingsverklaring

Dit apparaat voldoet aan Deel 15 van de FCC-voorschriften. Gebruik is onderworpen aan de volgende twee voorwaarden: (1) dit apparaat mag geen schadelijke ruis veroorzaken en (2) dit apparaat dient ontvangen ruis te accepteren, inclusief ruis die ongewenste werking kan veroorzaken.

Verklaring voor Canadese bedrijven

CAN ICES-003(B) / NMB-003(B)

Bevat FCC ID:
IC ID:

CE-verklaring van conformiteit voor Europese landen

CE Het apparaat voldoet aan de EMC-richtlijn 2014/30/EU en Laagspanningsrichtlijn 2014/35/EU en Richtlijn betreffende radio-apparatuur (RED) 2014/53/EU.
https://www.viewsonicglobal.com/public/products_download/safety_compliance/acc/VS19693_CE_DOC.pdf

Declaración de conformidad de la FCC (Comisión Federal de Comunicaciones)

Este dispositivo cumple con el Apartado 15 de las normas FCC. El funcionamiento está sujeto a las dos condiciones siguientes: (1) Este dispositivo no debe causar interferencias perjudiciales, y (2) Este dispositivo debe aceptar cualquier interferencia recibida, incluidas aquellas que provoquen un funcionamiento no deseado.

Declaración del Departamento de Industria de Canadá

CAN ICES-003(B) / NMB-003(B)

Contains FCC ID:
IC ID:

Certificación CE para países europeos

CE Este dispositivo cumple con la Directiva EMC (Compatibilidad Electromagnética) 2014/30/EU y la Directiva de Baja Tensión 2014/35/ EU y Directiva para equipos de radio 2014/53/UE.
https://www.viewsonicglobal.com/public/products_download/safety_compliance/acc/VS19693_CE_DOC.pdf

FCC-yhdenmukaisuusilmoitus

Laitte on FCC-sääntöjen osan 15 mukainen. Laitteen käyttöä koskevat seuraavat kaksi ehtoa: (1) tämä laite saattaa aiheuttaa haitallista häiriötä, ja (2) tämän laitteen tulee vastaanottaa siihen tuleva häiriö, mukaan lukien häiriöt, joka voivat aiheuttaa ei-toivottuja toimintoja.

Industry Canada -ilmoitus

CAN ICES-003(B) / NMB-003(B)

Sisältö FCC ID:
IC ID:

CE-yhdenmukaisuus Euroopan maissa

CE Tämä laite on EMC-direktiivin 2014/30/EU ja matalajännittdirektiivin 2014/35/EU ja radiolaittdirektiivin (RED) 2014/53/EU vaatimusten mukainen.
https://www.viewsonicglobal.com/public/products_download/safety_compliance/acc/VS19693_CE_DOC.pdf

Declaration de conformite FCC

Cet appareil est conforme à l'article 15 des Règlements FCC. Son fonctionnement est sujet aux deux conditions suivantes: (1) Cet appareil ne doit pas provoquer d'interférences néfastes, et (2) cet appareil doit accepter toutes les interférences reçues, y compris celles pouvant provoquer un fonctionnement indésirable.

Declaration de l'Industrie canadienn

CAN ICES-003(B) / NMB-003(B)

Contains FCC ID:
IC ID:

Conformité CE pour les pays européens

CE L'appareil est conforme la norme EMC 2014/30/EU et à la norme sur la basse tension 2014/35/EU et directive Équipements radioélectriques 2014/53/UE.
https://www.viewsonicglobal.com/public/products_download/safety_compliance/acc/VS19693_CE_DOC.pdf

Δήλωση συμμόρφωσης με την FCC

Η παρούσα συσκευή συμμορφώνεται με το Μέρος 15 των κανόνων της Επιτροπής FCC. Η λειτουργία υπόκειται στους εξής δύο όρους: (1) αυτή η συσκευή δεν μπορεί να προκαλέσει επιβλαβή παρεμβολή, και (2) αυτή η συσκευή πρέπει να αποδέχεται οποιαδήποτε παρεμβολή, συμπεριλαμβανομένης παρεμβολής που μπορεί να προκαλέσει ανεπιθύμητη λειτουργία.

Δήλωση Industry Canada

CAN ICES-003(B) / NMB-003(B)

Περιέχει FCC ID:
IC ID:

Συμμόρφωση CE για τις Ευρωπαϊκές χώρες

CE Η συσκευή συμμορφώνεται με την Οδηγία EMC 2014/30/EE, την Οδηγία περί χαμηλής τάσης 2014/35/EE και την Οδηγία για τον ραδιοεξοπλισμό (RED) 2014/53/EE.
https://www.viewsonicglobal.com/public/products_download/safety_compliance/acc/VS19693_CE_DOC.pdf

FCC-samsvarserklæring

Denne enheten samsvarer med del 15 i FCC-reglene. Bruk er underlagt følgende to betingelser: (1) Denne enheten skal ikke forårsake skadelig interferens, og (2) denne enheten må godta all mottatt interferens, inkludert interferens som kan forårsake uønsket drift.

Industry Canada-erklæring

CAN ICES-003(B) / NMB-003(B)

Inneholder FCC ID:
IC ID:

CE-samsvar for europeiske land

CE Enheten samsvarer med EMC-direktivet 2014/30/EU, Lavspenningsdirektivet 2014/35/EU og Radioutstyrsdirektivet (RED) 2014/53/EU.
https://www.viewsonicglobal.com/public/products_download/safety_compliance/acc/VS19693_CE_DOC.pdf

Declaração de conformidade da FCC

Este dispositivo está em conformidade com o Artigo 15º das Normas da FCC. O seu funcionamento está sujeito às duas condições seguintes: (1) este dispositivo não poderá causar interferências prejudiciais, e (2) este dispositivo deve aceitar quaisquer interferências recebidas, incluindo interferências que possam causar um funcionamento indesejado.

Declaração do Departamento de indústria do Canadá

CAN ICES-003(B) / NMB-003(B)

Contém FCC ID:
IC ID:

Conformidade CE para países europeos

CE O dispositivo cumpre a Diretiva CEM 2014/30/UE e a Diretiva de Baixa Tensão 2014/35/UE e a Diretiva de Equipamentos de Rádio (RED) 2014/53/UE.
https://www.viewsonicglobal.com/public/products_download/safety_compliance/acc/VS19693_CE_DOC.pdf

Соответствие требованиям Федеральной комиссии по связи США (FCC)

Данное устройство соответствует требованиям Части 15 Правил FCC. Работа должна соответствовать следующим двум условиям: (1) данные устройства не могут являться источниками вредных помех, и (2) данные устройства должны работать в условиях помех, включая те, которые могут вызывать сбои в работе.

Соответствие требованиям Министерства промышленности Канады

CAN ICES-003(B) / NMB-003(B)

Contains FCC ID:
IC ID:

Соответствие стандартам ЕС для европейских стран

CE Данное устройство соответствует требованиям Директивы 2014/30/ЕС на электромагнитную совместимость и Директиве 2014/35/ЕС на низковольтное оборудование и Директива о радиооборудовании 2014/53/ЕС.

https://www.viewsonicglobal.com/public/products_download/safety_compliance/acc/VS19693_CE_DOC.pdf

Uttalande gällande FCC-efterlevnad

Denna enhet överensstämmer med avsnitt 15 i FCC-reglerna. Användningen är underställd följande två villkor: (1) Enheten får inte orsaka skadliga störningar och (2) Denna enhet måste acceptera alla mottagna störningar, inklusive störningar som kan orsaka oönskad funktion.

Uttalande från Industry Canada

CAN ICES-003(B) / NMB-003(B)

Innehåller FCC ID:
IC ID:

CE-överensstämmelse för europeiska länder

CE Enheten överensstämmer med EMC-direktivet 2014/30/EU, lågspänningsdirektivet 2014/35/EU och direktivet om radioutrustning (RED) 2014/53/EU.
https://www.viewsonicglobal.com/public/products_download/safety_compliance/acc/VS19693_CE_DOC.pdf

FCC Uyumluluk Bildirimi

Bu aygıt, FCC Kuralları kısım 15'e uygundur. Kullanım aşağıdaki iki koşula bağlıdır: (1) Bu aygıt zararlı girişime neden olamaz ve (2) bu aygıt istenmeyen çalışmaya neden olabilen girişim dahil olmak üzere alınan her türlü girişimi kabul etmelidir.

Industry Canada Bildirimi

CAN ICES-003(B) / NMB-003(B)

İçindekiler FCC ID:
IC ID:

Avrupa Ülkeleri İçin CE Uyumluluğu

CE Aygıt, EMC Yönergesi 2014/30/EU ve Düşük Voltaj Yönergesi 2014/35/EU'ya uygundur ve Radyo Ekipman Direktifi 2014/53/AB.

https://www.viewsonicglobal.com/public/products_download/safety_compliance/acc/VS19693_CE_DOC.pdf



www.viewsonic.com

VPC33_VPC35_VPC37_QSG_1a_20230508
Copyright © 2023 ViewSonic Corporation. All rights reserved.