

msi

PRO DP10 13M

Business & Productivity PC

Infokit

Be Your Window To The World



Tech meets Aesthetic



PRO DP10 Series

Be Your Window To The World

Business & Productivity Desktop PC

Pro

Compact yet Powerful Business Center

Take a huge leap in performance and experience a boosted and faster rendering for the applications in this compact yet powerful business center that you work everyday.



185.5 mm



1.1 Liter

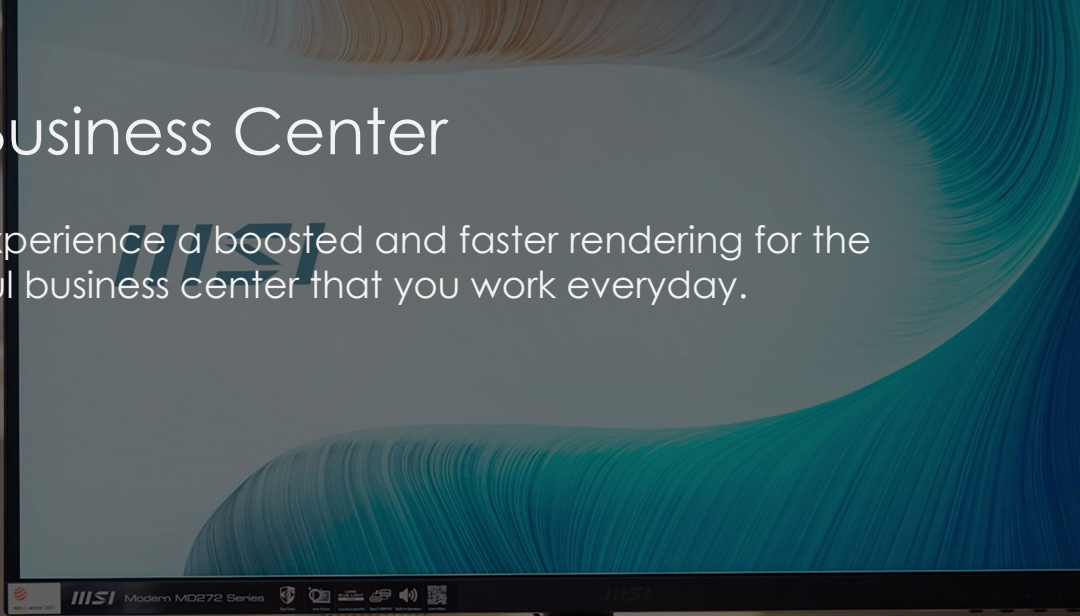

13th Gen CPU



Thunderbolt™ 4



4-Display Support

PRO DP10 Series

Stable and Powerful

msi

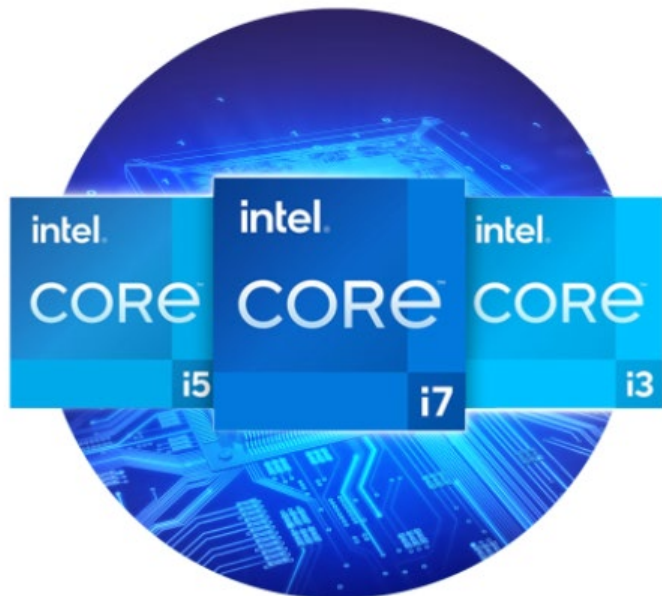

Up to

Core i7-1360P

With 12 Cores

Up to

64GB

Dual Channel Memory

Support

Windows 11 Pro

Equips up to 13th Gen Intel® Core™ i7 processor with 12 cores and 16 threads, delivering computing capability and keeping you in the flow, wherever you go. Also, enjoy more detailed, immersive viewing experience with Intel® Iris® Xe Graphics.

HDMI™
High-Definition Multimedia Interface

DisplayPort



Thunderbolt™ 4

D-sub (VGA)



Bolt To The Next Power

Built-in Thunderbolt 4

Up to

40Gbps

Data Transmission Speed

8K

Display

Up to 4 Displays with Thunderbolt

With one Thunderbolt, one DP-out, one HDMI-out, and a VGA port (D-sub), PRO DP10 Series allow you to extend up to 4 monitors to pre-view your programming, E-commerce content & data at home or in the office.

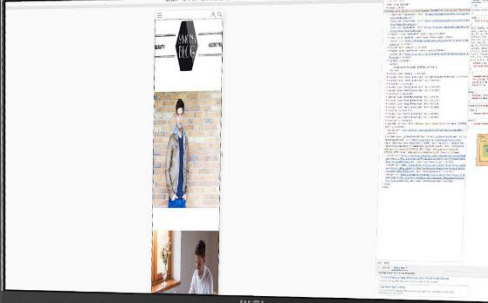
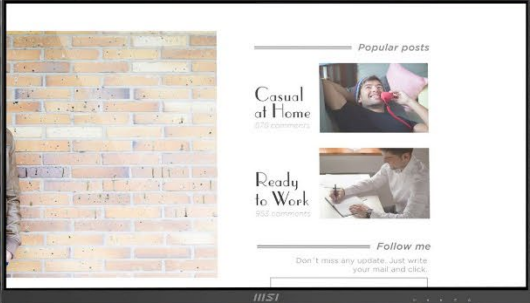
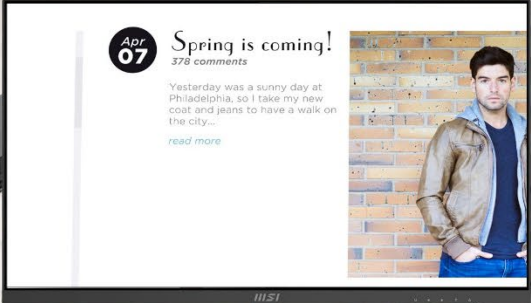
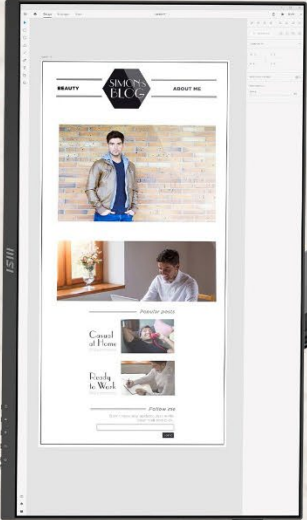

PRO DP10 Series

Reversible Type-C With USB 3.2 Gen 2

When backup your projects at home, you can get all the performance benefits from USB 3.2 Gen 2, combined with the convenience of the reversible USB Type-C connector port.



Wi-Fi 6E: Connect All of Your Creative Devices

Wi-Fi 6E puts more emphasis on transmission security and improves the signal between the interference problem can also be connected to more devices simultaneously, thereby meeting the trend of higher and higher data transmission bandwidth requirements with speeds up to 2.4Gbps.

Up to

3x

Faster Gigabit
Speeds

Up to

75%

Lower Latency

Support

MU-MIMO

Protocols



Transfer Files & Work with 2.5G LAN

Connect and rapidly transfer data over a network with the high-bandwidth and low-latency 2.5Gbps Ethernet LAN.

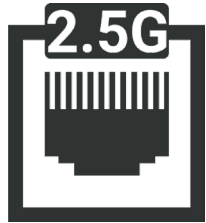



MSI Cloud Center

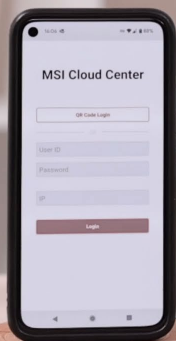

MSI

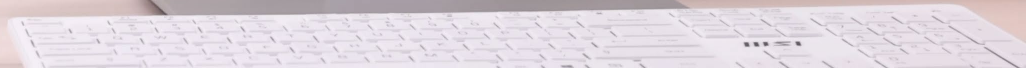

How to use MSI Cloud Center – Basic Steps

1. Connect to same WiFi (Intranet)

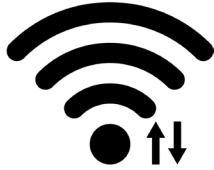

2. Download & install MSI Cloud Center App for AIO, DT, Android, and iOS devices



MSI Cloud Center
Landing page



3. Scan QR code to log in

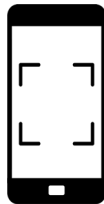

MSI Cloud Center – Key Features



msi

Cross Platform

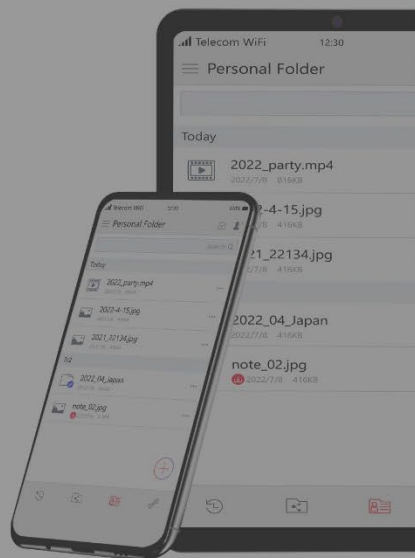

Backup, download, share files between your PC, Android, and iOS devices.

QR Code Login



Easily & instantly log in with a QR code in seconds generated by the MSI Cloud Center.

Fast & Secure



Wirelessly and promptly upload photos, video, and any files within a private intranet environment.

Private Cloud

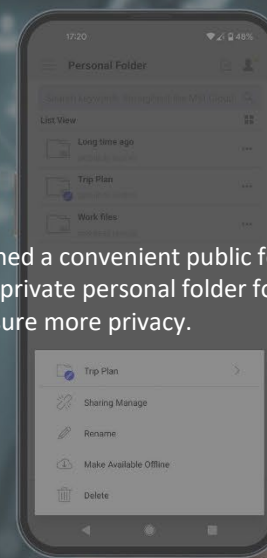

Designed a convenient public folder and a private personal folder for you to ensure more privacy.

Share data with team members or make files as private as you want, the decision is in your hands.

Convenient Auto-Backup



Just one click and the MSI Cloud Center will automatically backup all of your photos & videos to the specific storage you want.

You can choose to upload all of the photos or videos separately, the decision is in your hand.

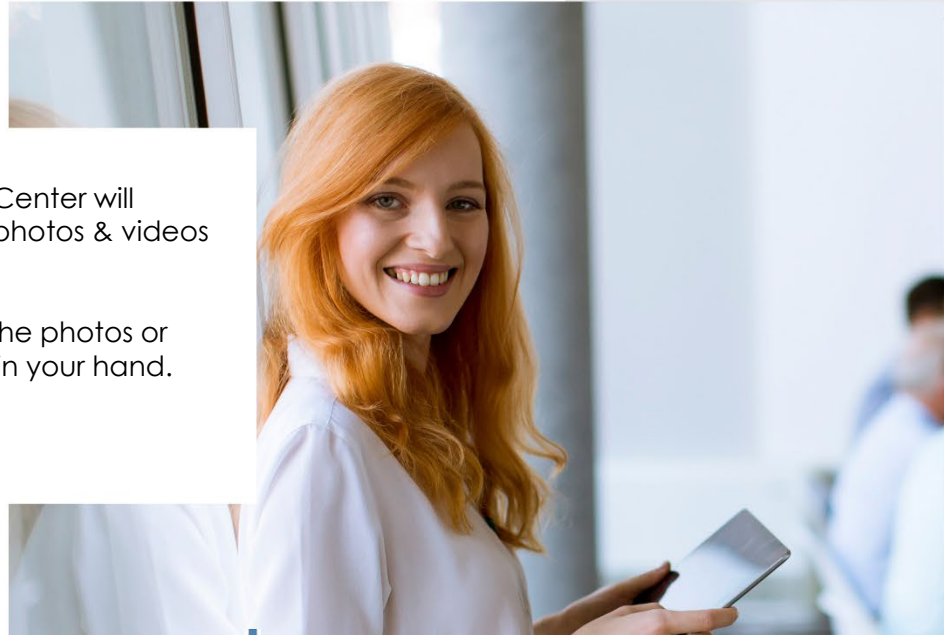

Multiple Files Selecting



You can select multiple files at once, the MSI Cloud Center supports multi-file uploading and downloading as well, this brings you the most convenient & efficient way to backup files.



Multiple Devices/ Storages Support

The MSI Cloud Center can fast pair with multiple devices, and switch between them easily.

You can switch from your PC to other MSI PCs which you have logged in with its unique QR code.

You can upload, download, delete or even share the files with your family or team members who have been authorized & logged in with a QR code generated by the MSI Cloud Center, and they will also enjoy all of the benefit of Your Private Cloud or Home Cloud.

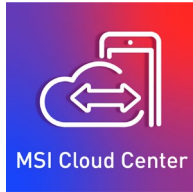

Share To The World

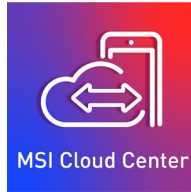

Through the applications installed on the smartphone, you can share any data, photos, or videos which have been backup to the MSI Cloud Center to the world.



MSI Center

msi

The MSI Center takes optimization to the next level with A.I.; it helps to prioritize & allocate the resource on your hand to accelerate the performance of those software which you work with everyday.

It also helps you to find the photos or materials with Tag and brings the most efficient experience for your daily works.

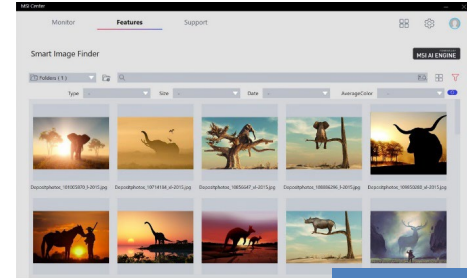
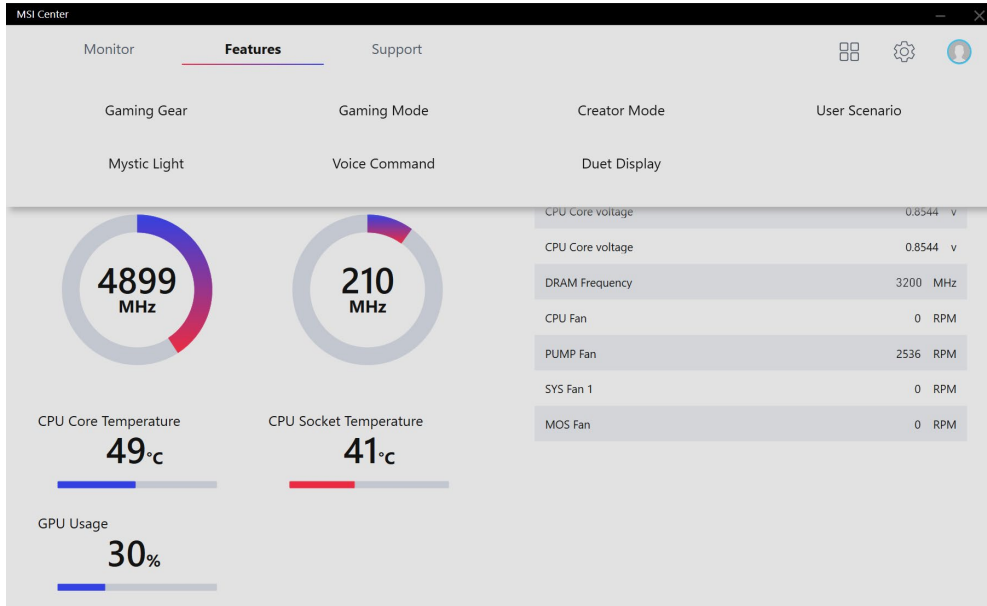

Smart Image Finder

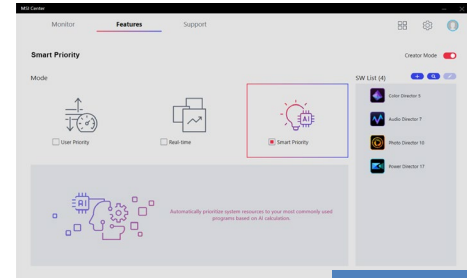

Smart Priority

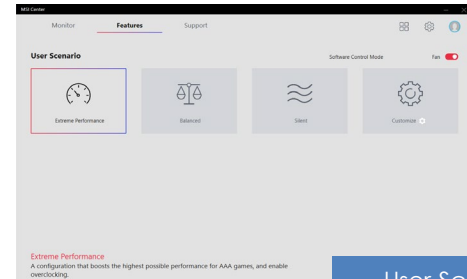

User Scenario

Hardware TPM Module Support



TPM Support

Hardware TPM (Trusted Platform Module) module is designed to provide hardware-based, security-related functions.

You can store your sensitive data & passwords by encryption keys for advanced security.

```
operation == "MIRROR_X":  
mirror_mod.use_x = True  
mirror_mod.use_y = False  
mirror_mod.use_z = False  
operation == "MIRROR_Y":  
mirror_mod.use_x = False  
mirror_mod.use_y = True  
mirror_mod.use_z = False  
operation == "MIRROR_Z":  
mirror_mod.use_x = False  
mirror_mod.use_y = False  
mirror_mod.use_z = True  
  
selection  
ob.set  
lar_ob.  
context  
("Se  
int("pic  
OPERATOR CLASS  
  
types.Operator):  
on X mirror to the selected  
object.mirror_mirror_x"  
mirror X"
```

Kensington Lock with Padlock Combo Design

Protect the unit with a physical Kensington Lock with Padlock Combo Design.

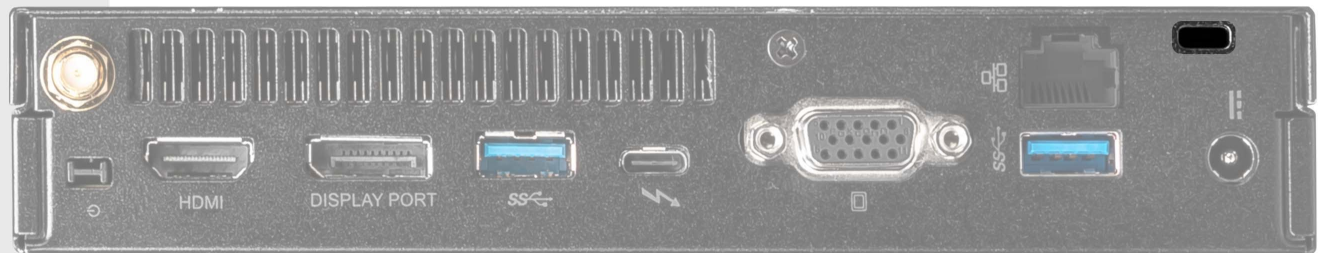
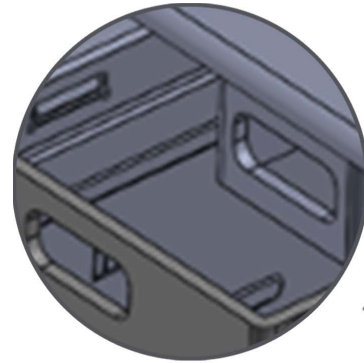

VESA Mountable with External Power Switch Design



The VESA Mountable design allows you to hook up PRO DP10 anywhere you like, improving its flexibility and letting users have good space management at home or office.

The external power switch brings the most convenient way to turn it on.

Easy To Maintenance Design

Users can easily upgrade two M.2 SSD, one 2.5" HDD/SSD, and two SO-DIMMs by disassembling the side covers.

Make PRO DP10 an even more flexible desktop and reduce the time wasted on upgrading.

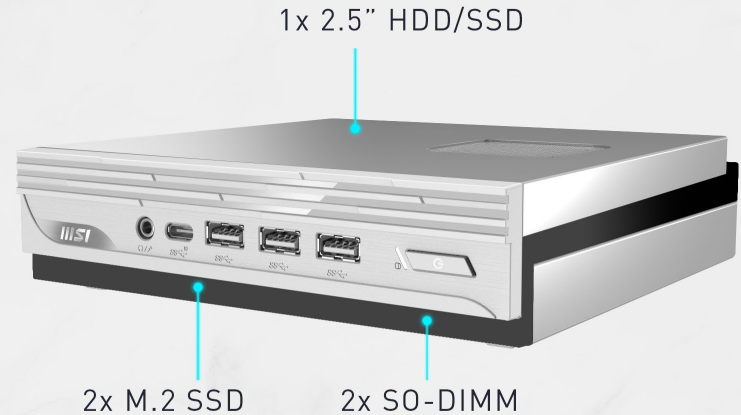

Switchable VGA to COM Port Design

A Switchable VGA to COM port (optional by request) will let you fully connect to your POS devices such as barcode scanners, receipt printers and many more.

The COM ports can also communicate with the programmable logic controllers (PLCs) or with other modules such as operator/HMI, motor controllers, a robot or vision system in the intelligent factory.

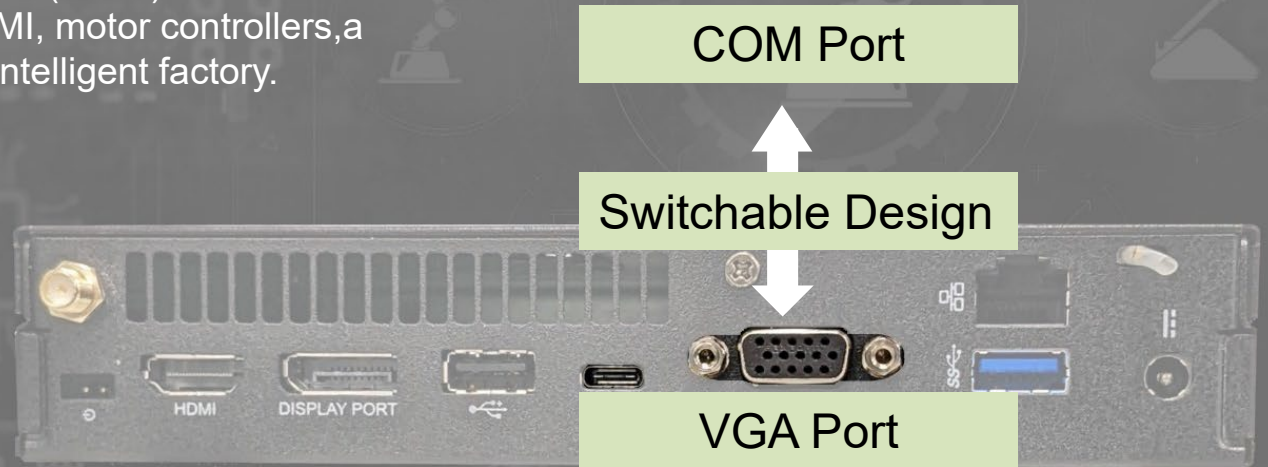

I/O Ports Review



Front

1. 3x USB 3.2 Gen 1 Type A
2. 1x USB 3.2 Gen 2 Type C
3. 1x Mic-in/Headphone-out combo

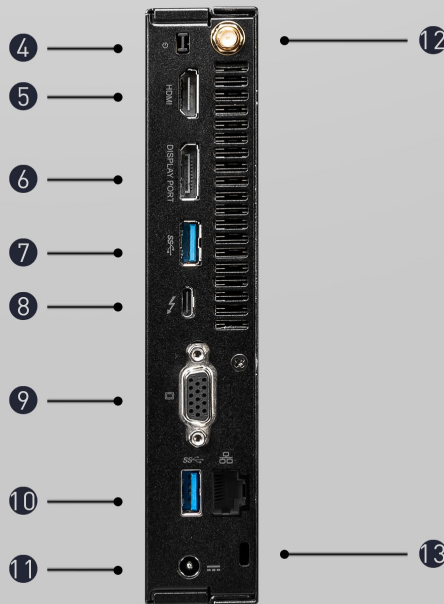
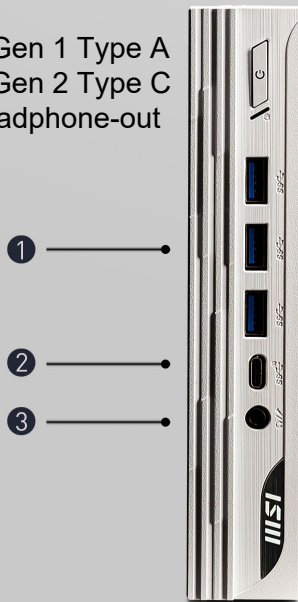

Rear:

4. 1x Extended Power Switch
5. 1x HDMI out (2.0b)
6. 1x DisplayPort (1.4)
7. 1x USB 3.2 Gen 1 Type A
8. 1x Thunderbolt 4
9. 1x D-Sub (VGA)
10. 1x USB 3.2 Gen 1 Type A,
1x RJ45 LAN (2.5G)
11. 1x DC Jack
12. 1x Wi-Fi Antenna
13. 1x Kensington Lock

Secure Design



TPM 2.0



Kensington & Padlock
Combo Design

Compact yet Powerful



13th Gen CPU



Thunderbolt 4



1.1 Liter



Compact Size

High-Speed



Wi-Fi 6E Support



2.5G LAN



Exclusive Software



MSI Cloud Center



MSI Center

Convenient Design



VESA Mountable



Sound Tune



PRO DP10 Series

Business & Productivity Desktop PC

User Friendly



External
Power Switch



Easy to Upgrade

Multi-tasking



4-Display Support



Various I/O

PRO DP10 13M - Specification

msi

Operating System	Windows 11 Home and Windows 11 Pro supported
CPU	Intel® Core™ i7-1360P Intel® Core™ i5-1340P Intel® Core™ i3-1315U
Chipset	Intel® SoC
Storage	2x M.2 SSD (PCIe), 1x 2.5" HDD / SSD
System Memory	2x DDR4 3200MHz SO-DIMMs, up to 64GB
Graphics	Intel® UHD Graphics or Intel® Iris® Xe Graphics (i5 above)
Sound	Realtek® ALC256
I/O (Front)	1x USB 3.2 Gen 2 Type C, 3x USB 3.2 Gen 1 Type A, 1x Mic-in/Headphone-out combo
I/O (Rear)	1x Thunderbolt 4, 2x USB 3.2 Gen 1 Type A, 1x RJ45, 1x HDMI out (2.0b), 1x DisplayPort (1.4), 1x D-Sub (VGA) (Switchable to COM port for option), 1x Wi-Fi Antenna
TPM	dTPM 2.0 module support
Wireless LAN	Intel® Wi-Fi 6E AX211 / Intel® Wi-Fi AC3168 (either one)
Bluetooth	5.3 (AX211) / 4.2 (AC3168)
LAN	2.5G LAN (Realtek® RTL8125BG-CG)
AC Adapter / PSU	120W Adapter
Cooling System	Fan Cooler
Volume	1.1 Liter/ 2.32pt
Dimension (WxDxH)	178.82 x 34.48 x 179mm (7.04 x 1.36 x 7.05 inch)
Weight (N.W./ G.W.)	1.1 kg (2.43 lbs) / 2.1 kg (4.63lbs)
VESA Mount	Support 75 x 75 mm
Accessory	1x External power switch (optional) 1x Wi-Fi Antenna 1x SATA Cable (if the model is with SSD only)



Product comparison – Ultrasmall DT



	MSI DP10 Series 	Dell OptiPlex 5000 Micro 	HP Elite Mini 600 G9 	Lenovo ThinkCentre M90q Tiny Gen 3 
CPU	13gen Intel CPU	12gen Intel CPU	12gen Intel CPU	12gen Intel CPU
LAN	1x 2.5GbE	1x 1GbE	1x 1GbE	1x 1GbE
Display output	4 (HDMI, DP, TBT, VGA)	Up to 3 (2x DP, 1x optional)	Up to 4 (2x DP, HDMI, 1x optional)	Up to 4 (DP, HDMI, 2x optional)
USB Type-C feature	Front: data Rear: TBT4	Front: data	Front: data Rear: data+DP	Front: data
Security	Kensington lock w/ Padlock combo design	Chassis intrusion, Padlock, Kensington lock	Chassis intrusion, Padlock, Kensington lock	Chassis intrusion, Padlock, Kensington lock

Successful & Stylish B2B projects

Over the past years, MSI has successfully supported Countless of commercial projects, including government tenders, restaurant & hotel facilitation, shopping mall navigation projects, school & university developments and professional office projects.

Find more details about many of these projects on:

<https://www.msi.com/pro-projects/global>

