

Quick Installation Guide

Range Extender

* Images are for demonstration only.

1. Power On

Plug the extender into a power outlet next to your router. Wait until its Signal LED turns solid red or blinking orange.

Note: For safety, only plug the extender in the direction as shown below.

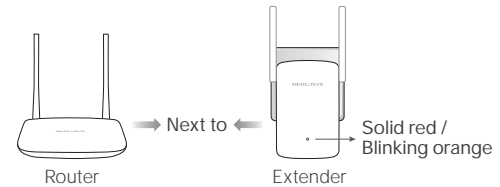

2. Set Up

Method 1: Via the MERCUSYS App

1. Scan the QR code to download the MERCUSYS app from the Apple App Store or Google Play.

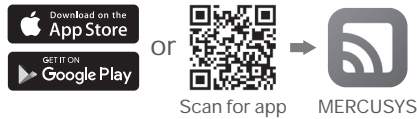

2. Launch the app and log in with your MERCUSYS ID.

Note: If you don't have an account, create one first.

3. Follow app instructions to set up the extender.

Method 2: Via a Web Browser

1. Connect your wireless device to the extender (MERCUSYS_RE_XXXX).

Note: The default SSID (network name) is printed on the product label at the back of the extender.

2. Launch a web browser and visit <http://mwlogin.net>. Create a password to log in.

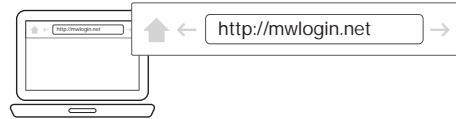

3. Follow web instructions to complete the setup.

Method 3: Via the WPS Button

1. Press the WPS button on your router.
2. Within 2 minutes, press the WPS or RESET/WPS button on the extender for 1 second.

The Signal LED should change from blinking to solid green or orange, indicating a successful connection to your router.

Note: If the LED does not turn solid green or orange, try again or use another method.

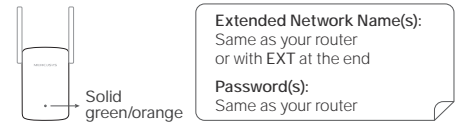

3. Relocate

1. Plug in the extender about halfway between your router and the Wi-Fi dead zone. The location you choose must be within the range of your router.
2. Wait for about 2 minutes until the Signal LED turns solid green. If it doesn't, relocate the extender closer to the router to achieve better signal quality.

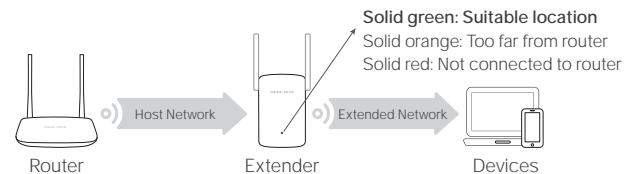

😊 Enjoy!

Connect your device to the extender using the extended network name(s). The extender shares the same Wi-Fi password(s) as your router.

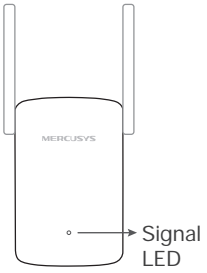

LED Explanation

LED	Status	Indication (For Range Extender Mode)
	Off	Power is off.
	Blinking Green	The extender is starting, or connecting to the main network.
	Blinking Orange*	The extender is ready for setup.
	Solid Red	The extender is not connected to the main network.
	Solid Green	The extender is connected to the main network and works well.
	Solid Orange	The extender is connected to the main network, but is too far away from the router.

*Earlier models do not have this LED status. The LED shows solid red instead.

Access Point Mode (if supported)

If your extender has an Ethernet port, you can also set up it as an access point to transform your existing wired network to a wireless one.

For detailed instructions, please visit <http://www.mercusys.com> and go to your extender's support page to get its User Guide.

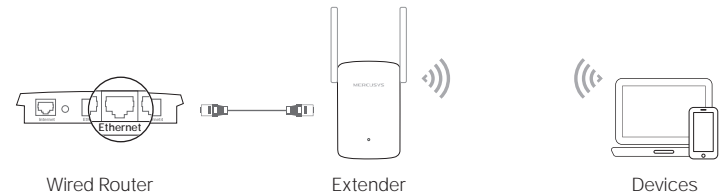

FAQ (Frequently Asked Questions)

Q1. How do I reset the extender?

- With the extender powered on, press and hold the Reset or RESET/WPS button until the Signal LED turns off, then release the button. The extender will reboot and reset to factory settings.

Q2. What should I do if I cannot access the extender's web management page?

- Make sure your wireless device is connected to the extended network using the extended SSID.
- Verify that <http://mwlogin.net> is correctly entered in the web browser.
- If you are using a computer, make sure it is set to obtain an IP address automatically. Unplug the Ethernet cable if any.
- Use another web browser and try again.
- Refer to Q1 to reset the extender and try again.

Q3. What should I do if I forgot my login password of the web management page?

- Refer to Q1 to reset the extender to its factory default settings, then create a password to log in.

Q4. What should I do if the Signal LED doesn't turn solid green or orange after completing setup via a web browser?

- You may have entered incorrect Wi-Fi password(s) for your router during the setup. Check the password(s) and try again.
- Make sure the extender is close to your router, preferably within 16 feet, and away from large electrical appliances.
- If you have enabled wireless MAC filtering, wireless access control, or access control list (ACL) on your router, disable them first, then follow any

method on the front page to complete the configuration.

- Try setting up via the WPS button.
- Reset the extender and go through the setup again.

If you are still having problems, contact our technical support.

 For technical support, user manuals and more information, please visit <http://www.mercusys.com/support>.

Safety Information



- Keep the device away from water, fire, humidity or hot environments.
- Do not attempt to disassemble, repair, or modify the device. If you need service, please contact us.
- Do not use the device where wireless devices are not allowed.
- The socket-outlet shall be installed near the equipment and shall be easily accessible.
- For passthrough devices, plug the power strips into the integrated electrical sockets of the devices, but devices of the same or another type not be stacked in normal use. Do not plug in a row. 

Please read and follow the above safety information when operating the device. We cannot guarantee that no accidents or damage will occur due to improper use of the device. Please use this product with care and operate at your own risk.

MERCUSYS hereby declares that the device is in compliance with the essential requirements and other relevant provisions of directives 2014/53/EU, 2009/125/EC, 2011/65/EU and (EU)2015/863.

The original EU Declaration of Conformity may be found at <https://www.mercusys.com/en/ce>.

MERCUSYS hereby declares that the device is in compliance with the essential requirements and other relevant provisions of the Radio Equipment Regulations 2017.

The original UK Declaration of Conformity may be found at <https://www.mercusys.com/support/ukca/>