

VERIFICATION OF COMPLIANCE

- **Equipment** : USB-C® Dual HDMI™ Mini Dock
Model No. : JCD381
Applicant : KaiJet Technology International Corporation
8F., No.109, Zhongcheng Rd., Tucheng Dist.,
New Taipei City 236, Taiwan, R.O.C.

**I HEREBY****DECLARE THAT :**

The equipment is in accordance with the procedures are given in **ANSI C63.4-2014** and the energy emitted by this equipment was **Passed by CISPR PUB. 22, FCC Part 15 Subpart B**. Radiated and conducted emissions are compliance in **Class B** limits. The test was carried out on **Jan. 06, 2022** at **SPORTON INTERNATIONAL INC. Hsinhua Laboratory**.

William Li



EMI TEST REPORT

Filing Type : Supplier's Declaration Of Conformity
Equipment : USB-C® Dual HDMI™ Mini Dock
Brand Name : j5create
Model Name : JCD381
Applicant : KaiJet Technology International Corporation
8F., No.109, Zhongcheng Rd., Tucheng Dist.,
New Taipei City 236, Taiwan, R.O.C.
Manufacturer : Magic Control Technology Corporation
10F., No.123, Zhongcheng Rd., Tucheng Dist.,
New Taipei City 236, Taiwan R.O.C.
Standard : 47 CFR FCC Rules and Regulations Part 15
Subpart B, Class B Digital Device

The product was received on Dec. 20, 2021, and testing was started from Dec. 22, 2021 and completed on Jan. 06, 2022. We, SPORTON INTERNATIONAL INC. Hsinhua Laboratory, would like to declare that the tested sample has been evaluated in accordance with the procedures given in ANSI C63.4-2014 and shown compliance with the applicable technical standards.

The test results in this report apply exclusively to the tested model / sample. Without written approval of SPORTON INTERNATIONAL INC. Hsinhua Laboratory, the test report shall not be reproduced except in full.

Approved by: William Li

SDoC by:

SPORTON INTERNATIONAL INC. Hsinhua Laboratory
No.52, Huaya 1st Rd., Guishan Dist., Taoyuan City 333411, Taiwan (R.O.C.)



Table of Contents

History of this test report.....3

Summary of Test Result.....4

1. General Description of Equipment under Test.....5

 1.1. Basic Description of Equipment under Test 5

 1.2. Feature of Equipment under Test..... 5

 1.3. Configuration Test Mode of the EUT 5

 1.4. Modification of EUT..... 5

2. Test Configuration of Equipment under Test6

 2.1. Details of EUT Test Modes..... 6

 2.2. Description of Test System..... 7

 2.3. Connection Diagram of Test System 8

 2.4. Details of EUT Test Setup 10

3. General Information of Test.....11

 3.1. Test Facilities 11

 3.2. Test Standards..... 11

 3.3. Test Voltage/Frequencies 11

 3.4. Test Distance and Frequency Range Investigated 11

 3.5. Operating Condition 11

 3.6. Labelling requirements 12

 3.7. User Information..... 12

4. Conducted Emissions Measurement13

 4.1. Limit 13

 4.2. Test Procedures..... 14

 4.3. Measurement Results Calculation 14

 4.4. Typical Test Setup Layout 15

 4.5. Test Result..... 17

5. Radiated Emissions Measurement19

 5.1. Radiated Emission below 1GHz 19

 5.2. Radiated Emission above 1GHz..... 26

6. Uncertainty of Test Site31

 6.1. Measurement Uncertainty 31

7. List of Measuring Equipment Used32

Appendix A. Test Photos

Photographs of EUT v01



Summary of Test Result

Report Clause	Ref Std. Clause	Test Items	Result (PASS/FAIL)	Remark
4	15.107	Conducted Emissions of Powerline	PASS	Under limit 17.24 dB at 0.16 MHz
5.1	15.109	Radiated Emissions below 1GHz	PASS	Under limit 3.36 dB at 122.56 MHz
5.2	15.109	Radiated Emissions above 1GHz	PASS	Under limit 5.31 dB at 1.565 GHz

Note 1: From Sporton Project No.: FD7O1226-05

Declaration of Conformity:

1. The Radiated Emission and Conducted Transient Disturbances test result (Pass/Fail) which exclude measurement uncertainty. Note that measurement values may risk exceeding the limit of regulation standard. If measurement uncertainty is included in test results.
2. The Radiated Emission and Conducted Transient Disturbances measurement uncertainty please refer to report chapter 6.1 "Measurement Uncertainty".

Comments and explanations:

None

Reviewed by: Mark Ma

Report Producer: Ann Hou



1. General Description of Equipment under Test

1.1. Basic Description of Equipment under Test

Equipment : USB-C® Dual HDMI™ Mini Dock
Model No. : JCD381
Power Supply Type : From Power Adapter
AC Power Cord : Wall-Mount, 2 pin
DC Power Cable : D-Shielded, 2 m
The maximum operating frequency : 500 MHz

1.2. Feature of Equipment under Test

For a more detailed features description, please refer to the manufacturer's specifications or the User's Manual.

1.3. Configuration Test Mode of the EUT

	SKU 1	SKU 2	SKU 3	SKU 4
EUT Cover	Black	Black	Silver	Silver
EUT Cable	30CM	30CM	20CM	20CM
RJ45 connector	Main Source	2 nd Source	Main Source	2 nd Source

1.4. Modification of EUT

No modifications to the EUT were made.



2. Test Configuration of Equipment under Test

2.1. Details of EUT Test Modes

Model No.: JCD381 was selected as the main test model and its data was recorded in this report. The equipment under test was performed the following test modes:

Test Items	Description of test modes
Conducted Emission	Mode 1. SKU 1 HDMI 1: 3840*2160 30Hz+HDMI 2: 2048*1152 60Hz, USB R/W,LAN 1Gbps Mode 2. SKU 2 HDMI 1: 3840*2160 30Hz+HDMI 2: 2048*1152 60Hz, USB R/W,LAN 1Gbps Mode 3. SKU 3 HDMI 1: 3840*2160 30Hz+HDMI 2: 2048*1152 60Hz, USB R/W,LAN 1Gbps Mode 4. SKU 4 HDMI 1: 3840*2160 30Hz+HDMI 2: 2048*1152 60Hz, USB R/W,LAN 1Gbps Mode 5. SKU 1 HDMI 1: 2048*1152 30Hz+HDMI 2: 2048*1152 60Hz, USB R/W,LAN 1Gbps Mode 6. SKU 1 HDMI 1: 1920*1080 60Hz+HDMI 2: 1920*1080 60Hz, USB R/W,LAN 1Gbps Mode 7. SKU 1 HDMI 1: 800*600 60Hz+HDMI 2: 800*600 60Hz, USB R/W,LAN 1Gbps cause "mode 1" generated the worst test result; it was reported as final data.
Radiated Emissions <below 1GHz>	Mode 1. SKU 1 HDMI 1: 3840*2160 30Hz+HDMI 2: 2048*1152 60Hz, USB R/W,LAN 1Gbps Mode 2. SKU 2 HDMI 1: 3840*2160 30Hz+HDMI 2: 2048*1152 60Hz, USB R/W,LAN 1Gbps Mode 3. SKU 3 HDMI 1: 3840*2160 30Hz+HDMI 2: 2048*1152 60Hz, USB R/W,LAN 1Gbps Mode 4. SKU 4 HDMI 1: 3840*2160 30Hz+HDMI 2: 2048*1152 60Hz, USB R/W,LAN 1Gbps Mode 5. SKU 1 HDMI 1: 2048*1152 30Hz+HDMI 2: 2048*1152 60Hz, USB R/W,LAN 1Gbps Mode 6. SKU 1 HDMI 1: 1920*1080 60Hz+HDMI 2: 1920*1080 60Hz, USB R/W,LAN 1Gbps Mode 7. SKU 1 HDMI 1: 800*600 60Hz+HDMI 2: 800*600 60Hz, USB R/W,LAN 1Gbps cause "mode 1" generated the worst test result; it was reported as final data.
Radiated Emissions <above 1GHz>	Mode 1. SKU 1 HDMI 1: 3840*2160 30Hz+HDMI 2: 2048*1152 60Hz, USB R/W,LAN 1Gbps Mode 2. SKU 2 HDMI 1: 3840*2160 30Hz+HDMI 2: 2048*1152 60Hz, USB R/W,LAN 1Gbps Mode 3. SKU 3 HDMI 1: 3840*2160 30Hz+HDMI 2: 2048*1152 60Hz, USB R/W,LAN 1Gbps Mode 4. SKU 4 HDMI 1: 3840*2160 30Hz+HDMI 2: 2048*1152 60Hz, USB R/W,LAN 1Gbps Mode 5. SKU 1 HDMI 1: 2048*1152 30Hz+HDMI 2: 2048*1152 60Hz, USB R/W,LAN 1Gbps Mode 6. SKU 1 HDMI 1: 1920*1080 60Hz+HDMI 2: 1920*1080 60Hz, USB R/W,LAN 1Gbps Mode 7. SKU 1 HDMI 1: 800*600 60Hz+HDMI 2: 800*600 60Hz, USB R/W,LAN 1Gbps cause "mode 1" generated the worst test result; it was reported as final data.



2.2. Description of Test System

Conducted emission and radiated emission below 1GHz

No.	Peripheral	Manufacturer	Model Number	FCC ID	Remarks
For Local					
A	Laptop	Lenovo	TP00088C	DoC	-
B	Adapter	Apple	A1719	DoC	-
C	USB Hub	j5create	JUH340	DoC	-
D	Printer	Fuji Xerox	Phaser 3121	DoC	-
E	Mouse	ASUS	MOBTUO	DoC	-
F	Portable External HDD	PQI	H566	DoC	-
G	LCD Monitor	ASUS	PB27U	DoC	-
H	LCD Monitor	acer	B273HU	DoC	-
I	Portable SSD*2	Transcend	TS240GESD240C	DoC	-
For Remote					
Z1	Laptop	DELL	Latitude E5520	DoC	-

Radiated emission above 1GHz

No.	Peripheral	Manufacturer	Model Number	FCC ID	Remarks
For Local					
A	Laptop	Lenovo	TP00088C	DoC	-
B	Adapter	Apple	A1719	DoC	-
C	USB Hub	j5create	JCH377	DoC	-
D	Printer	EPSON	C61	N/A	-
E	Mouse	Microsoft	1113	DoC	-
F	Portable External HDD	PQI	H566	DoC	-
G	LCD Monitor	Benq	EL2870-B	N/A	-
H	LCD Monitor	acer	B273HU	DoC	-
I	Portable SSD*2	Transcend	TS240GESD240C	DoC	-
For Remote					
Z1	Laptop	DELL	Latitude E5520	DoC	-

2.3. Connection Diagram of Test System

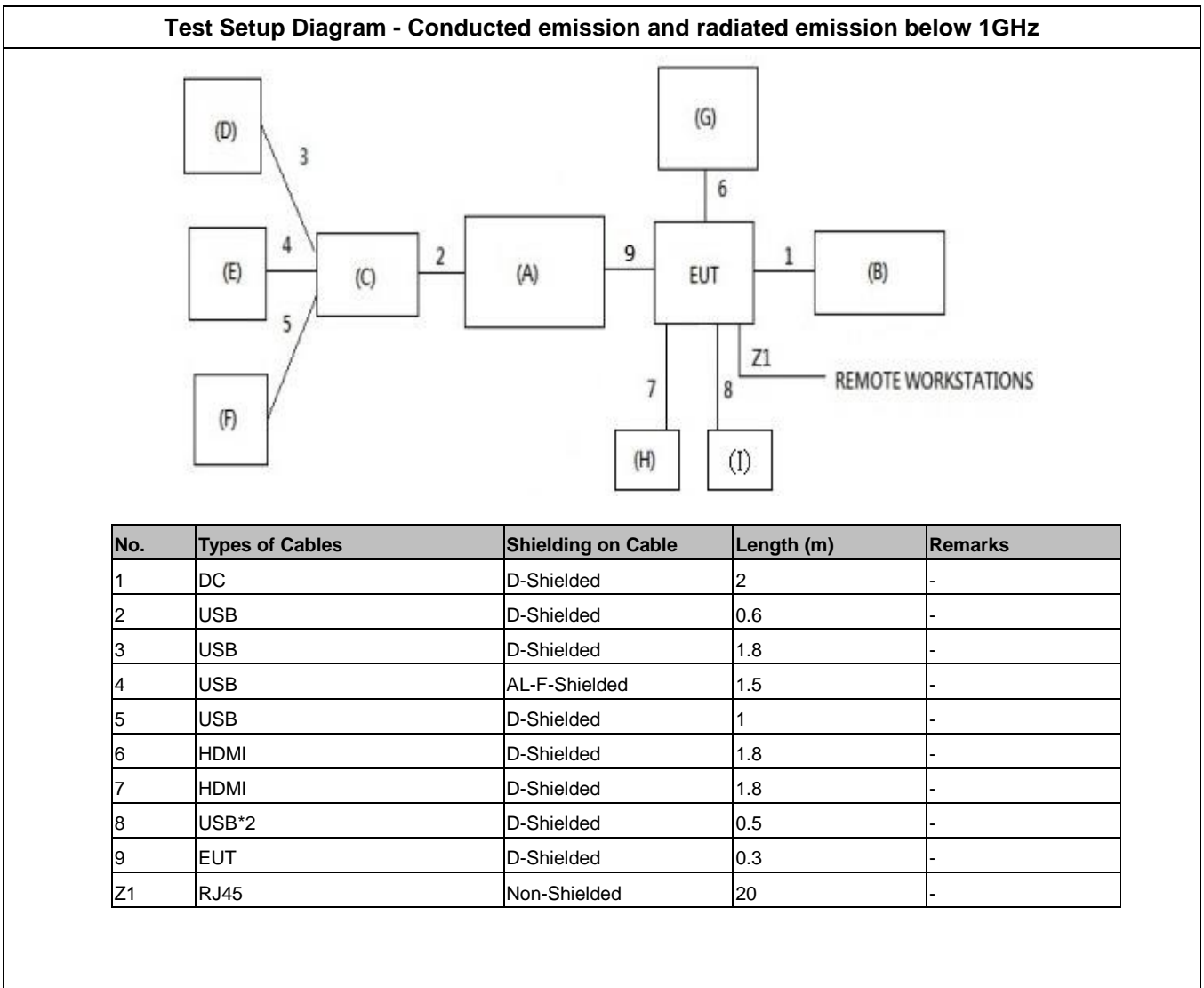

Test Setup Diagram - Radiated emission above 1GHz

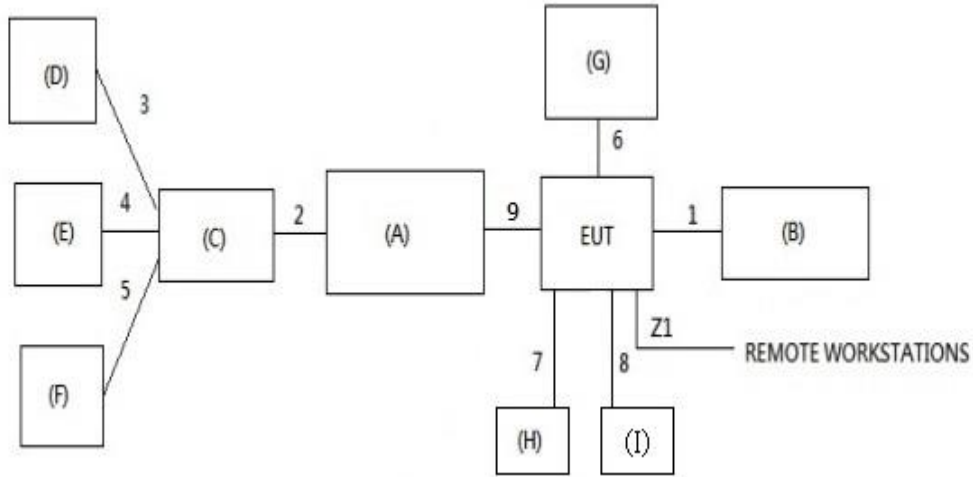

No.	Types of Cables	Shielding on Cable	Length (m)	Remarks
1	DC	D-Shielded	2	-
2	USB	D-Shielded	0.4	-
3	USB	D-Shielded	1.8	-
4	USB	AL-F-Shielded	1.8	-
5	USB	D-Shielded	1	-
6	HDMI	D-Shielded	1.8	-
7	HDMI	D-Shielded	1.8	-
8	USB*2	D-Shielded	0.5	-
9	EUT	D-Shielded	0.3	-
Z1	RJ45	Non-Shielded	10	-



2.4. Details of EUT Test Setup

An executive program, "BurnInTest" under WIN 10(local) and WIN 7(remote) was used as the test software. The program was executed as follows:

- The Laptop executed "BurnInTest" to keep displaying the "H" pattern on the screen via EUT.
- The Laptop executed "BurnInTest" to access data in SSD by EUT.
- The Laptop executed "BurnInTest" to access data by HDD.
- The Laptop executed "Word" to keep the printer printing.
- The Laptop executed "Media player" to play audio by speaker of monitor via EUT.
- The Laptop executed "ping" to observe the link to the EUT.



3. General Information of Test

3.1. Test Facilities

Test Lab : Sporton International Inc. Hsinhua Laboratory						
<input checked="" type="checkbox"/>	Hsinhua (TAF: 3785)	ADD : No.52, Huaya 1st Rd., Guishan Dist., Taoyuan City 333411, Taiwan (R.O.C.)				
		TEL : 886-3-327-3456	FAX : 886-3-327-0973			
		FCC Designation Number: TW1129				
<input checked="" type="checkbox"/>		ADD : No.3, Ln. 238, Kangle St., Neihu Dist., Taipei City 114040, Taiwan (R.O.C.)				
		TEL : 886-2-2631-5551	FAX : 886-2-2631-9740			
		FCC Designation Number: TW1133				
Test Items	Test Site No.	Test Engineer	Test Environment		Test Date	Remark
			temp °C	humidity %		
Powerline Conducted Emissions	CO01-NH	Willy	23.1~23.2	72~73	23/Dec/2021	-
Radiated Emissions (below 1GHz)	OS03-NH	Louis	21.6~21.7	58.7~58.8	23/Dec/2021	-
Radiated Emissions (above 1GHz)	03CH04-HY	Yen-Liang	21.5~22.5	56~57	06/Jan/2022	-

3.2. Test Standards

Test items	Test Standards and Test Procedures
Radiated and Conducted Emissions	ANSI C63.4:2014 with FCC Method 47 CFR Part 15, Subpart B, Class B Digital Device, CISPR PUB. 22

3.3. Test Voltage/Frequencies

Power Supply Type	Voltage/Frequencies
Power Adapter	120V / 60Hz

3.4. Test Distance and Frequency Range Investigated

Test Items	Frequency Range	Remark
Powerline Conducted Emissions	150 kHz to 30 MHz	-
Radiated Emissions (below 1GHz)	30 MHz to 1,000 MHz	Measurement distance is 10 m.
	1,000 MHz to 18,000 MHz	Measurement distance is 3 m.
Radiated Emissions (above 1GHz)	Above 18,000 MHz	Measurement distance is 1 m.

3.5. Operating Condition

- Full system.



3.6. Labelling requirements

The devices shall bear the following statement in a conspicuous location on the device:

This device complies with part 15 of the FCC Rules. Operation is subject to the following two conditions: (1) This device may not cause harmful interference, and (2) this device must accept any interference received, including interference that may cause undesired operation.

3.7. User Information

The users manual or instruction manual for an intentional or unintentional radiator shall caution the user that changes or modifications not expressly approved by the party responsible for compliance could void the user's authority to operate the equipment.

For a Class B digital device or peripheral, the instructions furnished the user shall include the following or similar statement, placed in a prominent location in the text of the manual:

This equipment has been tested and found to comply with the limits for a Class B digital device, pursuant to part 15 of the FCC Rules. These limits are designed to provide reasonable protection against harmful interference in a residential installation.

This equipment generates, uses and can radiate radio frequency energy and, if not installed and used in accordance with the instructions, may cause harmful interference to radio communications. However, there is no guarantee that interference will not occur in a particular installation.

If this equipment does cause harmful interference to radio or television reception, which can be determined by turning the equipment off and on, the user is encouraged to try to correct the interference by one or more of the following measures:

- Reorient or relocate the receiving antenna.
- Increase the separation between the equipment and receiver.
- Connect the equipment into an outlet on a circuit different from that to which the receiver is connected.
- Consult the dealer or an experienced radio/TV technician for help.

For a Class A digital device or peripheral, the instructions furnished the user shall include the following or similar statement, placed in a prominent location in the text of the manual:

This equipment has been tested and found to comply with the limits for a Class A digital device, pursuant to part 15 of the FCC Rules. These limits are designed to provide reasonable protection against harmful interference when the equipment is operated in a commercial environment. This equipment generates, uses, and can radiate radio frequency energy and, if not installed and used in accordance with the instruction manual, may cause harmful interference to radio communications. Operation of this equipment in a residential area is likely to cause harmful interference in which case the user will be required to correct the interference at his own expense.



4. Conducted Emissions Measurement

Conducted Emissions were measured according to the methods defined in ANSI C63.4-2014 Section 7.
The EUT is which satisfies the Class B disturbance limits.

4.1. Limit

Limits for conducted disturbance at the mains ports of class A			
Frequency range MHz	Coupling device	Detector type / bandwidth	Class A limits dB(μV)
0,15 – 0,5	AMN	Quasi-peak / 9 kHz	79
0,50 – 30			73
0,15 – 0,5	AMN	Average / 9 kHz	66
0,50 – 30			60
Note 1: The lower limit shall apply at the transition frequency.			
Limits for conducted disturbance at the mains ports of class B			
Frequency range MHz	Coupling device	Detector type / bandwidth	Class B limits dB(μV)
0,15 – 0,5	AMN	Quasi-peak / 9 kHz	66 - 56
0,5 – 5			56
5 – 30			60
0,15 – 0,5	AMN	Average / 9 kHz	56 - 46
0,5 – 5			46
5 – 30			50
Note 1: The lower limit shall apply at the transition frequencies.			
Note 2: The limit decreases linearly with the logarithm of the frequency in the range 0.15 MHz to 0.50 MHz.			



4.2. Test Procedures

Tabletop equipment:

- a). The EUT was warmed up for 15 minutes before testing started.
- b). The EUT was placed on a desk 0.8 meter height from the metal ground plane and 0.4 meter from the conducting wall of the shielding room and it was kept at least 0.8 meter from any other grounded conducting surface.
- c). Connect EUT to the power mains through a line impedance stabilization network (LISN).
- d). All the support units are connect to the other LISN.
- e). The LISN provides 50 ohm, coupling impedance for the measuring instrument.
- f). The FCC states that a 50 ohm, 50 microhenry LISN should be used.
- g). Both sides of AC line were checked for maximum conducted interference.
- h). The frequency range from 150 kHz to 30 MHz was searched.
- i). Set the test-receiver system to Peak Detect Function and Specified Bandwidth with Maximum Hold Mode.
- j). All emissions not reported here are more than 10 dB below the prescribed limit.

Floor-standing equipment:

- a). The EUT was warmed up for 15 minutes before testing started.
- b). The EUT was placed on the horizontal ground reference plane, 12mm above ground.
- c). Connect EUT to the power mains through a line impedance stabilization network (LISN).
- d). All the support units are connect to the other LISN.
- e). The LISN provides 50 ohm, coupling impedance for the measuring instrument.
- f). The CISPR states that a 50 ohm, 50 microhenry LISN should be used.
- g). Both sides of AC line were checked for maximum conducted interference.
- h). The frequency range from 150 kHz to 30 MHz was searched.
- i). Set the test-receiver system to Peak Detect Function and Specified Bandwidth with Maximum Hold Mode.
- j). All emissions not reported here are more than 10 dB below the prescribed limit.

4.3. Measurement Results Calculation

The measured Level is calculated using:

$$\text{Corrected Reading (dB}\mu\text{V)} = \text{LISN Factor} + \text{Cable Loss} + \text{Read Level}$$

For example at 0.3 MHz if the LISN Factor is 10.48 dB, the cable loss is 0.10 dB, the measured voltage is 36.39 dB μ V, the signal strength would be calculated:

$$\text{Corrected Reading (dB}\mu\text{V)} = 10.48 \text{ dB} + 0.10 \text{ dB} + 36.39 \text{ dB}\mu\text{V} = 46.97 \text{ dB}\mu\text{V}$$

4.4. Typical Test Setup Layout

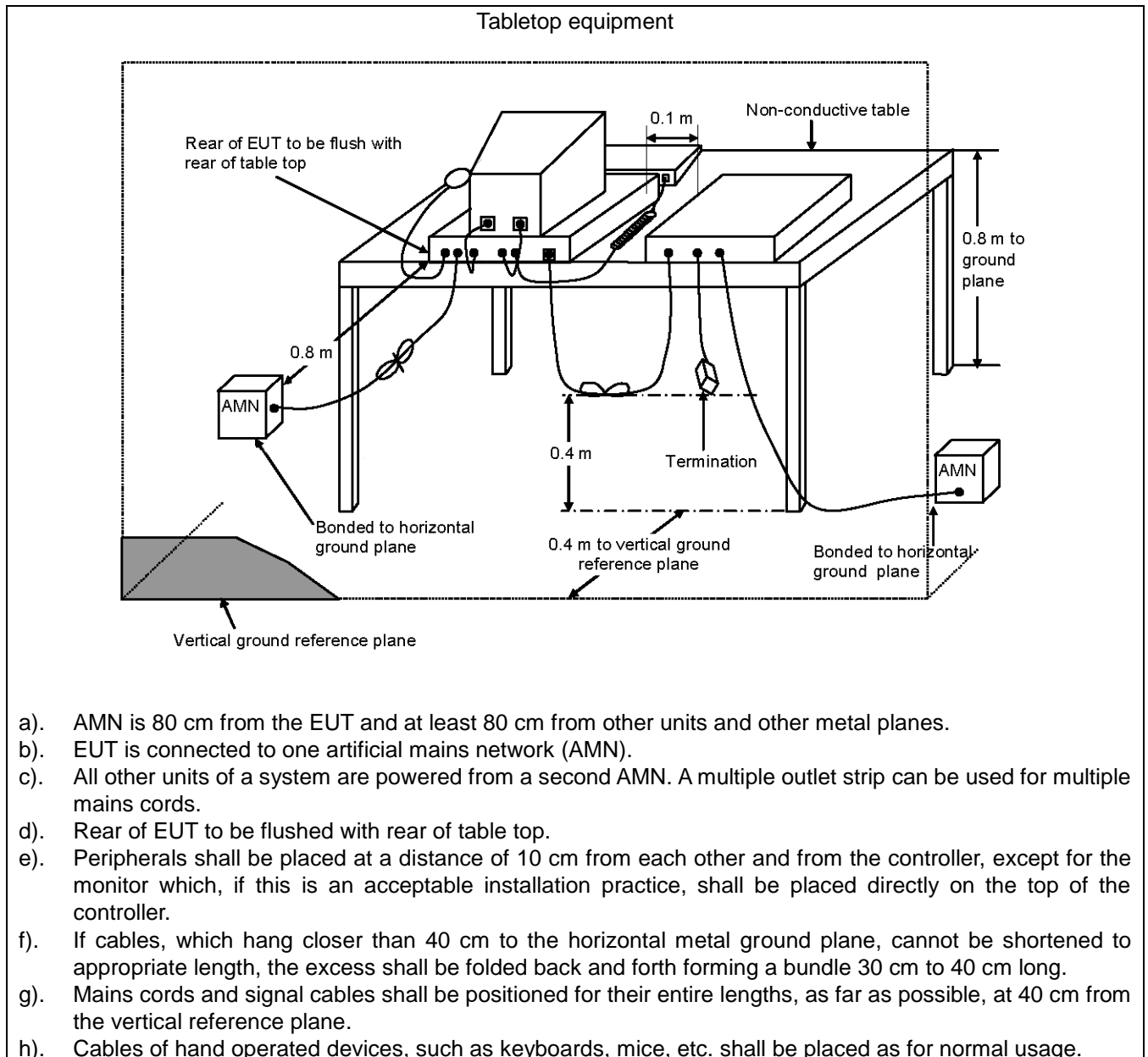

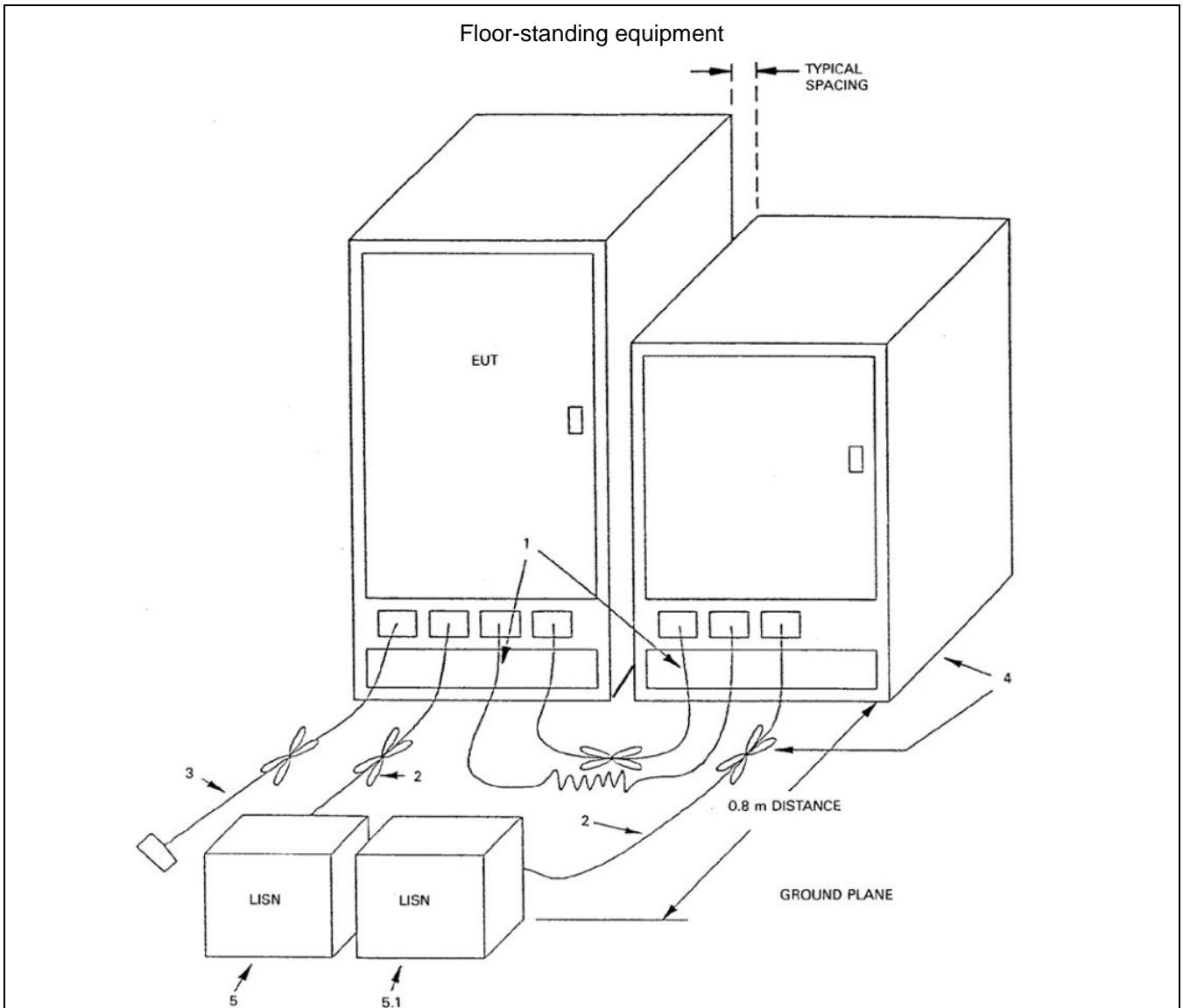

- a). Excess I/O cables shall be bundled in the center. If bundling is not possible, the cables shall be arranged in a serpentine fashion. Bundling shall not exceed 40 cm in length.
- b). Excess power cords shall be bundled in the center or shortened to appropriate length.
- c). I/O cables that are not connected to a peripheral shall be bundled in the center. The end of the cable may be terminated, if required, using the correct terminating impedance. If bundling is not possible, the cable shall be arranged in a serpentine fashion.
- d). EUT and all cables shall be insulated, if required, from the ground plane by up to 12 mm of insulating material.
- e). EUT connected to one LISN. LISN can be placed on top of, or immediately beneath, the ground plane.
 - 5.1 All other equipment powered from a second LISN or additional LISN(s).
 - 5.2 A multiple outlet strip can be used for multiple power cords of non-EUT equipment.



4.5. Test Result

Test Mode	Mode 1		
Test Frequency	0.15 MHz ~ 30 MHz	Test Voltage	AC 120V / 60Hz
<p>■ The test was passed at the minimum margin that marked by the frame in the following data</p>			

Line

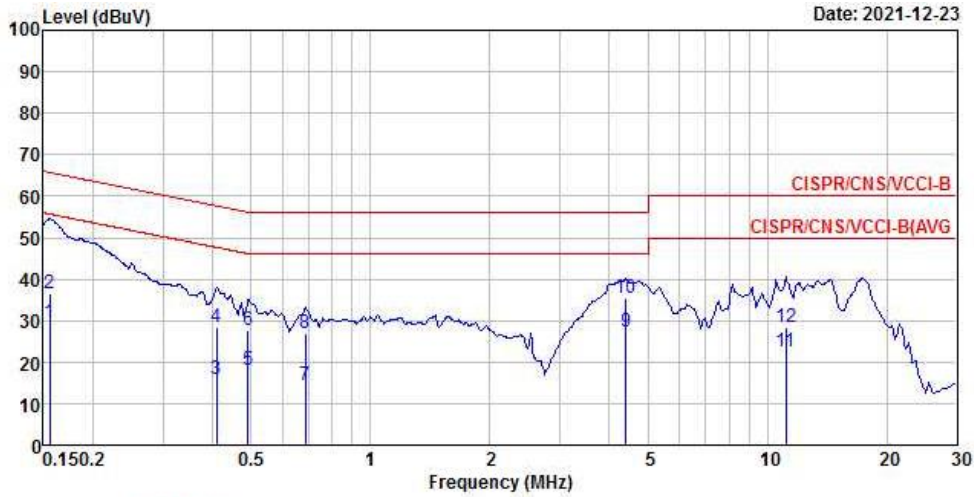

	Freq	Level	Over Limit	Limit Line	Read Level	LISN Factor	Cable Loss	Remark
	MHz	dBuV	dB	dBuV	dBuV	dB	dB	
1	0.16	29.64	-26.05	55.69	19.25	10.29	0.10	Average
2	0.16	36.51	-29.18	65.69	26.12	10.29	0.10	QP
3	0.41	15.73	-31.91	47.64	5.35	10.27	0.11	Average
4	0.41	28.48	-29.16	57.64	18.10	10.27	0.11	QP
5	0.49	18.04	-28.10	46.14	7.66	10.27	0.11	Average
6	0.49	27.74	-28.40	56.14	17.36	10.27	0.11	QP
7	0.69	14.33	-31.67	46.00	3.93	10.28	0.12	Average
8	0.69	26.97	-29.03	56.00	16.57	10.28	0.12	QP
9 @	4.41	27.25	-18.75	46.00	16.76	10.32	0.17	Average
10	4.41	35.55	-20.45	56.00	25.06	10.32	0.17	QP
11	11.15	22.39	-27.61	50.00	11.69	10.45	0.25	Average
12	11.15	28.48	-31.52	60.00	17.78	10.45	0.25	QP



Neutral

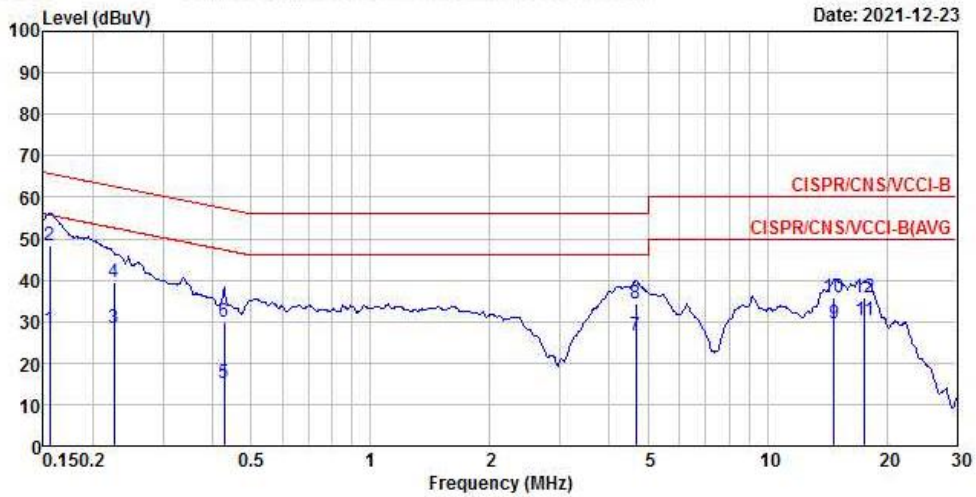

	Freq	Level	Over	Limit	Read	LISN	Cable	Remark
	MHz	dBuV	Limit	Line	Level	Factor	Loss	
			dB	dBuV	dBuV	dB	dB	
1	0.16	28.19	-27.50	55.69	17.79	10.30	0.10	Average
2 @	0.16	48.45	-17.24	65.69	38.05	10.30	0.10	QP
3	0.23	28.40	-24.21	52.61	18.01	10.29	0.10	Average
4	0.23	39.63	-22.98	62.61	29.24	10.29	0.10	QP
5	0.43	15.08	-32.21	47.29	4.69	10.28	0.11	Average
6	0.43	29.92	-27.37	57.29	19.53	10.28	0.11	QP
7	4.67	26.58	-19.42	46.00	16.05	10.36	0.17	Average
8	4.67	34.24	-21.76	56.00	23.71	10.36	0.17	QP
9	14.75	29.57	-20.43	50.00	18.67	10.58	0.32	Average
10	14.75	35.69	-24.31	60.00	24.79	10.58	0.32	QP
11	17.57	30.20	-19.80	50.00	19.23	10.64	0.33	Average
12	17.57	35.94	-24.06	60.00	24.97	10.64	0.33	QP



5. Radiated Emissions Measurement

Radiated Emissions were measured according to the methods defined in ANSI C63.4-2014 Section 8. The EUT is which satisfies the Class B disturbance limits.

5.1. Radiated Emission below 1GHz

5.1.1.Limit

radiated emissions at frequencies up to 1 GHz for Class A equipment			
Frequency range MHz	Measurement		Class A limits
	Distance (m)	Detector type / bandwidth	dB(μ V/m)
30 – 230	10	Quasi Peak / 120 kHz	40
230 – 1000			47
radiated emissions at frequencies up to 1 GHz for Class B equipment			
Frequency range MHz	Measurement		Class B limits
	Distance (m)	Detector type / bandwidth	dB(μ V/m)
30 – 230	10	Quasi Peak / 120 kHz	30
230 – 1000			37



5.1.2. Test Procedures

Tabletop equipment:

- a). The EUT was placed on a rotatable table top 0.8 meter above ground.
- b). The EUT was set 10 meters from the interference-receiving antenna which was mounted on the top of a variable height antenna tower.
- c). The table was rotated 360 degrees to determine the position of the highest radiation.
- d). The antenna is a half wave dipole and its height is varied between one meter and four meters above ground to find the maximum value of the field strength both horizontal polarization and vertical polarization of the antenna are set to make the measurement.
- e). For each suspected emission the EUT was arranged to its worst case and then tune the antenna tower (from 1 M to 4 M) and turn table (from 0 degree to 360 degrees) to find the maximum reading.
- f). Set the test-receiver system to Peak Detect Function and specified bandwidth with Maximum Hold Mode.
- g). If the emission level of the EUT in peak mode was 3 dB lower than the limit specified, then testing will be stopped and peak values of EUT will be reported, otherwise, the emissions which do not have 3 dB margin will be repeated one by one using the quasi-peak method and reported.
- h). The FCC Part 15.109(g) permit parties seeking to authorize a digital device to choose to demonstrate that the device complies with either the Part 15 standards or the international standards found in Publication 22 of the International Special Committee on Radio Interference (CISPR).
- i). If the EUT is having a Wireless modular, can choose to install the filter at the input connector of test-receiver system.

Floor-standing equipment:

- a). The EUT was placed on the horizontal ground reference plane, 12 mm above ground.
- b). The EUT was set 10 meters from the interference-receiving antenna which was mounted on the top of a variable height antenna tower.
- c). The table was rotated 360 degrees to determine the position of the highest radiation.
- d). The antenna is a half wave dipole and its height is varied between one meter and four meters above ground to find the maximum value of the field strength both horizontal polarization and vertical polarization of the antenna are set to make the measurement.
- e). For each suspected emission the EUT was arranged to its worst case and then tune the antenna tower (from 1 M to 4 M) and turn table (from 0 degree to 360 degrees) to find the maximum reading.
- f). Set the test-receiver system to Peak Detect Function and specified bandwidth with Maximum Hold Mode.
- g). If the emission level of the EUT in peak mode was 3 dB lower than the limit specified, then testing will be stopped and peak values of EUT will be reported, otherwise, the emissions which do not have 3 dB margin will be repeated one by one using the quasi-peak method and reported.
- h). The FCC Part 15.109(g) permit parties seeking to authorize a digital device to choose to demonstrate that the device complies with either the Part 15 standards or the international standards found in Publication 22 of the International Special Committee on Radio Interference (CISPR).
- i). If the EUT is having a Wireless modular, can choose to install the filter at the input connector of test-receiver system.

5.1.3. Measurement Results Calculation

The measured Level is calculated using:

$$\text{Corrected Reading (dB}\mu\text{V/m)} = \text{Antenna Factor} + \text{Cable Loss} + \text{Read Level} - \text{Preamp Factor}$$

For example at 125 MHz if the Antenna Factor is 17.24 dB/m, the cable loss is 1.20 dB, the measured voltage is 35.80 dB μ V and the Preamp Factor is 27.18 dB, the signal strength would be calculated:

$$\text{Corrected Reading (dB}\mu\text{V/m)} = 17.24 \text{ dB/m} + 1.20 \text{ dB} + 35.80 \text{ dB}\mu\text{V} - 27.18 \text{ dB} = 27.06 \text{ dB}\mu\text{V/m}$$

Note: If a hybrid antenna is used, the antenna factor shall be the sum of the Antenna Factor + Attenuator Factor.

5.1.4. Typical Test Setup Layout

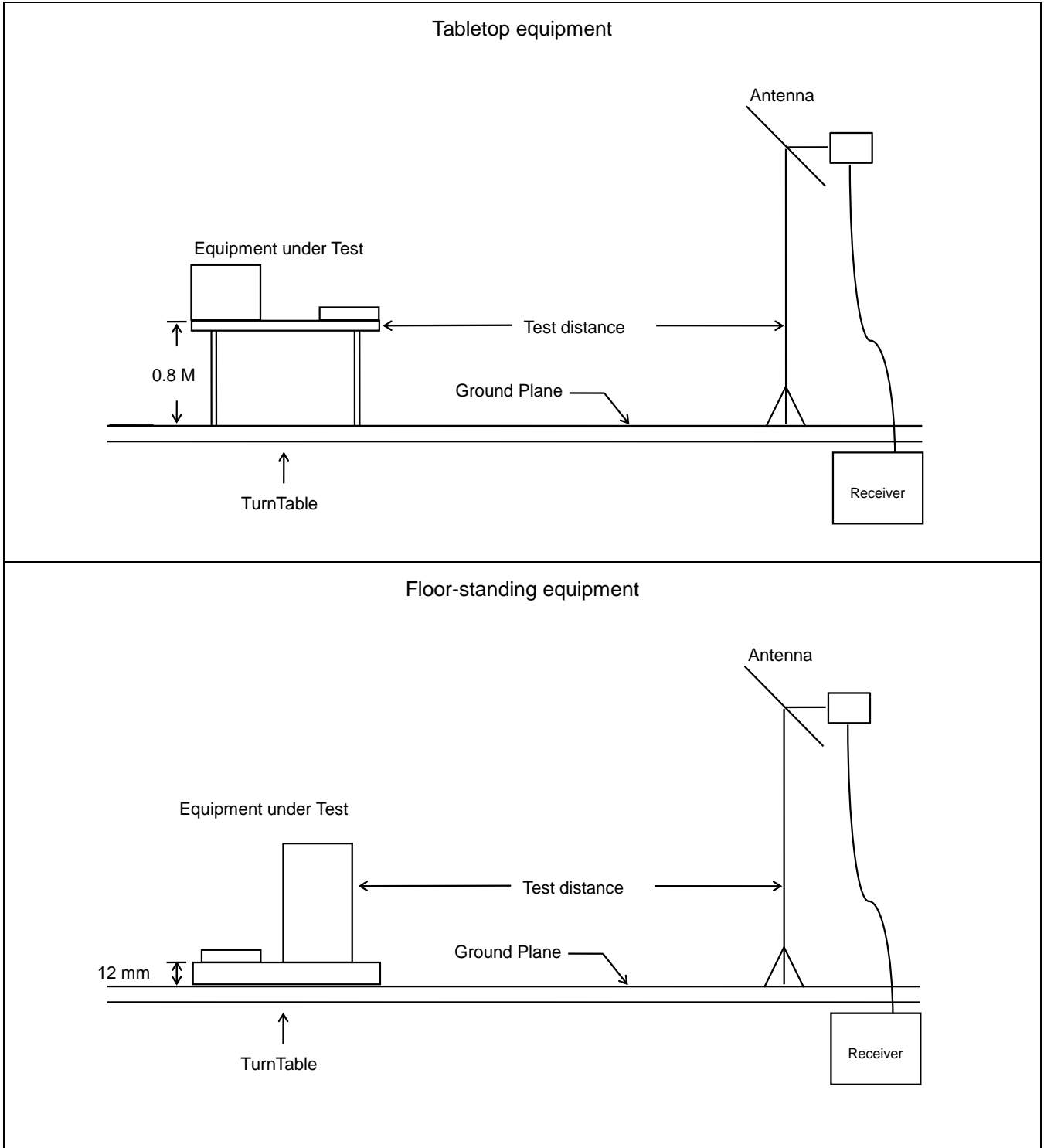



5.1.5. Test Result

Test mode	Mode 1		
Test frequency	30 MHz ~ 1000 MHz	Test Voltage	AC 120V / 60Hz
<p>■ The test was passed at the minimum margin that marked by the frame in the following data</p>			

Vertical

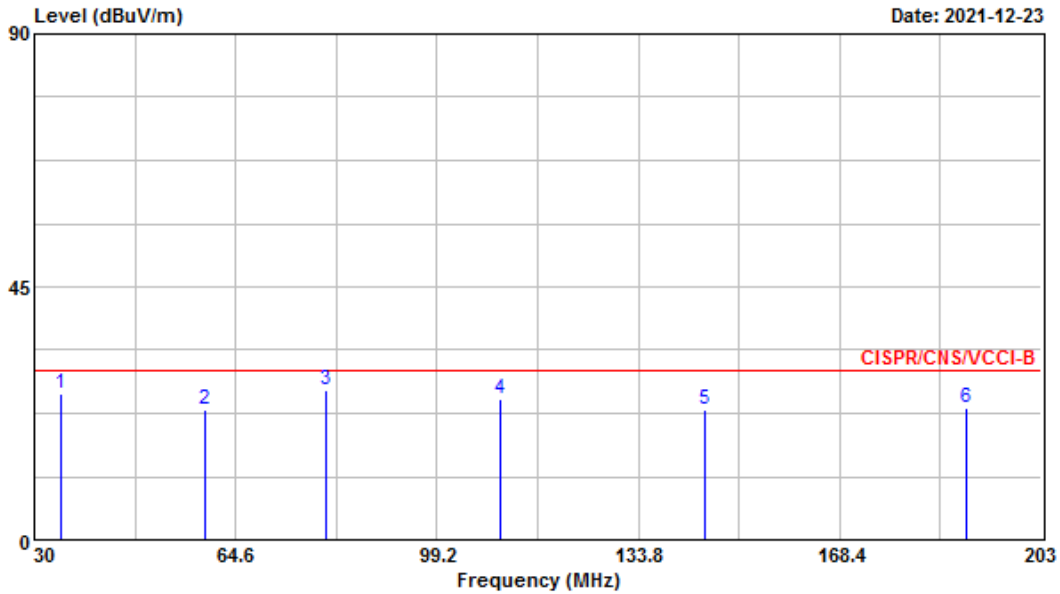

	Freq	Level	Over Limit	Limit Line	ReadAntenna Level	Antenna Factor	Cable Loss	Preamp Factor	Remark	Ant Pos	Table Pos
	MHz	dBuV/m	dB	dBuV/m	dBuV	dB/m	dB	dB		cm	deg
1	34.670	26.13	-3.87	30.00	33.25	20.35	1.00	28.47	QP	---	---
2	59.410	23.19	-6.81	30.00	38.64	11.60	1.40	28.45	Peak	---	---
3	80.170	26.61	-3.39	30.00	41.21	12.11	1.70	28.41	Peak	---	---
4	110.100	24.90	-5.10	30.00	34.06	17.27	1.90	28.33	QP	---	---
5	145.220	23.05	-6.95	30.00	32.84	16.17	2.26	28.22	QP	---	---
6	190.200	23.38	-6.62	30.00	34.33	14.50	2.60	28.05	Peak	---	---



Vertical

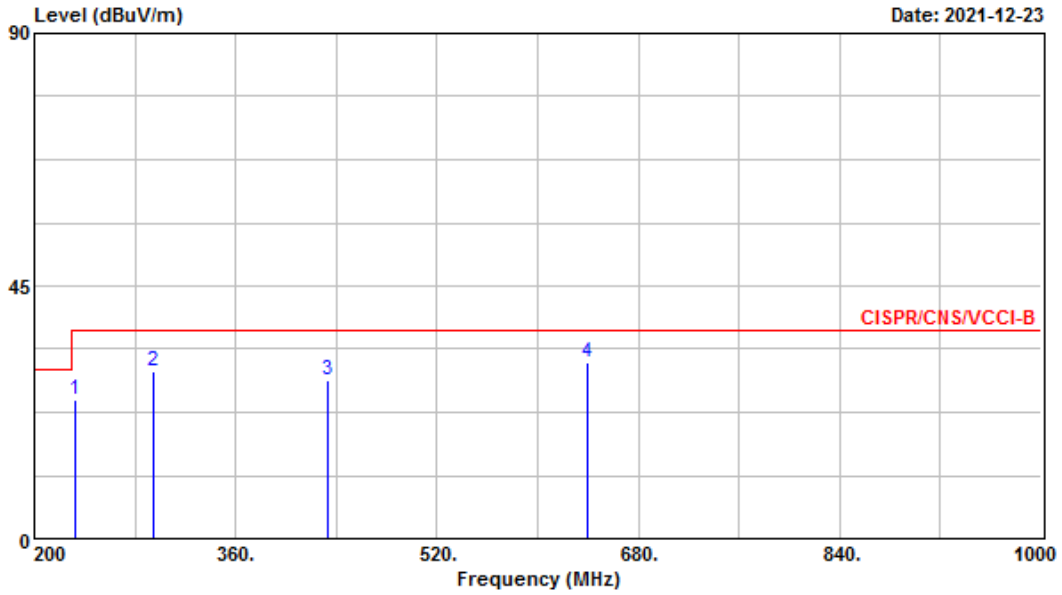

	Freq	Level	Over Limit	Limit Line	ReadAntenna Level	Antenna Factor	Cable Loss	Preamp Factor	Remark	Ant Pos	Table Pos
	MHz	dBuV/m	dB	dBuV/m	dBuV	dB/m	dB	dB		cm	deg
1	232.800	24.60	-12.40	37.00	33.78	15.65	3.03	27.86	Peak	---	---
2	295.200	29.66	-7.34	37.00	35.89	18.32	3.29	27.84	Peak	---	---
3	432.800	28.22	-8.78	37.00	31.17	21.68	4.13	28.76	Peak	---	---
4	640.000	31.32	-5.68	37.00	31.04	23.92	5.54	29.18	Peak	---	---



Horizontal

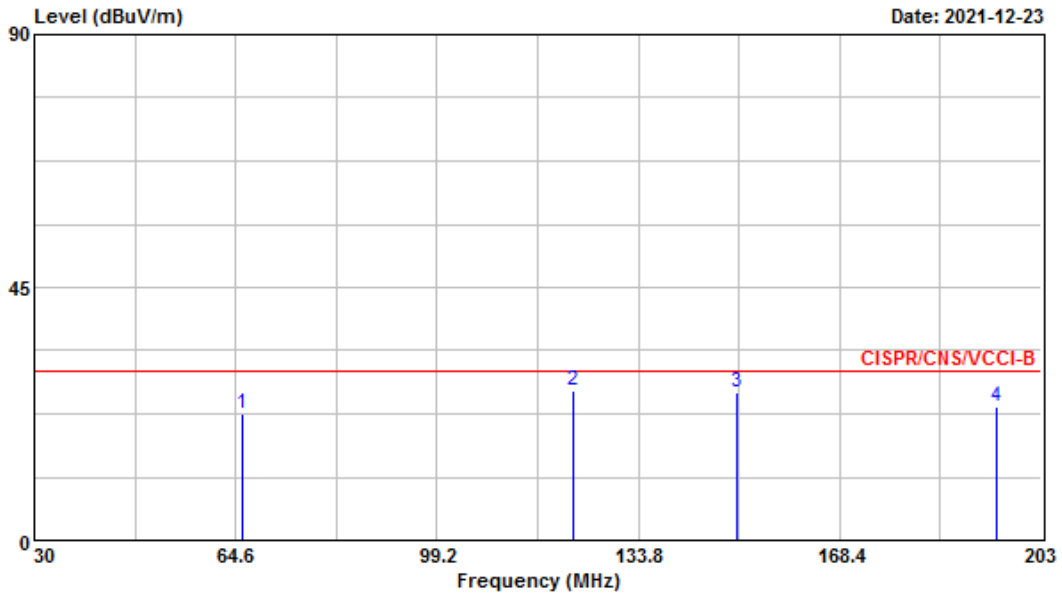

	Freq	Level	Over Limit	Limit Line	ReadAntenna Level	Antenna Factor	Cable Loss	Preamp Factor	Remark	Ant Pos	Table Pos
	MHz	dBuV/m	dB	dBuV/m	dBuV	dB/m	dB	dB		cm	deg
1	65.810	22.54	-7.46	30.00	37.98	11.59	1.42	28.45	Peak	---	---
2	122.560	26.64	-3.36	30.00	35.05	17.87	2.02	28.30	Peak	400	185
3	150.750	26.33	-3.67	30.00	36.41	15.83	2.30	28.21	QP	---	---
4	195.390	23.87	-6.13	30.00	34.80	14.42	2.66	28.01	Peak	---	---



Horizontal

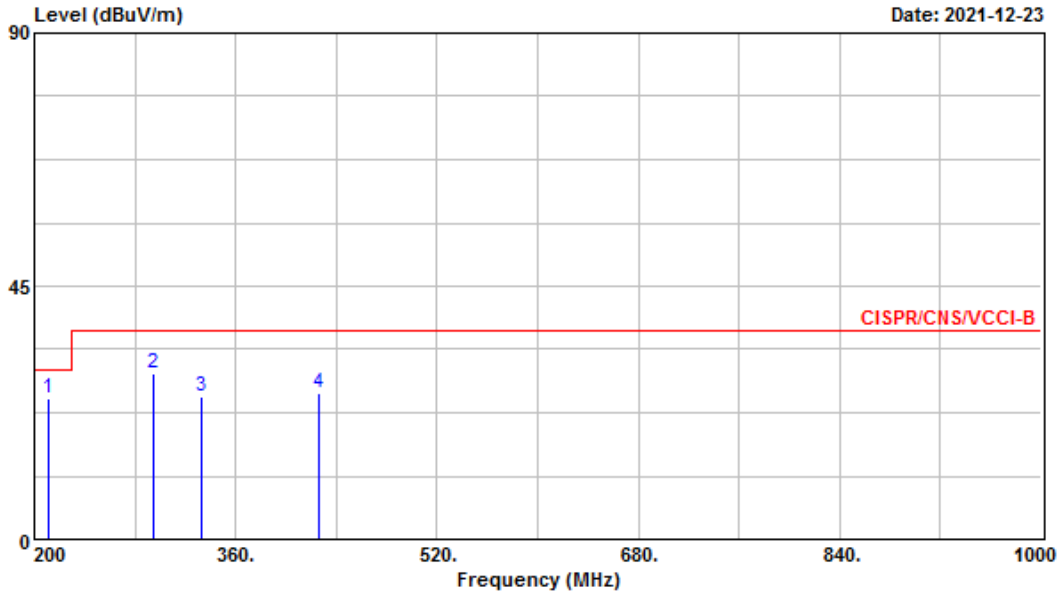

	Freq	Level	Over Limit	Limit Line	ReadAntenna Level	Antenna Factor	Cable Loss	Preamp Factor	Remark	Ant Pos	Table Pos
	MHz	dBuV/m	dB	dBuV/m	dBuV	dB/m	dB	dB		cm	deg
1	212.000	24.93	-5.07	30.00	35.87	14.16	2.83	27.93	Peak	---	---
2	295.200	29.61	-7.39	37.00	35.84	18.32	3.29	27.84	Peak	---	---
3	332.800	25.47	-11.53	37.00	30.72	19.01	3.76	28.02	Peak	---	---
4	425.600	26.11	-10.89	37.00	29.05	21.67	4.10	28.71	Peak	---	---



5.2. Radiated Emission above 1GHz

The EUT is which satisfies the Class B disturbance limits.

5.2.1.Limit

radiated emissions at frequencies above 1 GHz for Class A equipment			
Frequency range GHz	Measurement		Class A limits
	Distance (m)	Detector type / bandwidth	dB(µV/m)
1 – 18	3	Average / 1 MHz	60
1 – 18		Peak / 1 MHz	80
18 – 40	1	Average / 1 MHz	69.54
18 – 40		Peak / 1 MHz	89.54
radiated emissions at frequencies above 1 GHz for Class B equipment			
Frequency range GHz	Measurement		Class B limits
	Distance (m)	Detector type / bandwidth	dB(µV/m)
1 – 18	3	Average / 1 MHz	54
1 – 18		Peak / 1 MHz	74
18 – 40	1	Average / 1 MHz	63.54
18 – 40		Peak / 1 MHz	83.54
<p>Test distance for frequencies at or above 30 MHz, measurements may be performed at a distance other than the limit distance provided they are not performed in the near field and the emissions to be measured can be detected by the measurement equipment. When performing measurements at a distance other than that specified, the results shall be extrapolated to the specified distance using an extrapolation factor of 20 dB/decade (inverse of linear distance for field-strength measurements, inverse of linear distance-squared for power-density measurements).</p> <p>Remark: It should be noted that the field strength is inversely proportional to distance, so the field strength at 3m is 1/3 the strength at 1m, i.e. $L3m/Lx = X/3$. Ex. $L3m\ dB-Lx\ dB = 20\log(3/x)$; $L1m\ dB = 60 + 20\log(3/1) = 69.54\ dB(\mu V/m)$ Ex. $L3m\ dB-Lx\ dB = 20\log(3/x)$; $L1m\ dB = 54 + 20\log(3/1) = 63.54\ dB(\mu V/m)$</p>			

Required highest frequency for radiated measurement	
Highest internal frequency (F_x)	Highest measured frequency
$F_x \leq 108\ MHz$	1 GHz
$108\ MHz < F_x \leq 500\ MHz$	2 GHz
$500\ MHz < F_x \leq 1\ GHz$	5 GHz
$F_x > 1\ GHz$	$5 \times F_x$ up to a maximum of 40 GHz

**5.2.2. Test Procedures**

Tabletop equipment:

- a). Same test set up as below 1GHz radiated testing.
- b). The EUT was set 3m (1 – 18GHz) / 1m (18 – 40GHz) from the interference-receiving antenna which was mounted on the top of a variable height antenna tower.
- c). There should be absorber placed between the EUT and Antenna and its located size should let the test site meet CISPR16-1-4 requirement.
- d). The table was rotated 360 degrees to determine the position of the highest radiation.
- e). The measured using a test-receiver system with both a peak and CISPR average detector.
- f). If the EUT is having a Wireless or Bluetooth modular, can choose to install the filter at the input connector of test-receiver system.
- g). Set the DRG Horn Antenna at 1M height, then run the turn table to get the maximum noise reading from Horizontal and Vertical polarity separately the test-receiver system to Peak Detect Function and specified bandwidth with Maximum Hold Mode.
- h). When EUT locating on the turn-table, and its height is over 172cm (Antenna's 3dB beam width of 6GHz is 27°), the DRG Horn Antenna must be raised up and descended down, while keeping the antenna in the cone of radiation from that area and pointed at the area both in azimuth and elevation, then turning around the turn-table to get the maximum noise reading of the Horizontal and Vertical polarity separately.
- i). If emission level of the EUT in peak mode was 23dB lower than average limit (that means the emission level in peak mode also complies with the limit in average mode), then testing will be stopped and peak values of EUT will be reported, otherwise, the emissions will be measured in average mode again and reported.

Floor-standing equipment:

- a). Same test set up as below 1GHz radiated testing.
- b). The EUT was set 3m (1 – 18GHz) / 1m (18 – 40GHz) from the interference-receiving antenna which was mounted on the top of a variable height antenna tower.
- c). There should be absorber placed between the EUT and Antenna and its located size should let the test site meet CISPR16-1-4 requirement.
- d). The table was rotated 360 degrees to determine the position of the highest radiation.
- e). The measured using a test-receiver system with both a peak and CISPR average detector.
- f). If the EUT is having a Wireless or Bluetooth modular, can choose to install the filter at the input connector of test-receiver system.
- g). Set the DRG Horn Antenna at 1M height, then run the turn table to get the maximum noise reading from Horizontal and Vertical polarity separately the test-receiver system to Peak Detect Function and specified bandwidth with Maximum Hold Mode.
- h). When EUT locating on the turn-table, and its height is over 172cm (Antenna's 3dB beam width of 6GHz is 27°), the DRG Horn Antenna must be raised up and descended down, while keeping the antenna in the cone of radiation from that area and pointed at the area both in azimuth and elevation, then turning around the turn-table to get the maximum noise reading of the Horizontal and Vertical polarity separately.
- i). If emission level of the EUT in peak mode was 23dB lower than average limit (that means the emission level in peak mode also complies with the limit in average mode), then testing will be stopped and peak values of EUT will be reported, otherwise, the emissions will be measured in average mode again and reported.

5.2.3. Measurement Results Calculation

The measured Level is calculated using:

Corrected Reading (dB μ V/m) = Raw(Read Level)+AF(Antenna Factor)+CL(Cable Loss)-PA(Preamp Factor)

For example at 1980 MHz if the Antenna Factor is 26.19 dB/m, the cable loss is 4.08 dB, the measured voltage is 51.30 dB μ V and the Preamp Factor is 33.34 dB, the signal strength would be calculated:

Corrected Reading (dB μ V/m) = 51.30 dB μ V + 26.19 dB/m + 4.08 dB - 33.34 dB = 48.23 dB μ V/m

Note: If a Band reject filter is used, this factor will be added to the sum of the factors.

5.2.4. Typical Test Setup Layout

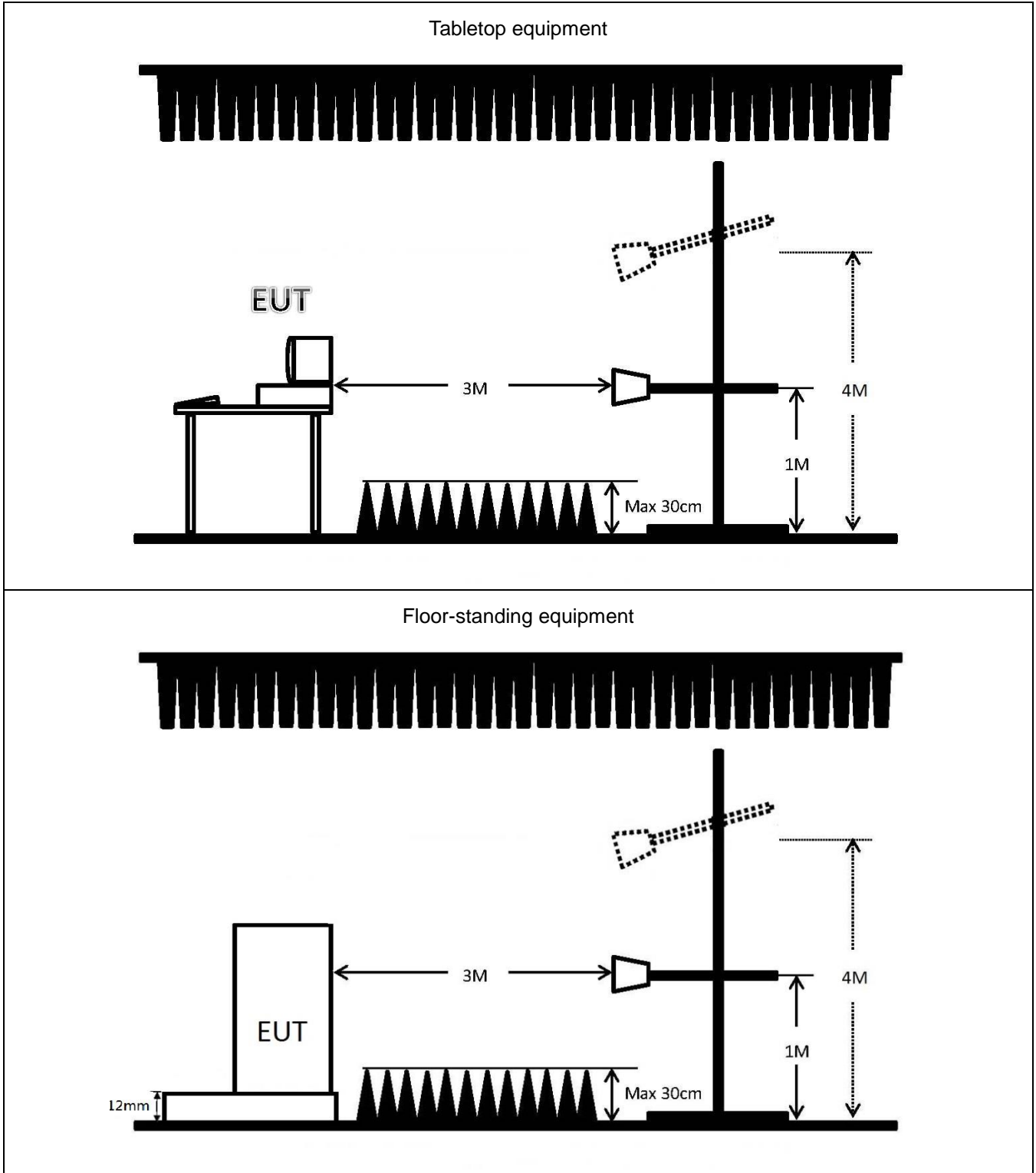



5.2.5. Test Result

Test mode	Mode 1		
Test frequency	Above 1GHz	Test Voltage	AC 120V / 60Hz
<p>■ The test was passed at the minimum margin that marked by the frame in the following data</p>			

Vertical

Mode 1

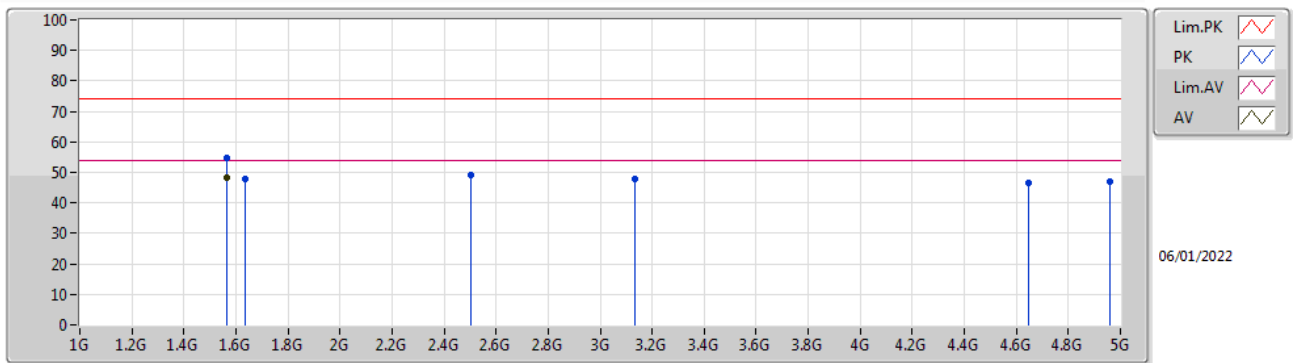

Type	Freq (Hz)	Level (dBuV/m)	Limit (dBuV/m)	Margin (dB)	Factor (dB/m)	Dist (m)	Condition	Azimuth (°)	Height (m)	Comment	Raw (dBuV)	AF (dB/m)	CL (dB)	PA (dB)
PK	1.565G	54.60	74.00	-19.40	-5.87	3	Vertical	194	1	-	60.47	25.80	3.63	35.30
AV	1.565G	48.34	54.00	-5.66	-5.87	3	Vertical	194	1	"Worst"	54.21	25.80	3.63	35.30
PK	1.635G	47.99	74.00	-26.01	-5.82	3	Vertical	-	-	-	53.81	25.73	3.72	35.27
PK	2.505G	49.34	74.00	-24.66	-3.06	3	Vertical	-	-	-	52.40	27.70	4.33	35.09
PK	3.135G	47.64	74.00	-26.36	-2.04	3	Vertical	-	-	-	49.68	28.91	4.16	35.11
PK	4.645G	46.56	74.00	-27.44	2.41	3	Vertical	-	-	-	44.15	31.08	6.04	34.71
PK	4.96G	47.08	74.00	-26.92	3.43	3	Vertical	-	-	-	43.65	31.52	6.48	34.57



Horizontal

Mode 1

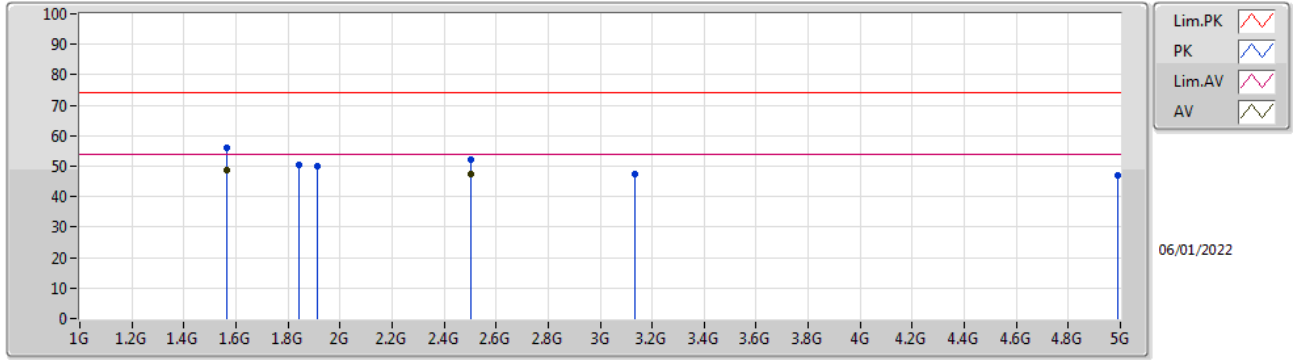

Type	Freq (Hz)	Level (dBuV/m)	Limit (dBuV/m)	Margin (dB)	Factor (dB/m)	Dist (m)	Condition	Azimuth (°)	Height (m)	Comment	Raw (dBuV)	AF (dB/m)	CL (dB)	PA (dB)
PK	1.565G	56.00	74.00	-18.00	-5.87	3	Horizontal	221	1	-	61.87	25.80	3.63	35.30
AV	1.565G	48.69	54.00	-5.31	-5.87	3	Horizontal	221	1	"Worst"	54.56	25.80	3.63	35.30
PK	1.84G	50.49	74.00	-23.51	-5.32	3	Horizontal	-	-	-	55.81	25.98	3.88	35.18
PK	1.915G	49.80	74.00	-24.20	-4.79	3	Horizontal	-	-	-	54.59	26.45	3.91	35.15
PK	2.505G	52.34	74.00	-21.66	-3.06	3	Horizontal	1	1	-	55.40	27.70	4.33	35.09
AV	2.505G	47.61	54.00	-6.39	-3.06	3	Horizontal	1	1	-	50.67	27.70	4.33	35.09
PK	3.135G	47.41	74.00	-26.59	-2.04	3	Horizontal	-	-	-	49.45	28.91	4.16	35.11
PK	4.99G	47.14	74.00	-26.86	3.56	3	Horizontal	-	-	-	43.58	31.58	6.53	34.55



6. Uncertainty of Test Site

ISO/IEC 17025 requires that an estimate of the measurement uncertainties associated with the emissions test results be included in the report. The measurement uncertainties given below are based on a 95% confidence level (based on a coverage factor (k=2)).

6.1. Measurement Uncertainty

Test Items	Test Site No.	U_{LAB}
Conducted Emissions	CO01-NH	2.66 dB
Radiated Emissions below 1GHz	OS03-NH	5.07 dB
Radiated Emissions above 1GHz	03CH04-HY	3.53 dB



7. List of Measuring Equipment Used

Conducted Emission - Test Date: 23/Dec/2021

Instrument	Manufacturer/Brand	Model No.	Serial No.	Characteristics	Calibration Date	Calibration Due Date	Remark
EMI Receiver	R&S	ESR	102318	9kHz - 3.6GHz	26/Jul/2021	25/Jul/2022	Conduction (CO01-NH)
LISN	SCHAFFNER	NNB41	06/10024	9kHz - 30MHz	28/Dec/2020	27/Dec/2021	Conduction (CO01-NH)
LISN (Support Unit)	MessTec	NNB-2/16Z	99079	9kHz - 30MHz	03/Feb/2021	02/Feb/2022	Conduction (CO01-NH)
Power Filter	CORCOM	MR12030	N/A	30A*2	NCR	NCR	Conduction (CO01-NH)
RF Cable-CON	Suhner Switzerland	RG223/U	CB004	9kHz - 30MHz	25/Dec/2020	24/Dec/2021	Conduction (CO01-NH)
software	Audix	E3	6.12160806	-	NCR	NCR	Conduction (CO01-NH)

NCR: No Calibration Required

Radiated Emission below 1GHz - Test Date: 23/Dec/2021

Instrument	Manufacturer/Brand	Model No.	Serial No.	Characteristics	Calibration Date	Calibration Due Date	Remark
Open Area Test Site	SPORTON	OATS-10	OS03-NH	30MHz - 1GHz 10m, 3m	16/Oct/2021	15/Oct/2022	Radiation (OS03-NH)
Amplifier	HP	8447D	2944A08292	0.1MHz - 1.3GHz	02/Jul/2021	01/Jul/2022	Radiation (OS03-NH)
Spectrum Analyzer	R&S	FSP7	838858/038	9kHz - 7GHz	21/Jun/2021	20/Jun/2022	Radiation (OS03-NH)
Receiver	R&S	ESCS30	100357	9kHz - 2.75GHz	07/May/2021	06/May/2022	Radiation (OS03-NH)
Bilog Antenna With 5dB Attenuator	CHASE	CBL6112D	25234	30MHz - 2GHz	24/Apr/2021	23/Apr/2022	Radiation (OS03-NH)
Turn Table	EMCO	2080	9805-2065	0 - 360 degree	NCR	NCR	Radiation (OS03-NH)
Antenna Mast	EMCO	2075	9804-2151	1 m - 4 m	NCR	NCR	Radiation (OS03-NH)
RF Cable-R10m	HSCN	RG213U	2X11N	30MHz - 1GHz	13/Jul/2021	12/Jul/2022	Radiation (OS03-NH)
Software	Audix	E3	Ver.4	-	NCR	NCR	Radiation (OS03-NH)

NCR: No Calibration Required

Radiated Emission above 1GHz - Test Date: 06/Jan/2022

Instrument	Manufacturer/Brand	Model No.	Serial No.	Characteristics	Calibration Date	Calibration Due Date	Remark
EMI Test Receiver	R&S	ESU-26	100422	20Hz ~ 26.5GHz	05/Nov/2021	04/Nov/2022	Radiation (03CH04-HY)
3m Semi Anechoic Chamber (Site V.S.W.R)	RIKEN	3m SAC	03CH04-HY	1 GHz ~ 18 GHz 3m	19/Feb/2021	18/Feb/2022	Radiation (03CH04-HY)
Microwave Preamplifier	Agilent	8449B	3008A02602	1GHz~26.5GHz	19/Mar/2021	18/Mar/2022	Radiation (03CH04-HY)
Horn Antenna	SCHWARZBECK	BBHA9120	BBHA9120D01834	1 GHz ~ 18 GHz	23/Feb/2021	22/Feb/2022	Radiation (03CH04-HY)
RF Cable	SUHNER	SUCOFLEX 104	CB001-03CH01	30MHz~18GHz	25/Feb/2021	24/Feb/2022	Radiation (03CH04-HY)
Turn Table	Chaintek	3000	MF7802056	0 ~ 360 degree	NCR	NCR	Radiation (03CH04-HY)



Antenna Mast	MF	MFA-515BSN	MF780208193	1 ~ 4 m	NCR	NCR	Radiation (03CH04-HY)
Software	Sporton	SENSE-EMI	V5.10.7	-	NCR	NCR	Radiation (03CH04-HY)

NCR: No Calibration Required

Appendix A. Test Photos

1. Photographs of Conducted Emissions Test Configuration

Front View

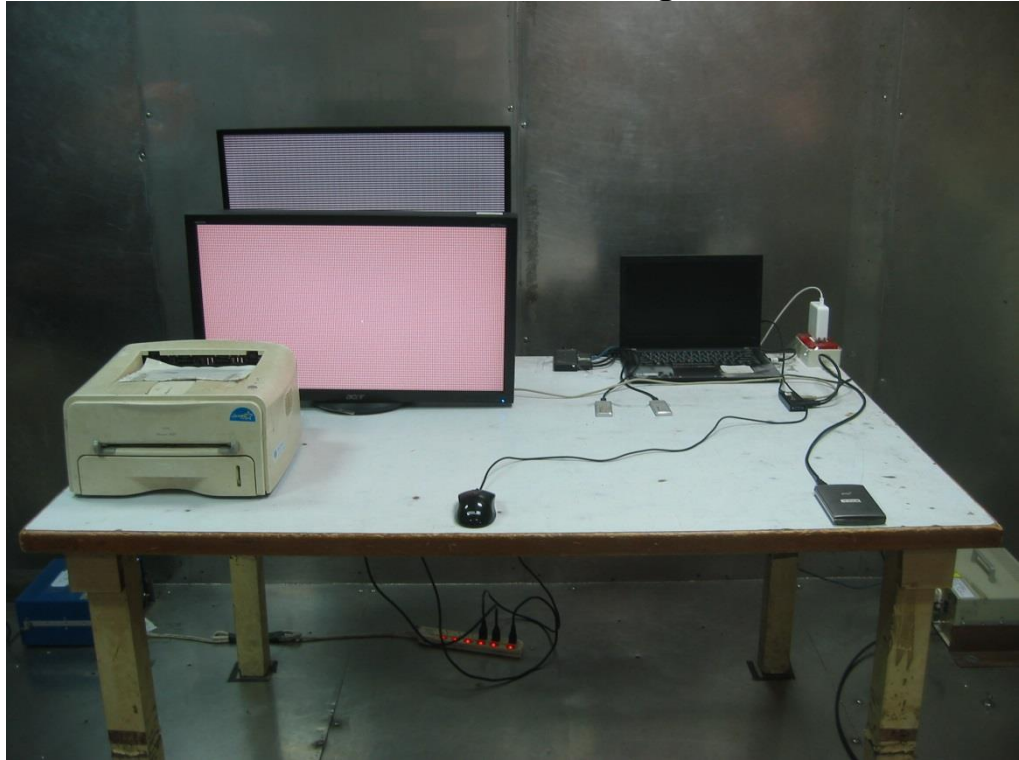

Side View

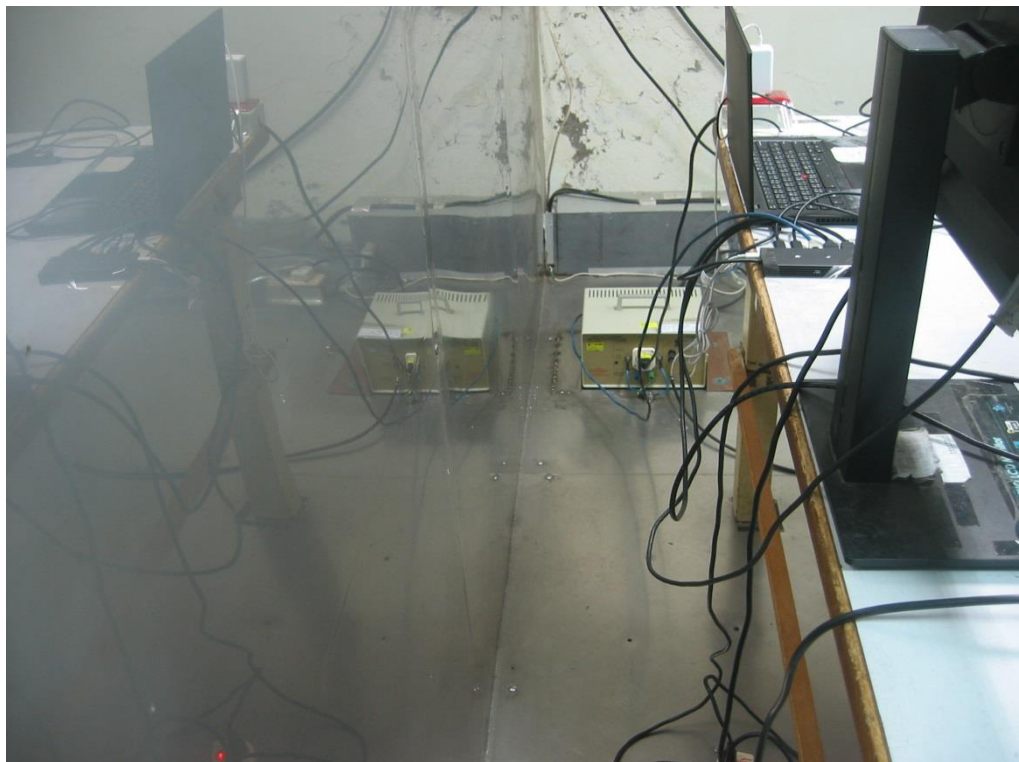

Under Table View

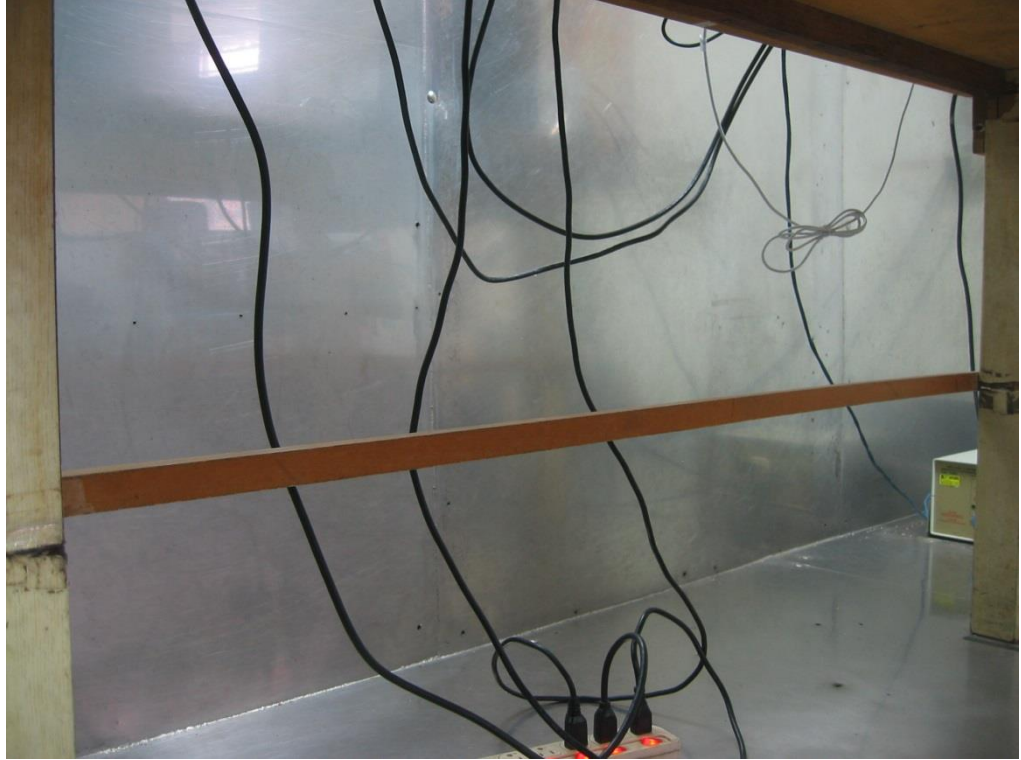

2. Photographs of Radiated Emissions Test Configuration

For radiated emissions below 1GHz

Front View



Rear View

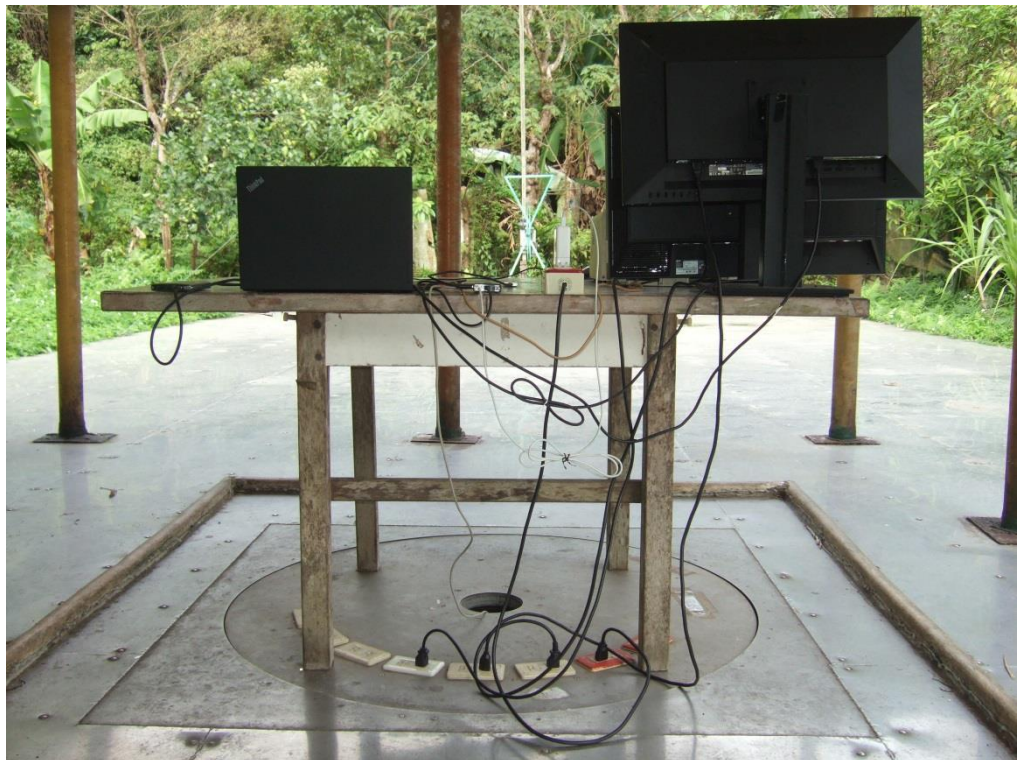

For radiated emissions above 1GHz

Front View



Rear View

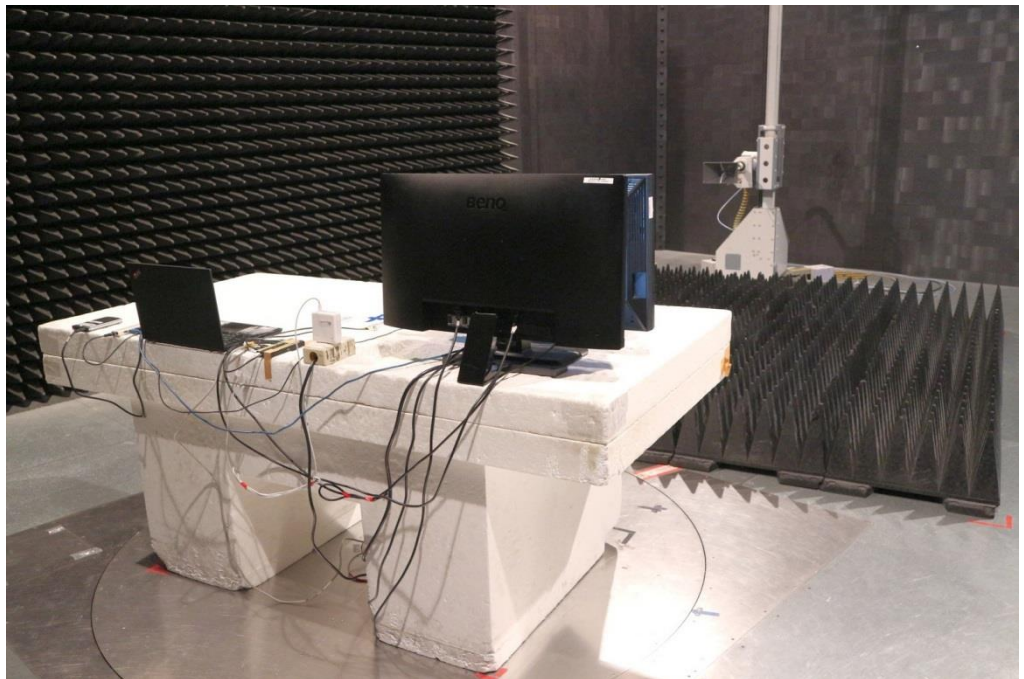

————THE END————