

Drayton

by Schneider Electric

Wiser™

INSTALLATION Guide

Wiser Thermostat Kit 1

Wiser Thermostat Kit 2

Wiser Thermostat Kit 3

Wiser Multi-zone Kit 1

Wiser Multi-zone Kit 2



Phone: 0333 6000 622*

Website: wiser.draytoncontrols.co.uk

E-mail: customer.care@draytoncontrols.co.uk

 @DraytonHome

 /DraytonHome

*Please note that international call charges may apply to those calling from outside of the UK.

Installer Guide 06490238001 IssL



Introduction

Welcome!

Save this guide for future reference.

If you are replacing an existing controller/programmer and don't need to make any wiring changes that's great news. All you need to do is remove the old product and fit your new Wiser Hub^R to the existing wallplate.

If you are fitting a new system or require re-wiring please contact an installer.

⚠ IMPORTANT:

Do not attempt to install this product if you are not familiar with how to install mains-powered electrical appliances.

Always switch off the mains before removing a controller and never fit it to a live wallplate.

Step 1: Mounting the wallplate



Step 1 Continued...

Option 1: Fitting a new wallplate

The ideal location should have reasonable lighting, good access, no condensation, no extremes of temperature and a supporting surface that fully covers the back of the unit.

Position with 70mm clearance to the right, 25mm above and sufficient room to access the securing screws underneath. Fix, with terminals at the top, either direct to a flat wall using wall plugs and No. 6 x 1" (25mm) woodscrews, or on a flush mounting single conduit box type UA1 (BS4662) using M3.5 x 14 bolts. Now fit the Wiser Hub^R onto the wallplate and tighten the securing screws. Check the 3A fuse, and switch on the mains.

Option 2: Using an existing industry standard wallplate

Loosen the securing screws on the old controller/ programmer and unplug it. Check that there is 70mm clearance to the right of the wallplate and 25mm above it. Check the wiring diagram for your product model to compare terminals and, if necessary, change the wiring of the wallplate to suit. Now fit the Wiser Hub^R onto the wallplate and tighten the securing screws.

Check the 3A fuse, and switch on the mains.

⚠ DO NOT use a surface mounting box as the wallplate is not designed for this purpose.

Note: Ensure the Hub^R is installed in a position with WiFi coverage.

Step 2a: Wiring - wallplate



Make sure mains Input has a 3 amp fuse.

CAUTION! Before Installation, make sure the mains supply is switched off!

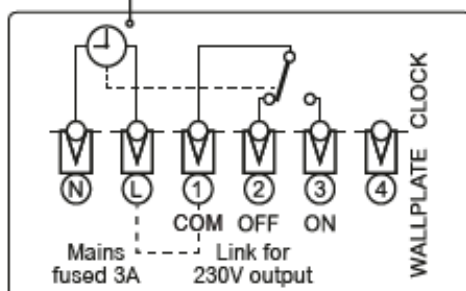
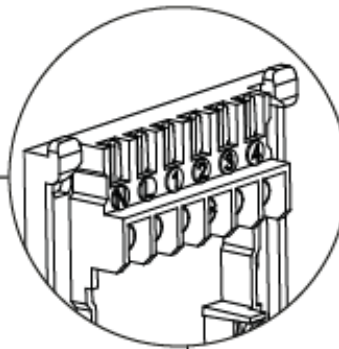

One Channel:
WT714R and WV714R

One channel only: Note that the output contacts are voltage-free*, so power needs to be put on to Terminal 1 either by linking from Terminal L or from a separate supply with a 3A fuse.

* Not SELV - Fixed wiring only, to comply with current IET regulations.

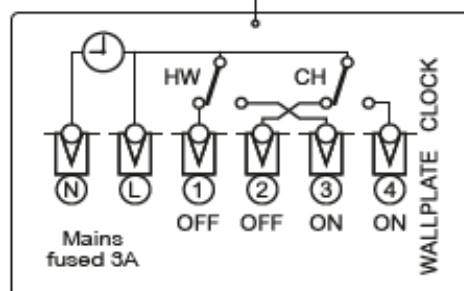

Two Channel:
WT724R and WV724R

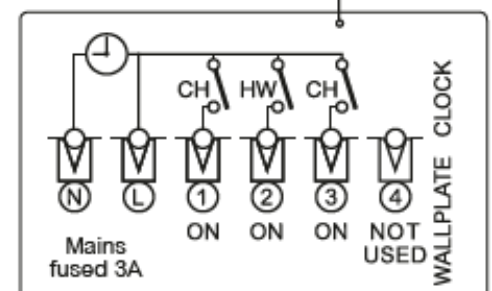

Three Channel:
WT734R

Three channel only: Make a note of which circuit is connected to CH1 and CH3 respectively as this information is needed later, during commissioning, when room thermostats are added to the system.

Note: If there is an existing wired thermostat connected via the wallplate, you can:

- Disconnect it i.e. remove the thermostat wires from the wallplate, or
- Leave the thermostat connected providing it is ON and there are no schedules that can interfere with Wiser, or
- Turn the existing room stat up to max. This is the same as creating a permanent supply through the LIVE-IN and SWITCH-LIVE.

Note: After wiring, fit the Wiser Hub^R onto the wallplate and tighten the securing screws. Check the 3A fuse and switch on the mains.

Step 2b: Wiring - boiler with OpenTherm interface

If your boiler supports OpenTherm, please follow the instructions under this step.

Existing OpenTherm installation

1. Remove the OpenTherm cables from the existing controller or thermostat.
2. Remove the OpenTherm module from the rear of the Wiser Hub^R.
3. Wire in the OpenTherm cables into the OpenTherm module. It does not matter which way the cables are wired.
4. Replace the OpenTherm module into the Hub^R.
5. Wire L & N on the wallplate from a separate supply with a 3A fuse.
6. Mount the Hub^R on the wallplate.

The Wiser Hub^R is an OpenTherm certified product and will therefore operate with OpenTherm certified boilers. Currently The Hub^R is not compatible with boilers that require a temperature for domestic hot water to be provided by the external heating controls. For more information about wiring options please consult the digital user guide found on wiser.draytoncontrols.co.uk/support



Step 3: Testing the system

Heating and Hot Water buttons

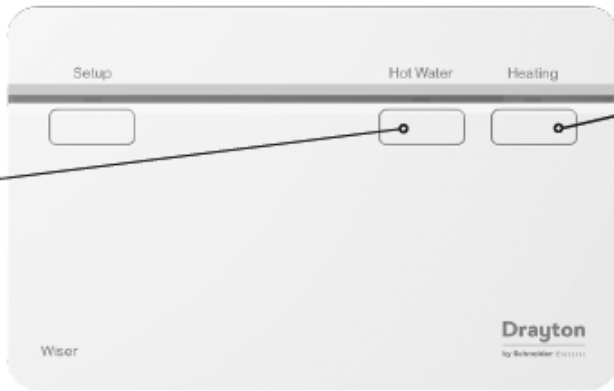

Hot Water override button (WV724R, WT724R & WT734R only)

Pressing & holding the Hot Water button for >3s will turn on the Hot Water for 1 hour. In this state the hot water will be regulated by a cylinder thermostat or the boiler. When the Hot Water override is active, the Hot Water LED will flash green. To turn off the override press the Hot Water button again. This will put the hot water back under system control. Depending on the system settings the hot water may stay on which will be indicated by a solid green LED.

Tip: This feature can be used to 'test' an installation prior to adding any devices.

Note: The heating and hot water button override states are not shown in the app. These act as a fall back state in the event that other controls are unavailable.

Heating override button

Pressing & holding the Heating button for >3s will turn on the heating for 2 hours. In this state the boiler will self-regulate its temperature. When the Heating override is active, the Heating LED will flash green. To turn off the override press the Heating button again. This will put the heating back under system control. Depending on the system settings the heating may stay on which will be indicated by a solid green LED.

Connection Charts



Always switch off the mains before removing the Wisser Hub^R - and never fit it to a live wallplate!

Make the wiring connections, as shown in the connection charts, for the appropriate system. For surface wiring, snap out the cable entry strip on the bottom edge of the wallplate. The Wisser Hub^R is double-insulated and needs no earth connection, but an earthing continuity (loop) terminal is provided for convenience.

Note: If there is an existing wired thermostat, it must be completely disconnected, i.e. remove the thermostat wires from the wiring centre - a link must be inserted between the terminals where the thermostat common and call for heat wires are located in the wiring centre.

Arrowed numbers relate to the junction box.

*** Consult boiler handbook for details of pump overrun wiring.**

After wiring, clip on the unit and tighten the securing screws. Check the mains input has a 3A fuse, and switch on the mains.

LS = Live Supply
LR = Live Return

Connection Charts

LWC3 Junction Box



Programmer



Boiler



Mains Input - 230V a.c.

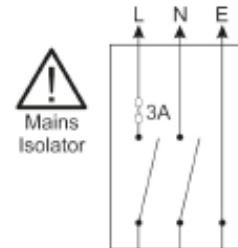

Single Zone CombiBoiler: Model WT714R, WV714R

LWC3 Junction Box

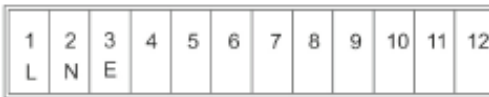

Programmer

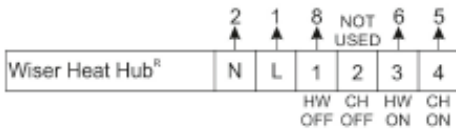

Pump



Boiler



Cyl. Thermostat

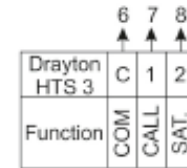

Mains Input - 230V a.c.

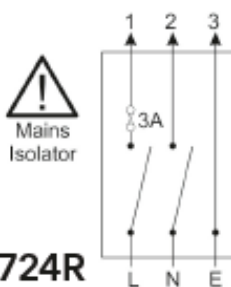

Motorised Valve

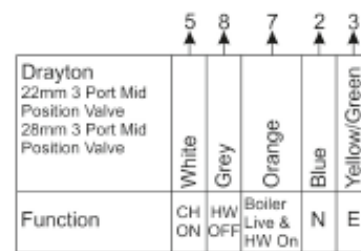

Biflo system: Model WT724R, WV724R

Connection Charts

LWC3 Junction Box



Pump



Boiler



Cyl. Thermostat

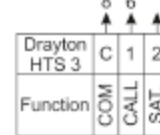

Programmer

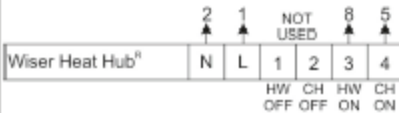

Mains Input - 230V a.c.

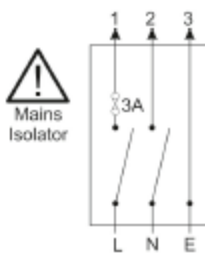

Motorised Valve

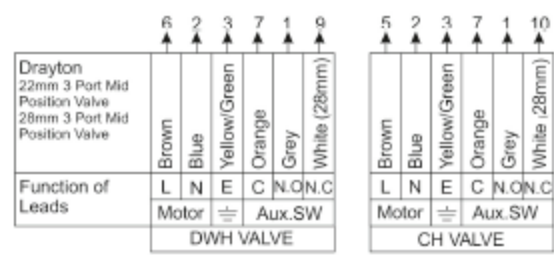

Twinzone system: Model WT724R, WV724R

* The white wire (28mm Valves) becomes live when the valve closes, it is not used and is wired to 'spare' terminal for safe isolation.

LWC1 Wiring Centre

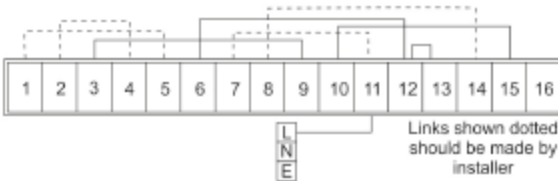

Pump



Boiler



Cyl. Thermostat

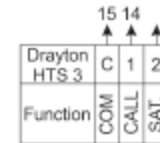

Programmer

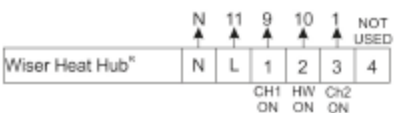

Mains Input - 230V a.c.

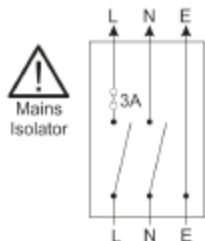

Motorised Valve

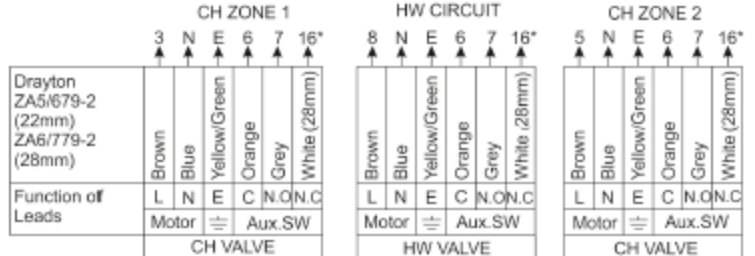

3 Zone system: Model WT734R

* The white wire (28mm Valves) becomes live when the valve closes, it is not used and is wired to 'spare' terminal for safe isolation.

Step 4: Download the app

In order to continue the installation you will need to download the Wisier Heat app for your smartphone.



App Store:
[https://
apps.apple.com/us/
app/wiser-heat/
id1222853887](https://apps.apple.com/us/app/wiser-heat/id1222853887)



Google Play:
[https://
play.google.com/
store/apps/details?
id=com.schneider_ele
ctric.WiserHeat](https://play.google.com/store/apps/details?id=com.schneider_electric.WiserHeat)

Wiser Room Thermostat

Thermostat Kits 1, 2 & 3:

For room thermostat only systems the positioning is important as this will control the boiler to your entire home. In these systems mechanical TRVs should be used as a minimum to provide a level of room heating control.

For optimum comfort and savings, each radiator in your home should be fitted with a Wiser Radiator Thermostat. These can be purchased and installed individually.

Boost

Feeling a bit cool?

1. Go to the Room Thermostat and touch any button to wake it up.
2. Touch the centre button again to activate boost 1st touch = 30 minutes,
2nd touch = 1 hour
3rd touch = 2 hours,
4th touch = 3 hours
5th touch = Cancel
3. Shortly after the room will start to warm.

Note: A boost will increase the setpoint to 2°C above the ambient temperature for the time period selected. You can still adjust the setpoint when boosted.

Wiser Radiator Thermostat

Multi-zone System:

Economy use:

- Place the Room Thermostat in a room which is heated most of the time, typically the lounge/hallway.
- Place the Radiator Thermostat(s) in rooms that are not used all day such as bedrooms.
- The room with Radiator Thermostats can now be scheduled separately to avoid heating them with the rest of the rooms.

For optimum comfort and savings, each radiator in your home should be fitted with a Wiser Radiator Thermostat. These can be purchased and installed individually.

Mounting Options

As radiator valve bodies are not all the same, Wiser Radiator Thermostats come with two valve adapters; M30x1.5mm and Danfoss RA (if however, neither work with your radiator valves, consult the Valve Adapter Guide on the Drayton website).

First remove the old thermostatic head from the valve body. Water should not leak from the valve whilst doing this. (Refer to the manufacturer's instructions if needed.) You are now ready to install your new Wiser Radiator Thermostat.



Note: Turning the head to the highest position/number will simplify de-installation

Once you have set up your Radiator Thermostat(s) through the app, you will be asked to select and fit the required adapter. When fitting and tightening the adapter to the Radiator Thermostat, please make sure that the O-ring is firmly seated above the thread as to avoid damaging the O-ring. Tighten by hand only.

Fitting M30x1.5mm

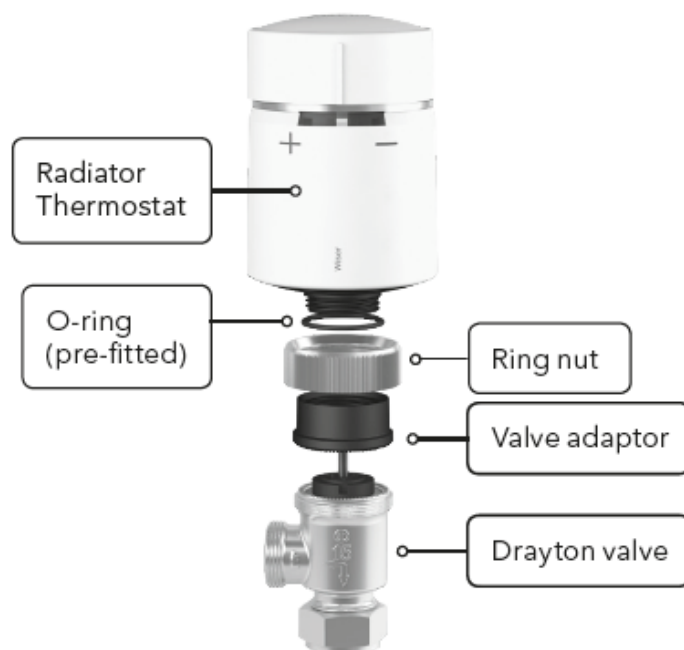

Place the small black plastic adapter serrated face down onto the valve. Position the metal ring nut over the black plastic adapter and screw it onto the valve. Now screw the Radiator Thermostat onto the black plastic adapter until tight. If the Radiator Thermostat is not facing the right direction, slacken the metal ring nut and rotate the Radiator Thermostat as required and re-tighten the metal ring nut.

Thermostatic head calibration

Upon fitting of the relevant valve adapter, twist the cap of the Radiator Thermostat in the - direction for 2 seconds until the right LED shows a solid blue.

Wiser Radiator Thermostat

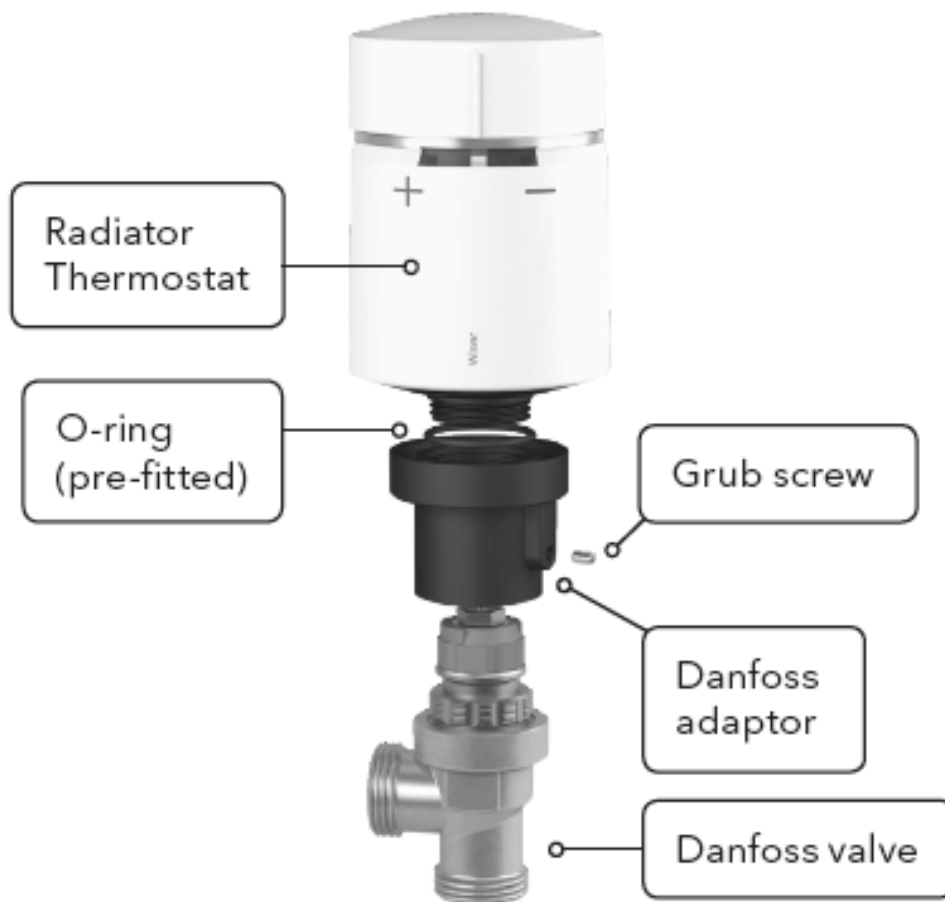

Slide the larger black plastic adapter small end first over the valve. Make sure that the hole containing the grub screw is facing away from you. This way, once its mounted, the markings of the Radiator Thermostat will be in the required position. Use an appropriate size Allen key to tighten the grub screw. Now screw the Radiator Thermostat onto the larger black plastic adaptor until tight.

Thermostatic head calibration

Upon fitting of the relevant valve adapter, twist the cap of Radiator Thermostat in the - direction for 2 seconds until the right LED shows a solid blue.

IMPORTANT:

To limit temperature in other rooms use existing thermostatic radiator heads. We suggest regulating these according to manufacturer's documentation to provide either economy or comfort use

Boost

Feeling a bit cool?

1. Go to the Radiator Thermostat and twist the cap in the + direction.
2. The left LED will show a solid red for 5 seconds and then disappear.

3. Shortly after the room will start to warm.

Note: A boost + will increase the setpoint by 2°C above the ambient temperature for 1 hour.

Feeling a bit warm?

1. Go to the Radiator Thermostat and twist the cap in the - direction.
2. The right LED will show a solid blue for 5 seconds and then disappear.
3. Shortly after the Radiator Thermostat will close the valve and stop the hot water flow to the radiator.

Note: A boost - will decrease the setpoint by 2°C below the ambient temperature for 1 hour.

ErP Rating

	ErP Class with Modulating boiler	ErP rating	ErP Class with on/off boiler	ErP rating
Wiser Thermostat Kit 1	VI	4%	VII	3.5%
Wiser Thermostat Kit 2	VI	4%	VII	3.5%
Wiser Thermostat Kit 3	VI	4%	VII	3.5%
Wiser Multi-zoning Kit 1	VIII	5%	VII	3.5%
Wiser Multi-zoning Kit 2	VIII	5%	VII	3.5%

Technical Data

	Wiser Heat Hub ^R	Wiser Room Thermostat	Wiser Radiator Thermostat
Dimensions	93mm(w), 148mm(h), 31mm(d)	76mm(w), 76mm(h), 25mm(d)	93mm(h), 51mm(dia)
Power Supply	230V a.c. ±10% 50Hz	2x1.5V IEC LR6 (AA) alkaline batteries	
Switch Rating	2(1)A 230V a.c. each switch Total load must not exceed 2.5A	N/A	
Wiring	Fixed wiring only, to comply with current IET regulations (BS7671)	No wiring required	
Interfaces	User: Push Button/LED; I/O: Mains Relays (1-3), Digital Boiler Interface	User: TFT display, touch buttons; I/O: None	User: Twist Cap, LED; I/O: None
	0°C to 45°C		
Storage Temperature	-10°C to 55°C		
Maximum Mounting Surface Temperature	N/A		93°C
Maximum Water Temperature	N/A		73°C continuous and 110°C max
Ingress Protection	IP 30	IP 20	IP 30
Ambient Humidity (non-condensing)	Operating 25% to 90%, Storage 15% to 95%		
Set-point Range	5°C to 30°C		
Control Accuracy	<0.6°C at 4°C/hour (with Room Thermostat)	N/A	
	<0.8°C at 4°C/hour (with Radiator Thermostat)	N/A	
Timing Resolution	1 minute		
Temperature Resolution	0.5°C		
Ball Pressure Test Temperature	78°C	75°C	
Pollution Degree	2		
Software Class	A		
Without Mains Power	Display: LEDs off; Time: always kept; Program times: always preserved	N/A	
Rated Impulse Voltage	2.5kV		
Radio Technology/Frequency	2.4GHz (Bi-directional, Mesh)		
Radio Signal Range	30m Free Space		
Maximum Radio-Frequency Power Transmitted	+17dBm (50mW)	+13dBm (20mW)	+13dBm (20mW)
Mounting	Industry standard wall plate	Wall bracket or desk stand	Radiator Valve
Relevant Directives	Radio Equipment Directive (RED) 2014/53/EU, Batteries Directive 2006/66/EC, RoHS Directive 2011/65/EU		
Applied Standards	EN60730-1; EN60730-2-7; EN60730-2-9, EN 300 328		



Dispose of the device separately from household waste at an official collection point. Professional recycling protects people and the environment against potential negative effects.

WEEE Directive
2012/19/EU

Hereby, Schneider Electric Controls UK Ltd, declares that these products are in compliance with the essential requirements and other relevant provisions of RED 2014/53/EU. Declaration of Conformity can be downloaded from:
www.draytoncontrols.co.uk

Schneider Electric Controls
UK Ltd
401 Southway Drive
Plymouth
PL6 6QT
United Kingdom