



USER MANUAL

MODEL:

SWT3-31-HU-TR

3x1 4K60 USB-C/HDMI Switcher Extender

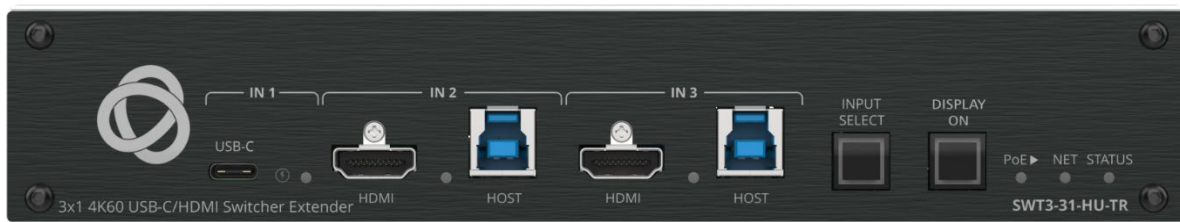

Contents

Introduction	1
Getting Started	1
Overview	2
Typical Applications	5
Defining SWT3-31-HU-TR 3x1 4K60 USB-C/HDMI Switcher Extender	6
Mounting SWT3-31-HU-TR	9
Connecting SWT3-31-HU-TR	10
Connecting the Output to a Balanced/Unbalanced Stereo Audio Acceptor	12
Connecting to SWT3-31-HU-TR via RS-232	12
Operating and Controlling SWT3-31-HU-TR	13
Principles of Operation	13
Using Front and Rear Panel Buttons	20
Operating via Ethernet	20
Using Embedded Web Pages	24
Routing Operations	27
Setting AV Properties	29
Setting Device Properties	32
Setting Control Gateway Properties	42
Viewing Device Status	58
Setting Security Properties	59
Viewing the About Page	63
Upgrading Firmware	64
Technical Specifications	65
Default Communication Parameters	66
Protocol 3000	67
Understanding Protocol 3000	67
Protocol 3000 Commands	68
Result and Error Codes	83

Introduction

Welcome to Kramer Electronics! Since 1981, Kramer Electronics has been providing a world of unique, creative, and affordable solutions to the vast range of problems that confront the video, audio, presentation, and broadcasting professional on a daily basis. In recent years, we have redesigned and upgraded most of our line, making the best even better!

Getting Started

We recommend that you:

- Unpack the equipment carefully and save the original box and packaging materials for possible future shipment.
- Review the contents of this user manual.



Go to www.kramerav.com/downloads/SWT3-31-HU-TR to check for up-to-date user manuals, application programs, and to check if firmware upgrades are available (where appropriate).

Achieving Best Performance

- Use only good quality connection cables (we recommend Kramer high-performance, high-resolution cables) to avoid interference, deterioration in signal quality due to poor matching, and elevated noise levels (often associated with low quality cables).
- Do not secure the cables in tight bundles or roll the slack into tight coils.
- Avoid interference from neighboring electrical appliances that may adversely influence signal quality.
- Position your Kramer **SWT3-31-HU-TR** away from moisture, excessive sunlight and dust.

Safety Instructions



Caution:

- This equipment is to be used only inside a building. It may only be connected to other equipment that is installed inside a building.
- For products with relay terminals and GPIO ports, please refer to the permitted rating for an external connection, located next to the terminal or in the User Manual.
- There are no operator serviceable parts inside the unit.



Warning:

- Use only the power cord that is supplied with the unit.
- To ensure continuous risk protection, replace fuses only according to the rating specified on the product label which is located on the bottom of the unit.

Recycling Kramer Products

The Waste Electrical and Electronic Equipment (WEEE) Directive 2002/96/EC aims to reduce the amount of WEEE sent for disposal to landfill or incineration by requiring it to be collected and recycled. To comply with the WEEE Directive, Kramer Electronics has made arrangements with the European Advanced Recycling Network (EARN) and will cover any costs of treatment, recycling and recovery of waste Kramer Electronics branded equipment on arrival at the EARN facility. For details of Kramer's recycling arrangements in your particular country go to our recycling pages at www.kramerav.com/il/quality/environment.

Overview

Congratulations on purchasing your Kramer **SWT3-31-HU-TR 3x1 4K60 USB-C/HDMI Switcher Extender**. **SWT3-31-HU-TR** is a high-performance auto-switcher with one USB-C and two HDMI/USB inputs, an HDMI output, and an extended-range HDBaseT 3.0 which may be flexibly set to transmit (output) or to receive (input). It supports extension up to 4K60Hz (4:4:4) HDMI, USB 2.0, Ethernet, RS-232, IR and power signals over twisted pair cable. The local and remote connected USB peripherals, such as a room camera and microphone, are switchable for use of the switcher active USB host, for convenient hybrid meeting operation with both room and online participants.

SWT3-31-HU-TR provides exceptional quality, advanced and user-friendly operation, and flexible control.

Exceptional Quality

- Hybrid-meeting Collaborative Switching – Controllable coupled-signals switching of both AV and USB host inputs, for concurrent connection with AV output and space USB devices, allows collaborative hybrid meeting where multiple meeting participants are switched to share their content with both room and online meeting participants.
- HDMI Signal Switching – HDCP 2.3 compliant, supporting deep color, x.v.Color™, CEC, HDMI uncompressed audio channels, Dolby TrueHD, DTS-HD, 2K, 4K, and 3D as specified in HDMI 2.0.
- Flexible USB Switching and Extension – An active USB 3.2 host is connected to the switcher extender on either the transmitter or receiver sides. USB 2.0 signals are extended between the switcher extender transmitter and receiver sides, enabling connection and switching of the active USB host to both local USB 3.2 and remote USB 2.0 devices, such as camera and audio devices, or HID (Human Interface Devices) mouse or keyboard devices.
- HDMI Mirroring – On switcher transmitter side, active USB-C or HDMI input signal is transmitted on the HDBT output, and in parallel mirrored to the HDMI output port for connecting a local monitor or adding an additional unit in a daisy chain.
- I-EDIDPro™ Kramer Intelligent EDID Processing™ – Intelligent EDID handling and processing that ensures Plug and Play operation.
- Multi-channel Audio Transmission – Up to 32 channels of digital stereo uncompressed signals for supporting studio-grade surround sound.

Advanced and User-friendly Operation

- **BYOD Ease and Convenience** – Connect any DP–Alt–Mode–capable USB–C device as an AV presentation source, while providing the connected device with USB 2.0 and Ethernet connection, and (if PD–2.0–capable) up to 60 watts of power, via a single USB–C cable connection only.
- **Auto Switcher Ease of Use** – Automatically plays signal of the plugged source on the connected display, according to user–configured preferences, such as last–connected input. Pair–synched kit–like auto–switching of paired kramer–recommended transmitter and receiver devices, for simple switching in control–less applications.
- **Display Power On/Off Control with Ease:** Simply press the DISPLAY ON button to toggle on / off the power of the connected CEC–enabled display. The button's LED indicator shows you whether the display is currently powered on / off.
- **Display On/Off Operation** – Meeting presentation is simplified by manually or automatically turning ON/OFF a CEC–enabled or serially–controlled display when the presentation source is plugged in / unplugged with user–defined shut–down delay.
- **Simple Control** – Remote IP–controller connection, browser operation webpage, local panel buttons, or remotely connected contact–closure buttons, for easy and fully flexible user ports selection, signals routing, and switcher control.
- **Comprehensive Management** – Local panel indication LEDs to facilitate easy local maintenance and troubleshooting. Remote IP–driven firmware upgrade and management via user–friendly embedded web pages and optional whole site management system, ensure lasting and field proven deployment.

Flexible Connectivity

- **High Performance Standard Extender** – Professional HDBaseT extender for providing extended–reach signals over twisted–pair copper infrastructures. SWT3–31–HU–TR is a standard extender that can be connected to any market–available HDBaseT–compliant extension product. For optimum extension reach and performance, use recommended Kramer cables.
- **Easy Online Meeting System Integrated Connectivity** – Built–in flexible auto–disconnection operation of USB devices, such as room cameras and soundbars, enable detection of BYOD presenter disconnection by online meeting systems for their auto–activation, convenient integration, and ease of end–user operation according to space changing hybrid session's needs.
- **Built-in Intelligent Control Gateway** - Remote IP–driven intelligent control of connected AV, USB and sensor devices via CEC, RS–232, IR or I/O. Eliminating the need for an external control gateway, this feature reduces installation complexity and costs, to enable easy integration with control systems, such as Kramer Control.
- **Secured Network Connection** – Standard IT–grade 802.1x authentication for secured IT LAN connectivity.
- **Audio De-embedding** – The digital audio signal passing–through to the output, is de–embedded, converted to an analog signal and sent to the stereo balanced analog audio output. This enables playing the audio on a locally connected professional audio system (such as DSP) and speakers, in parallel to playing it on the speakers connected to the AV acceptor

device (such as TVs with speakers).

- Ethernet Extension – Ethernet interface data flows in both directions, allowing extension of up to 1 Gbps Ethernet connectivity for LAN communication and device control.
- Bidirectional RS–232 Extension – Serial interface data flows in both directions, allowing data transmission and device control.
- Bidirectional Infrared Extension – IR interface data flows in both directions, allowing remote control of peripheral devices located at either end of the extended line.
- Secured Network Connection – Standard IT-grade 802.1x authentication for secured IT LAN connectivity.
- Easy and Elegant Installation – Flexible selectable PoE powering via LAN port or 2–way PoE powering via HDBT port connections, and 1U half–rack fan–less enclosure for under table, dropped–ceiling mounting, or side–by–side mounting of 2 units in a 1U rack space with the recommended rack adapter, for easy switcher deployment.

Typical Applications

SWT3-31-HU-TR is ideal for the following typical applications:

- Enterprise and education hybrid meeting rooms and classrooms.
- Hybrid user connection element in advanced hybrid meeting solutions.

Controlling your SWT3-31-HU-TR

Control your SWT3-31-HU-TR directly via the front panel push buttons, or:

- Via the IP commands transmitted by a controller and touch screen system, or a browser using built-in user-friendly Web pages.
- By RS-232 serial commands transmitted by a touch screen system, PC, or a serial controller.

Defining **SWT3-31-HU-TR 3x1 4K60 USB-C/HDMI Switcher Extender**



- Configuring the device as transmitter (Tx) or receiver (Rx, default) is done via the embedded webpages settings. (see [Setting Device Extension Operation Mode](#) on page 34).
- Set to receiver mode by default.

This section defines **SWT3-31-HU-TR**.

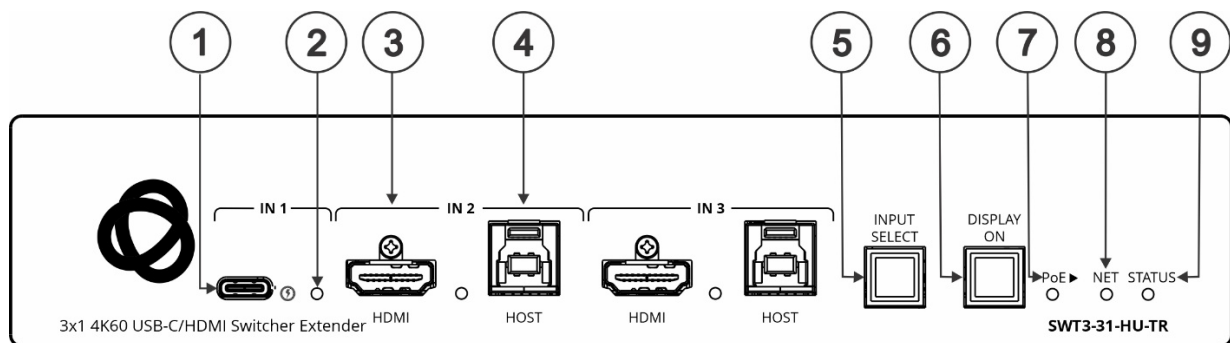

Figure 1: SWT3-31-HU-TR 3x1 4K60 USB-C/HDMI Switcher **Extender** Front Panel

#	Feature	Function										
1	USB-C IN 1 Port	Connect to USB-C AV sources: <ul style="list-style-type: none"> that support DisplayPort Alternate Mode, for example, a laptop) to share content. to communicate with the USB devices (for example, a PTZ camera) that are connected to the device, to connect to the LAN to charge the connected sources (that supports USB Power Delivery 2.0). ⓘ While charging, the charging icon (to the right of the connector) becomes visible and lights orange.										
2	IN Status LED 1 to 3 (per input port)	<table border="1"> <thead> <tr> <th>LED Status</th> <th>Indicates</th> </tr> </thead> <tbody> <tr> <td>Lights blue</td> <td>An input is selected and connected with an active AV or AV+USB source.</td> </tr> <tr> <td>Flashes blue</td> <td>An input is selected and has no active AV signal.</td> </tr> <tr> <td>Lights green</td> <td>An input is selected and connected with an active USB host only (no AV).</td> </tr> <tr> <td>Off</td> <td>An input is not selected and has an active AV signal.</td> </tr> </tbody> </table>	LED Status	Indicates	Lights blue	An input is selected and connected with an active AV or AV+USB source.	Flashes blue	An input is selected and has no active AV signal.	Lights green	An input is selected and connected with an active USB host only (no AV).	Off	An input is not selected and has an active AV signal.
LED Status	Indicates											
Lights blue	An input is selected and connected with an active AV or AV+USB source.											
Flashes blue	An input is selected and has no active AV signal.											
Lights green	An input is selected and connected with an active USB host only (no AV).											
Off	An input is not selected and has an active AV signal.											
3	IN Ports	HDMI										
4	(2 and 3)	HOST USB B 3.2 Connector										
3	HDMI	Connect to an HDMI source.										
4	HOST USB B 3.2 Connector	Connect to a USB host (for example, a room PC) to communicate with the USB devices (for example, a PTZ camera) connected on this device.										
5	INPUT SELECT Button	Press to select an input. Each press toggles to the next input. ⓘ 1-3 inputs for Tx mode, 1-4 inputs for Rx mode.										
6	DISPLAY ON Button	Press to turn display On/Off. Button LED lights on sending Display On message. Button LED turns off on sending Display Off message.										
7	PoE LED	Lights green when the device provides PoE to a connected device.										

#	Feature	Function	
8	NET LED	LED Status	Indicates
		Dark	No IP address acquired.
		Lights green	A valid IP address has been acquired.
		Flashes green for 60 seconds	A means to identify the device in a system, using command #IDV.
		LED Status	Indicates
9	STATUS LED	Dark	Power is off
		lights white	PoE powering is active.
		Lights blue	Power is on and a source is connected.
		Lights green	Power is on, and a source and an acceptor are connected.
		Dark	No IP address acquired.

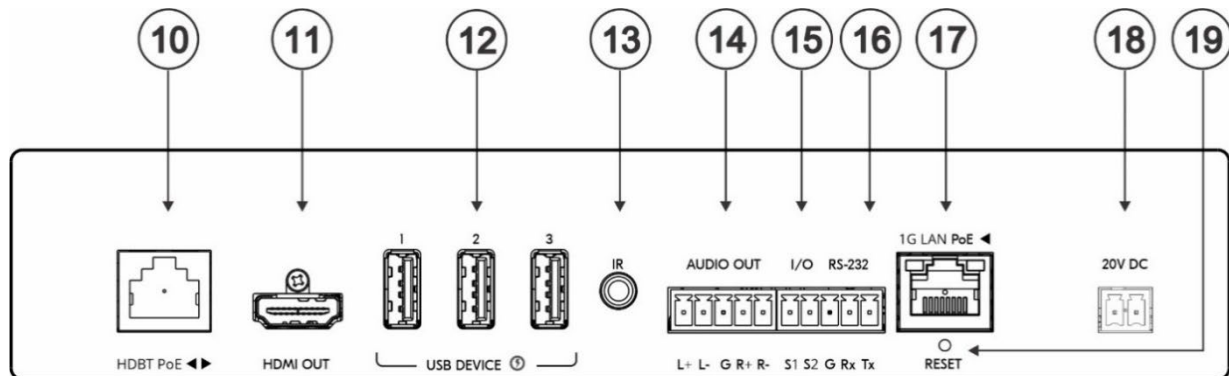

Figure 2: SWT3-31-HU-TR 3x1 4K60 USB-C/HDMI Switcher Extender Rear Panel

#	Feature	Function
10	HDBT PoE RJ-45 Connector	Connect to the HDBT RJ-45 connector to a paired receiver (when set to OUT on Tx mode) or transmitter (when set to IN on Rx mode) device that receives or provides PoE (for example, EXT3-21-XR-TR). i HDBT provides PoE only when the device is PSU-powered. HDBT is IN 4 on Rx mode.
11	HDMI OUT Connector	Tx Mode: Connect to a local HDMI acceptor (for example, a monitor). Rx Mode: Connect to an HDMI acceptor.
12	USB DEVICE Type A 3.2 Port (1 to 3)	Connect to the USB local devices (for example, a USB camera, a soundbar, microphone and so on).
13	IR 3.5mm Mini Jack	Connect to an IR emitter or sensor cable for IR extension over HDBT, or IR emitter for IR signal output per command from LAN-connected controller (for example, from KC-VB1).
14	AUDIO OUT 5-pin Terminal Block Connector	Connect to a balanced stereo analog audio acceptor.
15	I/O 3-pin Terminal Block (S1 to S2) (GND is common for I/O and RS-232).	Connect to: <ul style="list-style-type: none"> Input-triggering devices (for example, remote buttons or sensors), OR Output-triggered devices (for example, remote alarm LED indication). Each of these GPIO ports may be configured as a digital input, digital output, or an analog input port.
16	RS-232 3-pin Terminal Block	<ul style="list-style-type: none"> Connect and control the SWT3-31-HU-TR unit (default). Connect to an RS-232 controlled device (for example, the connected PTZ USB camera) to be controlled via an IP-connected controller (for example, SL-240C).
17	1G LAN PoE RJ-45 Connector	Connect to LAN. The device accepts power from the LAN port.
18	20V DC Power Connector	Use the included +20V 6A power supply for powering the unit and charging the source device connected to the USB-C port.

#	Feature	Function
19	RESET Recessed Button	For restoring factory default settings, press the RESET button and connect power to device (keep pressing longer than 6sec after power connection).

Mounting SWT3-31-HU-TR

This section provides instructions for mounting **SWT3-31-HU-TR**. Before installing, verify that the environment is within the recommended range:



- Operation temperature – 0° to 40°C (32 to 104°F).
- Storage temperature – -40° to +70°C (-40 to +158°F).
- Humidity – 10% to 90%, RHL non-condensing.



Caution:

- Mount **SWT3-31-HU-TR** before connecting any cables or power.



Warning:

- Ensure that the environment (e.g., maximum ambient temperature & air flow) is compatible for the device.
- Avoid uneven mechanical loading.
- Appropriate consideration of equipment nameplate ratings should be used for avoiding overloading of the circuits.
- Reliable earthing of rack-mounted equipment should be maintained.
- Maximum mounting height for the device is 2 meters.

Mount SWT3-31-HU-TR in a rack:

- Use the recommended rack adapter
(see www.kramerav.com/product/SWT3-31-HU-TR).

Mount SWT3-31-HU-TR on a surface using one of the following methods:

- Mount device with its recommended mounting accessory to the underside of the table and secure.
- Attach the rubber feet and place the unit on a flat surface.
- Mount the unit in a rack using the recommended rack adapter
www.kramerav.com/downloads/SWT3-31-HU-TR.

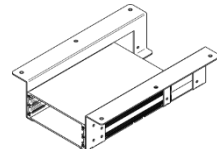

Connecting SWT3-31-HU-TR



- Switching between transmitter (Tx) and receiver (Rx) modes is done via the embedded webpages. (see [Setting Device Extension Operation Mode](#) on page 34).
- Set to receiver mode by default.

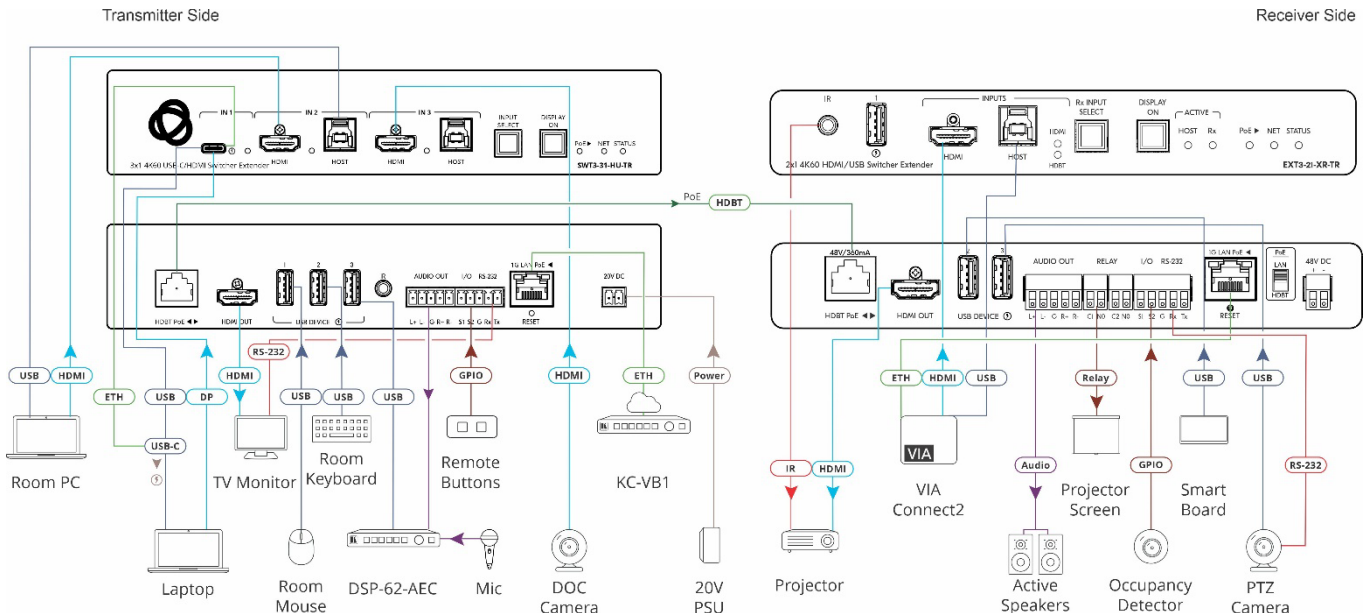

Figure 3: Connecting to the SWT3-31-HU-TR and paired receiver rear panels

To connect SWT3-31-HU-TR as illustrated in the example in [Figure 3](#):

1. Set the **SWT3-31-HU-TR** to Tx mode (see [Setting Device Extension Operation Mode](#) on page 34) and **EXT3-21-XR-TR** to Rx mode.
2. Connect the HDBT PoE port (10) on the transmitter to the HDBT PoE port on the **EXT3-21-XR-TR** receiver side.
3. On the **SWT3-31-HU-TR** side, connect:
 - A USB-C source (for example, a laptop that supports Display Port Alternate Mode) to the USB-C IN connector (1).
 - A source (for example, a room PC) to the IN 2 HDMI (3) and USB Host (4) connectors. Same for IN 3 (for example a DOC camera).
4. On the **EXT3-21-XR-TR** receiver, connect:
 - A source (for example, **VIA Connect2**) to the IN HDMI and USB Host connectors.
5. On the **SWT3-31-HU-TR** side, connect USB DEVICE ports:



USB devices that consume power greater than the power supplied by connected port (see Technical Specifications), should be powered by an external power supply.

- Connect the room mouse to the USB 1 port (12) on the rear panel.
- Connect the room keyboard to the USB 2 port (12) on the rear panel.
- Connect a sound system (for example Kramer **DSP-62-AEC**) to the USB 3 port (12) on the rear panel.

6. On the **EXT3-21-XR-TR** side, connect USB DEVICE ports:
 - Connect the smartboard to the USB 2 port on the rear panel.
 - Connect the PTZ camera to the USB 3 port on the rear panel.
7. On the **SWT3-31-HU-TR** side, connect the HDMI OUT port (11) to an HDMI acceptor (for example, a TV monitor).
8. On the **EXT3-21-XR-TR** side, connect the HDMI OUT port to an HDMI acceptor (for example, a projector).
9. On the **EXT3-21-XR-TR** side, to control the projector via IR, connect IR OUT 3.5mm mini jack to an IR emitter cable and attach the cable emitter side to the IR sensor of the touch projector.
10. On the **SWT3-31-HU-TR** side, to control the TV monitor, connect the RS-232 3-pin terminal block connector (16) to the TV monitor.
11. On the **EXT3-21-XR-TR** side, to control the PTZ camera, connect the RS-232 3-pin terminal block connector to the PTZ camera.
12. Connect a room controller (for example, the Kramer **KC-VB1**) via LAN to the LAN PoE Ethernet RJ-45 port (17).

Send from the room controller via LAN:

- IR commands via the room controller to control the Projector.
 - Serial commands to control the TV Monitor and PTZ camera.
13. On the **SWT3-31-HU-TR** side, connect the AUDIO OUT 5-pin terminal block connector (14) to a sound source (for example Kramer **DSP-62-AEC**).
 - Connect a Mic to a sound source (for example Kramer **DSP-62-AEC**).
 14. On the **EXT3-21-XR-TR** side, connect the AUDIO OUT 5-pin terminal block connector to a balanced stereo audio acceptor (for example, Kramer **Tavor 5-O** speakers).



The connected sound system (for example Kramer **DSP-62-AEC**) controls all aspects of sound, including output (speakers) and Input (microphone) peripherals.

15. On the **SWT3-31-HU-TR** side, connect the IO 2-pin terminal block (15):
 - To the Selector button.
16. On the **EXT3-21-XR-TR** side, connect the IO 2-pin terminal block:
 - To the Occupancy Detector.
17. On the **EXT3-21-XR-TR** side, connect the RELAY 2-pin terminal block:
 - To the Projector screen.



KC controls both devices and all connected controllable peripherals.

18. Connect LAN connector (17) to IT switch for LAN connection and optional PoE powering. Optionally, connect the power adapter to **SWT3-31-HU-TR** (18) and to the mains electricity.



To charge the device that is connected to the USB-C port, you need to connect the included power adapter (purchased separately) for powering the **SWT3-31-HU-TR** switcher.

Connecting the Output to a Balanced/Unbalanced Stereo Audio Acceptor

The following are the pinouts for connecting the output to a balanced or unbalanced stereo audio acceptor:

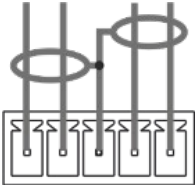

L+ L- G R+ R-

Figure 4: Connecting to a Balanced Stereo Audio Acceptor

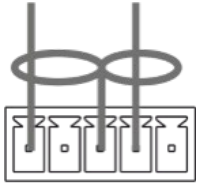

L+ L- G R+ R-

Figure 5: Connecting to an Unbalanced Stereo Audio Acceptor

Connecting to SWT3-31-HU-TR via RS-232

You can connect to **SWT3-31-HU-TR** via an RS-232 connection (13) using, for example, a PC.

SWT3-31-HU-TR features an RS-232 3-pin terminal block connector allowing the RS-232 to control **SWT3-31-HU-TR**.

Connect the RS-232 terminal block on the rear panel of **SWT3-31-HU-TR** to a PC/controller, as follows:

From the RS-232 9-pin D-sub serial port connect:

- Pin 2 to the TX pin on the **SWT3-31-HU-TR** RS-232 terminal block
- Pin 3 to the RX pin on the **SWT3-31-HU-TR** RS-232 terminal block
- Pin 5 to the G pin on the **SWT3-31-HU-TR** RS-232 terminal block

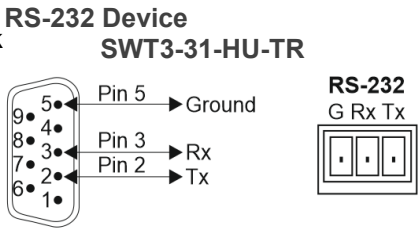

Operating and Controlling SWT3-31-HU-TR

Principles of Operation

This section covers the following topics:

- [Pair-synched Coupled AV+USB Auto Switching](#) on page [13](#).
- [Single Device Operates as Either Tx or Rx](#) on page [15](#).
- [Coupled or Individual AV+USB Switching](#) on page [16](#).
- [Local and Remote AV+USB Routing](#) on page [16](#).
- [Flexible SWT3-31-HU-TR Auto Switching Policy](#) on page [17](#).
- [Flexible USB-C Mix of Signals](#) on page [17](#).
- [Online Meeting Systems Integration](#) on page [17](#).
- [Routing IP-Driven Control Signals via Built-in Control Gateway](#) on page [18](#).
- [Flexible Remote Buttons Control](#) on page [19](#).
- [SWT3-31-HU-TR Flexible Powering](#) on page [19](#).

Pair-synched Coupled AV+USB Auto Switching

Two paired **SWT3-31-HU-TR** devices, one set as a transmitter (Tx mode) and the other set as a receiver (Rx mode), feature a default inter-synched pairing operation; No additional control system is needed to synch the pairing operation. This kit-like pair operation provides a cost-effective solution for standard rooms with flexible support for both Room-Based Meeting (RBM) or Bring Your Own Meeting (BYOM) hybrid meeting scenarios, as follows:

RBM scenario:

- Rx-connected room PC/NUC is running the room-based meeting app, such as Zoom Room.
- The room PC/NUC is auto-connected to all room USB devices, both the Tx-connected and Rx-connected USB devices.
- Room-located participants use the Tx-connected room USB devices for collaborating and sharing content via the room PC/NUC.

RBM

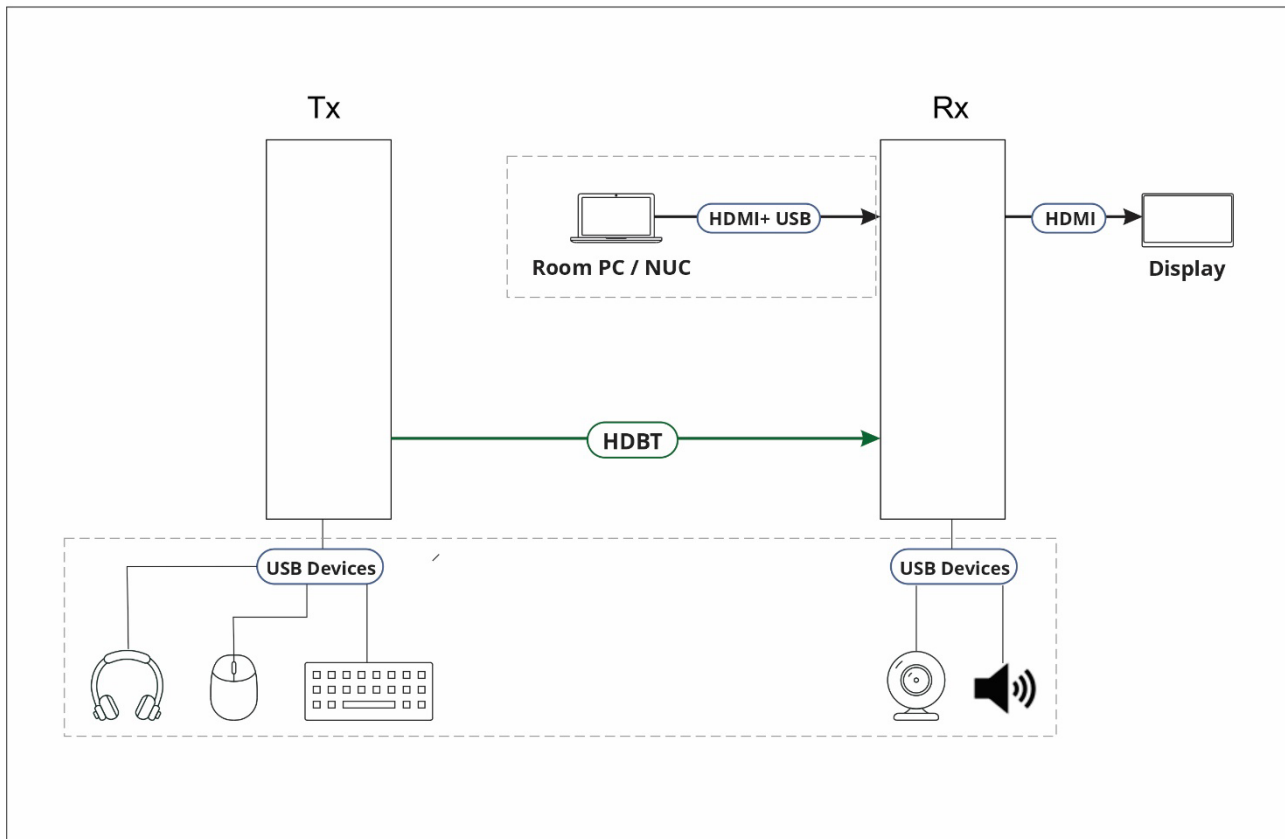

Figure 6: RBM Scenario

BYOM scenario:

- Room-located hybrid meeting participants bring their portable laptops running their own meeting app, such as Microsoft Teams.
- When the laptop connects to Tx, the laptop is auto-connected to all room USB devices, both the Tx-connected and Rx-connected USB devices.
- Room-located participants use the Tx-connected room USB devices for collaborating and sharing content via the laptop.

BYOM

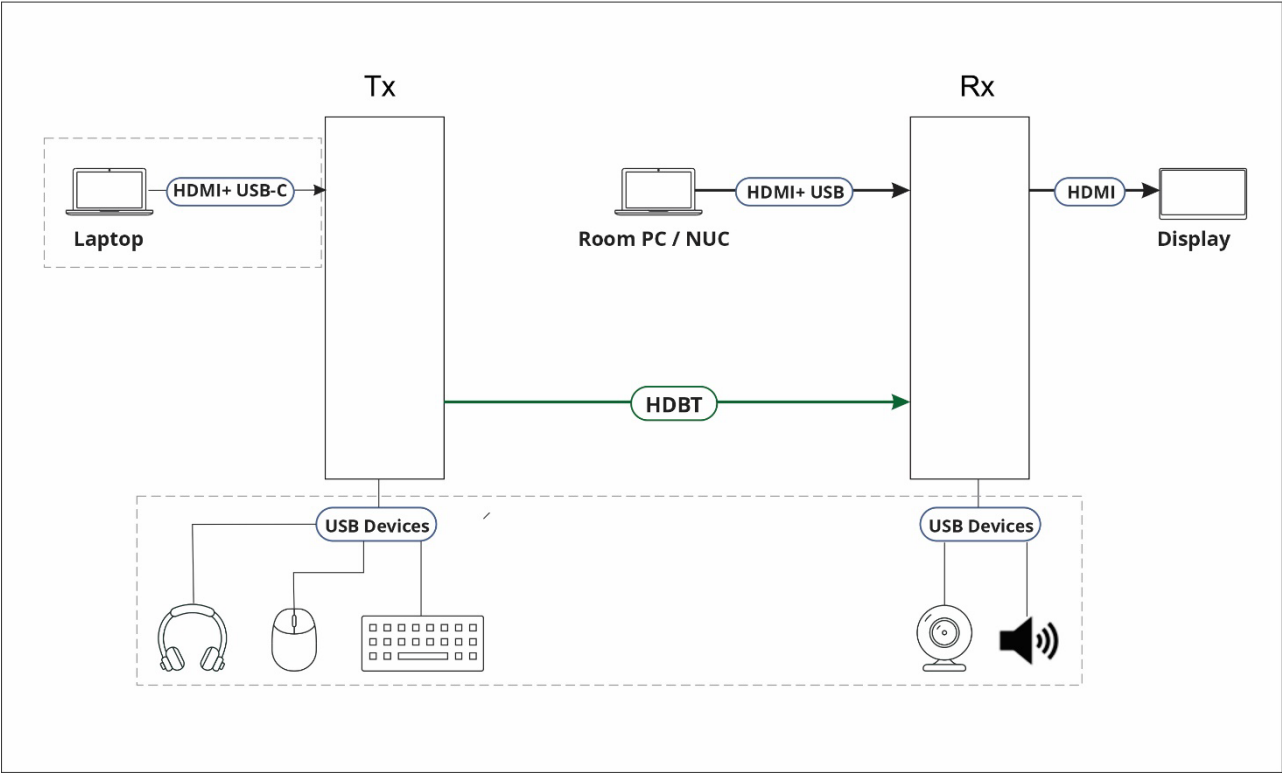

Figure 7: BYOM Scenario



Same synched pair operation applies also to mixed pairs of any Tx and Rx devices, providing that each device supports the pair-synched operation feature

Single Device Operates as Either Tx or Rx

Using the embedded webpage, the **SWT3-31-HU-TR** can be easily set to operate either as a transmitter (Tx) or receiver (Rx).

On Tx mode, switched AV signal is output on HDBT port and mirrored on HDMI output too.

On Rx mode, HDBT port AV and USB signals are switchable as 4th input and switched AV signal is output on HDMI output port.

See [Setting Device Extension Operation Mode](#) on page [34](#).

Coupled or Individual AV+USB Switching

SWT3-31-HU-TR multi-signal switching of any of the inputs to the AV output and connected (local and remote) USB devices, is configurable to use one of the following operation modes:

- USB follows AV coupled routing (↑↑) – Selecting an AV input, routes the AV signal to the AV output and connects, in parallel, the input-associated USB host with the connected USB devices.
- USB signal individual routing (↑) – Selecting an AV input, routes the AV signal to the AV output only. The USB host can be independently selected to connect with the connected USB devices (see Individual USB Host Routing).

See [Routing AV and USB Host Signals](#) on page 28.

This is very useful in hybrid sessions, for convenient switching between multiple presenters using either their BYOD laptops and/or connected room PC devices.

Local and Remote AV+USB Routing

When routing any of the inputs to the output, you can set all inputs to route the AV signal together with the USB signal (USB follows video coupled routing) or to independently route each individual signal.



- If the device is set to Tx mode, connect HDMI OUT connector to a local HDMI acceptor.
- If the device is set to Rx mode, connect HDMI OUT to an HDMI acceptor.

Routing cross-point grid for Tx and Rx operation modes (see [Routing an Input to an Output](#) on page 27), enable either coupled or independent AV and USB signals routing, as follows:

Extender Operation Mode	AV Routing	USB Host Routing
Tx	Inputs: 1xUSB-C + 2xHDMI	Input Hosts: 1xUSB-C + 2xUSB-B (local) + 1xHDBT (remote Rx) Routing between local and remote active USB Hosts.
	Outputs: 1xHDBT, Mirrored 1xHDMI	Output Devices: 3xUSB-A (local) + Rx USB devices (remote) USB local devices are always connected to active Host. Remote USB devices connection to local active Host is configurable.
Rx	Inputs: 1xUSB-C + 2xHDMI, 1xHDBT	Input Hosts: 1xUSB-C + 2xUSB-B (local) + 1xHDBT (remote Tx) Routing between local and remote active USB Hosts.
	Outputs: 1xHDMI	Output Devices: 3xUSB-A (local) + Tx USB devices (remote) USB local devices are always connected to active Host. Remote USB devices connections to local active Host is configurable.
Active Host connects to all local and remote devices.		

See [Routing an Input to an Output](#) on page 27.

Flexible SWT3-31-HU-TR Auto Switching Policy

Set the switching policy to:

- Manual – Select an input manually and switching occurs whether a live signal is present on the input or not.
- Auto – Auto Switching selection is performed according to either the Last Connected or the Priority policy.

In Last Connected policy:

- If a signal is plugged in this mode, **SWT3-31-HU-TR** will switch to it.
- If the signal on the current input is lost, **SWT3-31-HU-TR** automatically selects the last connected input.



The auto-switching delay depends on the configurable signal-lost timeout

In Priority policy:

- If a signal with a higher priority than the current one is plugged in this mode, **SWT3-31-HU-TR** will switch to it.
- When the input sync signal is lost for any reason, the input with a live signal and next in priority is selected automatically.



The auto-switching delay depends on the configurable signal-lost timeout. Inputs priority is configurable; the default Tx setting is USB C 1 → HDMI 2 → HDMI 3.



In both Last Connected and Priority modes, manually selecting an input (using the front panel, remote or web UI input select button) overrides automatic selection

See [Setting the Auto-Switching Policy](#) on page [29](#).

Flexible USB-C Mix of Signals

AV and USB signals mix, and their data rate level, of the USB-C host port, can be flexibly set to either one of:

- High USB 3.0 data rate and lower 4K60 4:2:0 AV resolution mix, or
- High 4K60 4:4:4 AV resolution and lower USB 2.0 data rate mix

See [Setting USB-C Host Port Signals Mix](#) on page [38](#).

Online Meeting Systems Integration

USB device ports can be set to auto-disconnect following presenter disconnection, to allow smooth integration and auto-activation of connected online meeting room systems.

See [Auto-disconnecting a USB Device on Inactive Host](#) on page [39](#).

Routing IP-Driven Control Signals via Built-in Control Gateway

Remote IP connected clients can send from the LAN, via the **SWT3-31-HU-TR** built-in control gateway, CEC, RS-232, I/O and IR commands, and receive responses and notifications, to control devices connected to **SWT3-31-HU-TR** HDMI-CEC, RS-232, I/O and IR control ports. The built-in control gateway sends the control commands (converted from the client received IP messages) to the connected controlled devices, and distributes the responses received from the connected controlled devices to all connected clients.

[Figure 3](#) shows the **SWT3-31-HU-TR** and its paired receiver built-in control gateways connections. The Kramer Control controller is connected to the switcher transmitter via LAN, sends IP commands to the switcher transmitter and paired receiver control gateways over the LAN connection, to send control messages to, and receive control responses from:

- The TV monitor connected to the switcher transmitter via the RS-232 and/or HDMI (CEC) ports.
- The PTZ Camera connected to the receiver via the RS-232 port.
- The VIA connected to the receiver via the HDBT-extended LAN connection and receiver LAN port.
- The Projector connected to the receiver via the IR port, and its screen via the Relay port.
- The Occupancy Detector & Select In Button connected to the receiver via the I/O ports.

Built-in control gateway activation, activation of the associated control ports and their attributes (such as the CEC logical address of the control gateway), as well as manual commands testing operation, is done via SWT3-31-HU control gateway webpages (see [Setting Control Gateway Properties](#) on page [42](#)).

Flexible Remote Buttons Control

Remote contact-closure buttons can be connected to the I/O ports, for easy end user control of device functions by button press and release operation. Flexible configuration of button press/release actions and latching (default) or momentary operation mode, enable simple and custom control according to user needs.

(see [Configuring Remote Buttons](#) on page [53](#)).

SWT3-31-HU-TR Flexible Powering

The **SWT3-31-HU-TR**, when connected to the power supply, can supply power to the connected transmitter / receiver via HDBT and charge the USB-C-connected source. The **SWT3-31-HU-TR**, can also accept power from either LAN or HDBT.

Using Front and Rear Panel Buttons

SWT3-31-HU-TR front and rear panel buttons enable the following actions:

- Selecting an INPUT.
- Turning the remote display on or off via the DISPLAY ON or sending on or off commands that are configured via the UI (see [Defining and Testing Commands via Action Editor](#) on page 52) .
- Resetting device to its factory settings (for additional instructions on resetting and resetting device (see [Resetting and Restarting Device](#) on page 35).

Operating via Ethernet

You can connect to SWT3-31-HU-TR via Ethernet using either of the following methods:

- Directly to the PC using a crossover cable (see [Connecting Ethernet Port Directly to a PC](#) on page 20).
- Via a network switch or router, using a straight-through cable (see [Connecting Ethernet Port via a Network Switch](#) on page 22).



If you want to connect via a router and your IT system is based on IPv6, speak to your IT department for specific installation instructions.

Connecting Ethernet Port Directly to a PC

You can connect the Ethernet port of SWT3-31-HU-TR directly to the Ethernet port on your PC using a crossover cable with RJ-45 connectors.



This type of connection is recommended for identifying SWT3-31-HU-TR with the factory configured default IP address.

After connecting SWT3-31-HU-TR to the Ethernet port, configure your PC as follows:

1. Click **Start > Control Panel > Network and Sharing Center**.
2. Click **Change Adapter Settings**.

- Highlight the network adapter you want to use to connect to the device and click **Change settings of this connection**.

The Local Area Connection Properties window for the selected network adapter appears as shown in [Figure 8](#).

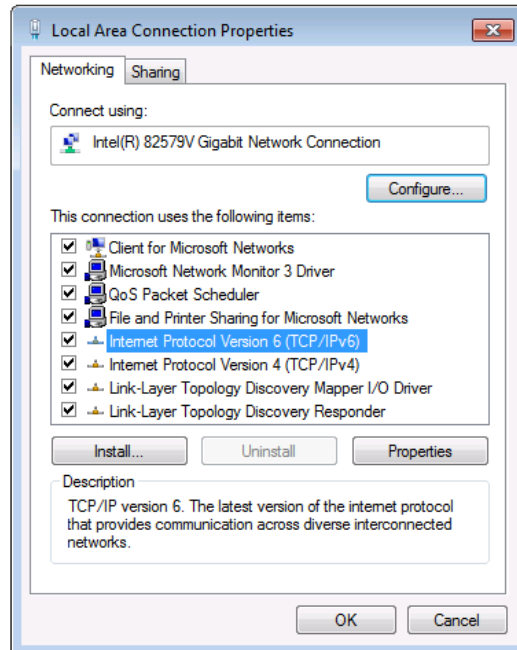

Figure 8: Local Area Connection Properties Window

- Highlight either **Internet Protocol Version 6 (TCP/IPv6)** or **Internet Protocol Version 4 (TCP/IPv4)** depending on the requirements of your IT system.
- Click **Properties**.

The Internet Protocol Properties window relevant to your IT system appears as shown in [Figure 9](#) or [Figure 10](#).

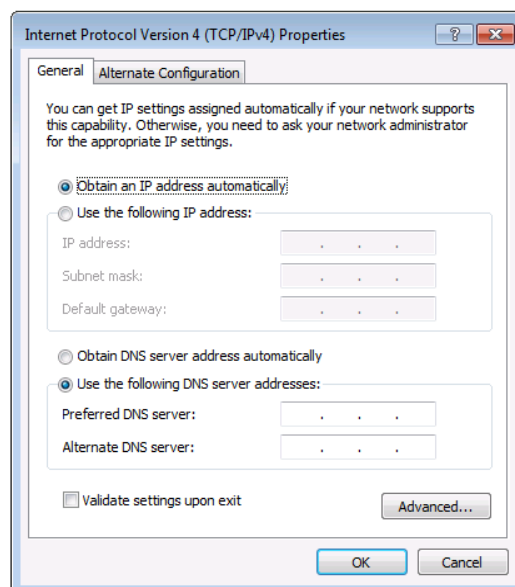

Figure 9: Internet Protocol Version 4 Properties Window

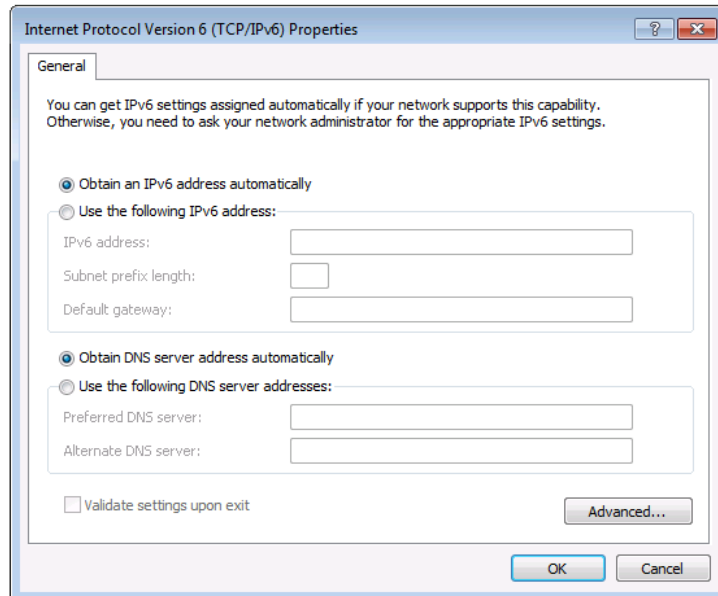

Figure 10: Internet Protocol Version 6 Properties Window

6. Select **Use the following IP Address** for static IP addressing and fill in the details as shown in [Figure 11](#).

For TCP/IPv4 you can use any IP address in the range 192.168.1.1 to 192.168.1.255 (excluding default 192.168.1.39 fallback address) that is provided by your IT department.

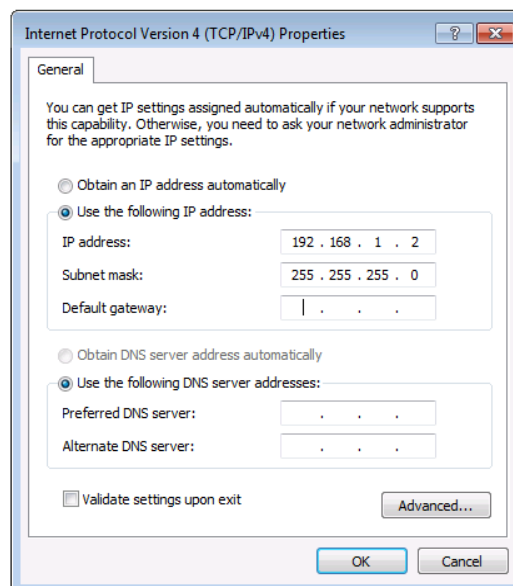

Figure 11: Internet Protocol Properties Window

7. Click **OK**.
8. Click **Close**.

Connecting Ethernet Port via a Network Switch

You can connect the Ethernet port of **SWT3-31-HU-TR** to the Ethernet port on a network switch or router using a straight-through cable with RJ-45 connectors.

Configuring Ethernet Port

You can set the Ethernet parameters via the embedded Web pages.

Discovering and acquiring IP address

SWT3-31-HU-TR includes IP address auto-acquiring policy via LAN-connected DHCP server by default. When no DHCP server is detected, a fallback static IP address of 192.168.1.39, and 255.255.255.0 subnet mask (class C), is assigned until an IP address is acquired via the DHCP server.

For more information, refer to Product Page Technical Note in www.kramerav.com/product/SWT3-31-HU-TR.

Using Embedded Web Pages

SWT3-31-HU-TR enables you to configure settings via Ethernet using built-in, user-friendly web pages. The Web pages are accessed using a Web browser and an Ethernet connection.

 You can also configure **SWT3-31-HU-TR** via Protocol 3000 commands (see [Protocol 3000 Commands](#) on page 68).

Before attempting to connect:

- Perform the procedure in (see [Operating via Ethernet](#) on page 20).
- Ensure that your browser is supported.

The following operating systems and Web browsers are supported:

Operating Systems	Browser
Windows 10 and higher	Edge
	Chrome
Mac	Safari
iOS	Safari
Android	N/A

 If a web page does not update correctly, clear your Web browser's cache.

 Check that Security/firewalls are not blocking HTTP traffic between the device and the user PC.

To access the web pages:

1. Enter the IP address of the device in the address bar of your internet browser (default = 192.168.1.39).

If security is enabled, the Login window appears.

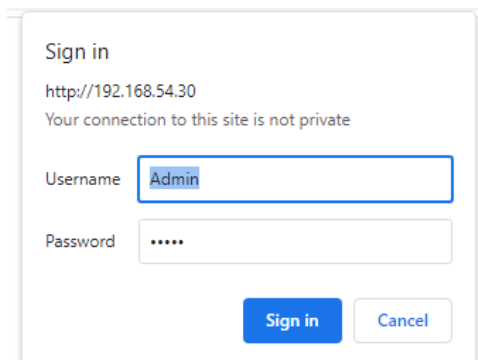

Figure 12: Embedded Web Pages Login Window

- 2. Enter the Username (default = Admin) and Password (default = Admin) and click **Sign in**. The default web page appears.

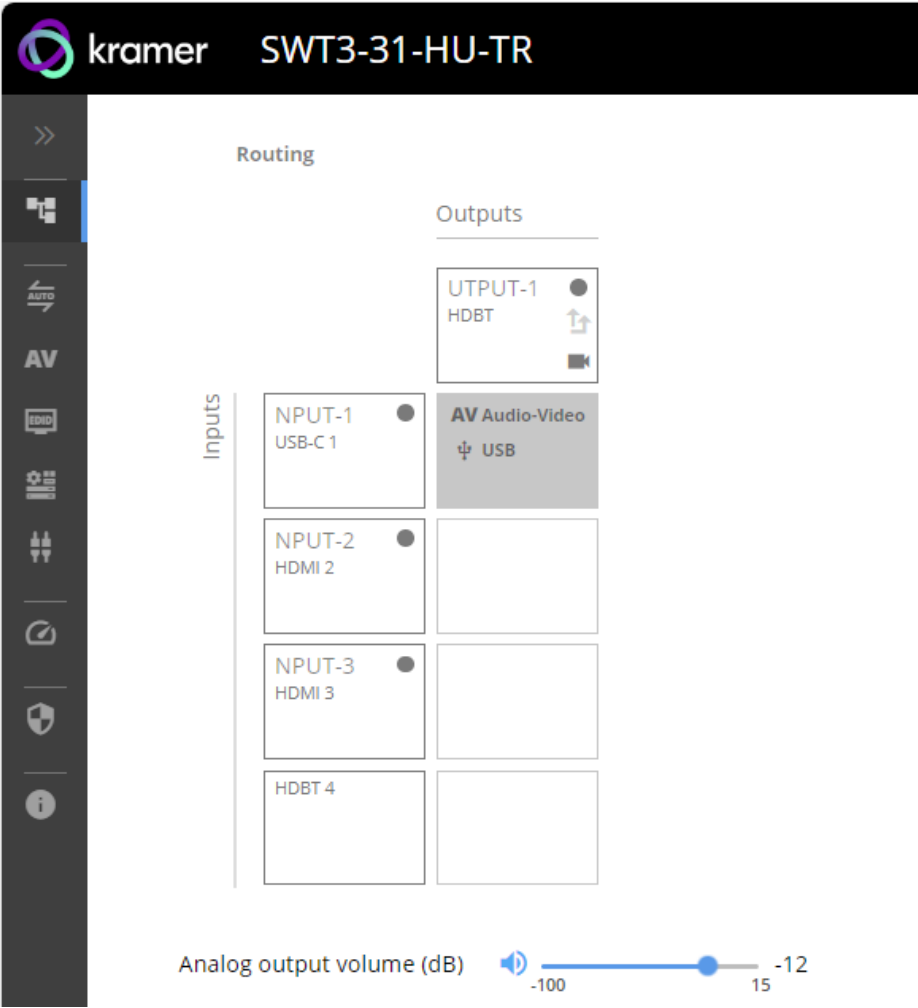

Figure 13: AV Settings Page

- Click the arrow at the top of the navigation list to view the menu items in detail.

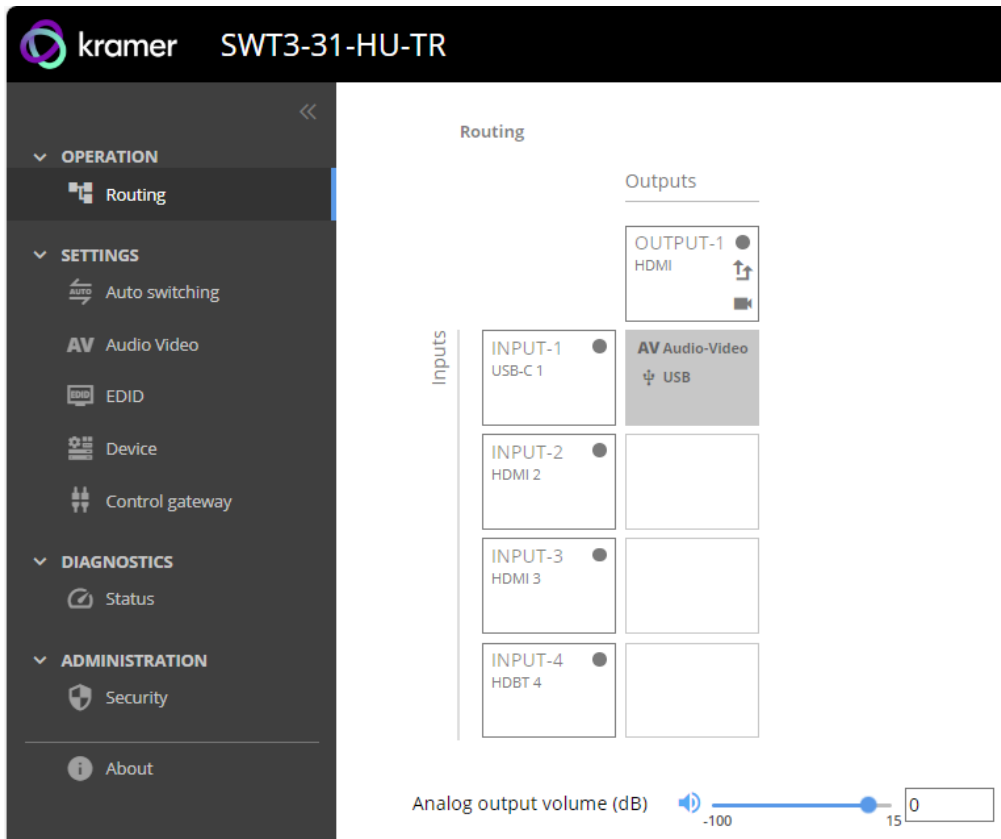

Figure 14: Navigation pane in Detail

- Click the Navigation Pane on the left side of the screen to access the relevant web page.



Using the embedded webpage, the **SWT3-31-HU-TR** can be easily set to operate either as a transmitter (Tx) mode or receiver (Rx) mode. See [Setting Device Extension Operation Mode](#) on page [34](#).



- When **SWT3-31-HU-TR** is set to Rx mode, there are X4 inputs and outputs to select from.
- When **SWT3-31-HU-TR** is set to Tx mode, there are X3 inputs and outputs to select from.

SWT3-31-HU-TR web pages enable performing the following actions:

- [Routing Operations](#) on page [27](#).
- [Setting AV Properties](#) on page [29](#).
- [Setting Device Properties](#) on page [32](#).
- [Setting Control Gateway Properties](#) on page [42](#).
- [Viewing Device Status](#) on page [58](#).
- [Setting Security Properties](#) on page [59](#).
- [Viewing the About Page](#) on page [63](#).

Routing Operations

This section details the following actions:

- [Routing an Input to an Output](#) on page 27.
- [Setting Analog Audio Output Level](#) on page 28.

Routing an Input to an Output

Route any of the inputs to the output. Set all inputs to route the AV signal together with the USB signal (USB follows video coupled routing) or to independently route each individual signal.

For further detail, see [Local and Remote AV+USB Routing](#) on page 16.

To route the video inputs to the outputs:

1. Go to the Routing Settings page.

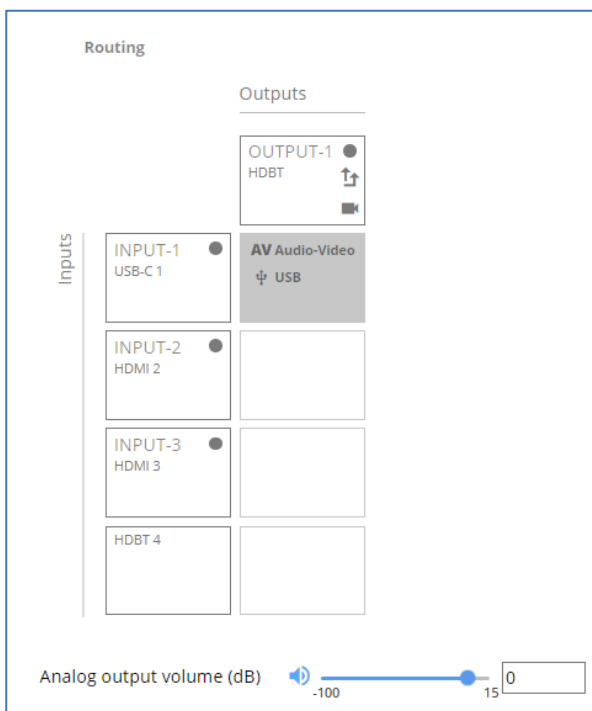

Figure 15: Tx Mode Routing Page

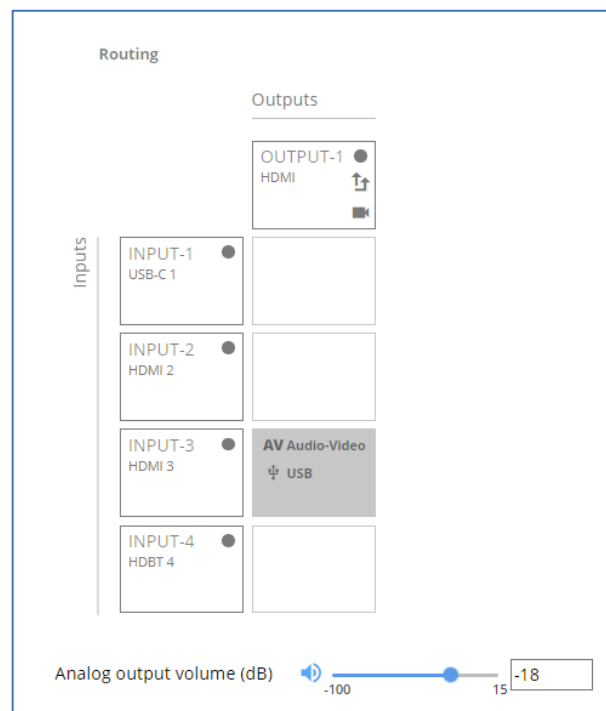



Figure 16: Rx Mode Routing Page

2. Perform the following functions:

- Click an Input/Output cross-point (see [Routing AV and USB Host](#) Signals on page 28).



A green light on a button indicates a connected source/acceptor.

- Click  to activate USB following video coupled routing.
- Click  to stop/play the video.

An input is routed to the output.

Routing AV and USB Host Signals

SWT3-31-HU-TR enables switching any of the inputs to the output in one of the following operation modes:

- USB follows AV coupled routing (↑↑) – Selecting an input, routes the HDMI signal to the output and associates the USB devices to that selected USB host.
- USB signal individual routing (↑ψ) – Selecting an input, routes the HDMI signal to the output. The USB host can be selected separately from any of the other inputs.

Individual USB Host Routing

In the following example, USB routing does not follow video, so you can individually select the AV signal on input 3 and the USB signal on input 1. This means that the HDMI input 3 AV signal is routed to the output and the USB devices are associated with the USB-C host (Input 1).

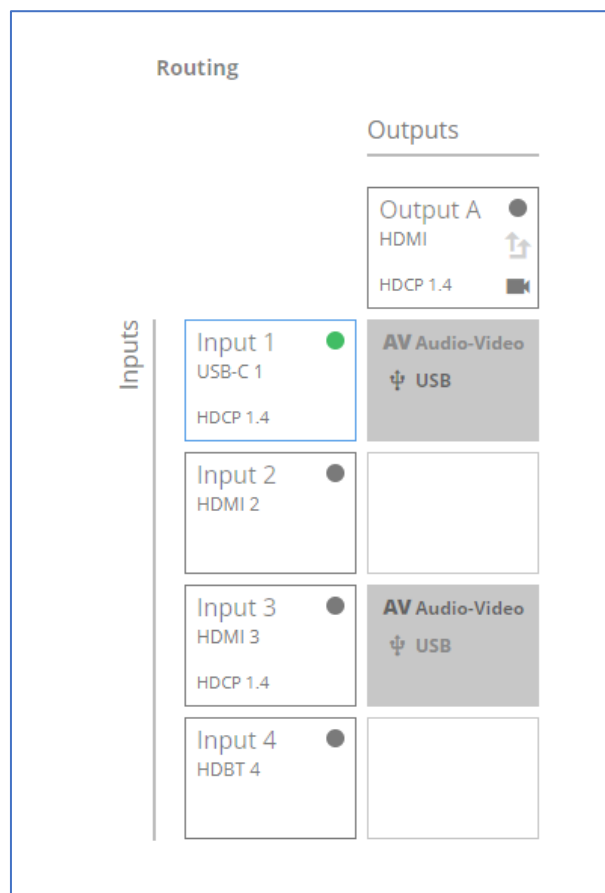

Figure 17: Individual routing of USB Host and AV Signal

Setting Analog Audio Output Level

To set the audio output level:

1. Go to the Routing Settings page.
2. Next to Analog output volume (dB) click 🔊 .
3. Set the audio volume level:
 - using the slider next to Analog output volume (dB, from -80 to 20), or

- enter the audio output volume in the text box.

Audio level is set.

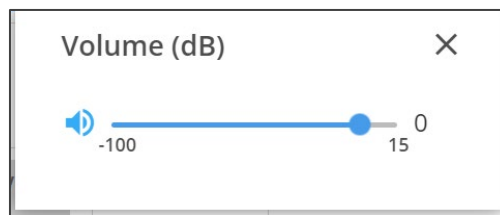

Figure 18: Setting Audio Output Level

Video inputs are routed to the outputs.

Setting AV Properties

This section details the following actions:

- [Setting the Auto-Switching Policy](#) on page [29](#).
- [Configuring AV Settings](#) on page [31](#).
- [Managing EDID](#) on page [32](#).

Setting the Auto-Switching Policy

To set the auto-switching policy:

1. Go to the Auto switching page.
2. Next to the Selection Mode drop-down box, select the auto switching policy: **Manual**, **Last Connected** or **Priority**.

Switching policy is set.

To change input priorities:



For Rx mode, HDBT should be IN 4.

1. Go to the Auto switching page.
2. Next to the Selection Mode drop-down box, select **Priority**.

3. Click and drag an input between high and low to change the priorities.

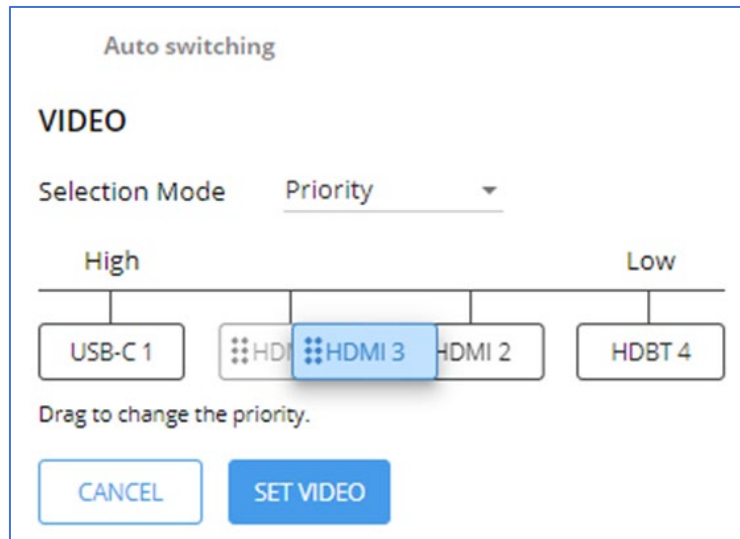

Figure 19: Changing Input Priorities

4. Click **SET VIDEO**.

Input priorities are set.

Settings AV Signal Properties

SWT3-31-HU-TR enables setting the audio and video signal properties.



AV properties related to CEC signals are not configurable. They are passing through:

- Tx mode: Between active HDMI input and HDBT output.
- Rx mode: Between active HDMI or HDBT input and HDMI output.

Configuring AV Settings

SWT3-31-HU-TR enables configuring the device audio and video settings.

To configure audio and video settings:

1. Go to the Audio Video Settings page. The Audio Video Settings page appears.

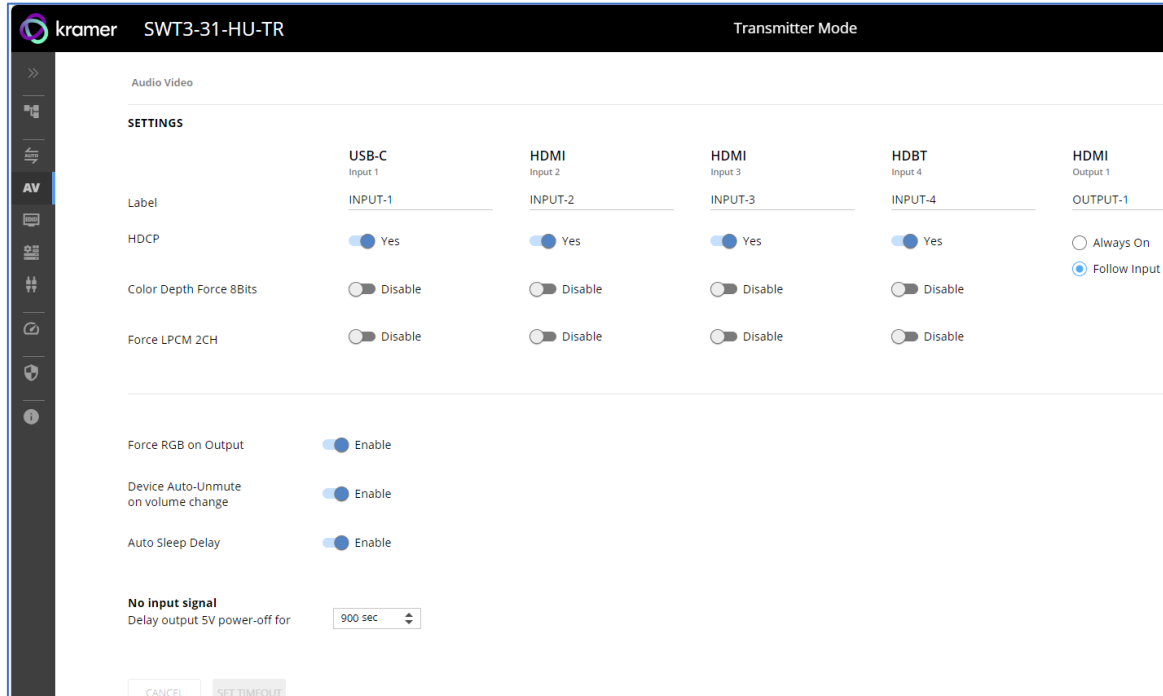

Figure 20: Audio Video Settings

2. Perform the following actions:

- Label – Change the name of an input or the output as it appears on the Routing page and EDID management page.
- HDCP – For the inputs, select the **Yes** (default) /**No** switch to enable/disable HDCP for that input. For the output, select **Always On** keep HDCP enabled or **Follow Input** (default) to define the output HDCP setting according to the active input.
- Color Depth Force 8Bits – **Enable** or **Disable** (default) on each input.
- Force LPCM 2CH – **Enable** or **Disable** (default) on each input.
- Force RGB on Output – **Enable** or **Disable** (default).
- Device Auto-Unmute on volume change – When enabled changing the volume will auto-unmute the audio output.
- Auto Sleep Delay – When no input signal is detected, the display automatically goes into sleep mode, and output is set to off. When this setting is enabled (default), it delays sleep mode for an amount of time specified in the next setting.
- No input signal (active when Auto Sleep Delay is enabled) – Set the number of seconds (15 to 60,000 seconds; default = 900 seconds) after there is no signal detected, until the display goes into sleep mode. Click **SET TIMEOUT** after defining this setting.

Audio and video settings are configured.

Managing EDID

SWT3-31-HU-TR enables you to copy an EDID from one of several different sources to the inputs.

To copy the EDID to the inputs:

1. Go to the EDID Management page.

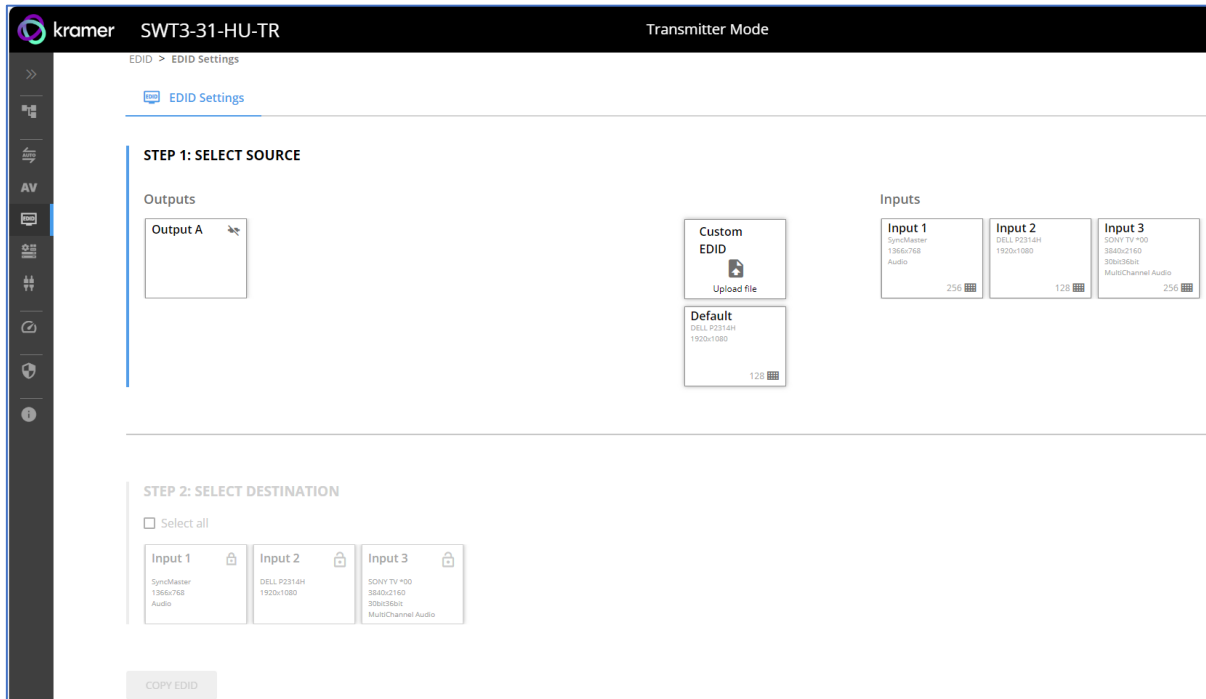

Figure 21: EDID Management Page

2. Under Step 1, select the EDID source (the output, any of the inputs, default or custom EDID).
3. Under Step 2, select one or more inputs as the destination for copying the EDID.
4. Click **COPY EDID**.

The EDID is copied.

Setting Device Properties

This section details the following actions:

- [Device Profile and Maintenance](#) on page [32](#).
- [Settings Networking Properties](#) on page [37](#).
- [Setting Time and Date](#) on page [41](#).

Device Profile and Maintenance

Changing Device Name

SWT3-31-HU-TR enables you to change the DNS name of the device.

To change the device name:

1. Go to the Device > General page.

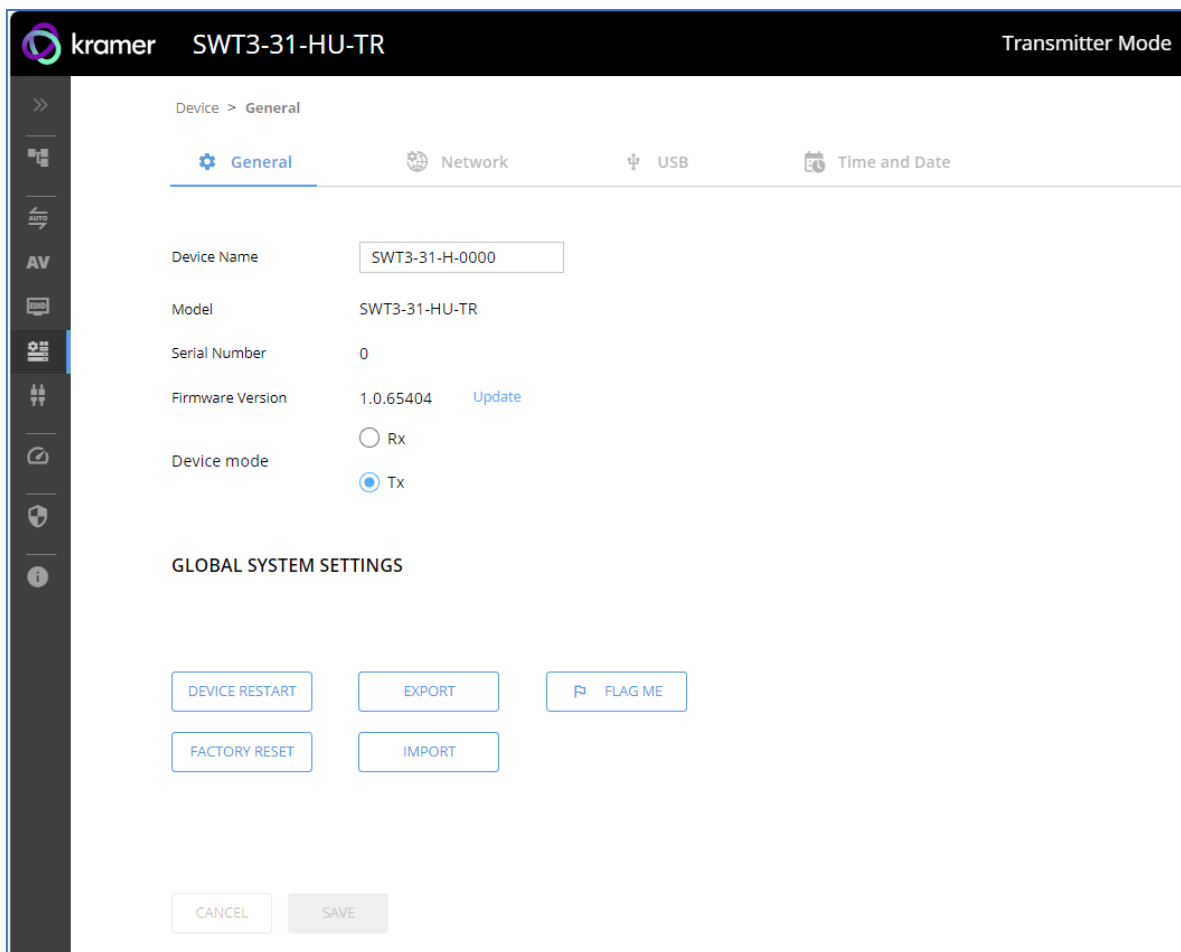

Figure 22: Device > General Page

2. Under General Preferences, change the device name and click **SAVE**.

The device name is changed.

Setting Device Extension Operation Mode



This section applies to both Tx (transmitter) and Rx (receiver) modes unless otherwise noted.

To switch between Tx or Rx modes

1. Go to the Device>General tab.
2. Select either Rx or Tx.

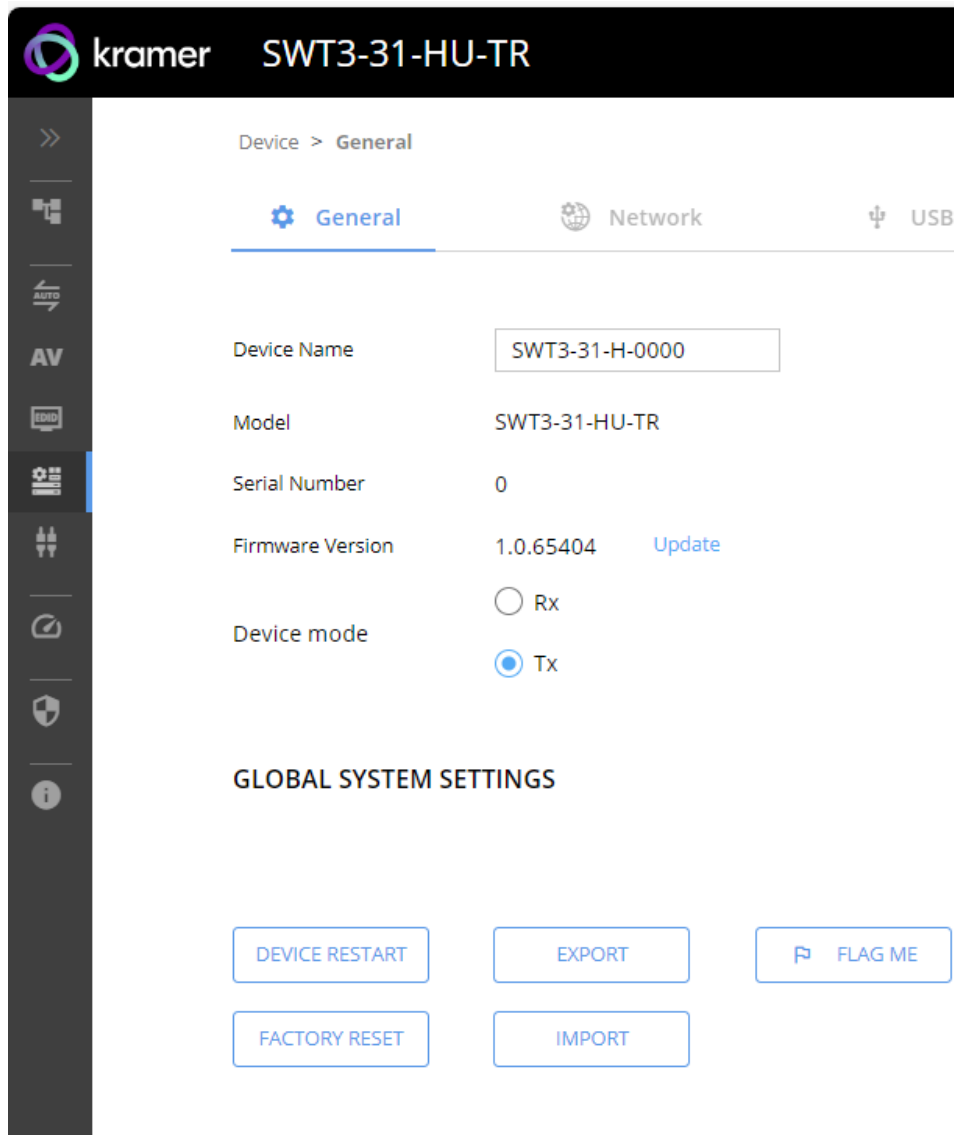

Figure 23: Device Tab: Switching Rx / Tx Operation Mode

3. Click **Save**. A device Reset message appears.

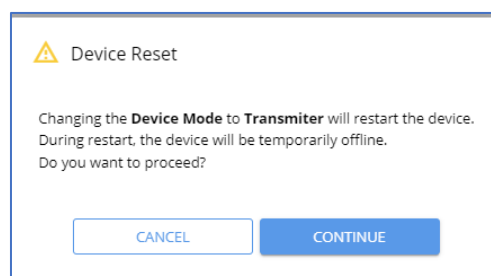

Figure 24: Device Reset Warning Message

4. Click CONTINUE. The device is switching extension operation modes.



This can take up to 60 seconds.

5. The device extension device mode indication, at the top bar, shows the newly selected extension mode.

Upgrading Firmware

To upgrade the device firmware:

1. Go to the **Device > General** page ([Figure 22](#)).
2. Under General, click **Update**, open the relevant firmware file, and follow the instructions. The upgrade takes approximately 30-60 seconds.



- During FW upgrade, the device continues to operate, but the device UI and protocol 3000 communication are inactive. When device restarts, the status LED is lit, and HDMI output signal is disconnected until restart completes.

Firmware is updated.

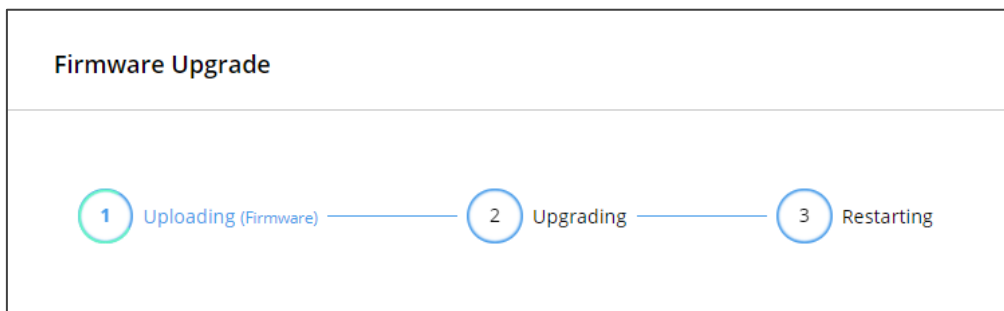

Figure 25:Firmware Upgrade Process

Resetting and Restarting Device

Two types of resets can be performed:

- Restart – Reboots your device and keeps all your device settings, including the IP address and password.
- Reset – Reboots your device and restores all factory settings including input/output definitions, switching configuration, IP address and password (a DHCP-acquired IP address is retained).

To restart the device:

- Click **DEVICE RESTART** on the **Device > General** page ([Figure 22](#)).

To perform a factory reset on the device, use one of the following actions:

- Click **FACTORY RESET** on the **Device > General** page ([Figure 22](#)).
- Using protocol 3000 commands, send FACTORY command then RESET commands.
- On the rear panel, press and hold the RESET button while connecting the power for several seconds.

Exporting and Importing a Configuration File

SWT3-31-HU-TR enables you to export and store (in connected browsing PC storage) a configuration file, that records all current device settings except the routing operation setup. The stored file can then be imported to the same or different **SWT3-31-HU-TR** device to load the recorded settings, for configuration backup and/or solution-replication purposes.

Exporting a Configuration File

To export a configuration file of the current device settings:

1. Go to the **Device > General** page ([Figure 22](#)).
2. Under Global System Settings, click **EXPORT**.
3. Select the storage location on your computer to save the configuration file and click **SAVE**.

The configuration file is exported and saved.

Importing a Configuration File

To import a configuration file of the current device settings:

1. Go to the **Device > General** page ([Figure 22](#)).
2. Under Global System Settings, click **IMPORT**.
3. Select the relevant configuration file from your computer storage and click **SAVE**.

The configuration file is imported and the device restarts with the settings from the configuration file.

Identifying Your Device

To identify the device:

1. Go to the **Device > General** page ([Figure 22](#)).
2. Under Global System Settings, click **FLAG ME**. NET LED flashes.



FLAG ME indication turns off after 60 seconds.

Settings Networking Properties



By default, DHCP is set to on. The IP address shows the actual IP address acquired from the DHCP server, or the auto-acquired fallback IP address when there is no DHCP server detection.

To configure network settings:

1. Go to the **Device > General** page ([Figure 22](#)).
2. Select the **Network** tab.

The network page appears.

Setting	DHCP On	DHCP Off
DHCP	On	Off
MAC Address	00-1d-56-0a-a5-aa	00-1d-56-0a-a5-aa
IP Address	192.168.1.39	192.168.1.39
Mask Address	255.255.0.0	255.255.0.0
Gateway Address	192.168.0.254	192.168.0.254

Figure 26: Device Settings > Network Page (DHCP On/DHCP Off)

3. Change settings as needed.

If required, Set to **DHCP** (default) or static IP address resolution modes.

4. When in Static IP mode, perform the following actions:
 - Change the IP address.
 - Change the Mask address.
 - Change the Gateway address.

Network settings are defined.

Setting USB-C/B Host Port Signals Mix

AV and USB combined signals mix, and their data rate levels, of the USB-C/B host port, can be flexibly set.



In order to apply the USB-C type change, you must perform power cycle.



USB-C/B ethernet connection is disabled by default and is enabled only by command. (see [Protocol 3000 Commands](#) on page 68) .

To select USB-C/B host port signals mix:

1. Go to the **Device > General** page ([Figure 22](#)).
2. Select the USB tab.

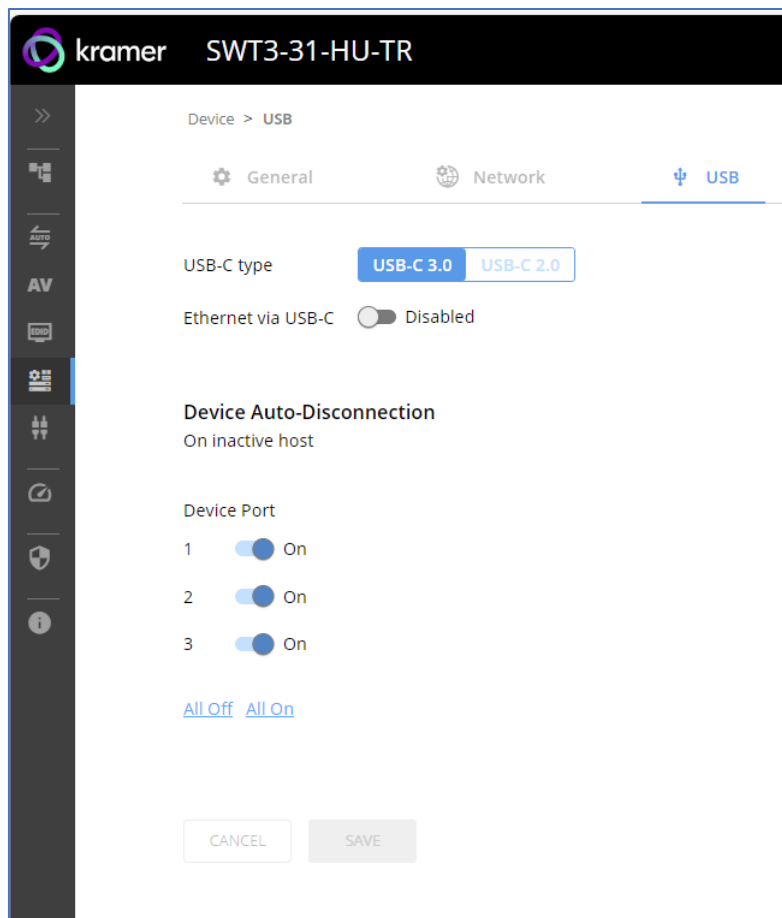

Figure 27: Figure 28: USB Page – USB-C/B Host Port Data Range Level Selection

3. Next to USB-C/B type, select one of the following:
 - **USB-C 3.0** - High USB 10Gbps data rate and lower 4K60 4:2:0 AV resolution mix.
 - **USB-C 2.0** - High 4K60 4:4:4 AV resolution and lower USB 480Mbps data rate mix.
4. Click **SAVE**.

USB-C/B host signals mix is set.

Enabling/Disabling Ethernet Connection via USB-C

You can enable (disabled by default) the ethernet connection.

To enable the ethernet connection:

1. Go to the **Device > General** page ([Figure 22](#)).
2. Select the USB tab.

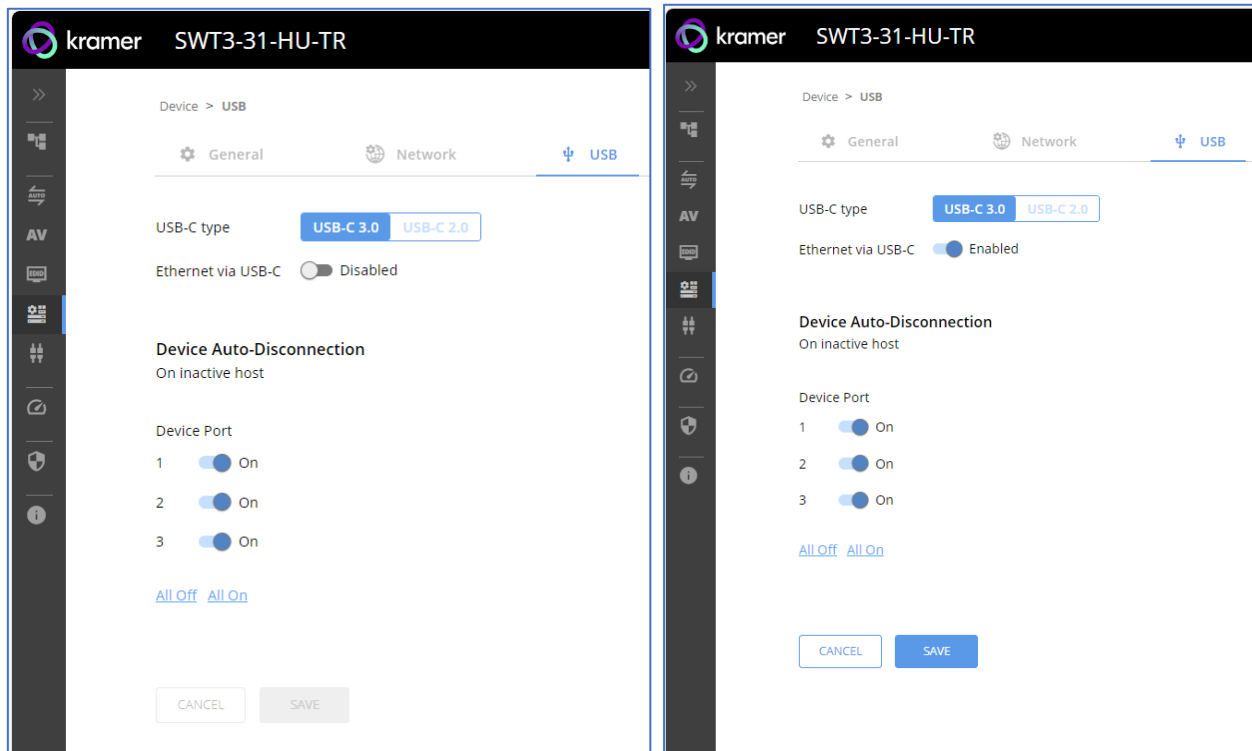

Figure 29: USB Page – USB-C Disabled/Enabled via USB-C

3. Next to **Ethernet via USB-C**, click:
 - **Enabled** to enable ethernet connection via USB-C
 3. Click **SAVE**.
- Ethernet via USB-C is enabled.

Auto-disconnecting a USB Device on Inactive Host

When a host becomes inactive, you can automatically disconnect one or multiple USB devices.

To define auto-disconnection:

1. Go to the **Device > General** page ([Figure 22](#)).
2. Select the USB tab.

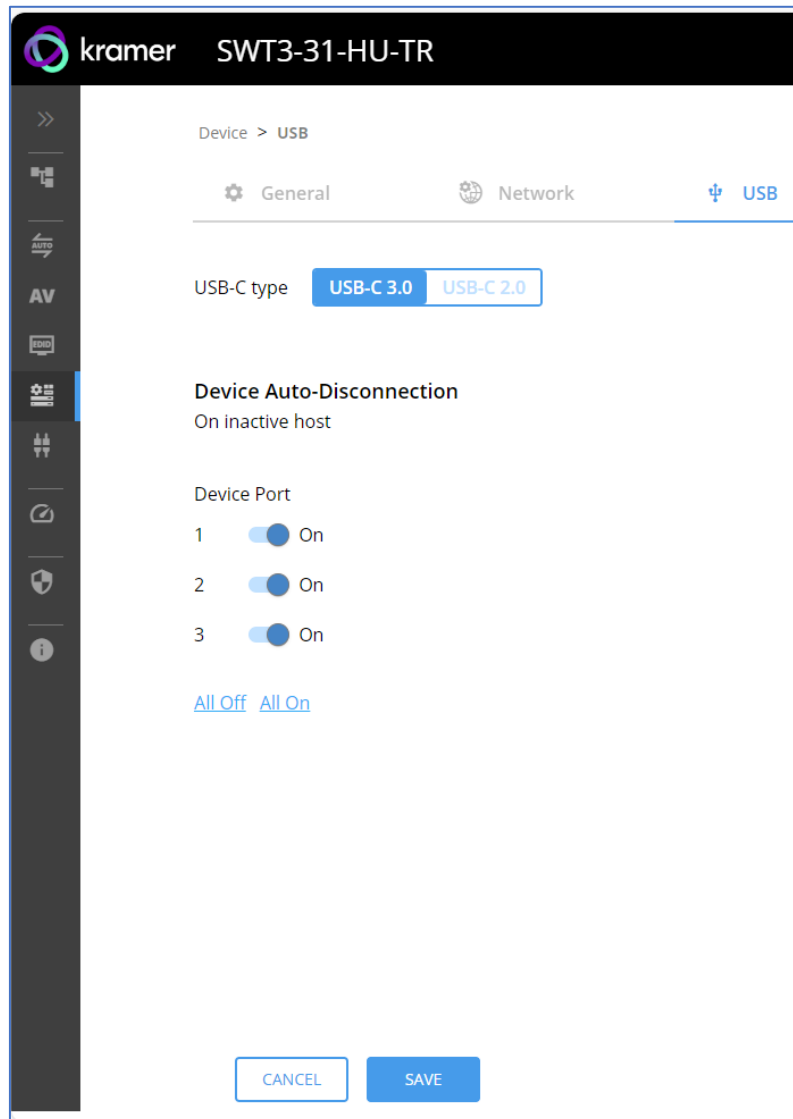

Figure 30: USB Page – USB Device Auto-Disconnection

3. For each USB Device Port, set the auto disconnection status to **On** or **Off**. You can also Select **All Off** or **All On** to set all device ports to off or on, respectively.
4. Click **SAVE**.

USB devices are set.

Setting Time and Date

You can sync the device time and date to any server around the world.

To sync device time and date to a server:

1. In the Navigation pane, click **Device**. The General tab in the Device page appears.
2. Select the **Time and Date** tab. The Time and Date tab appears.

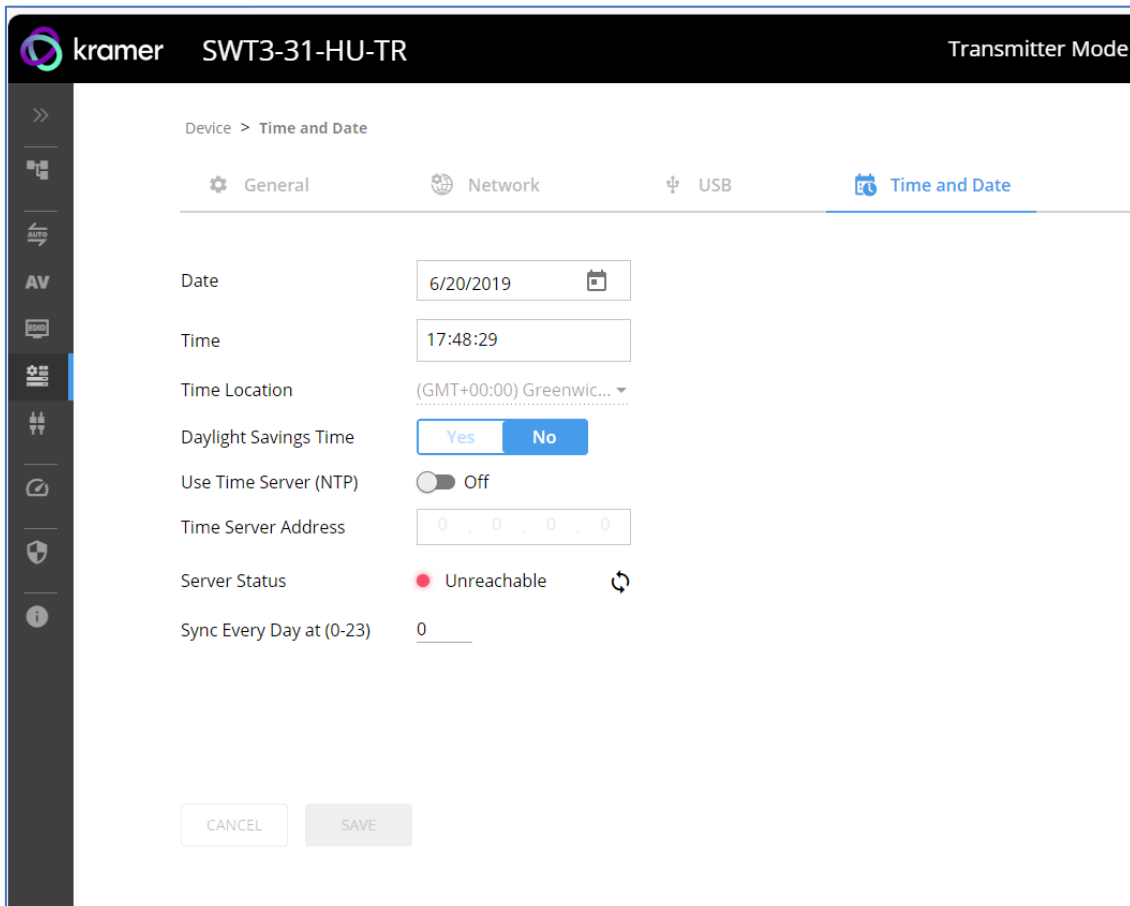

Figure 31: Device Settings – Time and Date Tab

3. Set the Date and Time.
4. Select the Time Location.
5. In the Use Time Server (NTP) drop-down box, click:
 - **Disabled** to disable the time server.
 - **Manual** to enable time server (NTP).
6. If enabled, type in server information:
 - Enter the time server address.
 - Set sync frequency (every 0 to 23 days).
7. Click **SAVE** for any change.

The devices date and time are synchronized to the server address entered.

Setting Control Gateway Properties

This section details the following actions:

- [Setting Serial Port Properties](#) on page [42](#).
- [Configuring I/O \(GPIO\) Ports](#) on page [48](#).
- [Defining and Testing Commands via Action Editor](#) on page [52](#).
- [Configuring Remote Buttons](#) on page [53](#).
- [Defining CEC Gateway](#) on page [54](#).
- [Associating Commands to DISPLAY ON/OFF](#) on page [55](#).
- [Setting IR Port Properties](#) on page [56](#).

Setting Serial Port Properties

The serial ports are serving for one of the following:

- RS-232 extension – From panel port, via HDBT RS-232 channel, to control a peripheral connected to the HDBT paired unit RS-232 port.
- External peripheral IP control – Remote IP control of port-connected peripheral, via device built-in control gateway.
- Device management and control – Device service and control using P3000 commands.

SWT3-31-HU-TR enables configuring the RS-232 port in one of the following ways:

- [Extending the RS-232 via the SWT3-31-HU-TR](#) on page [42](#).
- [Controlling the SWT3-31-HU-TR](#) on page [44](#).
- [Controlling an External Device](#) on page [45](#).
- [Controlling SWT3-31-HU-TR Connected Display](#) on page [47](#).

Extending the RS-232 via the SWT3-31-HU-TR

Setting the HDBT Extension Mode:

Set the HDBT for RS-232 local port extension to control the remote peripheral device.

To set the HDBT extension mode:

- 1. Go to the Control Gateway page. The Serial Ports tab appears.

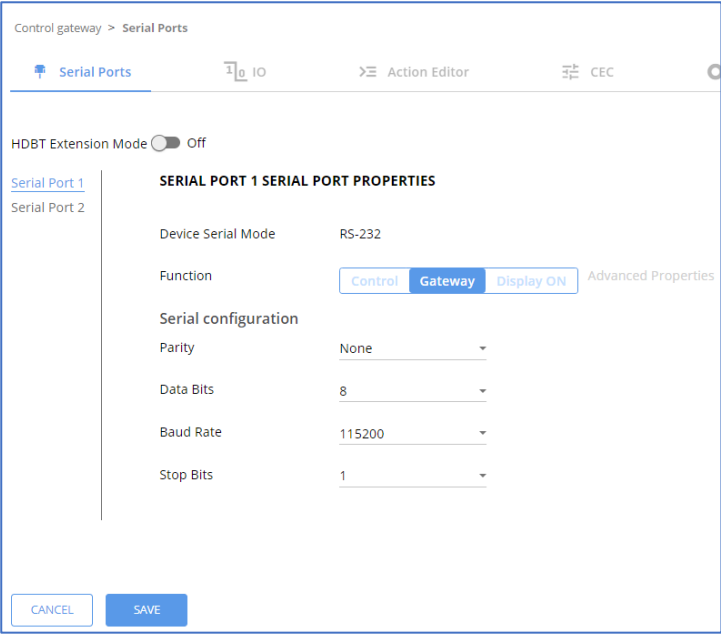

Figure 32: RS-232 Device Control

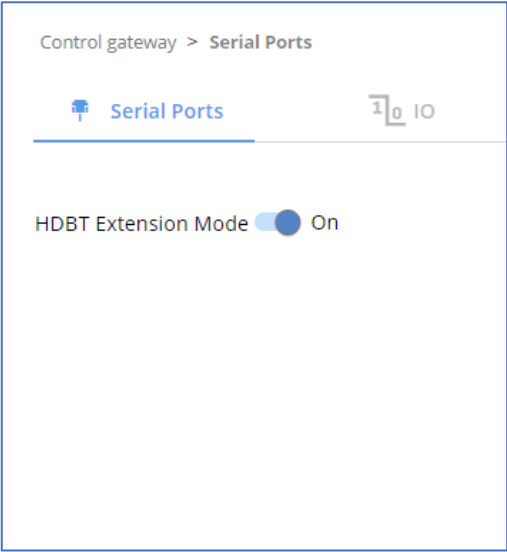

Figure 33: HDBT Extension Mode

- 2. Enable **HDBT Extension Mode** to ON (OFF is default mode).
 - **SWT3-31-HU-TR** is set to operate as an RS-232 extender, with end-to-end extension between RS-232 panel port and HDBT RS-232 channel.



In extension mode, no configuration of port properties and functions are available ([Figure 33](#)).

Controlling the SWT3-31-HU-TR

To set the RS-232 port to control the device:

1. Go to the Control Gateway page. The Serial Ports tab appears.

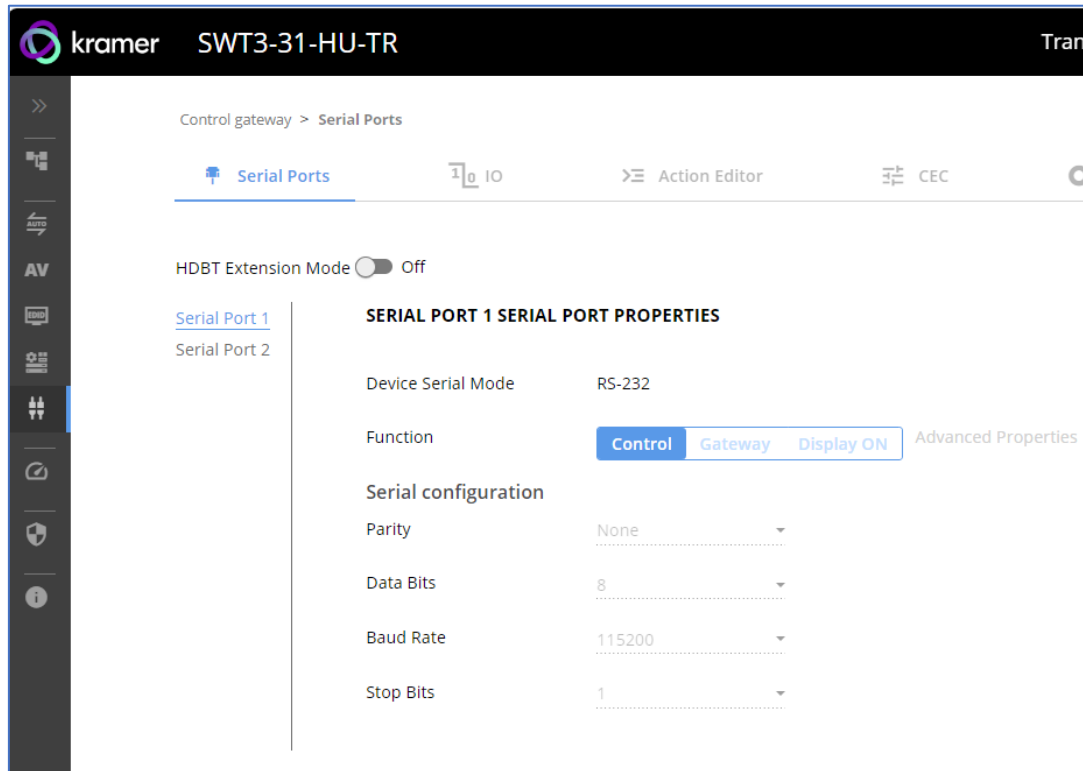

Figure 34: RS-232 Device Control

2. Next to Function, select **Control**.
3. Click **SAVE**.

RS-232 port controls the **SWT3-31-HU-TR**.

Controlling an External Device

Control an external device via an IP-connected Controller (for example **SL-240C** that is connected via LAN)

To set the RS-232 port to control an external device:

1. Go to the Control Gateway page. The Serial Ports tab appears.
2. Next to Function, select **Gateway**.

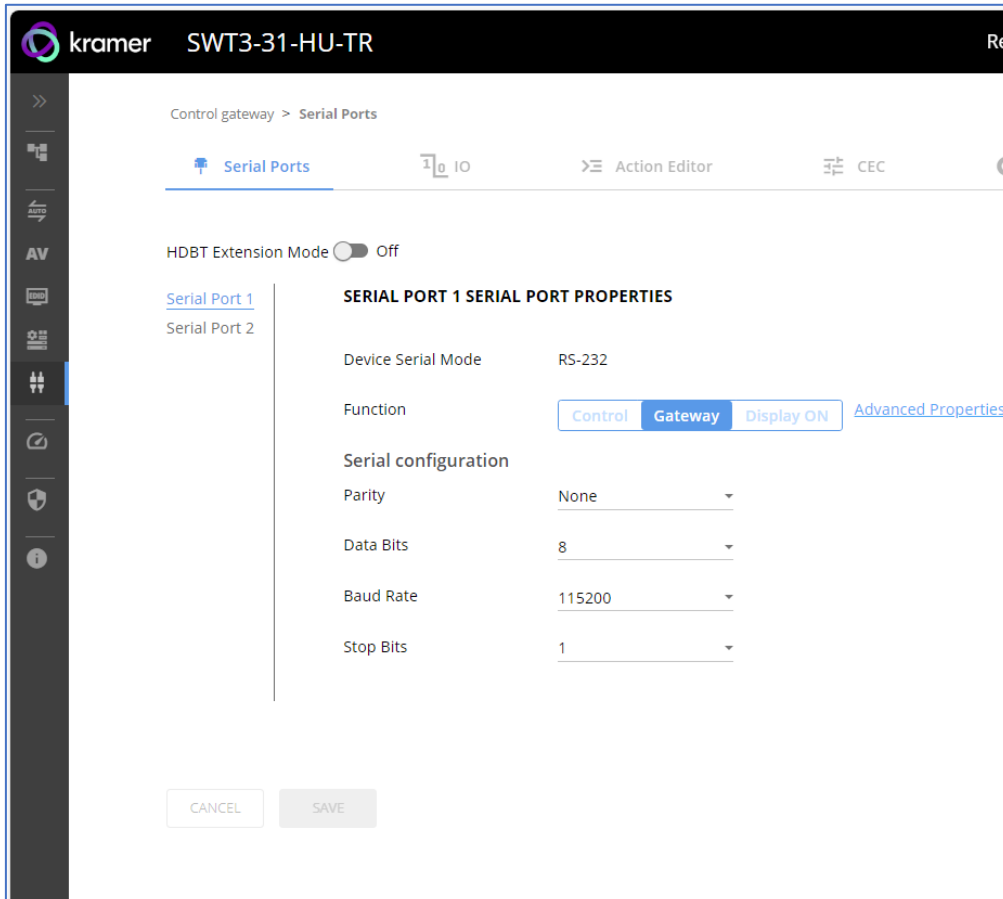

Figure 35: RS-232 as Gateway

3. Define the external device RS-232 settings (Parity, Data Bits, Baud Rate and Stop Bits).
4. Click **SAVE**.

The TUNNELING ADVANCED PROPERTIES screen appears.

TUNNELING ADVANCED PROPERTIES

Protocol TCP UDP

IP Port 5001

TCP Keep alive 10

Send replies to new client by default Bits On

CLOSE

Figure 36: Setting Advanced Tunneling Properties

5. Select either TCP or UDP port.
6. Click up/down arrows to select IP Port for sending commands to RS-232.
7. Click up/down arrows to select desired seconds for TCP Keep alive.
8. Press to toggle ON Send replies to new clients by default Bits.
9. Click **CLOSE**.
10. Click **SAVE**.

RS-232 port controls an external device.

Controlling SWT3-31-HU-TR Connected Display

Control the display (an external device), connected to **SWT3-31-HU-TR**, either remotely via HDBT output (on Tx mode) or locally via HDMI output (on Rx mode).

The **SWT3-31-HU-TR** sends serial, CEC or IR commands, defined by the user in the Action Editor (see [Defining and Testing Commands via Action Editor](#) on page 52) and then linked to the DISPLAY ON button (see [Associating Commands to DISPLAY ON/OFF](#) on page 54).

To set the RS-232 port to control the connected display:

1. Go to the Control Gateway page. The Serial Ports tab appears.
2. Next to Tunneling, select **Display ON**.

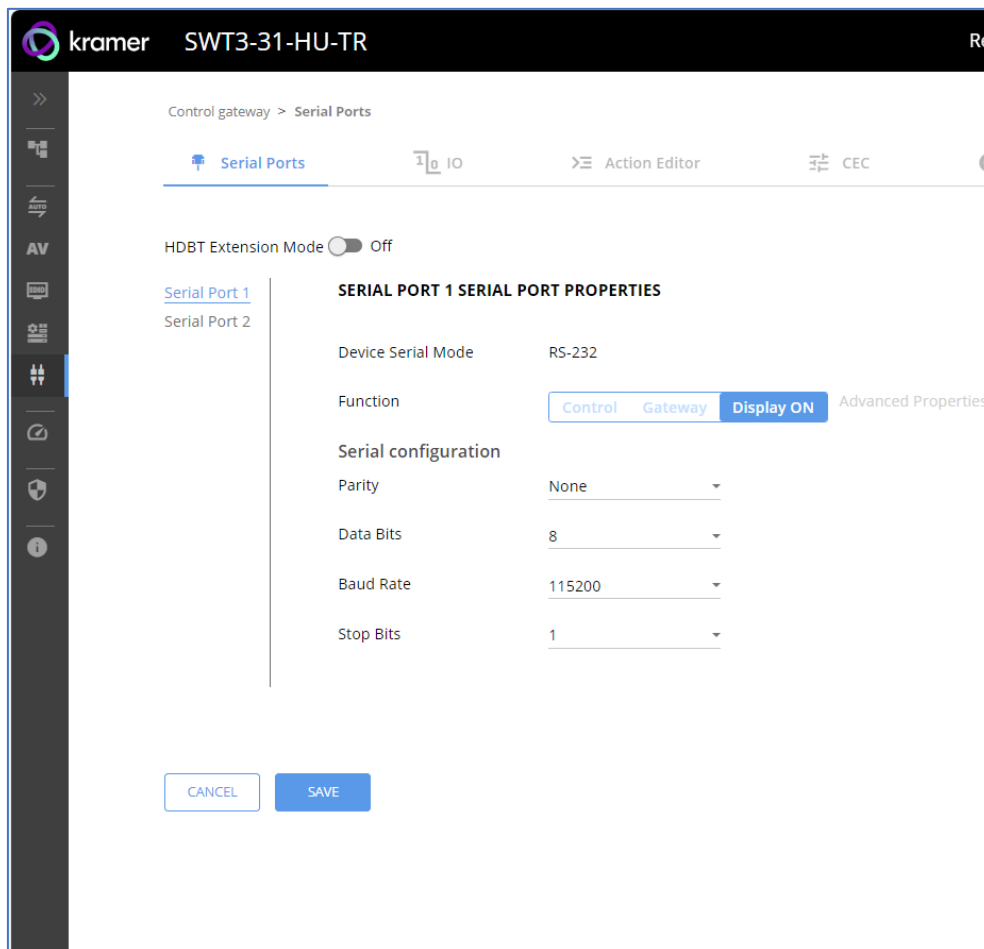



Figure 37: RS-232 Control for Display on/off

3. Define the display RS-232 settings (Parity, Data Bits, Baud Rate and Stop Bits).
4. Click SAVE.

RS-232 port controls the DISPLAY ON/OFF.

Configuring I/O (GPIO) Ports

The 2 I/O ports can control devices such as sensors, door locks, remote contact-closure buttons, audio volume and lighting control devices and can be configured via the webpages.

 To enable I/O operations, Remote Button must be set to Off.

To configure an I/O port:

1. In the Navigation pane, click **Control Gateway**. The Serial Ports tab in the Device Settings page appears.
2. Select the IO tab. The IO tab appears.

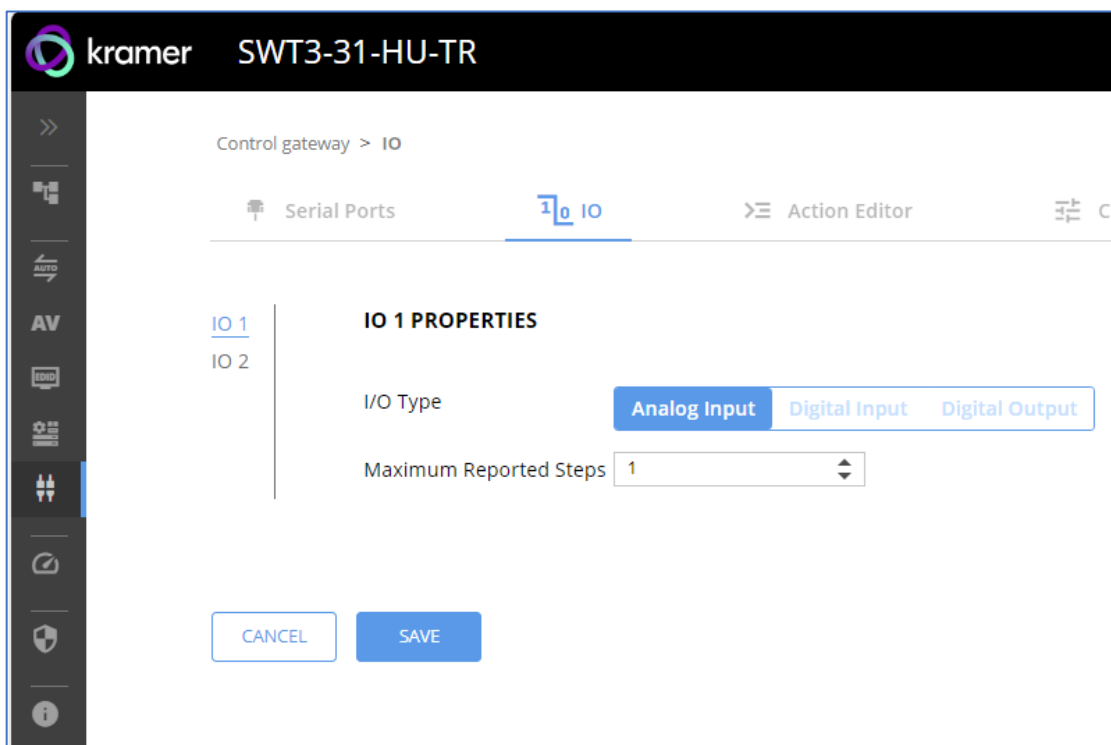



Figure 38: I/O Ports Settings Page

3. Select the I/O port to be configured (IO 1 or IO 2).
4. Select one of the following I/O types:
 - **Digital Input (default setting)** (see [Configuring a Digital Input I/O Type](#) on page 49).
 - **Digital Output** (see [Configuring a Digital Output I/O Type](#) on page 49).
 - **Analog Input** (see [Configuring an Analog Input I/O Type](#) on page 51).

 The settings available on the page change depending on which trigger type is selected.

5. Click **SAVE** after setting the selected I/O type.

Configuring a Digital Input I/O Type

The Digital Input trigger mode reads the digital input of an external sensor device that is connected to the I/O port. It detects High (upon passing Max threshold from Low state) or Low (upon passing Min threshold from High state) port states according to the user defined voltage threshold levels.

To configure a digital input I/O type:

1. On the GPIO page, select **Digital Input** next to I/O Type.
The Digital Input options appear ([Figure 38](#)).
2. Select one of the following for the Pull-up resistor setting:
 - **Disabled**
Suitable, for example, for a high temperature alarm that exceeds the maximum voltage threshold. When the pull-up resistor is disabled, the port state is low and to be triggered it must be pulled high by the externally connected sensor.
 - **Enabled** – Detection of an open circuit as High, or a short to ground as Low.
This is suitable for example, for a pushbutton switch (connecting one terminal of the switch to ground, and the other to the input) or for an alarm closing a circuit that activates a series of actions. When the pull-up resistor is enabled, the port state is high, and to be triggered it must be pulled low by the externally connected sensor.
3. Set the Threshold VDC Low and High Range (threshold voltage at which the port changes state).
4. Click **Read** to refresh port status information.
5. Click **SAVE**.

Digital input I/O type is configured.

Configuring a Digital Output I/O Type

To configure a digital output I/O type:

1. On the GPIO page, select Digital Output next to I/O type.
A warning message appears.

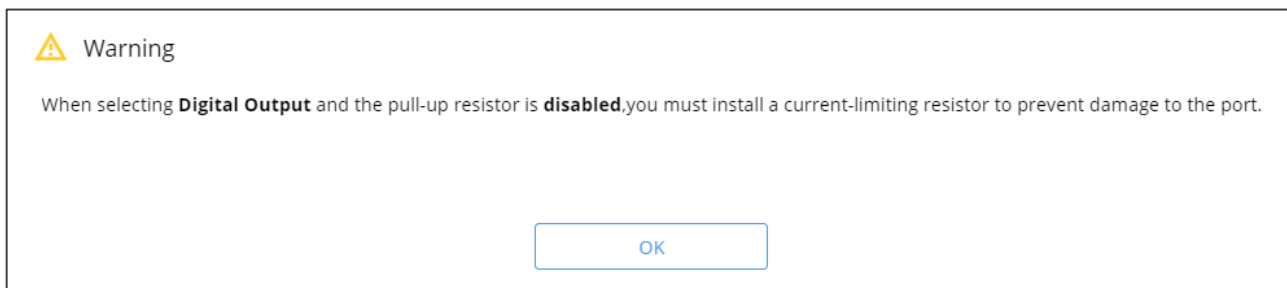

Figure 39: Digital Output Warning

2. Make sure to follow the instructions in this warning.

3. Click **OK**. The Digital Output options appear.

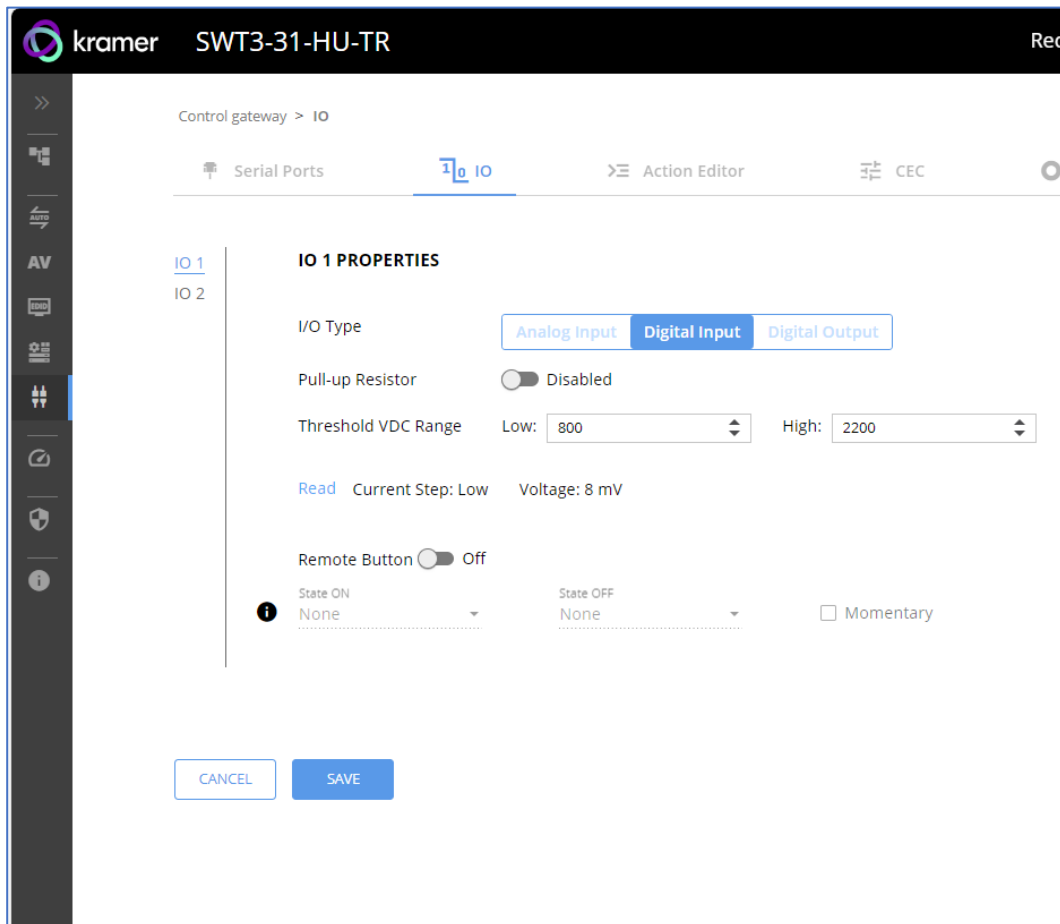



Figure 40: GPIO Settings Page – Digital Output I/O Type

4. Select one of the following for the Pull-up resistor setting:

- Pullup resistor set to **Enabled**:
The port can be used for controlling devices that accept a TTL signal such as for powering LEDs. The voltage output is TTL positive logic: high: >2.4V; low: < 0.5V. When the pull-up resistor is enabled, the port state is high. For the state to be low, you must select **Low** for the Current Status.
- Pullup resistor **Disabled**:
The port is used for controlling external devices such as room or light switches. The external source device determines the voltage output; the maximum voltage is 30V DC and the maximum current is 100mA. When the pull-up resistor is disabled, the port state is low. For the state to be high, select **High** for the Current Status.

 Make sure that the current in this configuration does not exceed 100mA.

5. Click **SAVE**.

Digital Output I/O type is configured.

Configuring an Analog Input I/O Type

When selecting the Analog Input I/O type, the port is triggered by an external analog device, such as a volume control device. The trigger is activated once when the detected voltage is within the 0 to 30V DC voltage range.

To configure an analog input I/O type:

1. On the GPIO page, select Analog Input next to I/O type.

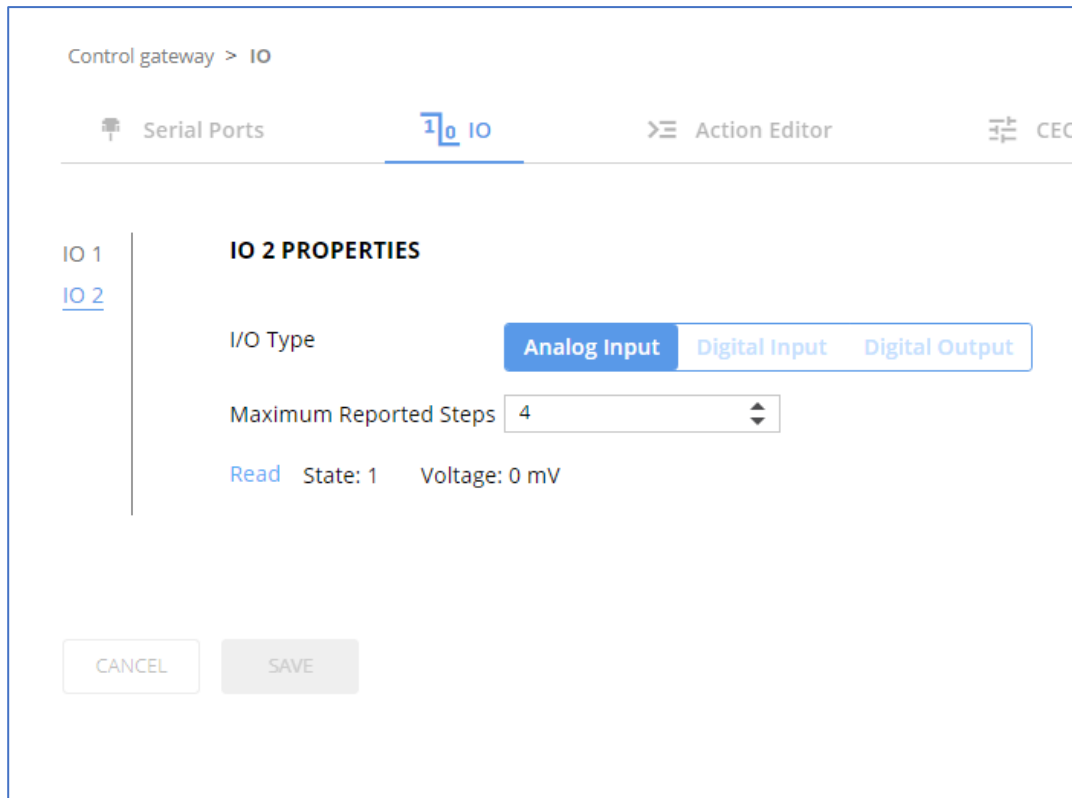

Figure 41: GPIO Port Settings Page Analog Input

2. Enter or use the arrows to scroll to a value (1–100) for the Maximum reported steps. This value is the number of steps that the analog input signal is divided into. To calculate the voltage of each step, use the following formula:
Voltage of one step = 30V / number of steps.

3. Click **SAVE**.

Analog input I/O type is configured.

Defining and Testing Commands via Action Editor

Use action editor to create and test control commands via CEC, UART or IR control interfaces. You can create up to 5 commands.

To add an action:

1. In the navigation pane, select **Control Gateway**. The Serial Ports tab opens.
2. Select the **Action Editor** tab. The Action Editor appears.

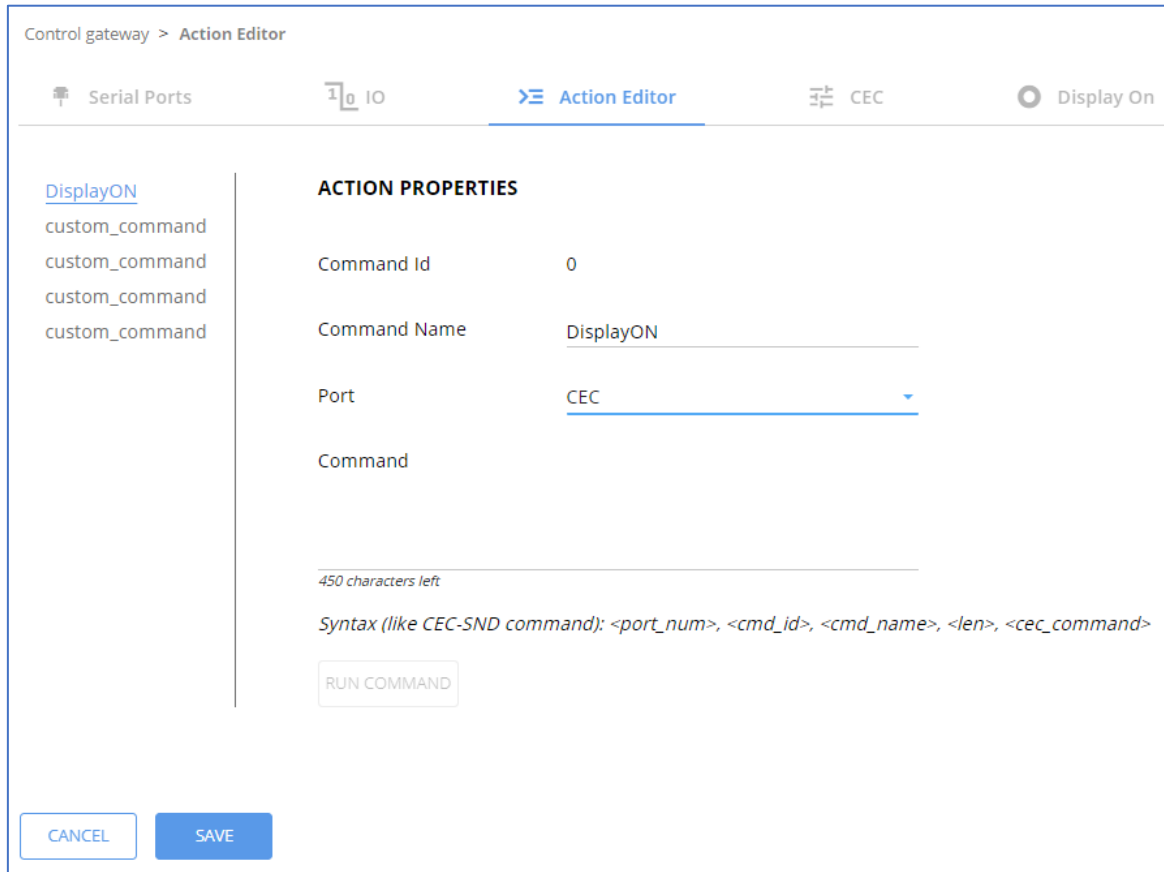

Figure 42: Action Editor Tab

3. Select a command name on the left side of the window.
4. Change the command name, if required.
5. Select the port (CEC, UART or IR).



For Tx: via HDBT output

For Rx: via HDMI output

6. Enter the appropriate command line, such as one of the following Display On sample commands:

- For CEC - 1,1,tv-on,2,E004



The command to power on a TV can vary depending on the specific TV model and manufacturer. However, above is a common example of a standard command to power on a TV.

- For RS232 - PON

- For IR -
1,1,TVON,1,1,1,0000,006f,0022,0002,014d,00a6,0015,0015,0014,0015,0013,0014,0015,0015,0014,0014,0014,0014,0014,0015,0015,0014,003e,0016,003d,0014,003f,0014,003e,0015,003f,0013,003f,0014,003e,0015,003f,0013,0016,0013,0015,0014,0015,0013,0016,0013,003f,0013,003e,0015,0015,0013,003e,0015,003f,0013,003f,0013,003e,0015,003e,0015,0015,0014,0015,0013,003f,0014,0015,0013,0014,0015,05c9,014d,0053,0015,0e0a
7. Click **SAVE**.
 8. Click **RUN COMMAND** to run the command test.
- An action is entered and can be run.

Configuring Remote Buttons

Remotely operate, by I/O-connected remote buttons, configured control actions (see (see [Defining and Testing Commands via Action Editor](#) on page 52).

To Configure Remote Buttons:

1. In the Navigation pane, click **Control Gateway**. The Serial Ports tab in the Device Settings page appears.
2. Select the IO tab. The IO tab appears.
3. Press to toggle **Remote Button** to On.
4. Configure defined control actions, for button on/off states, using the **State ON**, **State OFF** drop-down boxes.
 - Button default operation mode is latching. For momentary mode, check the Momentary checkbox.

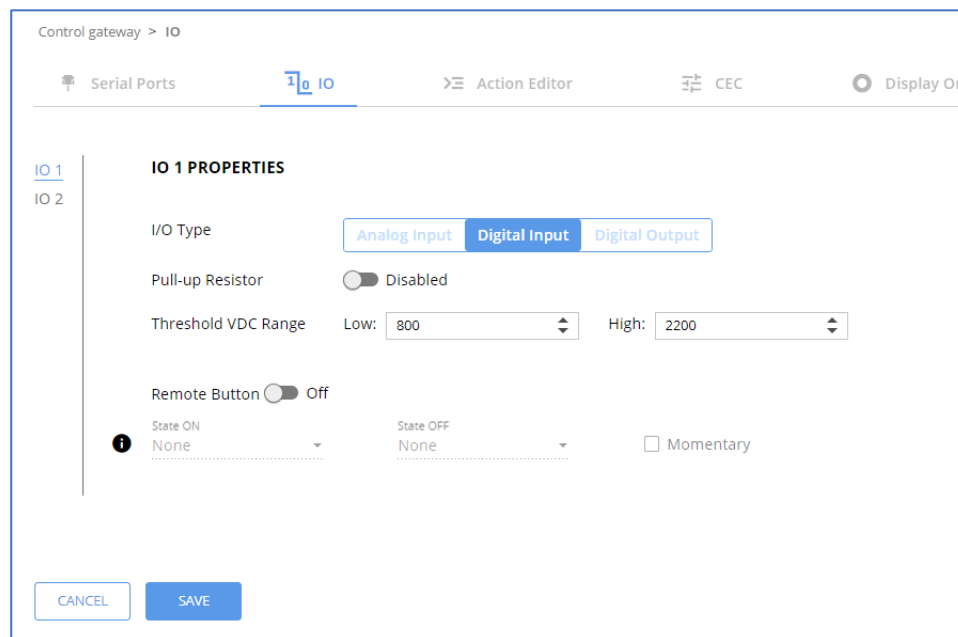

Figure 43: I/O ports settings tab – Configuring Remote Buttons

5. Click **SAVE**.

A control actions remote button can now be remotely operated.

Defining CEC Gateway Settings

SWT3-31-HU-TR built-in CEC gateway enables IP control of control system, via CEC messages, on HDMI connected devices to the selected input and the output port. The Members address list shows the logical addresses of connected CEC-enabled devices.



- Rx: CEC gateway is disabled by default, Tx CEC gateway enabled by default.
- Tx via HDBT, Rx to local HDMI

1. In the navigation pane, select **Control Gateway**. The Serial Ports tab opens.
2. Select the **CEC** tab. The CEC Gateway page appears.
3. Click CEC gateway **OFF**.

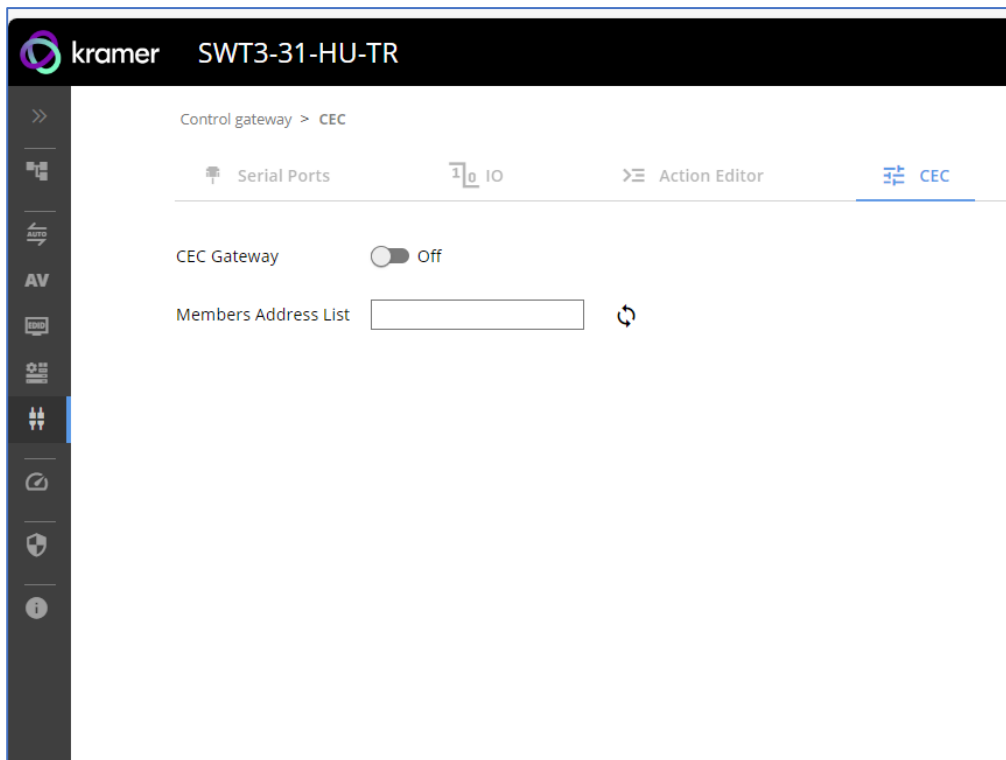

Figure 44: CEC Gateway Enable/Disable Tab

CEC gateway is disabled.

You can view the logical addresses of CEC-enabled devices that are connected via HDMI output port to SWT3-31-HU-TR and click **Refresh** to refresh the list.

Associating Commands to DISPLAY ON/OFF

Configure CEC commands to send via DISPLAY ON button.

To add an action:

1. In the navigation pane, select **Control Gateway**. The Serial Ports tab opens.
2. Select the **Display On** tab. The Display ON settings appears.

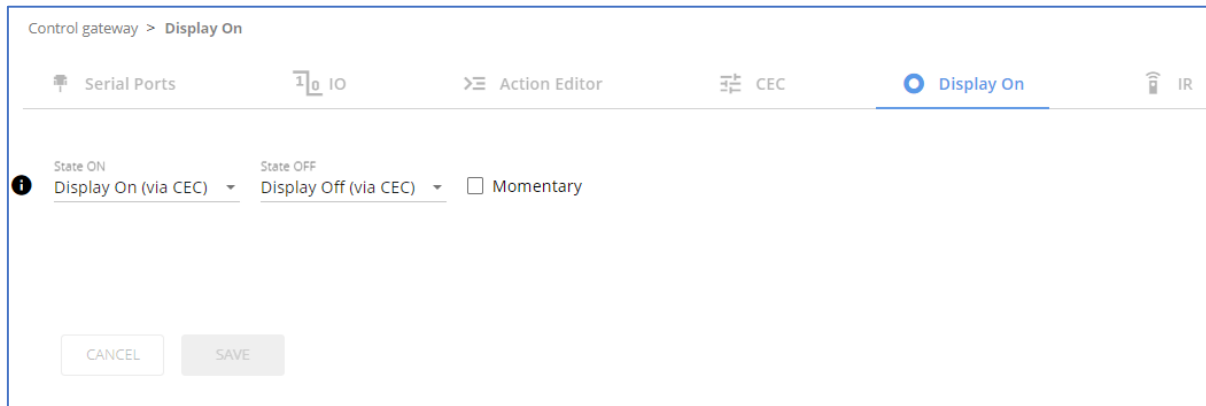

Figure 45: Action Editor Tab

3. Define the State On and State Off commands.
4. Check **Momentary** for the button to send a command on the press of a button.
5. Click **SAVE**.

DISPLAY ON button is configured.

Setting IR Port Properties

SWT3-31-HU-TR has two IR ports:

- IR 1 – Panel IR port
- IR 2– HDBT IR channel

The IR ports are serving for one of the following:

- IR extension (HDBT IR) – From panel IR port or Internal Gateway, via HDBT IR channel, to control a peripheral connected to the HDBT paired device IR port. IR signals sending method is transparent pass-thru of received IR signal only.
- IR Local (Panel IR) – From HDBT extension or Internal Gateway to Local (Panel) IR port. IR signals sending methods are as follows:
 - Pass-thru – Transparent pass-through of received IR signal (default).
 - Modulation – IR signal extension with 38KHz modulated IR signal output.

IR routing cross-point grid for Tx and Rx extension operation modes (see [Figure 46](#)), enable IR signals routing, as follows:

Tx Selected IR Port	Rx Selected IR Port	IR Routing Description
IR 1 (Panel IR)	IR 2 (HDBT IR)	Received IR signal from panel IR port is extended, via HDBT IR channel, to output on remote HDBT-connected IR port
IR 2 (HDBT IR)	IR 1 (Panel IR)	Received IR-extended signal via HDBT IR channel is output on local IR panel port
GATEWAY 3	IR 1 (Panel IR)	IR control gateway outputs IR-generated signal to IR panel port (to IR-control locally-connected peripheral)
GATEWAY 3	IR 2 (HDBT IR)	IR control gateway outputs IR-generated signal to HDBT IR channel (to IR-control remotely-connected peripheral)



SWT3-31-HU-TR enables concurrent control gateway signals output on both, IR panel port and HDBT channel.

Routing IR Signals

1. In the navigation pane, select **Control Gateway**.
2. Select the **IR** tab. The IR tab opens (see [Figure 46](#)).
3. Select Tx and Rx IR routing cross-points by clicking on their IR icons. Selected IR routing indication appears.

- 4. If needed, select modulation method by pressing **M** on Rx IR 1 cell (see [\(Figure 47\)](#)).
- 5. Click **SAVE**.

IR signals routing is set.

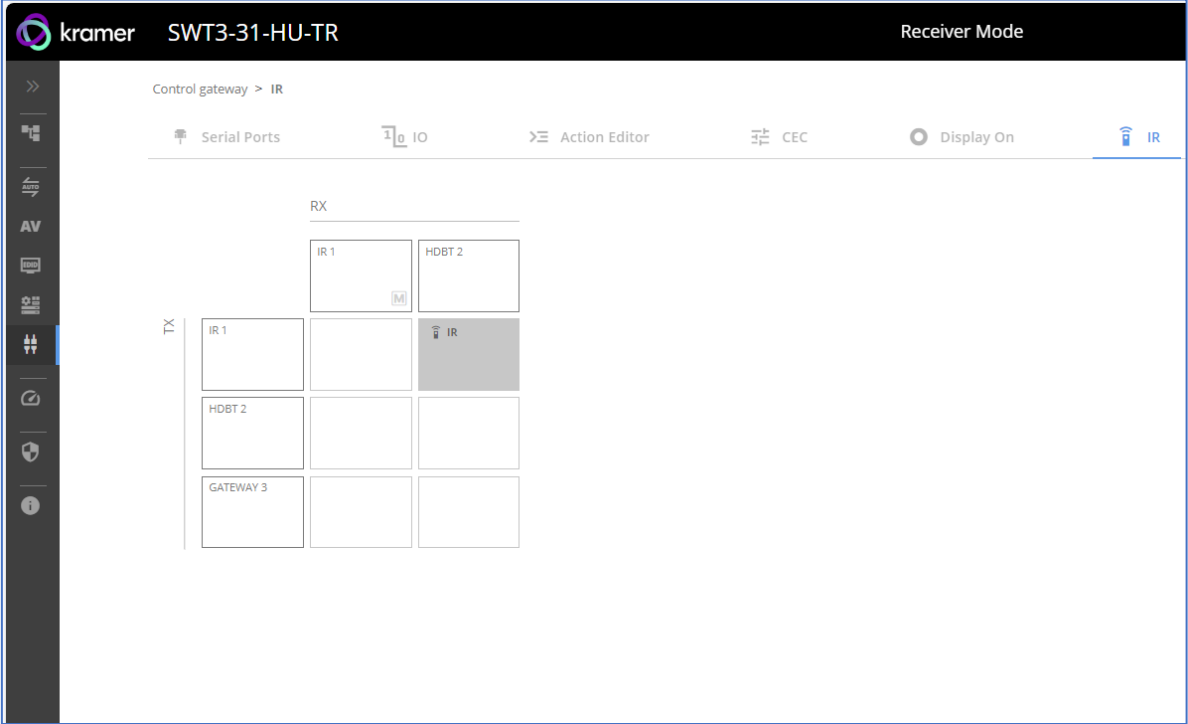

Figure 46: IR Tab Signals Routing

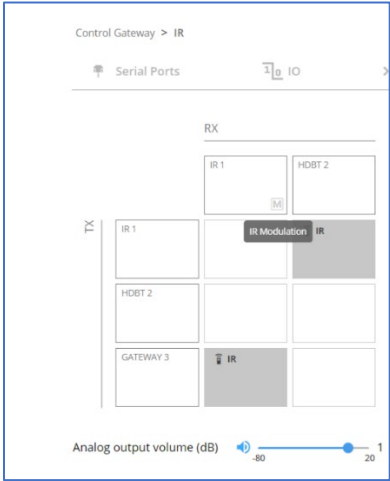

Figure 47: IR Modulation Method Setting

Viewing Device Status

View the device status.

To view the device status:

- 1. In the navigation pane, select **Status**.
- 2. Select the **Devices** tab. The Devices Status appears.

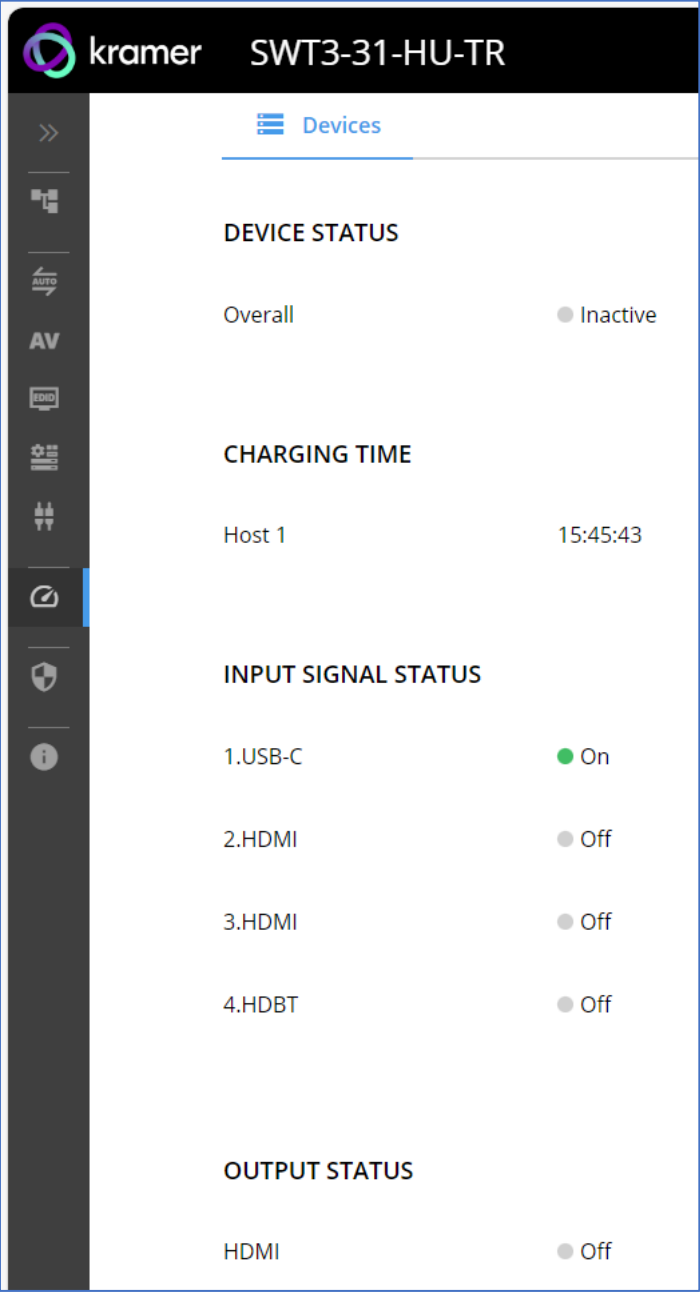

Figure 48: Device Status Page

- 3. View device status.

Device status can be viewed.

Setting Security Properties

This section details the following actions:

- [Changing Security Status](#) on page [59](#).
- [Defining 802.1X Authentication](#) on page [61](#).

Changing Security Status

By default, security status is set to On.

Setting Security Status to Off

To set security status to Off:

1. Go to the Security page ([Figure 49](#)).
2. Select the Security tab. The Security settings appears.

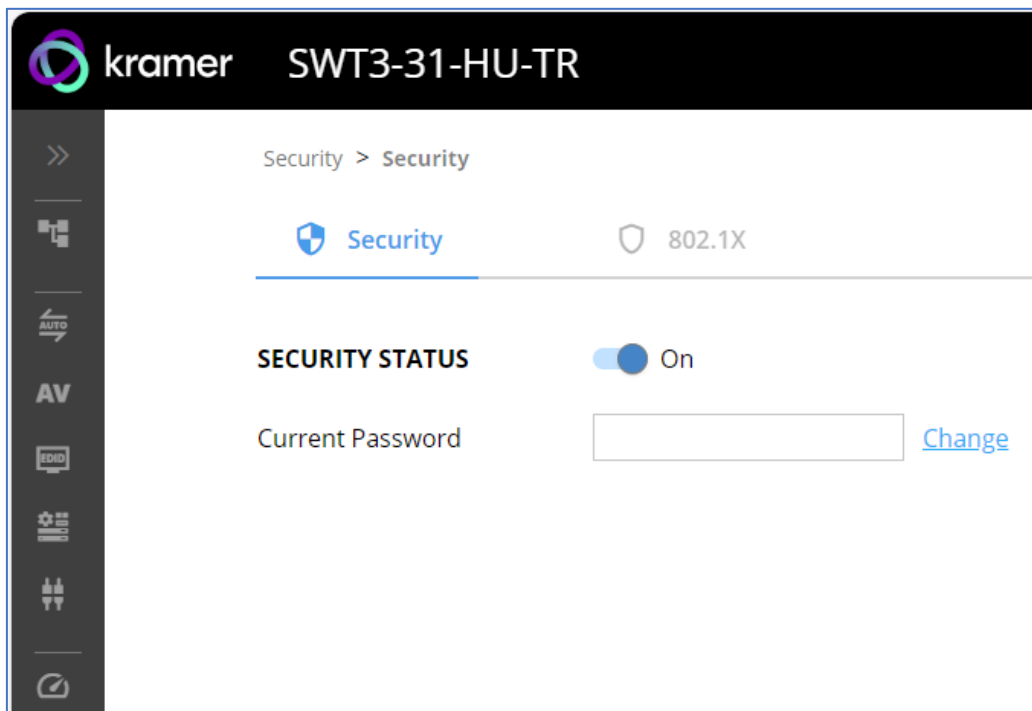

Figure 49: Security – Security Tab

3. Set **SECURITY STATUS** to **Off**. The Security Status window appears.

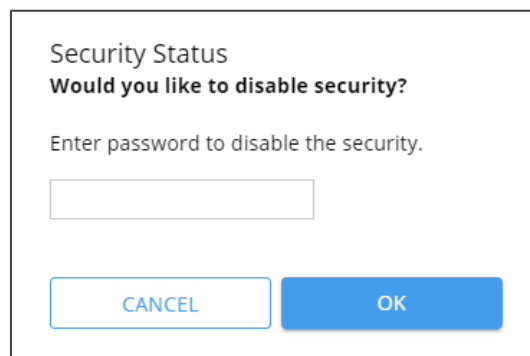

Figure 50: Security Status Message

4. Enter the current password.
5. Click **OK**.

Security status is set to Off.

Setting Security Status to On

To set security status to on:

1. Go to the Security > Security ([Figure 49](#)).
2. Set SECURITY STATUS to **On**.

Security status is set to On.

Changing Web Pages Access Password

To change the password for accessing the embedded web pages:

1. Go to the Security page ([Figure 22](#)).
2. Select the Security Tab. The Security settings appear ([Figure 51](#)).
3. Enter the Current Password and click **Change**. The new password settings appear.

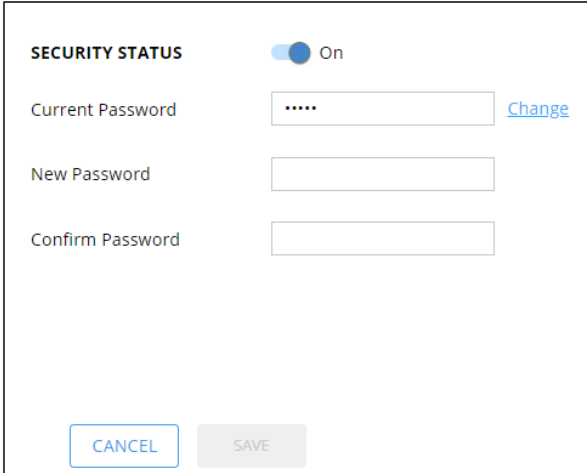

The screenshot shows a web interface for security settings. At the top, 'SECURITY STATUS' is set to 'On' with a blue toggle switch. Below this are three input fields: 'Current Password' (containing five dots), 'New Password', and 'Confirm Password'. To the right of the 'Current Password' field is a blue 'Change' link. At the bottom of the form are two buttons: 'CANCEL' and 'SAVE'.

Figure 51: Device Settings – Changing the Password

4. Enter the new password and confirmation password and click **SAVE**.

The password is changed.

Defining 802.1X Authentication

802.1x security standard supports IT networking authentication based on LAN port and MAC address.

To configure security:

1. In the Navigation pane, click **Security**. The Security settings tab in the Security page appears.
2. Select **802.1X** tab. The 802.1X settings tab appears (see [Figure 52](#)).

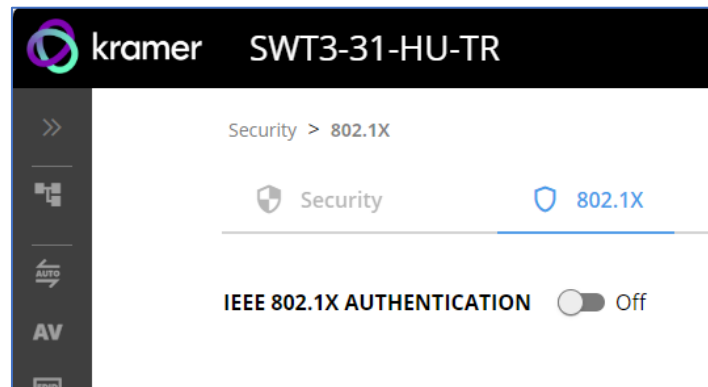

Figure 52: 802.1X Tab

3. For 802.1x authentication, click **ON** to enable 802.1x authentication service. 802.1x supports authentication based on port and MAC address.
4. When set to ON check one standard authentication method to set its security attributes.
 - **EAP-MSCHAP V2** – Enter:
 - Username - up to 24 alphanumeric characters, including “_” and “-“ characters within the username, and
 - Password - up to 24 ASCII characters

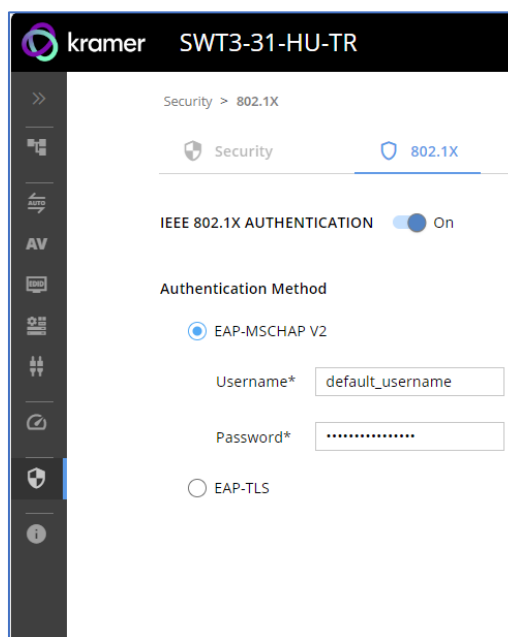



Figure 53: EAP-MSCHAP V2 Authentication Method

- **EAP-TLS** – To submit certificate from the server for authentication:

- Enter Username,
- Click  to upload the certificates and keys.

 File format must be pem.

- Enter the private key password (assigned by IT administrator),
- Set Server Certificate **On**

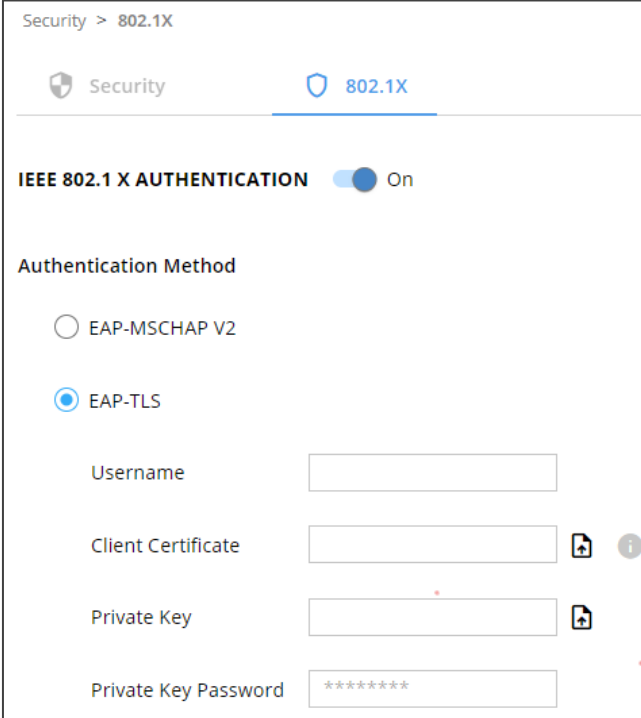

Security > 802.1X

Security 802.1X



IEEE 802.1 X AUTHENTICATION On

Authentication Method

EAP-MSCHAP V2

EAP-TLS

Username

Client Certificate  

Private Key 

Private Key Password

Figure 54: EAP-TLS – Certificates and Password

5. Click **APPLY**.

802.1x authentication security is configured.

Viewing the About Page

View the firmware version and Kramer Electronics Ltd details in the About page.

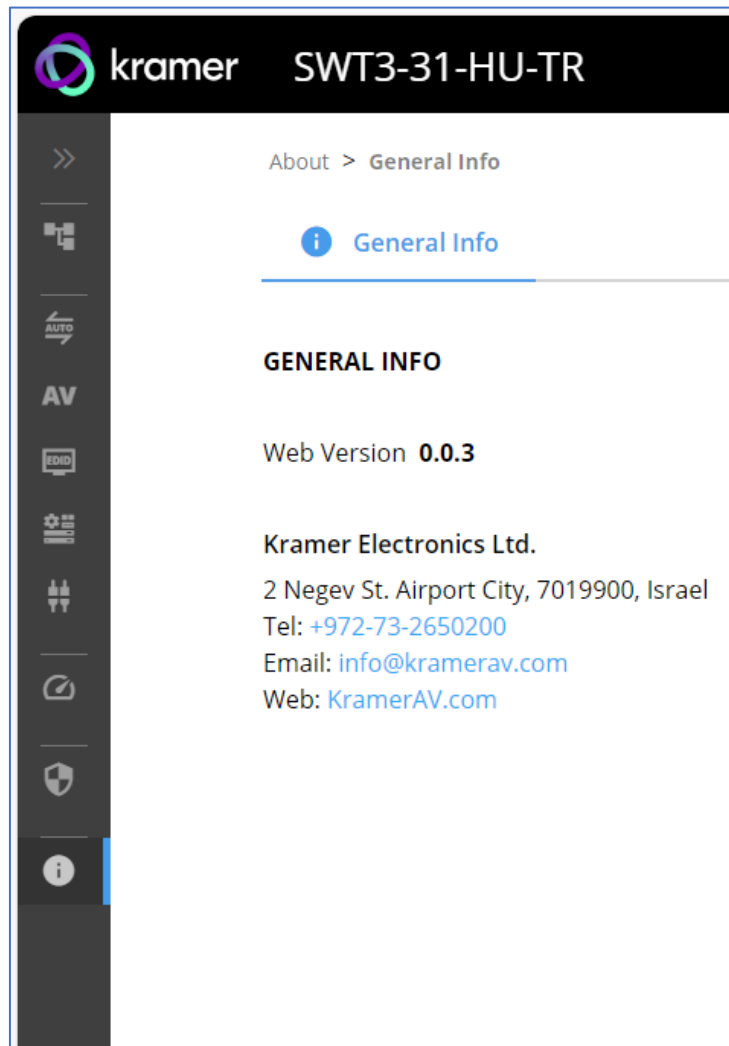

Figure 55: About Page

Upgrading Firmware

Use the Kramer **K-UPLOAD** software to upgrade the firmware via ethernet or the RS-232 port, allowing RS-232 to control/program the device). The device continues to operate and once FW upload complete, you are asked to Restart no or later.

The latest version of **K-UPLOAD** and installation instructions can be downloaded from our website at: www.kramerav.com/support/product_downloads.asp.



Note that in order to use the micro USB port, you need to install the Kramer USB driver, available at: www.kramerav.com/support/product_downloads.asp.

Technical Specifications

Inputs	2 HDMI	On HDMI female connectors
	1 DP Alt Mode & PD 3.0 USB-C	On a USB type-C female connector
	1 HDBT 2-way PoE	On an RJ-45 female connector
Outputs	1 HDMI (transmitter side)	On an HDMI female connector
	1 Balanced Stereo Line Level	On a 5-pin terminal block connector
	1 HDBT 2-way PoE	On an RJ-45 female connector
Ports	3 USB 3.2 Host	On a USB-C & USB-B female connectors
	3 USB 3.2 Device	On USB type-A female connectors
	1 PoE accepting 1000BaseT Ethernet	On an RJ-45 female connector for LAN connection & extension
	1 RS-232	On a 3-pin terminal block
	1 IR	On a 3.5mm mini jack for IR extension
	2 GPIO	On a 2-pin terminal block
Extension Line	Reach	Up to 100m (330ft), using Kramer HDBaseT cables
	Standards Compliance	HDBaseT 3.0
USB Features	USB 3.2 Data Rate	Up to 10Gbps
	Integrated USB Hubs	1
	Standards Compliance	USB 3.2 GEN 2, 2.0 and 1.1
Extended USB	USB 2.0 Data Rate	Up to 480Mbps
	Transmitted Data Bandwidth	Up to 300Mbps
	Standards Compliance	USB 2.0 and 1.1
Extended Ethernet	Max Data Rate	1 Gbps
Extended RS-232	Baud Rate	300 to 115200
Video	Max Data Rate	18Gbps bandwidth (6Gbps per graphic channel)
	Max Resolution	4K@60Hz (4:4:4) resolution
	Content Protection	HDCP 2.3
	HDMI Support	Deep Color, 3D, HDR as specified in HDMI 2.0b
Analog Audio	Max Output Signal Level	15dBu
	Impedance	500Ω
	Bandwidth	20Hz — 20kHz
	THD + N:	0.002% @1kHz at nominal level
	S/N Ratio	-93dB, 20Hz — 20kHz
	Coupling	DC
Power	Power Adapter	20VDC
		Max. Consumption: 6A
		Max. Power: 120W
	LAN PoE	Consumption: 144mA
		Max. Power: 7.8W
	USB Charging	Max. Power: 60W
		 When powered with 20V power supply only
USB Device Charging	Compliance: PD 3.0	
		Max. Total Current: 2A

Environmental Conditions	Operating Temperature	0° to +40°C (32° to 104°F)
	Storage Temperature	-40° to +70°C (-40° to 158°F)
	Humidity	10% to 90%, RHL non-condensing
Regulatory Compliance	Safety	CE, UL, UKCA
	Environmental	RoHs, WEEE
Enclosure	Size	1/2 19" 1U
	Cooling	Heat Sink
General	Net Dimensions (W, D, H)	21.46cm x 16.3cm x 4.36cm (8.4" x 6.4" x 1.71")
	Shipping Dimensions (W, D, H)	34.5cm x 21cm x 6.7cm (13.6" x 8.2" x 2.6")
	Net Weight	0.82kg (1.8lbs)
	Shipping Weight	1.28kg (2.8lbs) approx.
Accessories	Included	20V Power adapter and cords, USB-C multi-signal cable
Specifications are subject to change without notice at www.kramerav.com		

Default Communication Parameters

RS-232	
Baud Rate:	115,200
Data Bits:	8
Stop Bits:	1
Parity:	None
Command Format:	ASCII
Example (Route video input 2 to the output):	#ROUTE_1,1,2<CR>
Ethernet	
To reset the IP settings to the factory reset values go to: Menu->Setup -> Factory Reset-> press Enter to confirm	
Fallback IP Address:	192.168.1.39
Fallback Subnet mask:	255.255.255.0
Fallback gateway:	192.168.0.1
Default username:	Admin
Default password:	Admin
Full Factory Reset	
P3K	<p>"#FACTORY" command.</p> <p>After receiving "FACTORY OK" perform one of the following to restart the device and complete the procedure:</p> <ul style="list-style-type: none"> • Power cycle • Send command "#RESET"
Embedded webpages	Go to: Device>General and click FACTORY RESET

Protocol 3000

Kramer devices can be operated using Kramer Protocol 3000 commands sent via serial or Ethernet ports.

Understanding Protocol 3000

Protocol 3000 commands are a sequence of ASCII letters, structured according to the following.

- **Command format:**

Prefix	Command Name	Constant (Space)	Parameter(s)	Suffix
#	Command	_	Parameter	<CR>

- **Feedback format:**

Prefix	Device ID	Constant	Command Name	Parameter(s)	Suffix
~	nn	@	Command	Parameter	<CR><LF>

- **Command parameters** – Multiple parameters must be separated by a comma (,). In addition, multiple parameters can be grouped as a single parameter using brackets ([and]).
- **Command chain separator character** – Multiple commands can be chained in the same string. Each command is delimited by a pipe character (|).
- **Parameters attributes** – Parameters may contain multiple attributes. Attributes are indicated with pointy brackets (<...>) and must be separated by a period (.).

The command framing varies according to how you interface with **SWT3-31-HU-TR**. The following figure displays how the # command is framed using terminal communication software (such as Hercules):

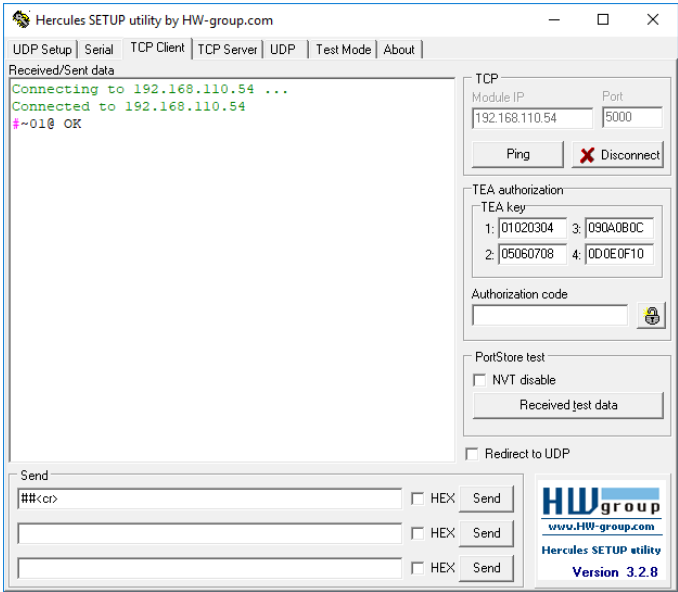

Protocol 3000 Commands

Function	Description	Syntax	Parameters/Attributes	Example
#	Protocol handshaking. ① Validates the Protocol 3000 connection and gets the machine number. Step-in master products use this command to identify the availability of a device.	COMMAND #<CR> FEEDBACK ~nn@_ok<CR><LF>		#<CR>
AUD-LVL	Set volume level.	COMMAND #AUD-LVL_<io_mode>,<io_index>,<vol_level><CR> FEEDBACK ~nn@AUD-LVL_<io_mode>,<io_index>,<vol_level><CR><LF>	io_mode – 1 – Output io_index – 1 vol_level – Volume level -100db to 15dB; ++ (increase current value by 1dB); -- (decrease current value by 1dB)	Set AUDIO OUT level to -50.0dB: #AUD-LVL_1,1,-50.0<CR>
AUD-LVL?	Get volume level.	COMMAND #AUD-LVL?_<io_mode>,<io_index><CR> FEEDBACK ~nn@AUD-LVL_<io_mode>,<io_index>,<vol_level><CR><LF>	io_mode – 1 – Output io_index – 1 vol_level – Volume level -100db to 15dB;	Get AUDIO OUT level: #AUD-LVL?_1,1<CR>
AUD-LVL-RANGE?	Get volume level min and max range.	COMMAND #AUD-LVL-RANGE?_<io_mode>,<io_index><CR> FEEDBACK ~nn@AUD-LVL-RANGE_<io_mode>,<io_index>,<min_val>,<max_val><CR><LF>	io_mode – 1 – Output io_index – 1 min_val – -100db max_val – 15dB	Get AUDIO OUT level range: #AUD-LVL-RANGE?_1,1<CR>
AUD-MUTE	Set audio mute.	COMMAND #AUD-MUTE_<out_index>,<mute_mode><CR> FEEDBACK ~nn@AUD-MUTE_<out_index>,<mute_mode><CR><LF>	out_index – 1 mute_mode – On/Off 0 – Off 1 – On	Set Output 1 to mute: #AUD-MUTE_1,1<CR>
AUD-MUTE?	Set audio mute.	COMMAND #AUD-MUTE_<out_index><CR> FEEDBACK ~nn@AUD-MUTE_<out_index>,<mute_mode><CR><LF>	out_index – 1 mute_mode – On/Off 0 – Off 1 – On	Get Output 1 to mute: #AUD-MUTE_1,1<CR>
AUD-MUTE-PERSIST	Set the auto audio unmute status upon volume change.	COMMAND #AUD-MUTE-PERSIST_<unmute_status><CR> FEEDBACK ~nn@AUD-MUTE-PERSIST_<unmute_status><CR><LF>	unmute_status – 0 – Mute state is not persistent and changes upon volume change 1 – Mute state is persistent upon volume change	Set mute mode to be persistent and not change upon volume change: #AUD-MUTE-PERSIST_1<CR>
AUD-MUTE-PERSIST?	Get the auto audio unmute status.	COMMAND #AUD-MUTE-PERSIST?_<unmute_status><CR> FEEDBACK ~nn@AUD-MUTE-PERSIST_<unmute_status><CR><LF>	unmute_status – 0 – Mute state is not persistent and changes upon volume change 1 – Mute state is persistent upon volume change	Get auto unmute status upon volume change: #AUD-MUTE-PERSIST?_<unmute_status><CR>
AUTH-802-1X-ENABLE	Set authentication 802.1X feature for the specific interface.	COMMAND #AUTH-802-1X-OP-STAT?_<interface ID><CR> FEEDBACK ~nn@AUTH-802-1X-ENABLE_<interface>,<enable_status><CR><LF>	interface – Interface ID – 0 enable_status – 0 – Off 1 – On	Get the authentication 802.1X operation status: #AUTH-802-1X-OP-STAT_0<CR>
AUTH-802-1X-ENABLE?	Get authentication 802.1X feature for the specific interface.	COMMAND #AUTH-802-1X-ENABLE?_<interface><CR> FEEDBACK ~nn@AUTH-802-1X-ENABLE_<interface>,<enable_status><CR><LF>	interface – Interface ID – 0 enable_status – 0 – Off 1 – On	Get the authentication 802.1X feature status: #AUTH-802-1X-ENABLE?_0<CR>
AUTH-802-1X-OP-STAT?	Get authentication 802.1X operational status.	COMMAND #AUTH-802-1X-OP-STAT_<interface ID><CR> FEEDBACK ~nn@AUTH-802-1X-OP-STAT_<interface ID>,<status><CR><LF>	interface – Interface ID – 0 Status – Status 0 – Not authenticated 1 – Authenticated	Get the authentication 802.1X operation status: #AUTH-802-1X-OP-STAT?_0<CR>
AV-SW-MODE	Set input auto switch mode (per output).	COMMAND #AV-SW-MODE_<layer_type>,<out_index>,<connection_mode><CR> FEEDBACK ~nn@AV-SW-MODE_<layer_type>,<out_index>,<connection_mode><CR><LF>	layer_type – Number that indicates the signal type: 1 – Video 2 – Audio out_index – 1 connection_mode – Connection mode 0 – manual 1 – priority switch 2 – last connected switch	Set the input audio switch mode to Manual for HDMI OUT: #AV-SW-MODE_1,1,0<CR>
AV-SW-MODE?	Get input auto switch mode (per output).	COMMAND #AV-SW-MODE?_<layer_type>,<out_index><CR> FEEDBACK ~nn@AV-SW-MODE_<layer_type>,<out_index>,<connection_mode><CR><LF>	layer_type – Number that indicates the signal type: 1 – Video 2 – Audio out_index – 1 connection_mode – Connection mode 0 – manual 1 – priority switch 2 – last connected switch	Get the input audio switch mode for HDMI OUT: #AV-SW-MODE?_1,1<CR>

Function	Description	Syntax	Parameters/Attributes	Example
AV-SW-TIMEOUT	Set auto switching timeout.	COMMAND #AV-SW-TIMEOUT_ <u>switching_mode</u> , <u>time_out</u> <CR> FEEDBACK ~nn@AV-SW-TIMEOUT_ <u>switching_mode</u> , <u>time_out</u> <CR><LF>	switching_mode – Switching mode 0 – Video signal lost 1 – New video signal detected 4 – Disable 5V on video output if no input signal detected 5 – Video cable unplugged 7 – Video signal lost for signal routed as a result of a manual override action time_out – Timeout in seconds 0 - 60000	Set the auto switching timeout to 5 seconds in the event of 5V disable when no input signal is detected: #AV-SW-TIMEOUT_ <u>4</u> , <u>5</u> <CR>
AV-SW-TIMEOUT?	Get auto switching timeout.	COMMAND #AV-SW-TIMEOUT?_ <u>switching_mode</u> <CR> FEEDBACK ~nn@AV-SW-TIMEOUT_ <u>switching_mode</u> , <u>time_out</u> <CR><LF>	switching_mode – Switching mode 0 – Video signal lost 1 – New video signal detected 4 – Disable 5V on video output if no input signal detected 5 – Video cable unplugged 7 – Video signal lost for signal routed as a result of a manual override action time_out – Timeout in seconds 0 - 60000	Get the auto switching timeout in the event of 5V disable when no input signal is detected: #AV-SW-TIMEOUT?_ <u>4</u> <CR>
BEACON-INFO?	Get beacon information, including IP address, UDP control port, TCP control port, MAC address, model, name.	COMMAND #BEACON-INFO?_ <u><CR></u> FEEDBACK ~nn@BEACON-INFO_ <u>port_id</u> , <u>ip_string</u> , <u>udp_port</u> , <u>tcp_port</u> , <u>mac_address</u> , <u>model</u> , <u>name</u> <CR><LF>	port_id – ID of the Ethernet port ip_string – Dot-separated representation of the IP address udp_port – UDP control port tcp_port – TCP control port mac_address – Dash-separated mac address model – Device model name – Device name	Get beacon information: #BEACON-INFO?_ <u><CR></u>
BUILD-DATE?	Get device build date.	COMMAND #BUILD-DATE?_ <u><CR></u> FEEDBACK ~nn@BUILD-DATE_ <u>date</u> , <u>time</u> <CR><LF>	date – Format: YYYY/MM/DD where YYYY = Year MM = Month DD = Day time – Format: hh:mm:ss where hh = hours mm = minutes ss = seconds	Get the device build date: #BUILD-DATE?<CR>
CEC-GW-PORT-ACTIVE	Set the CEC activation state.	COMMAND #CEC-GW-PORT-ACTIVE_ <u>direction_type</u> , <u>port_format</u> , <u>port_index</u> , <u>state</u> <CR> FEEDBACK ~nn@CEC-GW-PORT-ACTIVE_ <u>direction_type</u> , <u>port_format</u> , <u>port_index</u> , <u>state</u> <CR><LF>	direction_type – Direction of the port: out port_format – Type of signal on the port: hdbt port_index – The port number: 1 state – Global gateway activation state: o 0 – as a passthrough o 1 – as a gateway	Activate CEC for the HDBaseT port as a passthrough: #CEC-GW-PORT-ACTIVE_ <u>i</u> , <u>n</u> , <u>hdmi</u> , <u>1</u> , <u>0</u> <CR>
CEC-GW-PORT-ACTIVE?	Get the CEC activation state.	COMMAND #CEC-GW-PORT-ACTIVE?_ <u>direction_type</u> , <u>port_format</u> , <u>port_index</u> <CR> FEEDBACK ~nn@CEC-GW-PORT-ACTIVE_ <u>direction_type</u> , <u>port_format</u> , <u>port_index</u> , <u>state</u> <CR><LF>	direction_type – Direction of the port: out port_format – Type of signal on the port: hdbt port_index – The port number: 1 state – Global gateway activation state: o 0 – as a passthrough o 1 – as a gateway	Get the Activate CEC status for the HDBaseT port as a passthrough: #CEC-GW-PORT-ACTIVE_ <u>i</u> , <u>n</u> , <u>hdmi</u> , <u>1</u> <CR>
CEC-MEMBERS?	Get list of CEC logical addresses.	COMMAND #CEC-MEMBERS?_ <u>port_index</u> <CR> FEEDBACK ~nn@CEC-MEMBERS_ <u>port_index</u> ,<la1>,<la2>...<CR><LF>	port_index – 1 la – 1 to 15	Set gateway members: #CEC-MEMBERS?_ <u>1</u> <CR>
CEC-NTFY-ACTIVE	Set CEC notification activity (valid until the next power up).	COMMAND #CEC-NTFY-ACTIVE_ <u>cec_ntf</u> <CR> FEEDBACK ~nn@CEC-NTFY-ACTIVE_ <u>cec_ntf</u> <CR><LF>	cec_ntf – 0 – Inactive 1 – Active	Enable CEC notification: #CEC-NTFY-ACTIVE_ <u>1</u> <CR>
CEC-NTFY-ACTIVE?	Get CEC notification activity status.	COMMAND #CEC-NTFY-ACTIVE?_ <u><CR></u> FEEDBACK ~nn@CEC-NTFY-ACTIVE_ <u>cec_ntf</u> <CR><LF>	cec_ntf – 0 – Inactive 1 – Active	Get CEC notification activity status: #CEC-NTFY-ACTIVE?_ <u><CR></u>
CEC-SND	Send CEC command to port.	COMMAND #CEC-SND_ <u>port_index</u> , <u>sn_id</u> , <u>cmd_name</u> , <u>cec_len</u> , <u>cec_command</u> <CR> FEEDBACK ~nn@CEC-SND_ <u>port_index</u> , <u>sn_id</u> , <u>cmd_name</u> , <u>cec_mode</u> <CR><LF>	port_index – CEC port transmitting the command: 1 sn_id – 1 cmd_name – command name cec_len – 1–16 cec_command – CEC format command (in HEX format, no leading zeros, no '0x' prefix) cec_mode – CEC mode 0 – Sent 1 – Gateway disabled 2 – Inactive CEC-Master 3 – Busy 4 – Illegal Message Parameter 5 – Illegal CEC Address Parameter 6 – Illegal CEC Command 7 – Timeout 8 – Error	Send TV-OFF CEC command to the HDBaseT port: #CEC-SND_ <u>1</u> , <u>1</u> , <u>TV-OFF</u> , <u>2</u> , <u>e004</u> <CR>

Function	Description	Syntax	Parameters/Attributes	Example
COM-ROUTE?	Get tunneling port routing. ⓘ This command sets tunneling port routing. Every com port can send or receive data from the ETH port. Set command can edit an existing configuration.	COMMAND #COM-ROUTE?_com_id<CR> FEEDBACK ~nn@COM-ROUTE_com_id,port_type,port_id,eth_rep_en,ping_val<CR><LF>	com_id – Machine dependent, * (get all route tunnels) port_type – TCP/UDP 0 – TCP 1 – UDP port_id – TCP/UDP port number eth_rep_en – Ethernet Reply 0 – COM port does not send replies to new clients 1 – COM port sends replies to new clients. ping_val – Send an empty string to TCP client every 0 to 3600 seconds. 0 - 3600	Get tunneling port routing for all route tunnels: #COM-ROUTE?_*<CR>
COM-ROUTE-MODE	Set the communication at certain USRT port ⓘ Indexes not continuous because of bitwise operation (this is Mask values)	COMMAND #COM-ROUTE-MODE_uart_port,COM-MODE<CR> FEEDBACK ~nn@COM-ROUTE-MODE_uart_port,COM-MODE<CR><LF>	USRT Port – 1 – Control (p3k) 2 – Gateway (tunneling) 4 – Remote button Uart_port – Uart Port 1-N COM-MODE – communication mode that UART port is set to 1-Control 2- Gateway 4-Remote button)mask values and not continuous)	Change com-mode to Gateway (tunneling) #COM-ROUTE-MODE_1,2<CR>
COM-ROUTE-MODE?	Get the communication at certain USRT port ⓘ Indexes not continuous because of bitwise operation (this is Mask values)	COMMAND #COM-ROUTE-MODE?_uart_port,COM-MODE<CR> FEEDBACK ~nn@COM-ROUTE-MODE_uart_port,COM-MODE<CR><LF>	USRT Port – 1 – Control (p3k) 2 – Gateway (tunneling) 4 – Remote button Uart_port – Uart Port 1-N COM-MODE – communication mode that UART port is set to 1-Control 2- Gateway 4-Remote button) mask values and not continuous)	Get the communication mode of certain UART port. #COM-ROUTE-MODE?_1<CR>
CONF-EXPORT	Export configuration file	COMMAND #CONF-EXPORT_file_name<CR> FEEDBACK ~nn@CONF-EXPORT_file_name<CR><LF>	file_name – the name of the file we want to upload for the export.	Export configuration file: #CONF-EXPORT_file_name<CR>
CONF-IMPORT	Export configuration file	COMMAND #CONF-IMPORT_file_name<CR> FEEDBACK ~nn@CONF-IMPORT_file_name<CR><LF>	file_name – the name of the file we want to upload for the import.	Import configuration file: #CONF-IMPORT_EXT3-31-HU-TR-conf_file_name<CR>
COUNTER?	Get the sent or received CEC messages count.	COMMAND #COUNTER?_category_id,sub_category_id<CR> FEEDBACK ~nn@COUNTER_category_id,sub_category_id,count<CR><LF>	category_id – CEC messages: 0 Sub_category_id – Type of message: 0 – Sent message 1 – Received message count – Number range: 0-65535	Get the number of sent messages: #COUNTER?_0,0<CR>
COUNTER-CLR	Clear CEC messages.	COMMAND #COUNTER-CLR?_category_id,sub_category_id,clr<CR> FEEDBACK ~nn@COUNTER-CLR_category_id,sub_category_id,count<CR><LF>	category_id – CEC messages: 0 Sub_category_id – Type of message to clear: 0 – Clear sent messages 1 – Clear received messages * – Clear all CEC messages	Clear all CEC messages: #COUNTER-CLR?_0,*<CR>
CPEDID	Copy EDID data from the output to the input EEPROM. ⓘ Destination bitmap size depends on device properties (for 64 inputs it is a 64-bit word). Example: bitmap 0x0013 means inputs 1,2 and 5 are loaded with the new EDID. In certain products Safe_mode is an optional parameter. See the HELP command for its availability.	COMMAND #CPEDID_edid_io,src_id,edid_io,dest_bitmap<CR> or #CPEDID_edid_io,src_id,edid_io,dest_bitmap,safe_mode<CR> FEEDBACK ~nn@CPEDID_edid_io,src_id,edid_io,dest_bitmap<CR><LF> ~nn@CPEDID_edid_io,src_id,edid_io,dest_bitmap,safe_mode<CR><LF>	edid_io – EDID source type (usually output) 0 – Input 1 – Output 2 – Default EDID 3 – Custom EDID src_id – Number of chosen source stage 0 – Default EDID source 1 – HDBaseT OUT or USB-C IN 2 – HDMI IN edid_io – EDID destination type 0 – Input dest_bitmap – Bitmap representing destination IDs. Format: XXXX..X, where X is hex digit. The binary form of every hex digit represents corresponding destinations. 0 – indicates that EDID data is not copied to this destination. 1 – indicates that EDID data is copied to this destination. safe_mode – Safe mode (optional parameter) 0 – device accepts the EDID as is without trying to adjust (default value if no parameter is sent) 1 – device tries to adjust the EDID	Copy the EDID data from the HDBaseT Output to the HDMI Input: #CPEDID_1,1,0,0x1<CR>

Function	Description	Syntax	Parameters/Attributes	Example
CS-CONVERT	Set the "force RGB color space" convert mode.	COMMAND #CS-CONVERT_<out_index>,cs_mode<CR> FEEDBACK ~nn@CS-CONVERT_<out_index>,cs_mode<CR><LF>'	out_index – The port number: 1 cs_mode – color space mode: o 0 – Color space pass (default) o 1 – Enable "force RGB color space" convert mode	Enable force RGB color space: #CS-CONVERT_1,1<CR>
CS-CONVERT?	Get the "force RGB color space" convert mode.	COMMAND #CS-CONVERT?_<out_index><CR> FEEDBACK ~nn@CS-CONVERT_<out_index>,cs_mode<CR><LF>'	out_index – The port number: 1 cs_mode – color space mode: o 0 – Color space pass (default) o 1 – Enable "force RGB color space" convert mode	Get force RGB color space mode: #CS-CONVERT?_1<CR>
DEV-STATE?	Get the device state.	COMMAND #DEV-STATE?_<CR> FEEDBACK ~nn@DEV-STATE_<dev_state><CR><LF>'	dev_state – device state 0 – Active 1 – Power-on and no connected AV I/O ports (detecting cable connection faults) 2 – Power-on and standby (low power; cables are either connected or not)	Get device status: #DEV-STATE?_<CR>
DISPLAY?	Get output HPD status.	COMMAND #DISPLAY?_<out_index><CR> FEEDBACK ~nn@DISPLAY_<out_index>,status<CR><LF>	out_index – Number that indicates the specific output: 1 status – HPD status according to signal validation 0 – Signal or sink is not valid 1 – Signal or sink is valid 2 – Sink and EDID is valid	Get the output HPD status of Output 1: #DISPLAY?_1<CR>
EDID-AUDIO	Set audio capabilities for EDID.	COMMAND #EDID-AUDIO_<direction_type>.<port_format>.<port_index>.<signal_type>.<index>,audio_format<CR> FEEDBACK ~nn@EDID-AUDIO_<direction_type>.<port_format>.<port_index>.<signal_type>.<index>,audio_format<CR><LF>	The following attributes comprise the signal ID: ▪ <direction_type> – Direction of the port: o IN – Input o OUT – Output ▪ <port_format> – Type of signal on the port: o HDMI o ANALOG_AUDIO o USB_C ▪ <port_index> – The port number as printed on the front or rear panel ▪ <signal_type> – Signal ID attribute: o AUDIO ▪ <index> – Indicates a specific channel number when there are multiple channels of the same type audio_format – Audio block added to EDID: 0 – Auto 1 – LPCM 2CH 2 – LPCM 6CH 3 – LPCM 8CH 4 – Bitstream 5 – HD	Set HDMI IN 2 audio capabilities for EDID (LPCM 6CH): #EDID-AUDIO_in.hdmi.2.audio.1,2<CR>
EDID-AUDIO?	Get audio capabilities for EDID.	COMMAND #EDID-AUDIO?_<direction_type>.<port_format>.<port_index>.<signal_type>.<index><CR> FEEDBACK ~nn@EDID-AUDIO_<audio_format><CR><LF>	The following attributes comprise the signal ID: ▪ <direction_type> – Direction of the port: o IN – Input o OUT – Output ▪ <port_format> – Type of signal on the port: o HDMI o ANALOG_AUDIO o USB_C ▪ <port_index> – The port number as printed on the front or rear panel ▪ <signal_type> – Signal ID attribute: o AUDIO ▪ <index> – Indicates a specific channel number when there are multiple channels of the same type audio_format – Audio block added to EDID: 0 – Auto 1 – LPCM 2CH 2 – LPCM 6CH 3 – LPCM 8CH 4 – Bitstream 5 – HD	Get HDMI IN 2 audio capabilities for EDID: #EDID-AUDIO?_in.hdmi.2.audio.1,2<CR>
EDID-DC	Force removal of deep color on EDID or leaving it as in the original EDID.	COMMAND #EDID-DC_<in_index>,deep_color_state<CR> FEEDBACK ~nn@EDID-DC_<in_index>,deep_color_state<CR><LF>	in_index – Number that indicates the specific input: 1 – Input 1 2 – Input 2 deep_color_state – 0 – Don't change 1 – Remove deep color	Remove deep color on EDID for input 1. #EDID-DC_1,1<CR>

Function	Description	Syntax	Parameters/Attributes	Example
EDID-DC?	Get deep color status on EDID.	COMMAND #EDID-DC?_in_index <CR> FEEDBACK ~nn@EDID-DC_in_index,deep_color_state<CR><LF>	in_index – Number that indicates the specific input: 1 – Input 1 2 – Input 2 deep_color_state – 0 – Don't change 1 – Remove deep color	Get deep color state on EDID for input 2. #EDID-DC?_2<CR>
ETH-PORT	Set Ethernet port protocol. ⓘ If the port number you enter is already in use, an error is returned. The port number must be within the following range: 0-(2 ¹⁶ -1).	COMMAND #ETH-PORT_port_type,port_id<CR> FEEDBACK ~nn@ETH-PORT_port_type,port_id<CR><LF>	port_type – TCP/UDP port_id – TCP/UDP port number (0 – 65535)	Set the Ethernet port protocol for TCP to 12457: #ETH-PORT_TCP,12457<CR>
ETH-PORT?	Get Ethernet port protocol. ⓘ If the port number you enter is already in use, an error is returned. The port number must be within the following range: 0-(2 ¹⁶ -1).	COMMAND #ETH-PORT?_port_type<CR> FEEDBACK ~nn@ETH-PORT?_port_type,port_id<CR><LF>	port_type – TCP/UDP port_id – TCP/UDP port number (0 – 65535)	Get the Ethernet port protocol for UDP: #ETH-PORT?_UDP<CR>
ETH-TUNNEL?	Get an open tunnel parameters.	COMMAND #ETH-TUNNEL?_tunnel_id<CR> FEEDBACK ~nn@ETH-TUNNEL_tunnel_id,cmd_name,port_type,port_id,eth_ip,remote_port_id,eth_rep_en,connection_type<CR><LF>	tunnel_id – Tunnel ID number, * (get all open tunnels) cmd_name – UART number port_type – TCP/UDP 0 – TCP 1 – UDP port_id – TCP/UDP port number eth_ip – Client IP address remote_port_id – Remote port number eth_rep_en – Ethernet Reply 0 – COM port does not send replies to new clients 1 – COM port sends replies to new clients connection_type – Connection type 0 – not wired connection 1 – wired connection	Set baud rate to 9600, 8 data bits, parity to none and stop bit to 1: #ETH-TUNNEL?*<CR>
FACTORY	Reset device to factory default configuration. ⓘ This command deletes all user data from the device. The deletion can take some time. Your device may require powering off and powering on for the changes to take effect.	COMMAND #FACTORY<CR> FEEDBACK ~nn@FACTORY_ok<CR><LF>		Reset the device to factory default configuration: #FACTORY<CR>
FW-TYPE?	Get the current FW type status. Used by Kramer Network and KUpload to identify recovery process.	COMMAND #FW-TYPE?_<CR> FEEDBACK ~nn@FEATURE-LIST_fw_type<CR><LF>	Fw_type – 0 – Application 1 – Safe mode (kboot)	Get the current FW type status: #FW-TYPE?_<CR>
GLOBAL-GW-ACTIVE	Set global gateway to active / inactive.	COMMAND #GLOBAL-GW-ACTIVE_status<CR> FEEDBACK ~nn@GLOBAL-GW-ACTIVE_status<CR><LF>	status – On/Off ON – Active Off – Inactive	Set global gateway off: #AUDIO-BYPASS_OFF<CR>
GLOBAL-GW-ACTIVE?	Set global gateway to active / inactive.	COMMAND #GLOBAL-GW-ACTIVE?<CR> FEEDBACK ~nn@GLOBAL-GW-ACTIVE_status<CR><LF>	status – On/Off ON – Active Off – Inactive	Get global gateway off: #AUDIO-BYPASS?<CR>
GPIO-CFG	Set HW GPIO configuration.	COMMAND #GPIO-CFG_gpio_id,gpio_type,gpio_dir,pullup<CR> FEEDBACK ~nn@GPIO-CFG_gpio_id,gpio_type,gpio_dir<CR><LF>	gpio_id – Hardware GPIO number (1-2) gpio_type – Hardware GPIO type 0 – analog 1 – digital gpio_dir – Hardware GPIO direction 0 – input 1 – output pullup – Enable/Disable pull-up 0 – disable 1 – enable	Set HW GPIO 1 configuration: #GPIO-CFG_1,1,1,1<CR>
GPIO-CFG?	Get HW GPIO configuration.	COMMAND #GPIO-CFG?_gpio_id<CR> FEEDBACK ~nn@GPIO-CFG_gpio_id,gpio_type,gpio_dir<CR><LF>	gpio_id – Hardware GPIO number (1-2) gpio_type – Hardware GPIO type 0 – analog 1 – digital gpio_dir – Hardware GPIO direction 0 – input 1 – output pullup – Enable/Disable pull-up 0 – disable 1 – enable	Get HW GPIO configuration: #GPIO-CFG?_1<CR>

Function	Description	Syntax	Parameters/Attributes	Example
GPIO-STATE	<p>Set HW GPIO state.</p> <p>i GPIO-STATE? can only be set in digital out mode and the answer is 0=Low, 1=High. In all other modes an error message is sent.</p> <p>The device uses this command to notify the user of any change regarding the step and voltage in:</p> <p>In digital mode the answer is 0 (low), 1 (high).</p> <p>In analog mode the answer is 0 to 100.</p>	<p>COMMAND</p> <pre>#GPIO-STATE_{gpio_id,gpio_mode}<CR></pre> <p>FEEDBACK</p> <pre>~nn@GPIO-STATE_{gpio_id,gpio_mode}<CR><LF></pre>	<p>gpio_id – Hardware GPIO number (1-2)</p> <p>gpio_mode – Hardware GPIO state 0 – Low 1 – High</p>	<p>Set GPIO 2 to High: #GPIO-STATE_2,1<CR></p>
GPIO-STATE?	<p>Get HW GPIO state.</p> <p>i GPIO-STATE? can only be set in digital out mode and the answer is 0=Low, 1=High. In all other modes an error message is sent.</p> <p>The device uses this command to notify the user of any change regarding the step and voltage in:</p> <p>In digital mode the answer is 0 (low), 1 (high).</p> <p>In analog mode the answer is 0 to 100.</p>	<p>COMMAND</p> <pre>#GPIO-STATE?_{gpio_id}<CR></pre> <p>FEEDBACK</p> <pre>~nn@GPIO-STATE_{gpio_id,gpio_mode}<CR><LF></pre>	<p>gpio_id – Hardware GPIO number (1-2)</p> <p>gpio_mode – Hardware GPIO state 0 – Low 1 – High</p>	<p>Get GPIO 2 state: #GPIO-STATE?_2<CR></p>
GPIO-STEP	<p>Set HW GPIO step.</p> <p>i In digital mode the response is 2.</p> <p>In analog mode the response is 1 to 100.</p> <p>In other modes an error is returned.</p>	<p>COMMAND</p> <pre>#GPIO-STEP_{gpio_id,step_id}<CR></pre> <p>FEEDBACK</p> <pre>~nn@GPIO-STEP_{gpio_id,step_id,currentstep}<CR><LF></pre>	<p>gpio_id – HW GPIO number (1-2)</p> <p>step_id – The configuration step – See note in description.</p> <p>currentstep – The actual step depending on the measured voltage</p>	<p>Set GPIO 2 (set to Analog In) configuration step to 38mV: #GPIO-STEP_2,38<CR></p>
GPIO-STEP?	<p>Get HW GPIO step.</p> <p>i In digital mode the response is 2.</p> <p>In analog mode the response is 1 to 100.</p> <p>In other modes an error is returned.</p>	<p>COMMAND</p> <pre>#GPIO-STEP?_{gpio_id}<CR></pre> <p>FEEDBACK</p> <pre>~nn@GPIO-STEP_{gpio_id,step_id,currentstep}<CR><LF></pre>	<p>gpio_id – HW GPIO number (1-2)</p> <p>step_id – The configuration step – See note in description.</p> <p>currentstep – The actual step depending on the measured voltage</p>	<p>Get GPIO 2configuration: #GPIO-STEP?_2<CR></p>
GPIO-THR	<p>Set HW GPIO voltage levels.</p>	<p>COMMAND</p> <pre>#GPIO-THR_{gpio_id,low_level,high_level}<CR></pre> <p>FEEDBACK</p> <pre>~nn@GPIO-THR_{gpio_id,low_level,high_level}<CR><LF></pre>	<p>gpio_id – Hardware GPIO number (1-2)</p> <p>low_level – Voltage 500 to 28000 millivolts</p> <p>high_level – Voltage 2000 to 30000 millivolts</p>	<p>Set GPIO 2 to a low level of 800mV and a high level of 2200mV: #GPIO-THR_2,800,2200<CR></p>
GPIO-THR?	<p>Get HW GPIO voltage levels that were set.</p>	<p>COMMAND</p> <pre>#GPIO-THR?_{gpio_id}<CR></pre> <p>FEEDBACK</p> <pre>~nn@GPIO-THR_{gpio_id,low_level,high_level}<CR><LF></pre>	<p>gpio_id – Hardware GPIO number (1-2)</p> <p>low_level – Voltage 500 to 28000 millivolts</p> <p>high_level – Voltage 2000 to 30000 millivolts</p>	<p>Get GPIO 2: #GPIO-THR?_2<CR></p>
GPIO-VOLT?	<p>Get active voltage levels of HW GPIO.</p> <p>i This command is not available in digital out mode.</p>	<p>COMMAND</p> <pre>GPIO-VOLT?_{gpio_id}<CR></pre> <p>FEEDBACK</p> <pre>~nn@GPIO-VOLT_{gpio_id,voltage}<CR><LF></pre>	<p>gpio_id – Hardware GPIO number (1-2)</p> <p>voltage – Voltage 0 to 30000 millivolts</p>	<p>Get GPIO 1 voltage: #GPIO-VOLT?_1<CR></p>
HDCP-MOD	<p>Set HDCP mode.</p> <p>i Get HDCP working mode on the device input:</p> <p>HDCP supported – HDCP ON [default].</p> <p>HDCP not supported - HDCP OFF.</p> <p>HDCP support changes following detected sink - MIRROR OUTPUT.</p>	<p>COMMAND</p> <pre>#HDCP-MOD_{in_index,mode}<CR></pre> <p>FEEDBACK</p> <pre>~nn@HDCP-MOD_{in_index,mode}<CR><LF></pre>	<p>in_index – Number that indicates the specific input: 1 – USB-C IN 2 – HDMI IN</p> <p>mode – HDCP mode: 0 – HDCP Off 1 – HDCP On 2 – Follow Input 3 – HDCP defined according to the connected output</p>	<p>Set the input HDCP-MODE of HDMI IN to off: #HDCP-MOD_2,0<CR></p>







Function	Description	Syntax	Parameters/Attributes	Example
HDCP-MOD?	<p>Get HDCP mode.</p> <p>ⓘ Get HDCP working mode on the device input:</p> <p>HDCP supported – HDCP ON [default].</p> <p>HDCP not supported - HDCP OFF.</p> <p>HDCP support changes following detected sink - MIRROR OUTPUT.</p>	<p>COMMAND</p> <pre>#HDCP-MOD?_in_index<CR></pre> <p>FEEDBACK</p> <pre>~nn@HDCP-MOD_in_index,mode<CR><LF></pre>	<p>in_index – Number that indicates the specific input:</p> <p>1 – USB-C IN</p> <p>2 – HDMI IN</p> <p>mode – HDCP mode:</p> <p>0 – HDCP Off</p> <p>1 – HDCP On</p> <p>2 – Follow Input</p> <p>3 – HDCP defined according to the connected output</p>	<p>Get the input HDCP-MODE of HDMI IN :</p> <pre>#HDCP-MOD?_2<CR></pre>
HDCP-OUT	<p>Set output port HDCP mode.</p> <p>HDCP supported – HDCP ON [default].</p> <p>HDCP not supported - HDCP OFF.</p> <p>HDCP support changes following detected sink - MIRROR OUTPUT.</p>	<p>COMMAND</p> <pre>#HDCP-OUT_port number,mode<CR></pre> <p>FEEDBACK</p> <pre>~nn@HDCP-OUT_port number,mode<CR><LF></pre>	<p>Port number – output port number:</p> <p>1 – N</p> <p>mode – HDCP mode:</p> <p>0 – Follow Input</p> <p>1 – Follow Output</p>	<p>Set the output port 1 HDCP follow output:</p> <pre>#HDCP-OUT_1,1<CR></pre>
HDCP-OUT?	<p>Get output HDCP mode.</p> <p>ⓘ Get HDCP working mode on the device input:</p> <p>HDCP supported – HDCP ON [default].</p> <p>HDCP not supported - HDCP OFF.</p> <p>HDCP support changes following detected sink - MIRROR OUTPUT.</p>	<p>COMMAND</p> <pre>#HDCP-OUT?_port number,mode<CR></pre> <p>FEEDBACK</p> <pre>~nn@HDCP-OUT_port number<CR><LF></pre>	<p>Port number – output port number:</p> <p>1 – N</p>	<p>Get HDCP mode for output port 1:</p> <pre>#HDCP-OUT?_1<CR></pre>
HDCP-STAT?	<p>Get HDCP signal status of a connected device.</p> <p>ⓘ io_mode =1 – get the HDCP signal status of the sink device connected to the specified output.</p> <p>io_mode =0 – get the HDCP signal status of the source device connected to the specified input.</p>	<p>COMMAND</p> <pre>#HDCP-STAT?_io_mode,in_index<CR></pre> <p>FEEDBACK</p> <pre>~nn@HDCP-STAT_io_mode,in_index,status<CR><LF></pre>	<p>io_mode – Input/Output</p> <p>0 – Input</p> <p>1 – Output</p> <p>io_index – Number that indicates the specific number of inputs or outputs (based on io_mode):</p> <p>1 – HDBaseT OUT or USB-C IN</p> <p>2 – HDMI IN</p> <p>status – Signal encryption status - valid values On/Off:</p> <p>0 – HDCP Off</p> <p>1 – HDCP On</p>	<p>Get the HDCP status of the source device connected to USB-C IN:</p> <pre>#HDCP-STAT?_0,1<CR></pre>
HELP	<p>Get command list or help for specific command.</p>	<p>COMMAND</p> <pre>#HELP<CR></pre> <pre>#HELP_cmd_name<CR></pre> <p>FEEDBACK</p> <p>1. Multi-line:</p> <pre>~nn@Device_cmd_name,_cmd_name...<CR><LF></pre> <p>To get help for command use: HELP (COMMAND_NAME)<CR><LF></p> <pre>~nn@HELP_cmd_name:<CR><LF></pre> <pre>description<CR><LF></pre> <pre>USAGE : usage<CR><LF></pre>	<p>cmd_name – Name of a specific command</p>	<p>Get the command list:</p> <pre>#HELP<CR></pre> <p>To get help for AV-SW-TIMEOUT:</p> <pre>HELP_av-sw-timeout<CR></pre>
IDV	<p>Set visual indication from device.</p> <p>ⓘ Using this command, some devices can light a sequence of buttons or LEDs to allow identification of a specific device from similar devices.</p>	<p>COMMAND</p> <pre>#IDV<CR></pre> <p>FEEDBACK</p> <pre>~nn@IDV_ok<CR><LF></pre>		<pre>#IDV<CR></pre>
IR-MOD	<p>Set the IR modulation</p>	<p>COMMAND</p> <pre>#IR-MOD?_port modulation<CR></pre> <p>FEEDBACK</p> <pre>~nn@IR-MOD_<CR><LF></pre>	<p>Port – port number</p> <p>1</p> <p>Modulation –</p> <p>0 – no modulation</p> <p>1 – 38K</p>	<p>Set IR modulation to 38k:</p> <pre>#IR-MOD_1,1<CR></pre>
IR-MOD?	<p>Get the IR modulation</p>	<p>COMMAND</p> <pre>#IR-MOD_port<CR></pre> <p>FEEDBACK</p> <pre>~nn@IR-MOD_<CR><LF></pre>	<p>Port – port number</p> <p>1</p> <p>Modulation –</p> <p>0 – no modulation</p> <p>1 – 38K</p>	<p>Get the IR modulation:</p> <pre>#IR-MOD?_1<CR></pre>

Function	Description	Syntax	Parameters/Attributes	Example
LOCK-EDID?	Get EDID Lock status.	COMMAND #LOCK-EDID?_in_index <CR> FEEDBACK ~nn@LOCK-EDID_in_index,lock_mode<CR><LF>	in_index – Number that indicates the specific input: 1 – USB-C IN 2 – HDMI IN lock_mode – On/Off 0 – Off unlocks EDID 1 – On locks EDID	Get input 2 Lock EDID status: #LOCK-EDID?_2<CR>
LOG-TAIL?	Get the list of the N last events.	COMMAND #LOG-TAIL?_last_event<CR> FEEDBACK ~nn@LOG-TAIL_last_event,ok,<list><CR><LF>	last_event – the number of last events to view <N = 1,2,3...>	Get the protocol permission level to Admin: #LOG-TAIL?_8<CR>
LOGIN	Set protocol permission. ⓘ The permission system works only if security is enabled with the "SECUR" command. LOGIN allows the user to run commands with an End User or Administrator permission level. When the permission system is enabled, LOGIN enables running commands with the User or Administrator permission level. When set, login must be performed upon each connection. It is not mandatory to enable the permission system in order to use the device. In each device, some connections allow logging in to different levels. Some do not work with security at all. Connection may logout after timeout.	COMMAND #LOGIN_login_level,password<CR> FEEDBACK ~nn@LOGIN_login_level,password_ok<CR><LF> or ~nn@LOGIN_err_004<CR><LF> (if bad password entered)	login_level – Level of permissions required (User or Admin) password – Predefined password (by PASS command). Default password is an empty string	Set the protocol permission level to Admin (when the password defined in the PASS command is 33333): #LOGIN_admin,33333<CR>>
LOGIN?	Get protocol permission state. ⓘ The permission system works only if security is enabled with the "SECUR" command. LOGIN allows the user to run commands with an End User or Administrator permission level. When the permission system is enabled, LOGIN enables running commands with the User or Administrator permission level. When set, login must be performed upon each connection. It is not mandatory to enable the permission system in order to use the device. In each device, some connections allow logging in to different levels. Some do not work with security at all. Connection may logout after timeout.	COMMAND #LOGIN_login_level <CR> FEEDBACK ~nn@LOGIN_login_level,password_ok<CR><LF> or ~nn@LOGIN_err_004<CR><LF> (if bad password entered)	login_level – Level of permissions required (User or Admin) password – Predefined password (by PASS command). Default password is an empty string or NO SECURE if authentication is removed.	Get the protocol permission level to Admin: #LOGIN?_admin<CR>
LOGOUT	Cancel current permission level. ⓘ Logs out from End User or Administrator permission levels to Not Secure.	COMMAND #LOGOUT<CR> FEEDBACK ~nn@LOGOUT_ok<CR><LF>		#LOGOUT<CR>
MODEL?	Get device model.	COMMAND #MODEL?_<CR> FEEDBACK ~nn@MODEL_model_name<CR><LF>	model_name – String of up to 19 printable ASCII chars	Get the device model: #MODEL?_<CR>

Function	Description	Syntax	Parameters/Attributes	Example
NAME	<p>Set machine (DNS) name.</p> <p>i The machine name is not the same as the model name. The machine name is used to identify a specific machine or a network in use (with DNS feature on).</p>	<p>COMMAND</p> <pre>#NAME _machine_name<CR></pre> <p>FEEDBACK</p> <pre>~nn@NAME _machine_name<CR><LF></pre>	<p>machine_name – String of up to 15 alpha-numeric chars (can include hyphen, not at the beginning or end)</p>	<p>Set the DNS name of the device to room-442:</p> <pre>#NAME _room-442<CR></pre>
NAME?	<p>Get machine (DNS) name.</p> <p>i The machine name is not the same as the model name. The machine name is used to identify a specific machine or a network in use (with DNS feature on).</p>	<p>COMMAND</p> <pre>#NAME? _<CR></pre> <p>FEEDBACK</p> <pre>~nn@NAME _machine_name<CR><LF></pre>	<p>machine_name – String of up to 15 alpha-numeric chars (can include hyphen, not at the beginning or end)</p>	<p>Get the DNS name of the device:</p> <pre>#NAME? _<CR></pre>
NAME-RST	<p>Reset machine (DNS) name to factory default.</p> <p>i Factory default of machine (DNS) name is "KRAMER_" + 4 last digits of device serial number.</p>	<p>COMMAND</p> <pre>#NAME-RST<CR></pre> <p>FEEDBACK</p> <pre>~nn@NAME-RST _ok<CR><LF></pre>		<p>Reset the machine name (S/N last digits are 0102):</p> <pre>#NAME-RST _kramer_0102<CR></pre>
NET-CONFIG	<p>Set a network configuration.</p> <p>i Parameters [DNS1] and [DNS2] are optional.</p> <p>i For Backward compatibility, the id parameter can be omitted. In this case, the Network ID, by default, is 0, which is the Ethernet control port.</p> <p>i If the gateway address is not compliant to the subnet mask used for the host IP, the command will return an error. Subnet and gateway compliancy specified by RFC950.</p>	<p>COMMAND</p> <pre>#NET-CONFIG _netw_id,net_ip,net_mask,gateway,[dns1],[dns2]<CR></pre> <p>FEEDBACK</p> <pre>~nn@NET-CONFIG _netw_id,net_ip,net_mask,gateway<CR><LF></pre>	<p>netw_id – 0</p> <p>net_ip – Network IP</p> <p>net_mask – Network mask</p> <p>gateway – Network gateway</p>	<p>Set the device network parameters to IP address 192.168.113.10, net mask 255.255.0.0, and gateway 192.168.0.1:</p> <pre>#NET-CONFIG _0,192.168.113.10,255.255.0.0,192.168.0.1<CR></pre>
NET-CONFIG?	<p>Get a network configuration.</p> <p>i Parameters [DNS1] and [DNS2] are optional.</p> <p>i For Backward compatibility, the id parameter can be omitted. In this case, the Network ID, by default, is 0, which is the Ethernet control port.</p> <p>i If the gateway address is not compliant to the subnet mask used for the host IP, the command will return an error. Subnet and gateway compliancy specified by RFC950.</p>	<p>COMMAND</p> <pre>#NET-CONFIG _netw_id,net_ip,net_mask,gateway,[dns1],[dns2]<CR></pre> <p>FEEDBACK</p> <pre>~nn@NET-CONFIG _netw_id,net_ip,net_mask,gateway<CR><LF></pre>	<p>netw_id – 0</p> <p>net_ip – Network IP</p> <p>net_mask – Network mask</p> <p>gateway – Network gateway</p>	<p>Get the device network parameters:</p> <pre>#NET-CONFIG? _0<CR></pre>
NET-DHCP?	<p>Get DHCP mode.</p> <p>i For Backward compatibility, the id parameter can be omitted. In this case, the Network ID, by default, is 0, which is the Ethernet control port.</p>	<p>COMMAND</p> <pre>#NET-DHCP? _netw_id<CR></pre> <p>FEEDBACK</p> <pre>~nn@NET-DHCP _netw_id,dhcp_state<CR><LF></pre>	<p>netw_id – Network ID—the device network interface (if there are more than one). Counting is 0 based, meaning the control port is '0', additional ports are 1,2,3....</p> <p>dhcp_state –</p> <ul style="list-style-type: none"> 0 – Do not use DHCP. Use the IP set by the factory or using the net-ip or net-config command. 1 – Try to use DHCP. If unavailable, use the IP set by the factory or using the net-ip or net-config command. 	<p>Get DHCP mode for port 1:</p> <pre>#NET-DHCP? _1<CR></pre>

Function	Description	Syntax	Parameters/Attributes	Example
NET-GATE	Set gateway IP. ⓘ A network gateway connects the device via another network and maybe over the Internet. Be careful of security issues. For proper settings consult your network administrator.	COMMAND #NET-GATE_ ip_address<CR> FEEDBACK ~nn@NET-GATE_ ip_address<CR><LF>	ip_address – Format: xxx.xxx.xxx.xxx	Set the gateway IP address to 192.168.0.1: #NET-GATE_192.168.000.001<CR>
NET-GATE?	Get gateway IP. ⓘ A network gateway connects the device via another network and maybe over the Internet. Be aware of security problems.	COMMAND #NET-GATE?_<CR> FEEDBACK ~nn@NET-GATE_ ip_address<CR><LF>	ip_address – Format: xxx.xxx.xxx.xxx	Get the gateway IP address: #NET-GATE?_<CR>
NET-IP	Set IP address. ⓘ For proper settings consult your network administrator.	COMMAND #NET-IP_ ip_address<CR> FEEDBACK ~nn@NET-IP_ ip_address<CR><LF>	ip_address – Format: xxx.xxx.xxx.xxx	Set the IP address to 192.168.1.39: #NET-IP_192.168.001.039<CR>
NET-IP?	Get IP address.	COMMAND #NET-IP?_<CR> FEEDBACK ~nn@NET-IP_ ip_address<CR><LF>	ip_address – Format: xxx.xxx.xxx.xxx	Get the IP address: #NET-IP?_<CR>
NET-MAC?	Get MAC address. ⓘ For backward compatibility, the id parameter can be omitted. In this case, the Network ID, by default, is 0, which is the Ethernet control port.	COMMAND #NET-MAC?_ id<CR> FEEDBACK ~nn@NET-MAC_ id, mac_address<CR><LF>	id – Network ID—the device network interface (if there are more than one). Counting is 0 based, meaning the control port is '0', additional ports are 1,2,3.... mac_address – Unique MAC address. Format: XX-XX-XX-XX-XX-XX where X is hex digit	#NET-MAC?_ id<CR>
NET-MASK	Set subnet mask. ⓘ For proper settings consult your network administrator.	COMMAND #NET-MASK_ net_mask<CR> FEEDBACK ~nn@NET-MASK_ net_mask<CR><LF>	net_mask – Format: xxx.xxx.xxx.xxx	Set the subnet mask to 255.255.0.0: #NET-MASK_255.255.000.000<CR>
NET-MASK?	Get subnet mask.	COMMAND #NET-MASK?_<CR> FEEDBACK ~nn@NET-MASK_ net_mask<CR><LF>	net_mask – Format: xxx.xxx.xxx.xxx	Get the subnet mask: #NET-MASK?_<CR>
PASS	Set password for login level. ⓘ The default password is an empty string.	COMMAND #PASS_ login_level, password<CR> FEEDBACK ~nn@PASS_ login_level, password<CR><LF>	login_level – Level of login to set (End User or Administrator). password – Password for the login_level. Up to 15 printable ASCII chars	Set the password for the Admin protocol permission level to 33333: #PASS_ admin, 33333<CR>
PASS?	Get password for login level. ⓘ The default password is an empty string.	COMMAND #PASS_ login_level <CR> FEEDBACK ~nn@PASS_ login_level, password<CR><LF>	login_level – Level of login to set (End User or Administrator). password – Password for the login_level. Up to 15 printable ASCII chars	Get the password for the Admin protocol permission: #PASS?_ admin<CR>
PORTS-LIST?	Get the port list of this machine. ⓘ The response is returned in one line and terminated with<CR><LF>. The response format lists port IDs separated by commas. This is an Extended Protocol 3000 command.	COMMAND #PORTS-LIST?_<CR> FEEDBACK ~nn@PORTS-LIST_ [<direction_type>.<port_format>.<port_index>,...]<CR><LF>	The following attributes comprise the port ID: ▪ <direction_type> – Direction of the port: ○ IN ○ OUT ▪ <port_format> – Type of signal on the port: ○ HDMI ○ USB_C ▪ <port_index> – The port number as printed on the front or rear panel	Get the ports list: #PORTS-LIST?_<CR>
PRG-ACTION	Add new user command. ⓘ Programs matrix action as a response for external event (programmable button pressed).	COMMAND #PRG-ACTION_ commandNum, type, name, command<CR> FEEDBACK ~nn@PRG-ACTION_ commandNum, type, name, command<CR><LF>	commandNum – Command number 0 to 4 type – External programmable button 0 – CEC 1 – UART 2 – IR name – Bitmap representing command – External programmable button ID	Add a new user command: #PRG-ACTION_1, 3, 1, 0<CR>
PRG-ACTION?	Add new user command. ⓘ Programs matrix action as a response for external event (programmable button pressed).	COMMAND #PRG-ACTION?_ commandNum<CR> FEEDBACK ~nn@PRG-ACTION_ commandNum, type, name, command<CR><LF>	commandNum – Command number 0 – Input 1 – Output type – External programmable button ID name – Bitmap representing command – External programmable button ID	Add a new user command: #PRG-ACTION?_0, 3, 1, 0<CR>

Function	Description	Syntax	Parameters/Attributes	Example
PRG-BTN-ACTION	Set device's programmable button, link to commands On & Off, and set command to momentary or not momentary.	COMMAND #PRG-BTN- MOD_btnNum,mode,actionOn,actionOff,btnBehavior<CR> FEEDBACK ~nn@PRG-BTN- MOD_btnNum,mode,actionOn,actionOff,btnBehavior<CR><LF> >	btnNum – Button number 0 to 4 1 and 2 are enabled when remote button is (mode) On 1 – IO 1 button 2 – IO 2 button 3 – Display On button mode – Remote button state 0 – Off 1 – On actionOn – 100 – None 101 – Switch Input 102 – Display On (via CEC) 103 – Display Off (via CEC) 104 – Mute 105 – Unmute 106 – Volume ++ 107 – Volume -- 0 – Command_01 1 – Command_02 2 – Command_03 3 – Command_04 4 – Custom 5 actionOff – Button_mode 100 – None 101 – Switch Input 102 – Display On (via CEC) 103 – Display Off (via CEC) 104 – Mute 105 – Unmute 106 – Volume ++ 107 – Volume -- 0 – Command_01 1 – Command_02 2 – Command_03 3 – Command_04 4 – Custom 5 btnBehavior – Button_mode 0 – Momentary mode disabled 1 – Momentary mode enabled	Set the DISPLAY ON button to mute/unmute with the press of a button: #PRG-BTN- MOD_3,1,104,105,0<CR>
PRG-BTN-MOD?	Get device's programmable button, link to commands On & Off, and set command to momentary or not momentary.	COMMAND #PRG-BTN-MOD?<CR> FEEDBACK ~nn@PRG-BTN-MOD_button_mode<CR><LF>	btnNum – Button number 0 to 4 1 and 2 are enabled when remote button is (mode) On 1 – IO 1 button 2 – IO 2 button 3 – Display On button mode – Remote button state 0 – Off 1 – On actionOn – 100 – None 101 – Switch Input 102 – Display On (via CEC) 103 – Display Off (via CEC) 104 – Mute 105 – Unmute 106 – Volume ++ 107 – Volume -- 0 – Command_01 1 – Command_02 2 – Command_03 3 – Command_04 4 – Custom 5 actionOff – Button_mode 100 – None 101 – Switch Input 102 – Display On (via CEC) 103 – Display Off (via CEC) 104 – Mute 105 – Unmute 106 – Volume ++ 107 – Volume -- 0 – Command_01 1 – Command_02 2 – Command_03 3 – Command_04 4 – Custom 5 btnBehavior – Button_mode 0 – Momentary mode disabled 1 – Momentary mode enabled	Get the mode of button 3: #PRG-BTN-MOD?_3<CR>
PRIORITY	Set input priority.	COMMAND #PRIORITY_layer_type,priority_1,priority_2,priority_3<CR> FEEDBACK ~nn@PRIORITY_layer_type,priority_1,priority_2,priority_3<CR><LF>	layer_type – Layer Enumeration 1 – Video priority – Priority of inputs (1-2) 1 – USB-C 1 2 – HDMI 2 3 – HDMI 3	Set the priority to first HDMI 2, USB-C 1 second and HDMI 3 third: #PRIORITY_1,2,1,3<CR>

Function	Description	Syntax	Parameters/Attributes	Example
PRIORITY?	Set input priority.	COMMAND #PRIORITY?_layer_type<CR> FEEDBACK ~nn@PRIORITY_layer_type,priority_1,priority_2,priority_3<CR><LF>	layer_type – Layer Enumeration 1 – Video priority – Priority of inputs (1-2) 1 – USB-C 1 2 – HDMI 2 3 – HDMI 3	Get the input priority: #PRIORITY?_1<CR>
PROT-VER?	Get device protocol version.	COMMAND #PROT-VER?_<CR> FEEDBACK ~nn@PROT-VER_3000:version<CR><LF>	version – XX.XX where X is a decimal digit	Get the device protocol version: #PROT-VER?_<CR>
RESET	Reset device.  To avoid locking the port due to a USB bug in Windows, disconnect USB connections immediately after running this command. If the port was locked, disconnect, and reconnect the cable to reopen the port.	COMMAND #RESET<CR> FEEDBACK ~nn@RESET_ok<CR><LF>		Reset the device: #RESET<CR>
ROUTE	Set layer routing.  This command replaces all other routing commands.	COMMAND #ROUTE_layer_type,out_index,in_index<CR> FEEDBACK ~nn@ROUTE_layer_type,out_index,in_index<CR><LF>	layer_type Layer Enumeration 1 – Video 5 – USB out_index 1 – Output in_index – Source id for Video: 1 – USB-C 1 2 – HDMI IN 2 3 – HDMI IN 3	Route video input 2 to the output: #ROUTE_1,1,2<CR>
ROUTE?	Get layer routing state.  This command replaces all other routing commands.	COMMAND #ROUTE?_layer_type,out_index<CR> FEEDBACK ~nn@ROUTE_layer_type,out_index,in_index <CR><LF>	layer_type Layer Enumeration 1 – Video 5 – USB out_index 1 – Output in_index – Source id for Video: 1 – USB-C 1 2 – HDMI IN 2 3 – HDMI IN 3	Get video routing output: #ROUTE?_1,1<CR>
SECUR	Start/stop security.  The permission system works only if security is enabled with the "SECUR" command.	COMMAND #SECUR_security_state<CR> FEEDBACK ~nn@SECUR_security_state<CR><LF>	security_state – Security state 0 – OFF (disables security) 1 – ON (enables security)	Enable the permission system: #SECUR_1<CR>
SECUR?	Get security state.  The permission system works only if security is enabled with the "SECUR" command.	COMMAND #SECUR?_security_state<CR> FEEDBACK ~nn@SECUR_security_state<CR><LF>	security_state – Security state 0 – OFF (disables security) 1 – ON (enables security)	Enable the permission system: #SECUR?_<CR>
SIGNAL?	Get input signal status.	COMMAND #SIGNAL?_in_index<CR> FEEDBACK ~nn@SIGNAL_in_index,status<CR><LF>	in_index – Number that indicates the specific input: 1 – USB-C IN 1 2 – HDMI IN 2 3 – HDMI IN 3 status – Signal status according to signal validation: 0 – Off 1 – On	Get the input signal lock status of IN 1: #SIGNAL?_1<CR>
SN?	Get device serial number.	COMMAND #SN?_<CR> FEEDBACK ~nn@SN_serial_num<CR><LF>	serial_num – 14 decimal digits, factory assigned	Get the device serial number: #SN?_<CR>
TIME	Set device time and date.  The year must be 4 digits. The device does not validate the day of week from the date. Time format - 24 hours. Date format - Day, Month, Year.	COMMAND #TIME_day_of_week,date,data<CR> FEEDBACK ~nn@TIME_day_of_week,date,data<CR><LF>	day_of_week – One of (SUN,MON,TUE,WED,THU,FRI,SAT) date – Format: DD-MM-YYYY. data – Format: hh:mm:ss where hh = hours mm = minutes ss = seconds	Set device time and date to December 5, 2020 at 2:30pm: #TIME_mon_05-12-2020,14:30:00<CR>

Function	Description	Syntax	Parameters/Attributes	Example
TIME?	<p>Get device time and date.</p> <p>i The year must be 4 digits.</p> <p>The device does not validate the day of week from the date.</p> <p>Time format - 24 hours.</p> <p>Date format - Day, Month, Year.</p>	<p>COMMAND</p> <p>#TIME?_<CR></p> <p>FEEDBACK</p> <p>~nn@TIME,_day_of_week,date,data<CR><LF></p>	<p>day_of_week – One of {SUN,MON,TUE,WED,THU,FRI,SAT}</p> <p>date – Format: YYYY/MM/DD where YYYY = Year MM = Month DD = Day</p> <p>data – Format: hh:mm:ss where hh = hours mm = minutes ss = seconds</p>	<p>Get device time and date: #TIME?<CR></p>
TIME-LOC	<p>Set local time offset from UTC/GMT.</p> <p>i If the time server is configured, device time calculates by adding UTC_off to UTC time (that it got from the time server) + 1 hour if daylight savings time is in effect.</p> <p>TIME command sets the device time without considering these settings.</p>	<p>COMMAND</p> <p>#TIME-LOC,_utc_off,dst_state<CR></p> <p>FEEDBACK</p> <p>~nn@TIME-LOC,_utc_off,dst_state<CR><LF></p>	<p>utc_off – Offset of device time from UTC/GMT (without daylight time correction)</p> <p>dst_state – Daylight saving time state 0 – no daylight saving time 1 – daylight saving time</p>	<p>Set local time offset to 3 with no daylight-saving time: #TIME-LOC_3,0<CR></p>
TIME-LOC?	<p>Get local time offset from UTC/GMT.</p> <p>i If the time server is configured, device time calculates by adding UTC_off to UTC time (that it got from the time server) + 1 hour if daylight savings time is in effect.</p> <p>TIME command sets the device time without considering these settings.</p>	<p>COMMAND</p> <p>#TIME-LOC?_<CR></p> <p>FEEDBACK</p> <p>~nn@TIME-LOC,_utc_off,dst_state<CR><LF></p>	<p>utc_off – Offset of device time from UTC/GMT (without daylight time correction)</p> <p>dst_state – Daylight saving time state 0 – no daylight saving time 1 – daylight saving time</p>	<p>Get local time offset from UTC/GMT: #TIME-LOC?<CR></p>
TIME-SRV	<p>Set time server.</p> <p>i This command is needed for setting UDP timeout for the current client list.</p>	<p>COMMAND</p> <p>#TIME-SRV,_mode,time_server_ip,sync_hour<CR></p> <p>FEEDBACK</p> <p>~nn@TIME-SRV,_mode,time_server_ip,server_status,server_sync_time,<CR><LF></p>	<p>mode – On/Off 0 – Off 1 – On</p> <p>time_server_ip – Time server IP address</p> <p>sync_hour – Hour in day for time server sync</p> <p>server_status – On/Off</p>	<p>Set time server with IP address of 128.138.140.44 to ON: #TIME-SRV_1,128.138.140.44,0,1<CR></p>
TIME-SRV?	<p>Get time server.</p> <p>i This command is needed for setting UDP timeout for the current client list.</p>	<p>COMMAND</p> <p>#TIME-SRV?_<CR></p> <p>FEEDBACK</p> <p>~nn@TIME-SRV,_mode,time_server_ip,server_status,server_sync_time,<CR><LF></p>	<p>mode – On/Off 0 – Off 1 – On</p> <p>time_server_ip – Time server IP address</p> <p>sync_hour – Hour in day for time server sync</p> <p>server_status – On/Off</p>	<p>Get time server: #TIME-SRV?<CR></p>
TXRX-MODE	<p>Set tx/rx mode.</p> <p>i This command will reset the device and restore factory defaults.</p>	<p>COMMAND</p> <p>#TXRX-MODE,_hdbt_port_id,hdbt_mode<CR></p> <p>FEEDBACK</p> <p>~nn@TXRX-MODE,_hdbt_port_id,hdbt_mode<CR><LF></p>	<p>hdbt_port_id: HDBT port number</p> <p>hdbt_mode: HDBT mode 0-Transmitter 1-Receiver</p>	<p>Set device in Transmitter mode</p> <p>#TXRX-MODE_1,0<CR></p>
UART	<p>Set com port configuration.</p> <p>i In the FC-2x the serial port is selectable to RS-232 or RS-485 (usually serial port 1).</p> <p>If Serial is configured when RS-485 is selected, the RS-485 UART port automatically changes.</p> <p>The command is backward compatible, meaning that if the extra parameters do not exist, FW goes to RS-232.</p> <p>Stop_bits 1.5 is only relevant for 5 data bits.</p>	<p>COMMAND</p> <p>#UART,_com_id,baud_rate,data_bits,parity,stop_bits_mode,serial_type,485_term<CR></p> <p>FEEDBACK</p> <p>~nn@UART,_com_id,baud_rate,data_bits,parity,stop_bits_mode,serial_type,485_term<CR><LF></p>	<p>com_id – 1 to n (machine dependent)</p> <p>baud_rate – 9600 - 115200</p> <p>data_bits – 5-8</p> <p>parity – Parity Type 0 – No 1 – Odd 2 – Even 3 – Mark 4 – Space</p> <p>stop_bits_mode – 1/1.5/2</p> <p>serial_type – 232/485 0 – 232 1 – 485</p> <p>485_term – 485 termination state 0 – disable 1 – enable (optional - this exists only when serial_type is 485)</p>	<p>Set baud rate to 9600, 8 data bits, parity to none and stop bit to 1: #UART_9600,8,node,1<CR></p>

Function	Description	Syntax	Parameters/Attributes	Example
UART?	Get com port configuration. The command is backward compatible, meaning that if the extra parameters do not exist, FW goes to RS-232. Stop_bits 1.5 is only relevant for 5 data_bits.	COMMAND #UART?_com_id<CR> FEEDBACK ~nn@UART_com_id,baud_rate,data_bits,parity,stop_bits_mode,serial_type,485_term<CR><LF>	com_id – 1 to n (machine dependent) baud_rate – 9600 - 115200 data_bits – 5-8 parity – Parity Type 0 – No 1 – Odd 2 – Even 3 – Mark 4 – Space stop_bits_mode – 1/1.5/2 serial_type – 232/485 0 – 232 1 – 485 485_term – 485 termination state 0 – disable 1 – enable (optional - this exists only when serial_type is 485)	Set baud rate to 9600, 8 data bits, parity to none and stop bit to 1: #UART_1,9600,8,node,1<CR>
UART-SWITCH		COMMAND #UART-SWITCH_<CR> FEEDBACK ~nn@UART-SWITCH<CR><LF>		
UART-SWITCH?		COMMAND #UART-SWITCH?_<CR> FEEDBACK ~nn@UART-SWITCH<CR><LF>		
USBC-ETH	Set USBC to Ethernet connection.	COMMAND #USBC-ETH_state<CR> FEEDBACK ~nn@USBC-ETH_state<CR><LF>	state – On/Off 0 – Off 1 – On	Set USBC to Ethernet connection state to ON: #USBC-ETH_1<CR>
USB-FV	Set USB auto-switching mode.	COMMAND #USB-FV_mode<CR> FEEDBACK ~nn@USB-FV_mode<CR><LF>	mode – On/Off 0 – Off 1 – On	Set auto-switching mode to ON: #USB-FV_1<CR>
USB-FV?	Get USB auto-switching mode.	COMMAND #USB-FV?_mode<CR> FEEDBACK ~nn@USB-FV_mode<CR><LF>	mode – On/Off 0 – Off 1 – On	Set auto-switching mode to ON: #USB-FV_1<CR>
USBA-DISCONNECT-MODE	Set USB device auto-disconnection mode..	COMMAND #USBA-DISCONNECT-MODE_USBDevice,mode<CR> FEEDBACK ~nn@USBA-DISCONNECT-MODE_mode<CR><LF>	USBDevice – USB device number 1 – USB Device 1 2 – USB Device 2 3 – USB Device 3 4 – USB Device 4 mode – On/Off 0 – Off 1 – On	Set USB Device 1 polycorm mode to ON: #USBA-DISCONNECT-MODE_1,1<CR>
USBA-DISCONNECT-MODE?	Get USB device auto-disconnection mode..	COMMAND #USBA-DISCONNECT-MODE?_USBDevice<CR> FEEDBACK ~nn@USBA-DISCONNECT-MODE_mode<CR><LF>	USBDevice – USB device number 1 – USB Device 1 2 – USB Device 2 3 – USB Device 3 4 – USB Device 4 mode – On/Off 0 – Off 1 – On	Get USB Device 1 polycorm mode: #USBA-DISCONNECT-MODE?_1<CR>
VERSION?	Get firmware version number.	COMMAND #VERSION?_<CR> FEEDBACK ~nn@VERSION_firmware_version<CR><LF>	firmware_version – XX.XX.XXXX where the digit groups are: major.minor.build version	Get the device firmware version number: #VERSION?_<CR>
VMUTE	Set enable/disable video on output. ⓘ Video mute parameter 2 (blank picture) is not supported.	COMMAND #VMUTE_out_index,flag<CR> FEEDBACK ~nn@VMUTE_out_index,flag<CR><LF>	out_index – Number that indicates the specific output – 1 flag – Video Mute 0 – Video enabled 1 – Video disabled 2 – Blank picture	Disable the video output on output: #VMUTE_1,0<CR>
VMUTE?	Get video on output status. ⓘ Video mute parameter 2 (blank picture) is not supported.	COMMAND #VMUTE?_out_index<CR> FEEDBACK ~nn@VMUTE_out_index,flag<CR><LF>	out_index – Number that indicates the specific output – 1 flag – Video Mute 0 – Video enabled 1 – Video disabled 2 – Blank picture	Get video on output status: #VMUTE?_1<CR>

Result and Error Codes

Syntax

In case of an error, the device responds with an error message. The error message syntax:

- **~NN@ERR XXX<CR><LF>** – when general error, no specific command
- **~NN@CMD ERR XXX<CR><LF>** – for specific command
- **NN** – machine number of device, default = 01
- **XXX** – error code

Error Codes

Error Name	Error Code	Description
P3K_NO_ERROR	0	No error
ERR_PROTOCOL_SYNTAX	1	Protocol syntax
ERR_COMMAND_NOT_AVAILABLE	2	Command not available
ERR_PARAMETER_OUT_OF_RANGE	3	Parameter out of range
ERR_UNAUTHORIZED_ACCESS	4	Unauthorized access
ERR_INTERNAL_FW_ERROR	5	Internal FW error
ERR_BUSY	6	Protocol busy
ERR_WRONG_CRC	7	Wrong CRC
ERR_TIMEDOUT	8	Timeout
ERR_RESERVED	9	(Reserved)
ERR_FW_NOT_ENOUGH_SPACE	10	Not enough space for data (firmware, FPGA...)
ERR_FS_NOT_ENOUGH_SPACE	11	Not enough space – file system
ERR_FS_FILE_NOT_EXISTS	12	File does not exist
ERR_FS_FILE_CANT_CREATED	13	File can't be created
ERR_FS_FILE_CANT_OPEN	14	File can't open
ERR_FEATURE_NOT_SUPPORTED	15	Feature is not supported
ERR_RESERVED_2	16	(Reserved)
ERR_RESERVED_3	17	(Reserved)
ERR_RESERVED_4	18	(Reserved)
ERR_RESERVED_5	19	(Reserved)
ERR_RESERVED_6	20	(Reserved)
ERR_PACKET_CRC	21	Packet CRC error
ERR_PACKET_MISSED	22	Packet number isn't expected (missing packet)
ERR_PACKET_SIZE	23	Packet size is wrong
ERR_RESERVED_7	24	(Reserved)
ERR_RESERVED_8	25	(Reserved)
ERR_RESERVED_9	26	(Reserved)
ERR_RESERVED_10	27	(Reserved)
ERR_RESERVED_11	28	(Reserved)
ERR_RESERVED_12	29	(Reserved)
ERR_EDID_CORRUPTED	30	EDID corrupted
ERR_NON_LISTED	31	Device specific errors
ERR_SAME_CRC	32	File has the same CRC – not changed
ERR_WRONG_MODE	33	Wrong operation mode
ERR_NOT_CONFIGURED	34	Device/chip was not initialized

The warranty obligations of Kramer Electronics Inc. ("Kramer Electronics") for this product are limited to the terms set forth below:

What is Covered

This limited warranty covers defects in materials and workmanship in this product.

What is Not Covered

This limited warranty does not cover any damage, deterioration or malfunction resulting from any alteration, modification, improper or unreasonable use or maintenance, misuse, abuse, accident, neglect, exposure to excess moisture, fire, improper packing and shipping (such claims must be presented to the carrier), lightning, power surges, or other acts of nature. This limited warranty does not cover any damage, deterioration or malfunction resulting from the installation or removal of this product from any installation, any unauthorized tampering with this product, any repairs attempted by anyone unauthorized by Kramer Electronics to make such repairs, or any other cause which does not relate directly to a defect in materials and/or workmanship of this product. This limited warranty does not cover cartons, equipment enclosures, cables or accessories used in conjunction with this product.

Without limiting any other exclusion herein, Kramer Electronics does not warrant that the product covered hereby, including, without limitation, the technology and/or integrated circuit(s) included in the product, will not become obsolete or that such items are or will remain compatible with any other product or technology with which the product may be used.

How Long this Coverage Lasts

The standard limited warranty for Kramer products is seven (7) years from the date of original purchase, with the following exceptions:

1. All Kramer VIA hardware products are covered by a standard three (3) year warranty for the VIA hardware and a standard three (3) year warranty for firmware and software updates; all Kramer VIA accessories, adapters, tags, and dongles are covered by a standard one (1) year warranty.
2. Kramer fiber optic cables, adapter-size fiber optic extenders, pluggable optical modules, active cables, cable retractors, ring mounted adapters, portable power chargers, Kramer speakers, and Kramer touch panels are covered by a standard one (1) year warranty. Kramer 7-inch touch panels purchased on or after April 1st, 2020 are covered by a standard two (2) year warranty.
3. All Kramer Calibre products, all Kramer Minicom digital signage products, all HighSecLabs products, all streaming, and all wireless products are covered by a standard three (3) year warranty.
4. All Sierra Video MultiViewers are covered by a standard five (5) year warranty.
5. Sierra switchers & control panels are covered by a standard seven (7) year warranty (excluding power supplies and fans that are covered for three (3) years).
6. K-Touch software is covered by a standard one (1) year warranty for software updates.
7. All Kramer passive cables are covered by a lifetime warranty.

Who is Covered

Only the original purchaser of this product is covered under this limited warranty. This limited warranty is not transferable to subsequent purchasers or owners of this product.

What Kramer Electronics Will Do

Kramer Electronics will, at its sole option, provide one of the following three remedies to whatever extent it shall deem necessary to satisfy a proper claim under this limited warranty:

1. Elect to repair or facilitate the repair of any defective parts within a reasonable period of time, free of any charge for the necessary parts and labor to complete the repair and restore this product to its proper operating condition. Kramer Electronics will also pay the shipping costs necessary to return this product once the repair is complete.
2. Replace this product with a direct replacement or with a similar product deemed by Kramer Electronics to perform substantially the same function as the original product. If a direct or similar replacement product is supplied, the original product's end warranty date remains unchanged and is transferred to the replacement product.
3. Issue a refund of the original purchase price less depreciation to be determined based on the age of the product at the time remedy is sought under this limited warranty.

What Kramer Electronics Will Not Do Under This Limited Warranty

If this product is returned to Kramer Electronics or the authorized dealer from which it was purchased or any other party authorized to repair Kramer Electronics products, this product must be insured during shipment, with the insurance and shipping charges prepaid by you. If this product is returned uninsured, you assume all risks of loss or damage during shipment. Kramer Electronics will not be responsible for any costs related to the removal or re-installation of this product from or into any installation. Kramer Electronics will not be responsible for any costs related to any setting up this product, any adjustment of user controls or any programming required for a specific installation of this product.

How to Obtain a Remedy Under This Limited Warranty

To obtain a remedy under this limited warranty, you must contact either the authorized Kramer Electronics reseller from whom you purchased this product or the Kramer Electronics office nearest you. For a list of authorized Kramer Electronics resellers and/or Kramer Electronics authorized service providers, visit our web site at www.kramerav.com or contact the Kramer Electronics office nearest you.

In order to pursue any remedy under this limited warranty, you must possess an original, dated receipt as proof of purchase from an authorized Kramer Electronics reseller. If this product is returned under this limited warranty, a return authorization number, obtained from Kramer Electronics, will be required (RMA number). You may also be directed to an authorized reseller or a person authorized by Kramer Electronics to repair the product.

If it is decided that this product should be returned directly to Kramer Electronics, this product should be properly packed, preferably in the original carton, for shipping. Cartons not bearing a return authorization number will be refused.

Limitation of Liability

THE MAXIMUM LIABILITY OF KRAMER ELECTRONICS UNDER THIS LIMITED WARRANTY SHALL NOT EXCEED THE ACTUAL PURCHASE PRICE PAID FOR THE PRODUCT. TO THE MAXIMUM EXTENT PERMITTED BY LAW, KRAMER ELECTRONICS IS NOT RESPONSIBLE FOR DIRECT, SPECIAL, INCIDENTAL OR CONSEQUENTIAL DAMAGES RESULTING FROM ANY BREACH OF WARRANTY OR CONDITION, OR UNDER ANY OTHER LEGAL THEORY. Some countries, districts or states do not allow the exclusion or limitation of relief, special, incidental, consequential or indirect damages, or the limitation of liability to specified amounts, so the above limitations or exclusions may not apply to you.

Exclusive Remedy

TO THE MAXIMUM EXTENT PERMITTED BY LAW, THIS LIMITED WARRANTY AND THE REMEDIES SET FORTH ABOVE ARE EXCLUSIVE AND IN LIEU OF ALL OTHER WARRANTIES, REMEDIES AND CONDITIONS, WHETHER ORAL OR WRITTEN, EXPRESS OR IMPLIED. TO THE MAXIMUM EXTENT PERMITTED BY LAW, KRAMER ELECTRONICS SPECIFICALLY DISCLAIMS ANY AND ALL IMPLIED WARRANTIES, INCLUDING, WITHOUT LIMITATION, WARRANTIES OF MERCHANTABILITY AND FITNESS FOR A PARTICULAR PURPOSE. IF KRAMER ELECTRONICS CANNOT LAWFULLY DISCLAIM OR EXCLUDE IMPLIED WARRANTIES UNDER APPLICABLE LAW, THEN ALL IMPLIED WARRANTIES COVERING THIS PRODUCT, INCLUDING WARRANTIES OF MERCHANTABILITY AND FITNESS FOR A PARTICULAR PURPOSE, SHALL APPLY TO THIS PRODUCT AS PROVIDED UNDER APPLICABLE LAW. IF ANY PRODUCT TO WHICH THIS LIMITED WARRANTY APPLIES IS A "CONSUMER PRODUCT" UNDER THE MAGNUSON-MOSS WARRANTY ACT (15 U.S.C.A. §2301, ET SEQ.) OR OTHER APPLICABLE LAW, THE FOREGOING DISCLAIMER OF IMPLIED WARRANTIES SHALL NOT APPLY TO YOU, AND ALL IMPLIED WARRANTIES ON THIS PRODUCT, INCLUDING WARRANTIES OF MERCHANTABILITY AND FITNESS FOR THE PARTICULAR PURPOSE, SHALL APPLY AS PROVIDED UNDER APPLICABLE LAW.

Other Conditions

This limited warranty gives you specific legal rights, and you may have other rights which vary from country to country or state to state.

This limited warranty is void if (i) the label bearing the serial number of this product has been removed or defaced, (ii) the product is not distributed by Kramer Electronics or (iii) this product is not purchased from an authorized Kramer Electronics reseller. If you are unsure whether a reseller is an authorized Kramer Electronics reseller, visit our web site at www.kramerav.com or contact a Kramer Electronics office from the list at the end of this document.

Your rights under this limited warranty are not diminished if you do not complete and return the product registration form or complete and submit the online product registration form. Kramer Electronics thanks you for purchasing a Kramer Electronics product. We hope it will give you years of satisfaction.



HDMI™
HIGH-DEFINITION MULTIMEDIA INTERFACE



P/N: 2900-301703

Rev: 3



SAFETY WARNING

Disconnect the unit from the power supply before opening and servicing

For the latest information on our products and a list of Kramer distributors, visit our website where updates to this user manual may be found.

We welcome your questions, comments, and feedback.

The terms HDMI, HDMI High-Definition Multimedia Interface, and the HDMI Logo are trademarks or registered trademarks of HDMI Licensing Administrator, Inc. All brand names, product names, and trademarks are the property of their respective owners.