

All images in this datasheet are for illustrative purposes only.

Video Wall VSH7J

0.44mm Even Bezel Video Wall

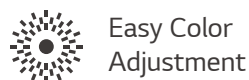

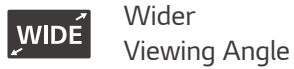
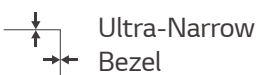
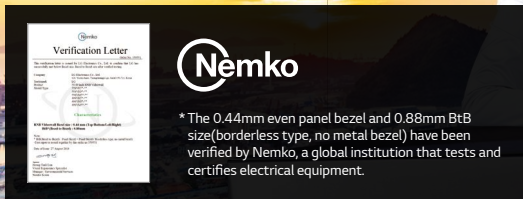
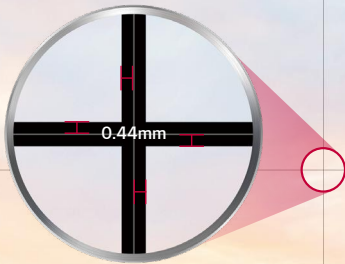

Nemko

* The 0.44mm even panel bezel and 0.88mm BtB size (borderless type, no metal bezel) have been verified by Nemko, a global institution that tests and certifies electrical equipment.



Groundbreaking 0.44mm Even Bezel

The unprecedented razor-thin bezel – 0.44 mm EVEN BEZEL and 0.88 mm BEZEL TO BEZEL – which has been verified by Nemko*, makes content look like the actual original image by depicting a subject perfectly true to form, without any distortions. Seamlessly assembled on a large video wall screen, the VSH7J series will provide an even more immersive experience to viewers.

VIVID AND DYNAMIC PICTURE QUALITY

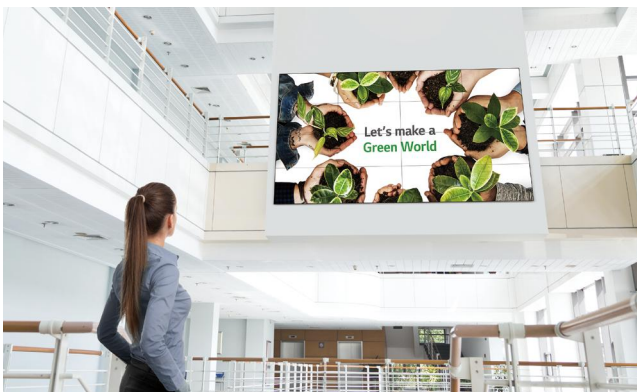

60** High Viewing Angle

Higher Viewing Angle

Large screens are usually positioned higher than human-eye level, making uniform picture quality essential for video walls. The viewing angle of the VSH7J series is high enough to display vivid colors throughout the screen with no distortion.

* Results based on in-house testing. Actual test results may differ depending on environment and measuring equipment.

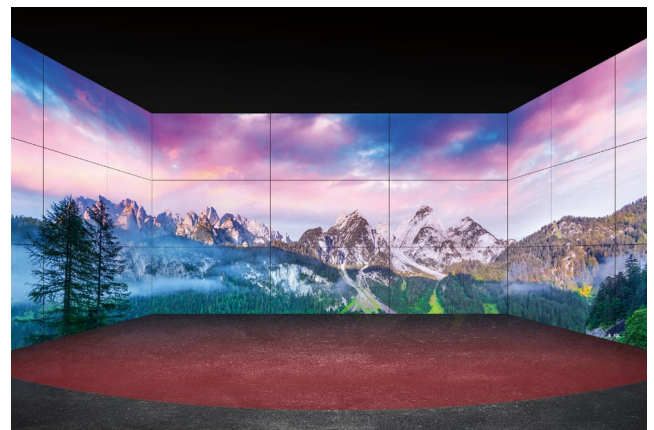

Wide Viewing Angle

It is well known that LG IPS panel technology enables better control of liquid crystals, which in turn allows the screen to be viewed from virtually any angle. Because of this, the VSH7J series captures the attention of and captivates more viewers with lifelike colors, regardless of their viewing position.

* All images are intended to help you understand, and there may be some differences in practical use.

VIVID AND DYNAMIC PICTURE QUALITY

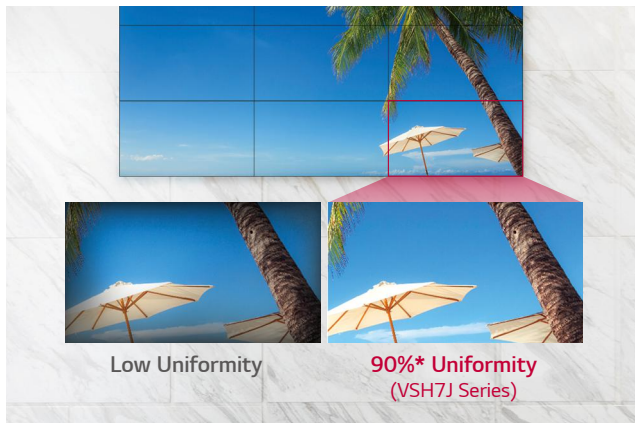

Uniform Color Expression

Poor uniformity around bezel boundaries can give the corners a darker appearance, which doesn't look good on a large screen. However, the VSH7J series has enhanced uniformity, even within the four corners of the display, to deliver vivid and consistent color throughout the screen.

* Uniformity among 13 points of the screen. Results based on in-house testing. Actual test results may differ depending on environment and measuring equipment.

Image Gap Reduction

The VSH7J series includes an image improvement algorithm that can reduce image gaps among tiled displays when playing back videos. Objects located on the bezel boundaries are adjusted for a seamless viewing experience.

* The "55SVH7F series" refers to displays which do not include an image improvement algorithm.

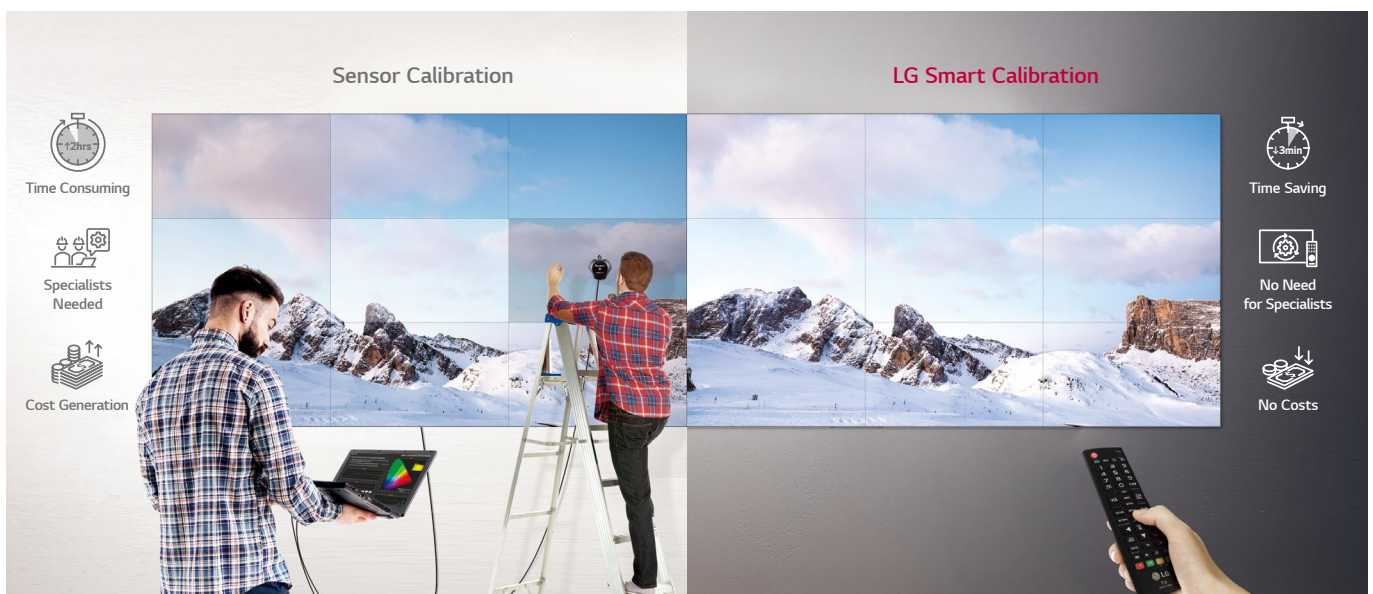

Smart Calibration

Smart Calibration is a solution that enables the reduction of time and costs compared to existing sensor calibration methods. It analyzes not only the color property differences within each individual display but also the differences between connected displays. With just few simple clicks of a remote control, this calibration process can be done in a matter of minutes. In addition, calibration can be set to automatically occur at regular intervals to always deliver optimum image quality.

* Depending on the user, the difference in color can be felt after smart calibration. In this case, it is recommended to adjust the color manually.

* All images are intended to help you understand, and there may be some differences in practical use.

VIVID AND DYNAMIC PICTURE QUALITY



Clear View with Non-glare Panel

Viewers can be annoyed by unnecessary light reflection when watching a screen under bright conditions. The VSH7J series has resolved such inconveniences by increasing the level of haze to 28%, which enhanced visibility and text readability.

POWERFUL SMART SIGNAGE PLATFORM



High Performance and Great Scalability

Thanks to its built-in SoC and webOS smart signage platform, the VSH7J series can execute several tasks at once while providing smooth content playback without the need for a media player. As webOS supports HTML5 as a web-based platform and offers SDK (Software Development Kit), it is even easier for SIs to build and optimize their web apps.

* SDK can be downloaded with the link below.
(<https://webossignage.developer.lge.com>)

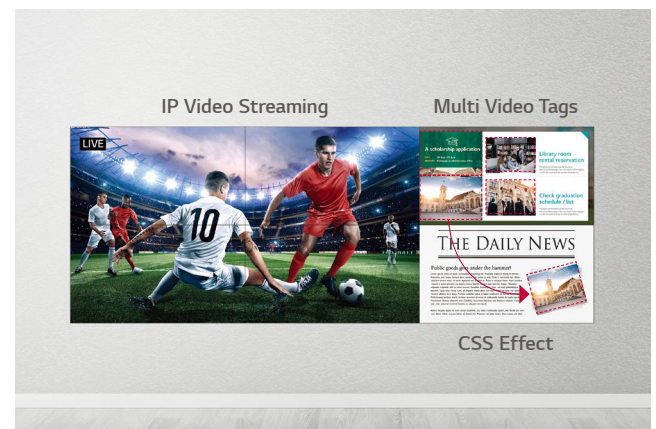

Flexible Content Creation

Four different videos can be played simultaneously via web apps, and various animation effects, such as scaling or rotating, are added to content using CSS (Cascading Style Sheets) transition effects. Real-time streaming* is also available, providing the flexibility to organize and diversify content free from capacity limits.

* Supported protocols : RTSP, RTP, HLS, UDP Multicast

* All images are intended to help you understand, and there may be some differences in practical use.

USER-FRIENDLY SMART SIGNAGE UX

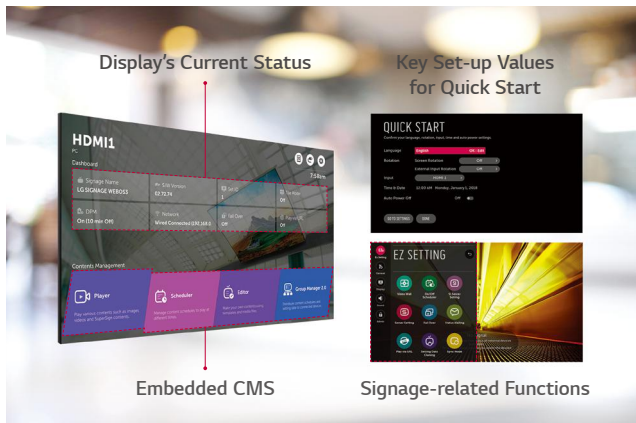

Intuitive Menu Structure

The menu structure has been optimized for commercial use. It simplifies approach flows and groups similar functions together, adopting a more intuitive GUI for ease of use. This way, users can avoid having to do trial-and-error when exploring desired functions and managing displays.

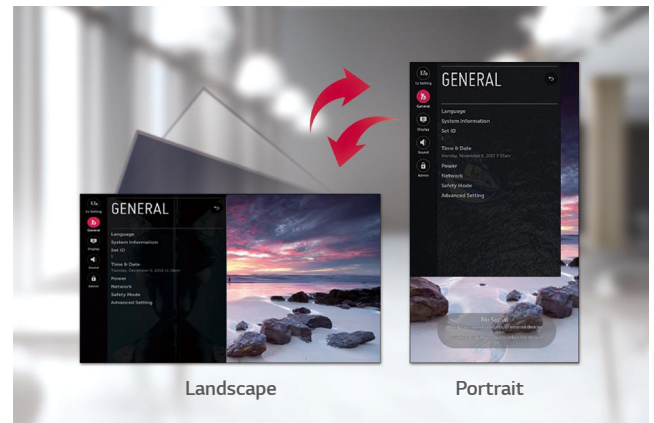

Dedicated GUI for Portrait Orientation

The conventional GUI (Graphic User Interface) was designed based on landscape-oriented consumer TV usage, so OSD (On Screen Display) wasn't well-suited for screens in portrait mode. The OSD of the VSH7J series, however, consists of a long range menu with bigger font sizes and a 9:16 ratio, creating a comfortable and efficient business environment.

USER CONVENIENCE

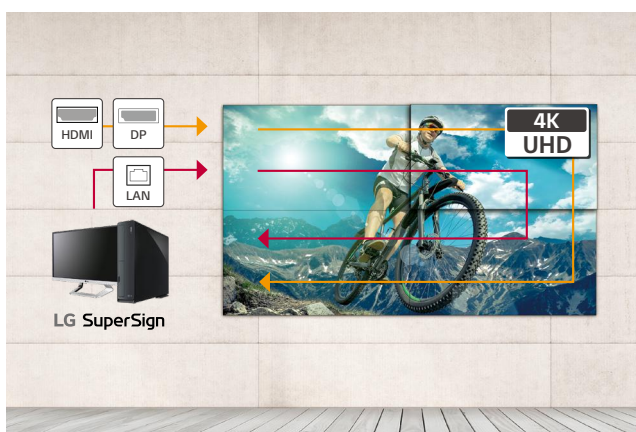

Daisy Chain Capability

A LAN daisy chain allows you to control and monitor video walls and even update their firmwares at once. Also, through UHD daisy chain using HDMI and DisplayPort, you can easily set up a UHD video wall without the need of DisplayPort MST or Matrox graphics card.



Real-Time LG ConnectedCare

Maintenance is easy and fast with the optional LG ConnectedCare* service, a cloud service solution provided by LG. It remotely manages the status of displays in client workplaces for fault diagnosis and remote-control services, enabling the stable operation of clients' businesses.

* LG ConnectedCare is the brand name of LG Signage365Care Service. The availability differs by region.

* All images are intended to help you understand, and there may be some differences in practical use.

PRODUCT INFORMATION

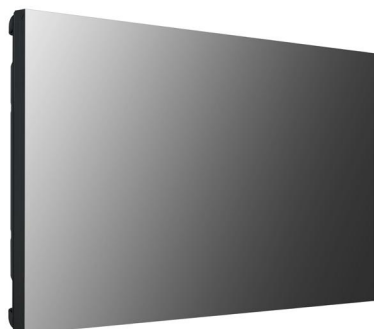

VSH7J

Screen Size	55"
Aspect Ratio	16 : 9
Native Resolution	FHD (1,920 × 1,080)
Brightness	700 nit (Typ.)
Contrast Ratio	1,100 : 1

DIMENSION

(unit: mm)

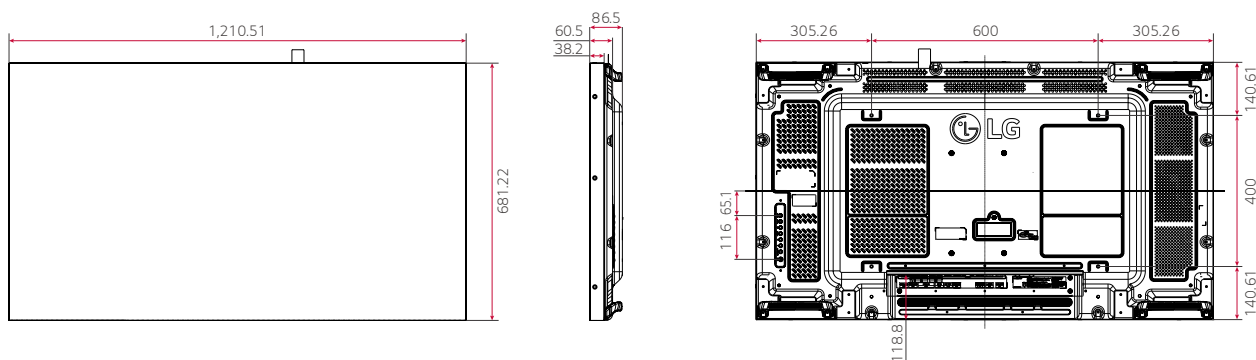

CONNECTIVITY

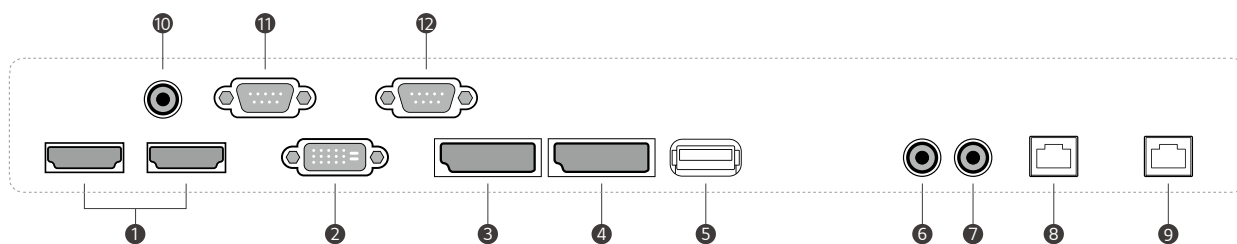

- ① HDMI IN
- ② DVI-D IN
- ③ DP IN
- ④ DP OUT
- ⑤ USB 2.0 IN
- ⑥ AUDIO IN
- ⑦ AUDIO OUT
- ⑧ LAN IN
- ⑨ LAN OUT
- ⑩ IR IN
- ⑪ RS-232C IN
- ⑫ RS-232C OUT

* Dimensions & Jack Panels may differ from the above image, so please contact LG sales team to verify before ordering.



Download
LG C-Display+
Mobile App
Google Play Store

- www.lg.com/global/business/information-display
- www.youtube.com/c/LGCommercialDisplay
- www.facebook.com/LGInformationDisplay
- www.linkedin.com/company/lginformationdisplay
- twitter.com/LG_ID_HQ

LG may make changes to specifications and product descriptions without notice. Copyright © 2022 LG Electronics Inc. All rights reserved. "LG Life's Good" is a registered trademark of LG Corp. The names of products and brands mentioned here may be the trademarks of their respective owners.

