

330.2 mm

330.2 mm

482.6 mm

482.6 mm

Targus User Guide

ASP95GL | ASP95MKGLX

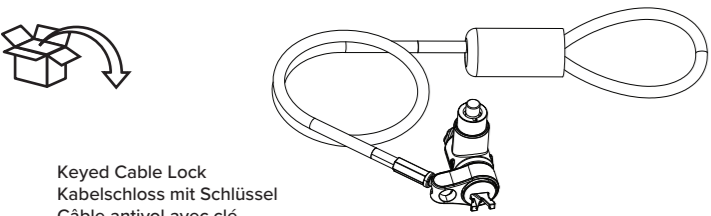

Keyed Cable Lock
Kabelschloss mit Schlüssel
Câble antivol avec clé
Lucchetto a chiave con chiave
Kabelslot met sleutel
Cadeado com cabo e chave
Anahitir Kablo Kilidi
Candado con llave y cable de seguridad
Замок с триском и ключом

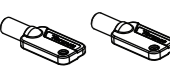

Keys
Schlüssel
Clés
Chiași
Sleutels
Chaves
Anahitirler
Llaves
Ключи

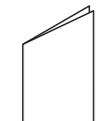

User Guide
Benutzerhandbuch
Guia del usuario
Guide de l'utilisateur
Guida utente
Gebruikershandleiding
Manual do Utilizador
Кullanıcı kılavuzu
Руководство по эксплуатации

Lock the Device

Gerät sperren | Bloquer el dispositivo | Verrouiller l'appareil | Bloccare il dispositivo | Het apparaat vergrendelen | Prender o dispositivo | Chizi Kilitleyin | Блокировать устройство

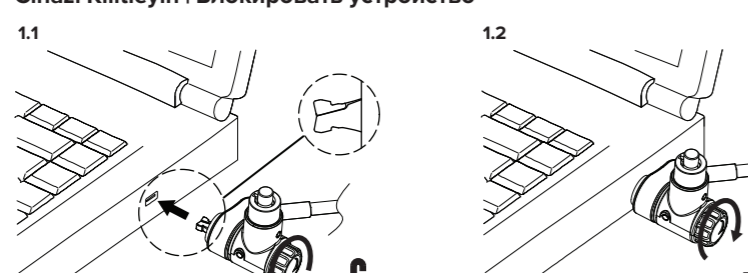

Before any operation, ensure covers is closed fully and clockwise. Insert the key into the slot. Turn the key clockwise to lock the device. The cover will close automatically.

Unlock the Device

Gerät entsperren | Desbloquer el dispositivo | Déverrouiller l'appareil | Sbloccare il dispositivo | Het apparaat ontgrendelen | Desprender o dispositivo | Kilitliyi Açın | Разблокировать устройство

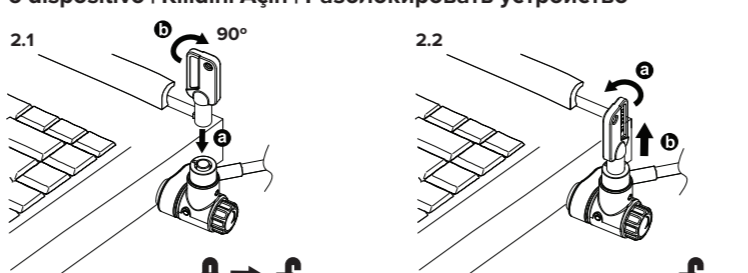

Insert the key, turn the key 90° clockwise to unlock. Turn the cover clockwise to open. The cover will open automatically.

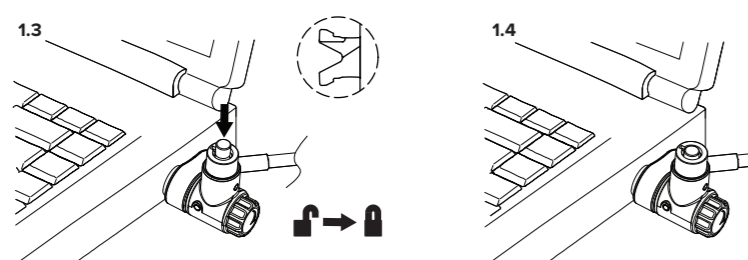

Push the button to lock the device. Make sure the button is fully depressed. Press the button again to unlock the device.

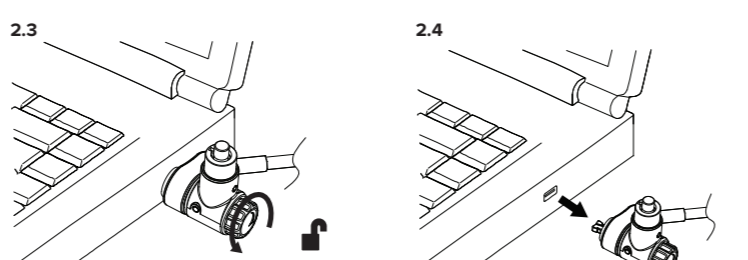

Rotate the cover anti-clockwise to lock. Turn the key clockwise to unlock. Turn the cover clockwise to open.

Attach the Foam Spacer

Befestigen Sie die Schutzpolsterung | Fija el separador de espuma | Installez l'espacer en mousse | Collegare il distanziatore in schiuma | Bevestig de afstandhouder van schuim | Fijar o Espaciador de Espuma | Köpük Ara Parçasını Takın | Прикрепите прокладку из пеноматериала

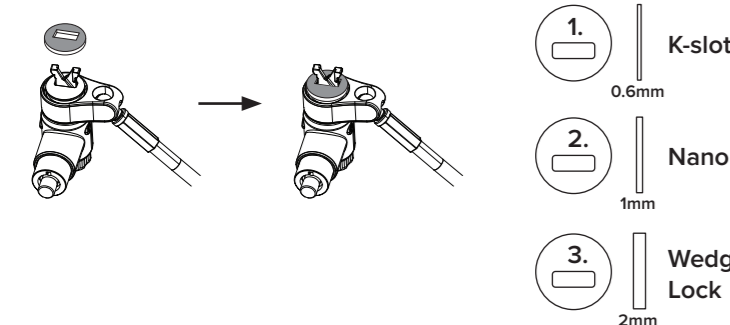

OPTION A: Secure with the Anchor (Sold Separately)

OPTION A: Mit der Verankerung sichern (Separat erhältlich) | OPCIÓN A: Asegurar a la base (Vendida por separado) | OPTION A : fixer avec l'ancrage (Vendue séparément) | OPZIONE A: Fissaggio con ancoraggio (Venduta separatamente) | OPTIE A: Bevestigen met het anker(apat verkrijgbaar) | OPCÃO A: fixar com a base de ancoragem (vendida separadamente) | SEÇENEK A: Ankorita Sabitlemek (Ayrı Satılır) | ВАРИАНТ А: фиксация при помощи крепления (продается отдельно)

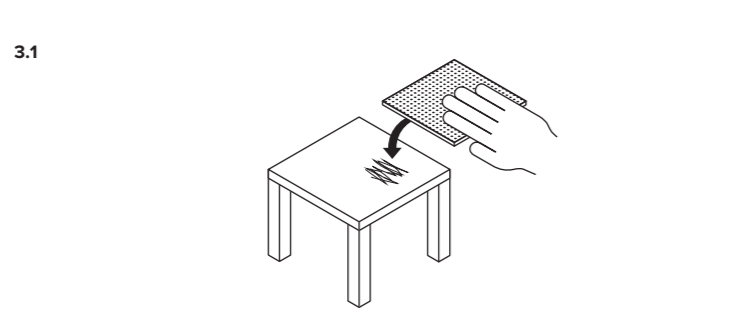

DEFCON Security BasePlate - PA400P (Sold Separately)

DEFCON Sicherungsplatte - PA400P (Separat erhältlich) | Placa de soporte de seguridad DEFCON - PA400P (Vendida por separado) | Plaque de base de sécurité DEFCON - PA400P (Vendue séparément) | Plastro base di sicurezza DEFCON - PA400P (Venduta separatamente) | DEFCON basisplaat - PA400P (separat verkrijgbaar) | Placa base de segurança DEFCON - PA400P (vendida separadamente) | DEFCON Güvenlik Taban Plakası - PA400P (Ayrı Satılır) | Опорная плата безопасности DEFCON - PA400P (продается отдельно)



OPTION B: Securing Without Anchor

OPTION B: Ohne Verankerung sichern | OPCIÓN B: Asegurar sin la base | OPTION B : fixer sans l'ancrage | OPZIONE B: Fissaggio senza ancoraggio | OPTIE B: Bevestigen zonder anker | OPCÃO B: fixar sem a base de ancoragem | SEÇENEK B: Ankorusuz Sabitlemek | ВАРИАНТ Б: фиксация без крепления

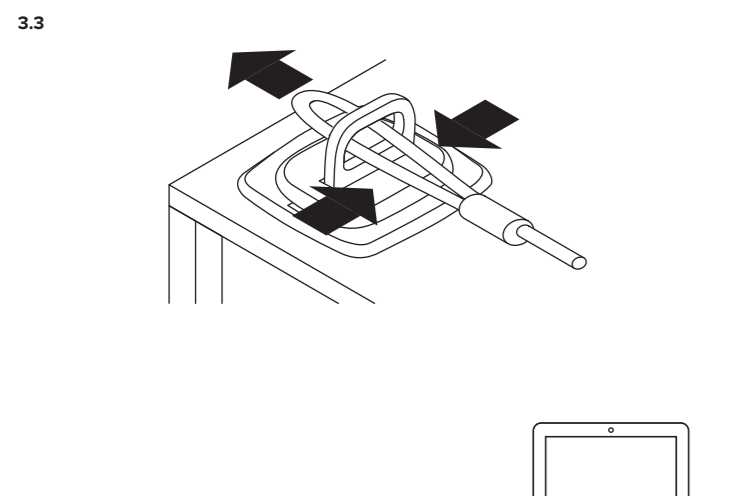
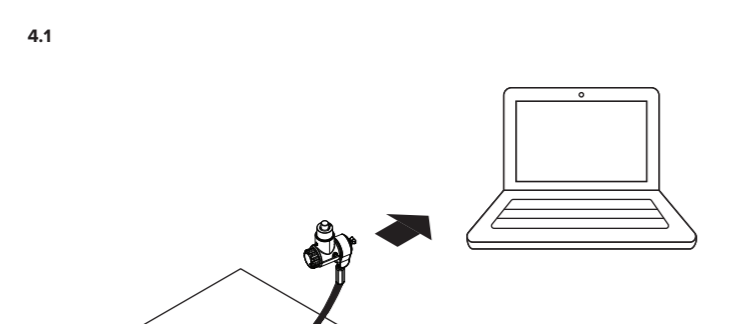

FOLDING

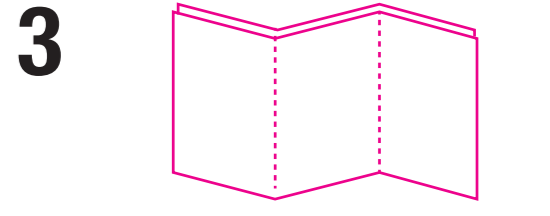
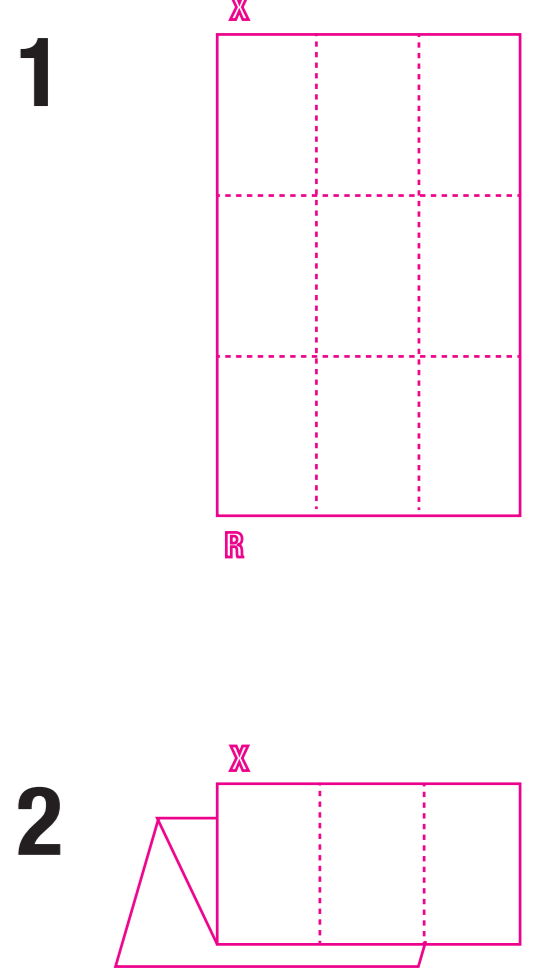

ENG Warranty

2 YEAR LIMITED WARRANTY: We pride ourselves on the quality of our products. For complete warranty details and a list of our worldwide offices, please visit www.targus.com.

Product Registration

Targus recommends that you register your Targus accessory shortly after purchasing it. Go to targus.com/us/product_registration

Technical Support

For technical questions, please visit:
USA: targus.com/us/support
Australia: targus.com/au/support
Canada: targus.com/ca/support
Latin America: soporte@targus.com

DE Garantie

2 JAHRE BEGRENZTE GARANTIE: Wir sind stolz auf die Qualität unserer Produkte. Einzelheiten zur Garantie und eine Übersicht der Niederlassungen weltweit finden Sie unter www.targus.com.

Produktregistrierung

Targus empfiehlt, dass Sie Ihr Targus Zubehör nach dem Kauf zeitnah registrieren. Gehen Sie zu targus.com/us/product_registration

Technischer Support

Bei technischen Fragen besuchen Sie bitte:
USA: targus.com/us/support
Australia: targus.com/au/support
Canada: targus.com/ca/support
Latin America: soporte@targus.com

ES Garantía

2 AÑO DE GARANTÍA LIMITADA: Estamos orgullosos de la calidad de nuestros productos. Si desea consultar toda la información relativa a la garantía y una lista de nuestras oficinas en todo el mundo, visite www.targus.com.

Registro del producto

Targus le recomendamos que registre su accesorio de Targus cuanto antes tras la compra. Visite targus.com/us/product_registration

Asistencia técnica

Para consultas técnicas, visite:
USA: targus.com/us/support
Australia: targus.com/au/support
Canada: targus.com/ca/support
Latin America: soporte@targus.com

FR Garantie

GARANTIE LIMITÉE À 2 ANS: nous sommes fiers de la qualité de nos produits. Pour avoir des informations complètes sur nos garanties et une liste de nos bureaux, à travers le monde, veuillez consulter le site www.targus.com.

Enregistrement du produit

Targus vous recommande d'enregistrer votre accessoire Targus immédiatement après l'achat. Allez sur targus.com/us/product_registration

Assistance technique

Pour de plus amples informations, veuillez consulter le site:
USA: targus.com/us/support
Australia: targus.com/au/support
Canada: targus.com/ca/support
Latin America: soporte@targus.com

IT Garanzia

GARANZIA LIMITATA DI 2 ANNI: Siamo orgogliosi della qualità dei nostri prodotti. Per conoscere i dettagli completi della garanzia e avere un elenco dei nostri uffici nel mondo, visitate www.targus.com.

Registrazione prodotto

Targus consiglia di registrare il vostro accessorio Targus entro breve tempo dall'acquisto. Andate su targus.com/us/product_registration

Supporto tecnico

Per domande tecniche, si prega di visitare:
USA: targus.com/us/support
Australia: targus.com/au/support
Canada: targus.com/ca/support
Latin America: soporte@targus.com

NL Garantie

2 JAAR BEPERKTE GARANTIE: We zijn trots op de kwaliteit van onze producten. Voor volledige garantiemeldingen en een lijst van onze internationale kantoren, gaat u naar www.targus.com.

Productregistratie

Targus raadt u aan uw Targus-accessoire kort na aankoop te registreren. Ga naar targus.com/us/product_registration

Technische ondersteuning

Ga voor technische vragen naar:
USA: targus.com/us/support
Australia: targus.com/au/support
Canada: targus.com/ca/support
Latin America: soporte@targus.com

PT Garantia

GARANTIA LIMITADA DE 2 ANOS: Orgulhamo-nos da qualidade dos nossos produtos. Para obter informações completas sobre a garantia e uma lista dos nossos escritórios em todo o mundo, consulte www.targus.com.

Registro do produto

A Targus recomenda o registro do seu acessório Targus logo após a respectiva compra. Visite targus.com/us/product_registration

Apoio técnico

Para questões técnicas, consulte:
USA: targus.com/us/support
Australia: targus.com/au/support
Canada: targus.com/ca/support
Latin America: soporte@targus.com

TR Garanti

2 YIL SINIRLI GARANTI: Ürünlerimizin kalitesinden gurur duyuyoruz. Garanti koşulları hakkında ayrıntılı bilgi ve tüm dünyadaki ofislerimizin bir listesini için lütfen ziyaret edin: www.targus.com

Ürün Kaydı

Targus, Targus aksesuarınızı satın aldıktan sonra mümkün olan en kısa sürede kaydettirmenizi önerir. targus.com/us/product_registration (ürün kaydı) sayfasına gidin.

Teknik Destek

Teknik sorularınız için, lütfen web sitemizi ziyaret edin:
USA: targus.com/us/support
Australia: targus.com/au/support
Canada: targus.com/ca/support
Latin America: soporte@targus.com

RU Гарантия

2-ЛЕТНЯЯ ОГРАНИЧЕННАЯ ГАРАНТИЯ: Мы гордимся качеством нашей продукции. Более подробную информацию о гарантии и список наших офисов в разных странах можно найти на сайте www.targus.com.

Регистрация продукта

Компания Targus рекомендует зарегистрировать изделие Targus сразу после его приобретения. Для этого перейдите в раздел targus.com/us/product_registration

Техническая поддержка

При возникновении технических вопросов, пожалуйста, посетите следующие веб-сайты:
USA: targus.com/us/support
Australia: targus.com/au/support
Canada: targus.com/ca/support
Latin America: soporte@targus.com

AUSTRALIAN AND NEW ZEALAND CONSUMERS ONLY

Thank you for your purchase. Targus warrants to the original purchaser that its products are free from defects in materials and workmanship, during the specified warranty period, and lasts as long as the original purchaser owns the product. The warranty period is stated on the packaging or in the documentation provided with this Targus product.

Under Australian and/or New Zealand Consumer Laws, in addition to any warranty Targus gives, our products come with guarantees that cannot be excluded. You are entitled to a replacement or refund for a major failure and compensation for any other reasonably foreseeable loss or damage.



410-4211-001A