

USER MANUAL

MODEL:

VP-550X

4K Presentation Switcher/Scaler



Contents

Introduction	1
Getting Started	1
Overview	2
Typical Applications	3
Defining VP-550X 4K Presentation Switcher/Scaler	4
Mounting VP-550X	6
Connecting VP-550X	7
Connecting the Output to a Balanced/Unbalanced Stereo Audio Acceptor	8
Microphone Setup	8
Operating and Controlling VP-550X	9
Using Front Panel Buttons	9
Controlling the Device via the OSD Menu	10
Operating via Ethernet	19
Using the Embedded Webpages	22
Browsing VP-550X Webpages	23
Setting Inputs	24
Setting Device Parameters	27
Changing Output Settings	30
Managing HDCP	33
Managing EDID	34
Setting Audio Parameters	35
Setting the RS-232 Port Function	37
Setting Web Page Access	41
Defining Auto Sync Off	44
Defining Auto Switching Mode	45
Defining Lock Mode	45
Hardware Diagnostics	46
Viewing Device Information	47
Upgrading the Firmware	48
Technical Specifications	49
Default Communication Parameters	51
Input Resolutions Support	51
Output Resolution Support	52
Default EDID	52
Protocol 3000	57
Understanding Protocol 3000	57
Protocol 3000 Commands	58
Result and Error Codes	66

Introduction

Welcome to Kramer Electronics! Since 1981, Kramer Electronics has been providing a world of unique, creative, and affordable solutions to the vast range of problems that confront the video, audio, presentation, and broadcasting professional daily. In recent years, we have redesigned and upgraded most of our line, making the best even better!

Getting Started

We recommend that you:

- Unpack the equipment carefully and save the original box and packaging materials for possible future shipment.
- Review the contents of this user manual.



Go to www.kramerav.com/downloads/VP-550X to check for up-to-date user manuals, application programs, and to check if firmware upgrades are available (where appropriate).

Achieving the Best Performance

- Use only good, quality connection cables (we recommend Kramer high-performance, high-resolution cables) to avoid interference, deterioration in signal quality due to poor matching, and elevated noise levels (often associated with low quality cables).
- Do not secure the cables in tight bundles or roll the slack into tight coils.
- Avoid interference from neighboring electrical appliances that may adversely influence signal quality.
- Position your Kramer **VP-550X** away from moisture, excessive sunlight, and dust.

Safety Instructions



Caution:

- This equipment is to be used only inside a building. It may only be connected to other equipment that is installed inside a building.
- For products with relay terminals and GPIO ports, please refer to the permitted rating for an external connection, located next to the terminal or in the User Manual.
- There are no operator serviceable parts inside the unit.



Warning:

- Use only the power cord that is supplied with the unit.
- Disconnect the power and unplug the unit from the wall before installing.
- Do not open the unit. High voltages can cause electrical shock! Servicing by qualified personnel only.
- To ensure continuous risk protection, replace fuses only according to the rating specified on the product label which located on the bottom of the unit.

Recycling Kramer Products

The Waste Electrical and Electronic Equipment (WEEE) Directive 2002/96/EC aims to reduce the amount of WEEE sent for disposal to landfill or incineration by requiring it to be collected and recycled. To comply with the WEEE Directive, Kramer Electronics has made arrangements with the European Advanced Recycling Network (EARN) and will cover any costs of treatment, recycling and recovery of waste Kramer Electronics branded equipment on arrival at the EARN facility. For details of Kramer's recycling arrangements in your particular country go to: <https://www.kramerav.com/il/quality/environment>.

Overview

Congratulations on purchasing your Kramer **VP-550X 4K Presentation Switcher/Scaler**.

VP-550X is a versatile, professional presentation scaler/switcher for 4K@60 (4:4:4) HDMI, USB-C, VGA, and Composite video (CV) signals. The unit scales the video and supports both provides options to use the embedded digital audio and analog audio input signals. After processing and scaling, the embedded AV signal is sent to the two (mirrored) HDMI outputs simultaneously. The audio is also sent to a balanced stereo audio output.

VP-550X provides exceptional quality, advanced and user-friendly operation, and flexible connectivity.

Exceptional Quality

- High-Performance Switcher/Scaler — Scales HDMI, USB-C (Alt-DP), VGA, and Composite video signals for outputting to two mirrored HDMI outputs. Constant output sync prevents signal disruption when switching between inputs and when no video is detected.
- High-Resolution Video — Supports and scales to/from any resolution, up to 4K@60Hz (4:4:4). Complies with HDCP 2.2. Supports HDR10, CEC, xvYCC color (on input), Dolby TrueHD/DTS-HD Master Audio (by-pass), as specified in HDMI 2.0.
- Complies with HDMI, HDCP 2.2 and HDR10 standards.
- Professional Video Quality — Provides selectable aspect ratios (full, best fit, over-scan, under-scan, letter box, and pan scan). Includes a built-in ProcAmp for color, hue, sharpness, noise, contrast, and brightness control. Supports PixPerfect™, Kramer's precision pixel mapping and high-quality scaling technology with full up-scaling and down-scaling of all video input signals.
- Powerful Audio Features – Includes DSP with audio equalization, mixing, delay, and more.
- HDTV Compatible.
- 4K and Legacy Inputs — 7 HDMI and 1 USB-C inputs (4K@60 (4:4:4)), 1 VGA input, and 1 CV input.

Flexible Connectivity

- Versatile Audio Options — Includes a companion analog audio input for each of the 2 analog video inputs. Embedded audio is supported on the digital video inputs, and an additional (AUX) audio input is provided to enable the user to embed analog audio when HDMI or USB-C is selected. In addition, users select to bypass an embedded audio input, for example, to support multi-channel, compressed audio formats like Dolby and DTS. Provides an independent microphone input (with optional 48V phantom power) for mixing, switching or talk-over.
- Provides an independent microphone input on a 3-PIN terminal block (with optional 48V phantom power) for mixing, switching, or talk-over.
- Besides the audio embedded on HDMI outputs, the audio signal is also extracted (de-embedded) and output as a balanced stereo analog audio signal.
- Video Inputs – 7 HDMI, 1 USB-C, 1 VGA, and 1 CV.
- Video Outputs – 2 HDMI (mirrored).

Advanced and User-friendly Operation

- Versatile Powering Options – Powered by a universal power supply (100-240V AC) and provides up to 18W of power to the USB-C input, HDTV.
- Non-Volatile Memory – Saves final settings before shutdown and retains them for next power up.
- Convenient Control Options — Local control via front panel buttons (input selection, audio mute, freeze, and front panel lock), RS-232, IR remote, and OSD. Long-distance control via Ethernet using embedded web pages.
- Easy Installation – 19" enclosure for rack mounting a unit in a 1U rack space with included rack ears and universal 100-240V AC power connection.
- Auto-switching and auto-scanning of inputs.
- Advanced EDID management for each input.

Typical Applications

VP-550X is ideal for these typical applications:

- Projection systems in conference rooms, corporate boardrooms, hotels, and auditoriums.
- Home theater up-scaling.

Controlling your VP-550X

Control your VP 550X directly via the front panel push buttons with on-screen menus, or:

- By RS-232 serial commands transmitted by a touch screen system, PC, or other serial controller.
- Remotely, from the infrared remote-control transmitter.
- Through the Ethernet with the use of built-in user-friendly webpages.

Defining VP-550X 4K Presentation Switcher/Scaler

This section defines the **VP-550X** front and back panels.

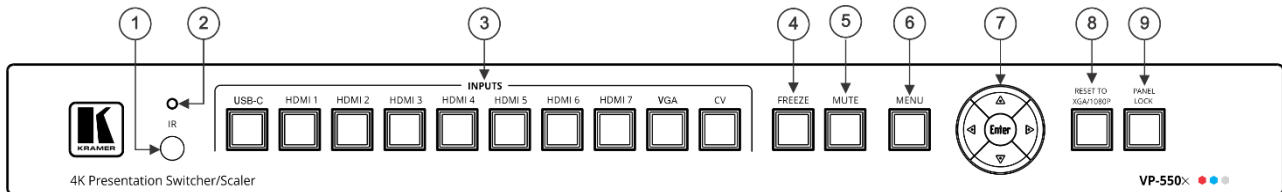

Figure 1: VP-550X 4K Presentation Switcher/Scaler Front Panel

#	Feature	Function	
①	IR Receiver	Receives signals from the remote-control transmitter.	
②	IR LED	Lights when the unit accepts IR remote commands.	
③	Input Selector Buttons	USB-C	Press to select a USB-C source.
		HDMI	Press to select the HDMI input (from HDMI 1 to HDMI 7).
		VGA	Press to select the computer graphics input.
		CV	Press to select the composite video input.
④	FREEZE Button	Press to freeze/unfreeze the output video image. Not applicable when in video bypass mode.	
⑤	MUTE Button	Press to toggle between muting (blocking out the sound) and enabling the audio output. Muting the audio is not applicable when in audio bypass mode.	
⑥	MENU Button	Press to enter/escape the on-screen display (OSD) menu.	
⑦	Navigation Buttons	◀	Press to decrease numerical values or select from several definitions. When not within the OSD menu mode, press to decrease the output volume.
		▲	Press to move up the menu list.
		▶	Press to increase numerical values or select from several definitions. When not within the OSD menu mode, press to increase the output volume.
		▼	Press to move down the menu list.
		ENTER	Press to accept changes and change the SETUP parameters.
⑧	RESET TO XGA/1080p Button	Press and hold for about 5 seconds to toggle resetting the video resolution to XGA or 1080p.	
⑨	PANEL LOCK Button	Press and hold for about 3 seconds to lock/unlock the front panel buttons (see Locking and Unlocking Front Panel Buttons on page 9).	

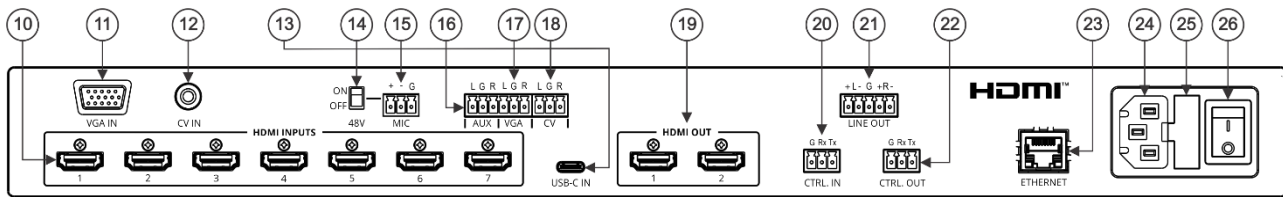

Figure 2: VP-550X 4K Presentation Switcher/Scaler Rear Panel

#	Feature	Function
⑩	HDMI INPUT Connectors	Connect to an HDMI source (from 1 to 7).
⑪	VGA IN 15-pin HD Connector	Connect to a computer graphics source.
⑫	CV IN RCA Connector	Connect to a composite video source.
⑬	USB-C IN Connector	Connect to a USB-C source. Charges up to 18W.
⑭	48V MIC Switch	Move up (ON) to select a condenser type microphone; down (OFF) to select a dynamic-type microphone.
⑮	MIC 3-pin Terminal Block Connector	Connect to a microphone source.
⑯	AUX 3-pin Terminal Block Connector	Connect to an auxiliary stereo analog audio source.
⑰	VGA 3-pin Terminal Block Connector (audio signal related to VGA IN)	Connect to the stereo analog audio associated with the computer graphics source.
⑱	CV 3-pin Terminal Block Connector (audio signal related to CV IN)	Connect to the stereo analog audio associated with the composite video source.
⑲	HDMI OUT Connectors	Connect to HDMI acceptors (from 1 to 2).
⑳	CTRL IN 3-pin Terminal Block Connector	Connect to a PC or remote controller to control VP-550X via RS-232 Protocol commands.
㉑	LINE OUT Balanced Stereo 5-pin Terminal Block Connector	Connect to a balanced stereo analog audio acceptor.
㉒	CTRL OUT 3-pin Terminal Block Connectors	Connect to an acceptor (for example, a display) to control it via RS-232 commands.
㉓	ETHERNET RJ-45 Connector	Connects to the PC or other Serial Controller through computer networking.
㉔	Mains Socket	Connect the mains power cord.
㉕	Mains Fuse Holder	Fuse for protecting the device.
㉖	Power Switch	Switch for turning the unit ON or OFF.

Mounting VP-550X

This section provides instructions for mounting **VP-550X**. Before installing, make sure the environment is within the recommended range:



- Operation temperature – 0° to 40°C (32 to 104°F).
- Storage temperature – -40° to +70°C (-40 to +158°F).
- Humidity – 10% to 90%, RHL non-condensing.

**Caution:**

- Mount **VP-550X** before connecting any cables or power.

**Warning:**

- Ensure that the environment (as in maximum ambient temperature and air flow) is compatible for the device.
- Avoid uneven mechanical loading.
- Appropriate consideration of equipment nameplate ratings should be used for avoiding overloading of the circuits.
- Reliable earthing of rack-mounted equipment must be maintained.

To mount the VP-550X on a rack:

Attach both rack ears by removing the screws from each side of the machine and replacing those screws through the rack ears or place the machine on a table.

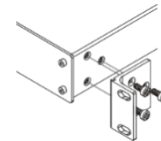

For more information go to www.kramerav.com/downloads/VP-550X

Connecting VP-550X



Always turn off the power to each device before connecting it to your **VP-550X**. After connecting your **VP-550X**, connect its power and then turn on the power to each device.

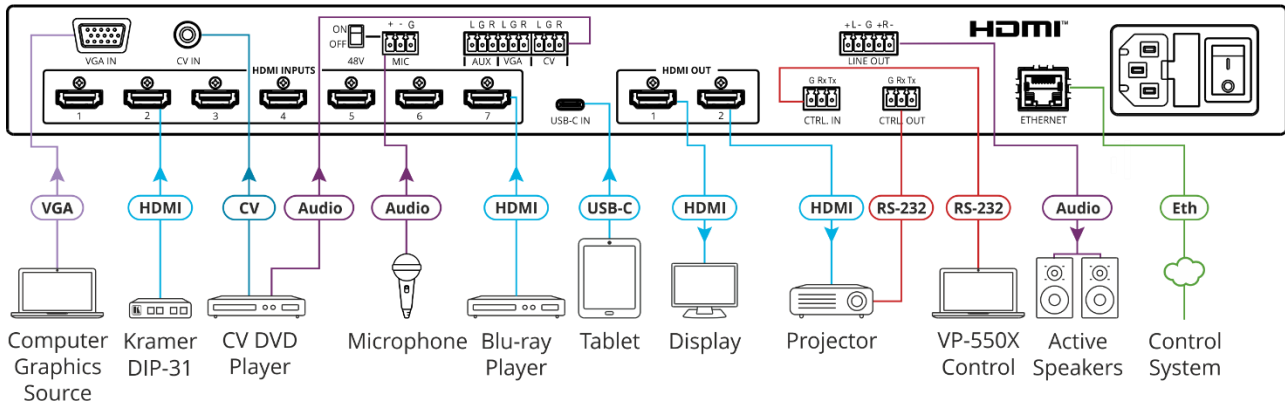

Figure 3: Connecting to the **VP-550X** Rear Panel

To connect the **VP-550X** as illustrated in the example in [Figure 3](#):

1. Connect a computer graphics source (for example, a laptop) to the VGA IN15-pin HD Input connector (11).
2. Connect a composite video source (for example, a DVD player) to the CV IN RCA connector (12).
3. Connect up to 7 HDMI sources (for example, a Blu-ray player to HDMI 5) to the HDMI INPUT connectors (10).
4. Connect VGA and CV stereo audio sources to the audio input terminal block connectors (18) (for example, the CV DVD player audio source to the CV audio input).
5. Connect a microphone to the 3-PIN terminal block (15) and set the 48V switch (14) ON or OFF, as required.
6. Connect up to 2 HDMI OUT connectors (19) to HDMI acceptors (for example, HDMI 1 to a display and HMDI 2 to a projector).
7. Connect the LINE OUT 4-pin terminal block connector (21) to active speakers (for example, Kramer **Tavor 5-O** speakers).
8. Connect the RS-232 CTRL OUT 3-pin terminal block connector (22) to the RS-232 port of an external device (for example, the projector connected to HDMI 2).
9. Connect the RS-232 CTRL IN 3-pin terminal block connector (20) to the RS-232 port on a controller (for example, a laptop) to control the **VP-550X**.
10. Connect the ETHERNET RJ-45 port (23) to the Ethernet.
11. Connect the power cord to the **VP-550X** mains socket (24) and to the mains electricity (not shown in [Figure 3](#)).

Connecting the Output to a Balanced/Unbalanced Stereo Audio Acceptor

The following are the pinouts for connecting the output to a balanced or unbalanced stereo audio acceptor:

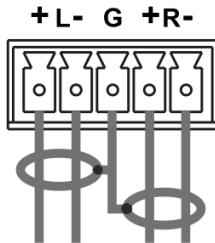

Figure 4: Connecting to a Balanced Stereo Audio Acceptor

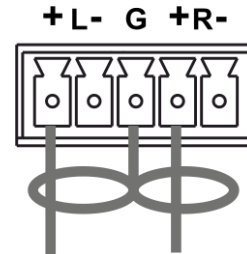

Figure 5: Connecting to an Unbalanced Stereo Audio Acceptor

Microphone Setup

Condenser Microphone Pinout

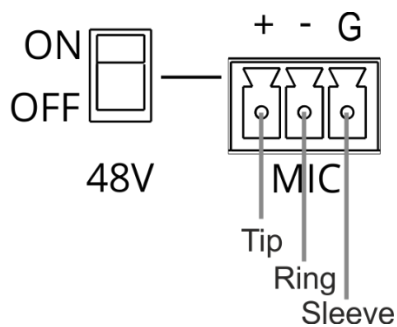

Figure 6: Condenser Microphone Pinout

Dynamic Microphone Pinout

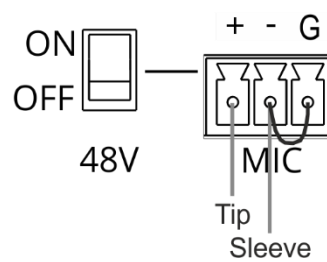

Figure 7: Dynamic Microphone Pinout

For optimum range and performance use the recommended Kramer cables available at www.kramerav.com/product/VP-550X.

Operating and Controlling VP-550X

Using Front Panel Buttons

Press the VP-550X front panel buttons to:

- Select the required INPUT (USB-C, HDMI, VGA, or CV).
- Freeze and/or mute the output.
- Reset the resolution to XGA/1080p.
- Lock / Unlock the front panel buttons (see [Locking and Unlocking Front Panel Buttons](#) on page 9).
- Control the device via the OSD menu, using the MENU, ENTER, and navigation buttons (see [Controlling the Device via the OSD Menu](#) on page 10).

Locking and Unlocking Front Panel Buttons

The front panel buttons can be locked (disabled) to prevent unintentional pressing of the buttons. Locking modes are set through the Advanced webpage (see [Defining Lock Mode](#) on page 45) or the ADVANCED OSD menu (see [Setting Lock Mode Functionality](#) on page 17).

Locking Procedure

The locking procedure is the same for all locking modes.

To lock the front panel buttons:

- Press and hold **PANEL LOCK** ⑨ for about 3 seconds.
The Panel Lock button lights blue and the front panel buttons are locked.

Unlocking Procedure

Unlocking procedure is specific for locking modes.

To unlock the front panel buttons:

- For All or Menu Only Lock modes – Press and hold **PANEL LOCK** ⑨ for about 3 seconds.
- For All & Save or Menu Only & Save Lock modes – Press and hold **PANEL LOCK** ⑨ and **RESET TO XGA/1080P** ⑧ simultaneously for about 3 seconds.

The Panel Lock button light turns off and the front panel buttons are unlocked.

Controlling the Device via the OSD Menu

Use the menu and navigation buttons to control the **VP-550X** via the OSD menu (for more information, see [Navigating OSD Buttons](#) on page [10](#)).



The default OSD timeout is set to 10 seconds.

Use the OSD menu to perform the following operations:

- [Navigating OSD Buttons](#) on page [10](#).
- [Setting Image Parameters](#) on page [11](#).
- [Selecting the Input Signal](#) on page [12](#).
- [Setting Output Parameters](#) on page [12](#).
- [Setting the Audio Source](#) on page [13](#).
- [Setting OSD Parameters](#) on page [14](#).
- [Managing EDID](#) on page [15](#).
- [Setting HDCP](#) on page [15](#).
- [Setting Sleep Mode](#) on page [16](#).
- [Setting Switching Mode](#) on page [16](#).
- [Setting Ethernet Parameters](#) on page [17](#).
- [Setting Lock Mode Functionality](#) on page [17](#).
- [Setting Daily Reset Schedule](#) on page [18](#).
- [Viewing Device Hours](#) on page [18](#).
- [Viewing Device Information](#) on page [19](#).
- [Performing Factory Reset](#) on page [19](#).

Navigating OSD Buttons

To enter and use the OSD menu buttons:

VP-550X enables you to control and define the device parameters through the OSD by using the front panel MENU buttons.

1. Press MENU.
2. Press:
 - **ENTER** to accept changes and to change the menu settings.
 - **Arrow buttons** to move through the OSD menu, which is displayed on the video output.
 - **MENU** to exit the menu.

Setting Image Parameters

VP-550X enables you to set the image parameters such as contrast, brightness, and more.

To set the image parameters:

1. On the front panel press **MENU**. The menu appears.
2. Select **Picture** > press **Enter** and define the image parameters based on the information in this table:

Menu Item	Function	
Contrast	Set the contrast.	
Brightness	Set the brightness.	
Finetune	Input Signal	Function
	VGA	Phase – set the phase of the sampling clock.
		Clock – set the frequency of the sampling clock.
		H-Position – set the horizontal picture position.
		V-Position – set the vertical picture position.
	Video	HUE – set the color hue.
		Saturation – set the color saturation.
		Sharpness – set the sharpness of the picture.
NR (Noise Reduction) – select the noise reduction filter: Off (default), Low, Middle or High.		
Color	Set the Red, Green, and Blue shades.	

Image parameters are set.

Selecting the Input Signal

Select the **VP-550X** input source through the OSD menu.

To set the input source:

1. On the front panel press **MENU**. The menu appears.
2. Select **Input** > press **Enter** and select the input source:
 - HDMI 1 to HDMI 7, USB-C, VGA, or CV.
3. Press **Enter**.

Input source is selected.

Setting Output Parameters

VP-550X enables setting output parameters such as the size of the image and output resolution via the OSD MENU buttons.

To set the output parameters:

1. On the front panel press **MENU**. The menu appears.
2. Select **Output** > press **Enter** and define the output parameters based on the information in this table:

Menu Item	Function			
Size	Set the size of the image: Full, Over Scan, Under 1, Under 2, Letter Box, Pan Scan, Best fit (default), and Follow In.			
Bypass mode	Yes (Bypass): Select for HDMI signals to bypass the scaler (no video processing). No (Scaler): Select to always scale the HDMI signals.			
Resolution	Select the output resolution (default, NATIVE HDMI):			
	Appears as	Output Resolution	Appears as	Output Resolution
	640x480 60	640x480 @60Hz	800x600 60	800x600 @60Hz
	1024x768 60	1024x768 @60Hz	1280x768 60	1280x768 @60Hz
	1280x800 60	1280x800 @60Hz	1280x1024 60	1280x1024 @60Hz
	1360x768 60	1360x768 @60Hz	1400x1050 60	1400x1050 @60Hz
	1440x900 60	1440x900 @60Hz	1600x1200 60	1600x1200 @60Hz
	1680x1050 60	1680x1050 @60Hz	1920x1200 60 RB	1920x1200 @60Hz RB
	2560x1600 60 RB	2560x1600 @60Hz RB	1920x1080 60	1920x1080 @60Hz
	1280x720 60	1280x720 @60Hz	2560x1440 60 RB	2560x1440 @60Hz RB
	720x480P 60	720x480P @60Hz	720x576P 50	720x576P @50Hz
	1280x720P 50	1280x720P @50Hz	1280x720P 60	1280x720P @60Hz
	1920x1080P 24	1920x1080P @24Hz	1920x1080P 25	1920x1080P @25Hz
	1920x1080P 30	1920x1080P @30Hz	1920x1080P 50	1920x1080P @50Hz
	1920x1080P 60	1920x1080P @60Hz	2560x1080P 50	2560x1080P @50Hz
	2560x1080P 60	2560x1080P @60Hz	3840x2160P 24	3840x2160P @24Hz
	3840x2160P 25	3840x2160P @25Hz	3840x2160P 30	3840x2160P @30Hz
3840x2160P 50(420)	4k2k @50Hz (4:2:0)	3840x2160P 60(420)	4k2k @60Hz (4:2:0)	
3840x2160P 50	3840x2160P @50Hz	3840x2160P 60	3840x2160P @60Hz	

Output parameters are selected.

Setting the Audio Source

VP-550X enables you to define the audio source per input, the audio delay time, the input and output volume, and the microphone and DSP settings.

To set the audio source:

1. On the front panel press **MENU**. The menu appears.
2. Select **Audio** > press **Enter** and define the audio parameters based on the information in this table:

Menu Item	Function	
Input	Set the audio input volume for HDMI 1 to HDMI 7, USB-C, VGA, and CV.	
Source	Set each HDMI input (1 to 7) or USB-C audio source to Automatic (default), Analog or Embedded.	
Mic Settings	Mic Mode	Set to Off (default), Mixer, Talkover, or Mic Only.
	When Mic Mode is set to Talkover (see Talkover Mode on page 14), set the following:	
	Depth [%]	Set the depth value to determine the decrease of the audio level during microphone takeover (press + to further decrease the Talkover audio output level; press – to lessen the Talkover output audio decrease level).
	Trigger [dB]	Set the trigger value to determine the microphone threshold level that triggers the audio output level decrease.
	Attack Time	Set the attack time to set the transition time of the audio level reduction after the signal rises above the threshold level.
	Hold Time	Set the hold time to define the time period Talkover remains active although the signal falls below the threshold level (for a short period of time).
	Release Time	Set the release time to define the transition time for the audio level to return from its reduced level to its normal level after the Hold Time period.
Settings	DRC	Set dynamic range compression Off (default) or On.
	Loudness	Set loudness Off (default) or On.
	Embedded In - > Out	Apply DSP (default) to the embedded audio or ByPass it.
Mic Volume	Set microphone volume (MIC).	
Equalizer	Select the slider button to set the loudness of specific frequencies.	

Audio source is set.

Talkover Mode

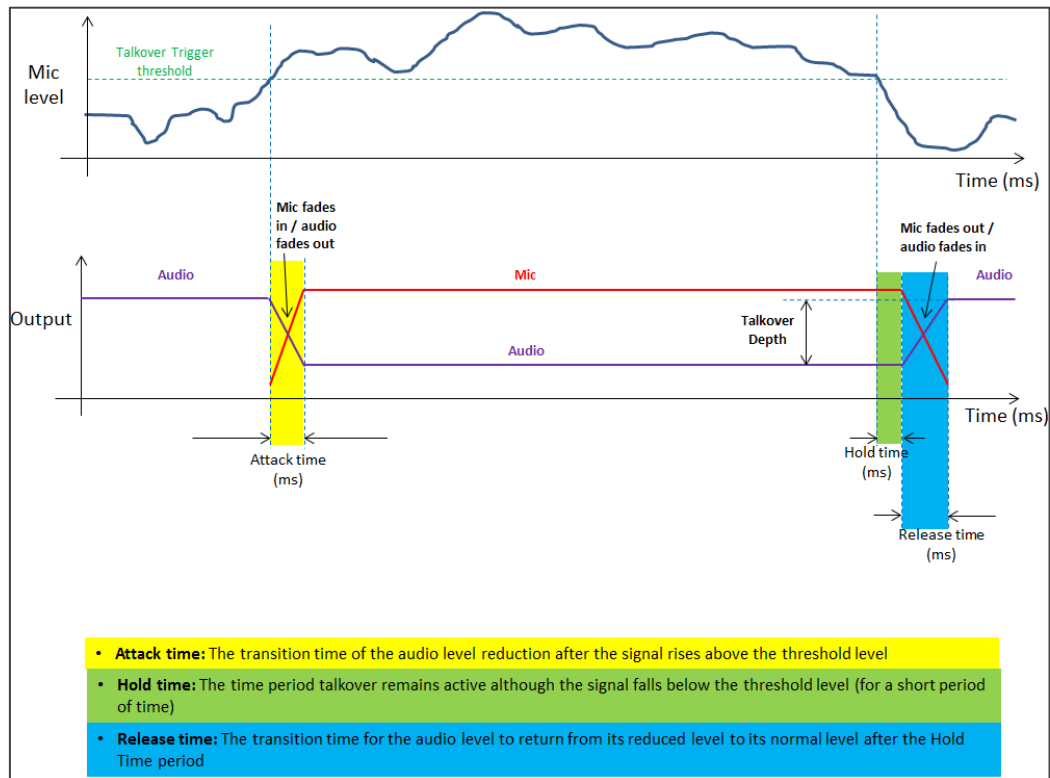

Figure 8: Talkover Mode

Setting OSD Parameters

VP-550X enables you to adjust OSD parameters for your convenience through the OSD MENU buttons.

To set the OSD parameters:

1. On the front panel press **MENU**. The menu appears.
2. Select **OSD** > press **Enter** and define the OSD parameters based on the information in this table:

Menu Item	Function
H-Position	Set the horizontal position of the OSD.
V-Position	Set the vertical position of the OSD.
Timer	Set the timeout period to Off or up to 60 seconds (default 10).
Transparency	Set the OSD background between 100 (transparent) and 0 (opaque).
Display	Select the information displayed on-screen during operation: <ul style="list-style-type: none"> • Info (default) – the information appears for 10 seconds. • On – the information appears constantly. • Off – the information does not appear.

OSD parameters are set.

Managing EDID

VP-550X enables you to manage the EDID through the OSD MENU buttons.

To manage the EDID:

1. On the front panel press **MENU**. The menu appears.
2. Click **EDID Manage** and define the EDID parameters based on the information in this table:

Menu Item	Function
<ul style="list-style-type: none"> • EDID on HDMI (1 to 7) • EDID on USB-C 	For each HDMI or USB-C input, select a built-in EDID and press enter: Def.1080P (default), Def. 4K(3G), Def. 4K(4:2:0), Def. 4K(6G), HDMI1 Output, HDMI2 Output
EDID on VGA	Default

EDID is defined.

Setting HDCP

VP-550X enables you to set the HDCP on the input and on the output through the front panel MENU buttons.

To set the HDCP on the inputs and outputs:

1. On the front panel press **MENU**. The menu appears.
2. Select **Advanced** > press **Enter** and define the HDCP parameters based on the information in this table:

Menu Item	Function
HDCP On Input	Set HDCP support on HDMI 1 to HDMI 7, USB-C inputs to ON (default) or OFF. Note that: <ol style="list-style-type: none"> 1. HDCP must be enabled (ON) to support HDCP encrypted sources. 2. Sources such as Mac computers always encrypt their outputs when detecting that the sink supports HDCP. If the content does not require HDCP, you can prevent these sources from encrypting by disabling (OFF) HDCP on the input.
HDCP On Output	Select Follow Output (default) or Follow Input on each output (HDMI OUT 1 and 2). Select Follow Output (recommended) for the scaler to output with HDCP encryption if the HDMI acceptor to which it is connected is HDCP compliant, and to output without HDCP if the acceptor is not HDCP compliant. Select Follow Input to change its HDCP output setting according to the HDCP of the input (recommended when the HDMI/HDCP output is connected to a splitter/switcher).

HDCP is set.

Setting Sleep Mode

VP-550X enables configuring when a connected display enters sleep mode using the Auto Sync Off feature. Auto Sync Off turns off the output after a period of not detecting a valid video signal on the input(s) until a valid input is again detected or any keypad button is pressed.

To set the Auto Sync Off:

1. On the front panel press **MENU**. The menu appears.
2. Select **ADVANCED** > **Enter**, and select **Auto Sync Off**.
3. Define Auto Sync Off based on the information in this table:

Menu Item	Function
Disable (default)	To always leave the outputs active.
Slow	To disable the outputs after ~ 2 minutes of no input detection.
Fast	To disable the outputs after ~ 10 seconds of no input detection.
Immediate	To disable the outputs ~ 0.5 seconds after detecting a loss of input signal.

Sleep mode is set.

Setting Switching Mode

VP-550X enables configuring automatic switching of the input source upon signal loss or when a source is plugged in.

To set the switching mode:

1. On the front panel press **MENU**. The menu appears.
2. Select **Advanced** > **Enter**, and select **Auto Switching**.
3. Select the switching mode based on the information in this table:

Menu Item	Function
Off (default)	For manual switching.
Auto Scan	Scans for a valid input when no signal is found on the selected input.
Last Connected	Automatically switches to the last connected input and reverts back to the previously selected input after that input is lost.

Setting Ethernet Parameters

VP-550X enables defining the Ethernet parameters through the MENU front panel buttons.

To set the Ethernet :

1. On the front panel press **MENU**. The menu appears.
2. Select **Advanced** > press **Enter** and define the Ethernet parameters based on the information in this table:

Menu Item	Function
IP Mode	Select Static IP (default) or DHCP.
Static IP Address	Enter to change the IP address.
Subnet Mask	Enter to change the subnet mask.
Default Gateway	Enter to change the default gateway.
TCP Port	Enter TCP port # (5000, by-default).
UDP Port	Enter UDP port # (50000, by-default).
IP	View the current IP address.
MAC ADDRESS	View the MAC address.
Link Status	View the link status.

Ethernet settings are defined.

Setting Lock Mode Functionality

VP-550X enables defining the function of the PANEL LOCK front panel button (9). For example, the PANEL LOCK button can be defined to lock all the front panel buttons or only the menu buttons.

To set the functionality of the LOCK front panel button:

1. On the front panel press **MENU**. The menu appears.
2. Select **Advanced** > **Enter** and select **Lock Mode**.
3. Set a panel Lock Mode base on the information in this table:

Menu Item	Function
All	All front panel buttons are locked.
All & Save	All front panel buttons are locked, and they remain locked after cycling power.
Menu Only	Only the menu buttons are locked.
Menu Only & Save	Only the menu buttons are locked, and they remain locked after cycling power.

Note - To unlock the front panels, see [Locking and Unlocking Front Panel Buttons](#) on page 9.

Lock mode is set.

Setting Daily Reset Schedule

For units operating 24/7, the Daily Reset Timer may be used to automatically reset the unit each day.



Note - This function reboots the unit. It does not reset any of the parameters.

To set a daily reset schedule:

1. On the front panel press **MENU**. The menu appears.
2. Select **Advanced** > press **Enter** and select **Daily Reset**.
3. Set the daily reset schedule.

Menu Item	Function	
Daily Reset	Disable daily reset (Off, default) or enable daily reset (On).	
Next Reset (h)	Set the number of hours before the next reset.	Set for the "Next Reset" to fix the time that the unit will be reset each day.
Next Reset (m)	Set the number of minutes before the next reset.	
After Power-Up	Define behavior following a power cycle: Disable – The Daily Reset Timer is turned off. Restart – The timer restarts when the unit is powered up (i.e., from then onwards, the unit resets each day at the time that the unit is powered up). Resume – The timer continues running after power returns (while powered down, the timer does not run).	

Daily Reset Schedule is defined.

Viewing Device Hours.

Lifetime shows the total number of hours that the machine has been in operation.

To view device hours:

1. On the front panel press **MENU**. The menu appears.
2. Select **Advanced**.
3. View Lifetime and view device hours.

Device hours are viewed.

Viewing Device Information

Device information includes the selected source, the input and output resolutions, and the software version.

To view the information:

1. On the front panel press **MENU**. The menu appears.
2. Select **Info** and view the following information: Source, Inputs, Outputs, and Version (current firmware version).

Device information is viewed.

Performing Factory Reset

VP-550X enables you to do a soft reset or full reset through the front panel MENU buttons.

To perform factory reset:

1. On the front panel press **MENU**. The menu appears.
2. Select **Factory** and select either Reset (full reset) or a Soft Reset (excluding Ethernet parameters), then click **Yes**.
Wait for completion of factory reset (resolution is set to Native).

Operating via Ethernet

You can connect to the VP-550X via Ethernet using either of the following methods:

- Directly to the PC using a crossover cable (see ([Connecting the Ethernet Port Directly to a PC](#) on page [19](#)).
- Via a network hub, switch, or router, using a straight-through cable (see [Connecting the Ethernet Port via a Network Hub or Switch](#) on page [21](#)).



If you want to connect via a router and your IT system is based on IPv6, speak to your IT department for specific installation instructions.

For information about Ethernet configurations, (see [Changing Ethernet Settings](#) on page [29](#)).

Connecting the Ethernet Port Directly to a PC

You can connect the Ethernet port of the VP-550X directly to the Ethernet port on your PC using a crossover cable with RJ-45 connectors.



This type of connection is recommended for identifying the VP-550X with the factory configured default IP address.

After connecting the VP-550X to the Ethernet port, configure your PC as follows:

1. Click **Start > Control Panel > Network and Sharing Center**.

2. Click **Change Adapter Settings**.
3. Highlight the network adapter you want to use to connect to the device and click **Change settings of this connection**.

The Local Area Connection Properties window for the selected network adapter appears as shown in [Figure 9](#).

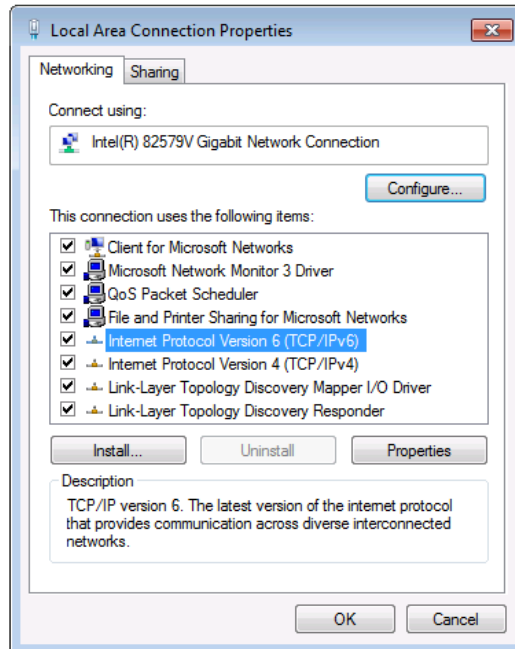

Figure 9: Local Area Connection Properties Window

4. Highlight either **Internet Protocol Version 6 (TCP/IPv6)** or **Internet Protocol Version 4 (TCP/IPv4)** depending on the requirements of your IT system.
5. Click **Properties**.

The Internet Protocol Properties window relevant to your IT system appears as shown in [Figure 10](#) or [Figure 11](#).

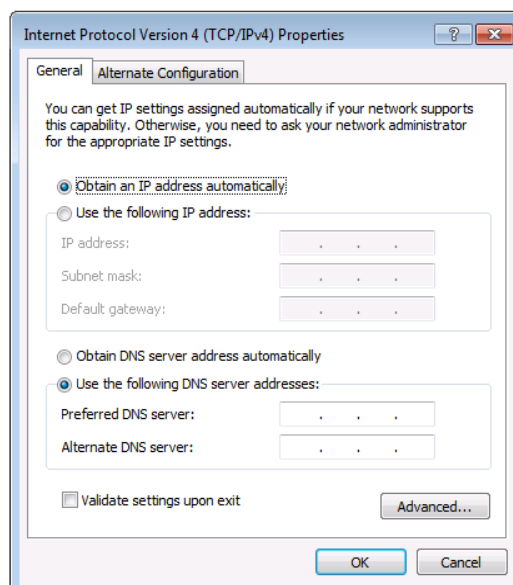

Figure 10: Internet Protocol Version 4 Properties Window

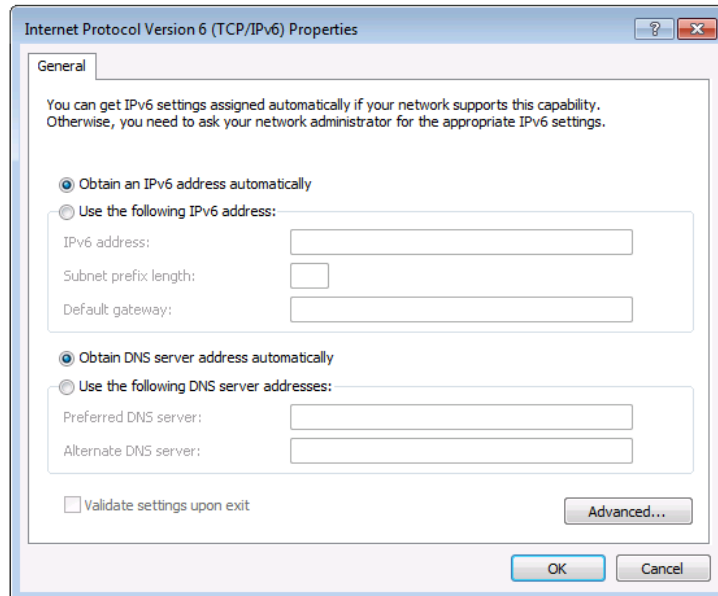

Figure 11: Internet Protocol Version 6 Properties Window

6. Select **Use the following IP Address** for static IP addressing and fill in the details as shown in [Figure 12](#).

For TCP/IPv4 you can use any IP address in the range 192.168.1.1 to 192.168.1.255 (excluding 192.168.1.39) that is provided by your IT department.

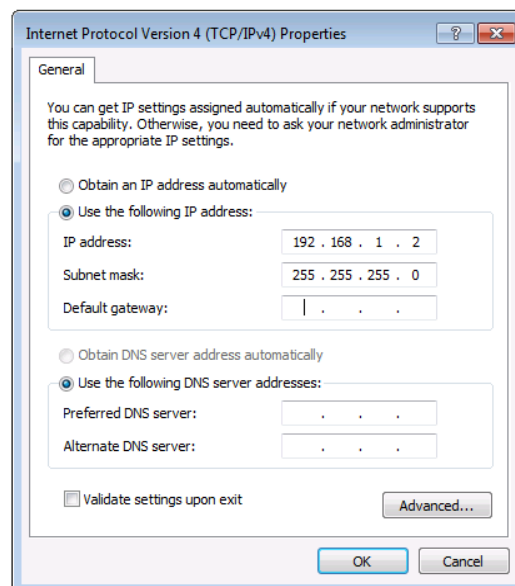

Figure 12: Internet Protocol Properties Window

7. Click **OK**.
8. Click **Close**.

Connecting the Ethernet Port via a Network Hub or Switch

You can connect the Ethernet port of the **VP-550X** to the Ethernet port on a network hub or using a straight-through cable with RJ-45 connectors.

Using the Embedded Webpages

The **VP-550X** can be operated remotely using the embedded webpages. The webpages are accessed using a Web browser and Ethernet connection.

Before attempting to connect:

- Do the procedures in [Operating via Ethernet](#) on page [19](#).
- Make sure that your browser is supported.

The following operating systems and Web browsers are supported:

Operating Systems	Versions
Windows 7	IE
	Firefox
	Chrome
	Safari
Windows 10	IE
	Edge
	Firefox
	Chrome
Mac	Safari
iOS	Safari



Some features might not be supported by some cellphone operating systems.

Browsing VP-550X Webpages

To browse the VP-550X webpages:

1. Open your Internet browser.
2. Type the IP Address of the device in the Address bar of your browser. For example, the default IP Address:



The Input Select webpage appears.

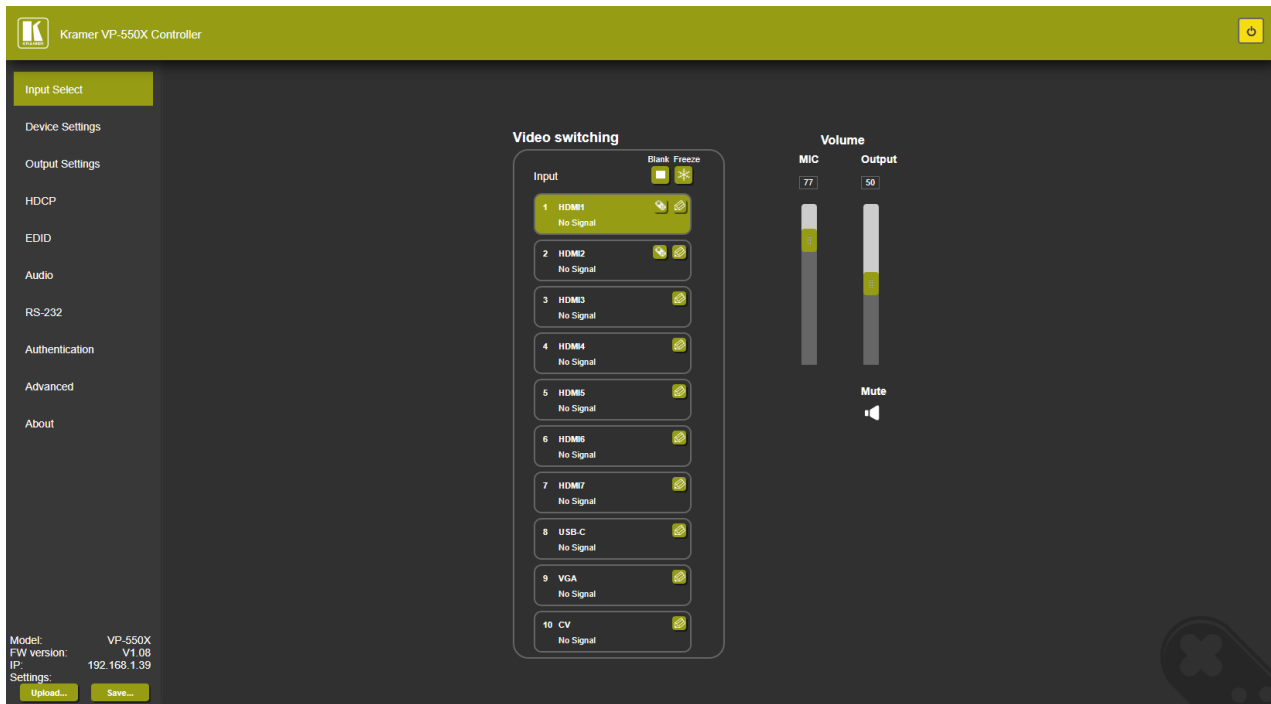

Figure 13: VP-550X Input Select Page with Navigation List on Left

The model's name, FW version, and IP Address appear on the lower left side of the main page. The lower part of the screen lets you save the settings and upload a saved setting.

3. Click the desired item in the navigation pane.

Web pages are accessed.

The VP-550X webpage enables performing the following functions:

- [Browsing VP-550X Webpages](#) on page [23](#).
- [Setting Inputs](#) on page [24](#).
- [Setting Device Parameters](#) on page [27](#).
- [Changing Output Settings](#) on page [30](#).
- [Managing HDCP](#) on page [33](#).
- [Managing EDID](#) on page [34](#).
- [Setting Audio Parameters](#) on page [35](#).
- [Setting the RS-232 Port Function](#) on page [37](#).
- [Setting Web Page Access](#) on page [41](#).
- [Defining Auto Sync Off](#) on page [44](#).
- [Defining Auto Switching Mode](#) on page [45](#).
- [Defining Lock Mode](#) on page [45](#).
- [Hardware Diagnostics](#) on page [46](#).
- [Viewing Device Information](#) on page [47](#).

Setting Inputs

Use the Input Select page to configure the inputs, route an input to the outputs, and set the mic and output volumes.

- [Video Switching](#) on page [25](#).
- [Setting an Input](#) on page [26](#).
- [Configuring Remote Device Settings](#) on page [27](#).
- [Setting the Volume](#) on page [27](#).

Video Switching

VP-550X enables you to individually configure settings for each of the video inputs via the Switching page.

To select an input to route to the outputs:

1. In the Navigation pane, click **Input Select**. The Input Select page appears.

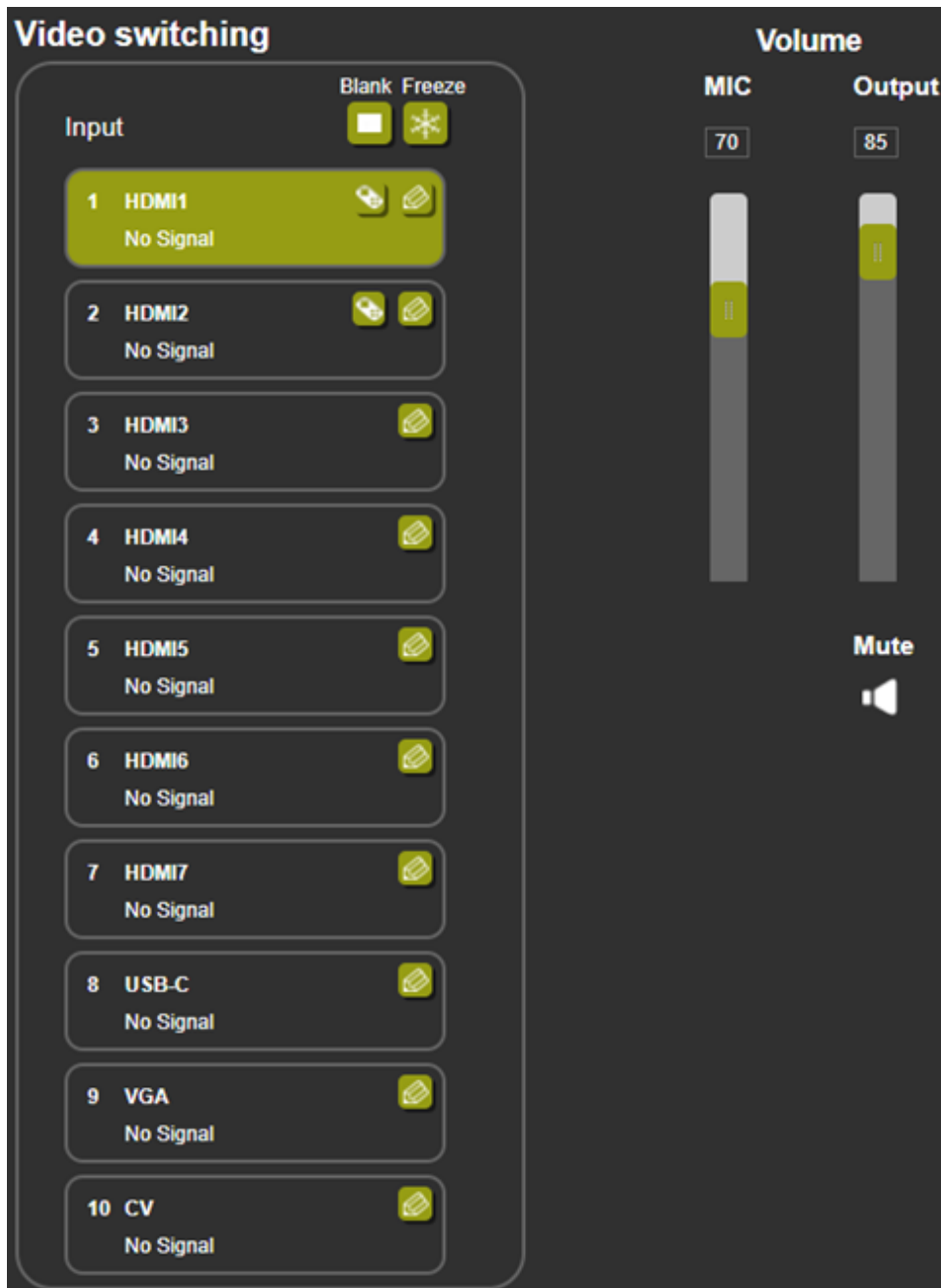



Figure 14: Input Select Page

2. Click an input button. The selected input is routed to both outputs.

 Use the freeze icon (❄️) to freeze a selected input and the blank button (👉) to display a blank image.

Selected input is routed to outputs.

Setting an Input

To edit an input:

1. In the Navigation pane, click **Input Select**. The Input Select page appears (see [Figure 14](#)).
2. In the Video switching area, click the  button in an HDMI/CV/VGA button to edit that input.

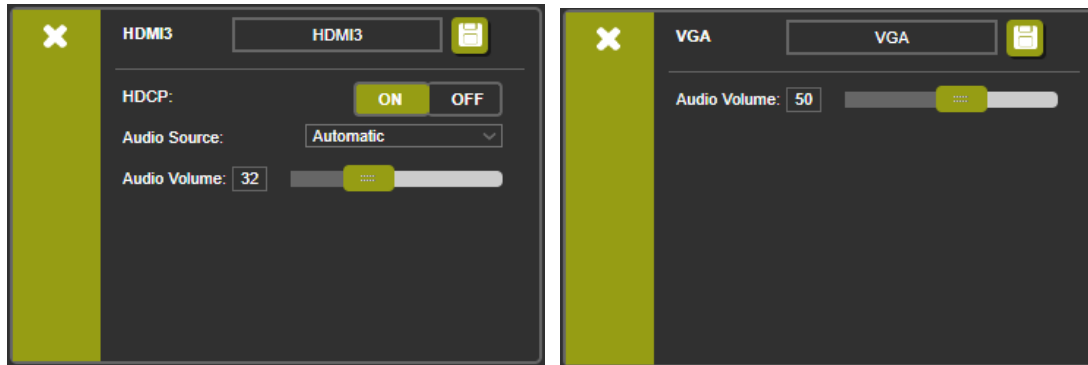



Figure 15: Input Select Page – Editing an Input Button

3. Edit the following features:

- Change the input name and click .
- Set the input **Audio Volume**.
- For HDMI inputs only, set the HDCP on the input to ON or OFF.



If HDCP is disabled on an input, an HDCP encrypted source will not pass through the unit.

- For HDMI inputs only, select an analog or embedded audio source or set input audio selection to automatic:
 - Automatic – The embedded audio on the HDMI input is selected for an HDMI signal, or the analog audio input is selected if the input is not HDMI (for example, for a DVI input signal).
 - Analog – The analog audio input is selected.
 - Embedded – The embedded audio in the HDMI signal is selected.

Audio is set.

Configuring Remote Device Settings

To configure the Remote device settings:

Remote device settings allow you to use a remote HDMI or VGA “Step-In” input device connected to **VP-550X** through a “Step-In” video switcher such as Kramer’s DIP30.

1. Go to the Navigation List > **Input Select** > below **Video switching** > **Input (HDMI1 or HDMI2)**, select the Remote device settings icon. 



Note – Repeat these steps as necessary for each HDMI input.

2. Set the input as **ON** or **OFF**. If **ON** is selected, then you can choose a Step-In input such as HDMI or VGA.
3. To enable the Step-In, select **ON**.
4. Select an output on the Step-In device such as **HDMI2** or **VGA**.
5. To exit, click .

Remote device settings configured.

Setting the Volume

To set the mic and output volumes:

1. In the Navigation pane, click **Input Select**. The Input Select page appears (see [Figure 14](#)).
2. Use the Volume sliders to adjust:
 - MIC  microphone volume.
 - Output (LINE OUT ) volume.

You can also set a specific volume by entering the volume value in the text box above a slider and pressing **Enter** on your PC.

3. Click the Mute icon to mute the line audio signal.

Volume is set.

Setting Device Parameters

The Device Settings page shows the model’s name, its serial number and MAC address, and its current firmware version.

The Device Settings page enables you to do these functions:

- [Updating the Firmware](#) on page [28](#).
- [Changing Ethernet Settings](#) on page [29](#).
- [Soft Factory Reset](#) on page [30](#).

Updating the Firmware

Upgrade VP-550X easily through the webpages or via the PROG USB port ⑩ (see [Upgrading the Firmware](#) on page 48).

To update the firmware:

1. In the Navigation pane, click **Device Settings**. The Device Settings page appears.

The screenshot shows the 'Device Settings' page for a VP-550X device. The page is dark-themed and contains the following elements:

- Device Information:**
 - Model: VP-550X
 - Serial_Number: 14092020190372
 - MAC Address: 00-1d-56-04-cf-fc
 - Firmware Version: V1.08
 - Firmware Update: A file selection field showing 'Choose File' and 'No file chosen', with an 'Upgrade' button to the right.
- Network Settings:**
 - DHCP: A checkbox labeled 'DHCP On' is checked.
 - IP Address: A text input field containing '192 · 168 · 1 · 39'.
 - Static IP Address: A text input field containing '192 · 168 · 1 · 39'.
 - Gateway: A text input field containing '192 · 168 · 0 · 1'.
 - Subnet: A text input field containing '255 · 255 · 0 · 0'.
 - TCP Port: A text input field containing '5000'.
 - UDP Port: A text input field containing '50000'.
 - A 'Set changes' button is located to the right of the UDP Port field.
- Other Options:**
 - A 'Soft Factory Reset' button is located at the bottom left of the settings area.

Figure 16: Device Settings Page

2. Click **Choose File**. An Open window appears.
 3. Select the correct firmware file.
 4. Click **Open**. The selected file appears in the **Firmware Update** field.
 5. Click **Upgrade**.
The new firmware is uploaded, the firmware is upgraded and the system restarts.
Upon completion, the webpage refreshes.
- Firmware is updated.

Changing Ethernet Settings

To change Ethernet parameters:

1. In the Navigation pane, click **Device Settings**. The Device Settings page appears (see [Figure 16](#)).
2. Check/uncheck the **DHCP** box **ON** or **OFF** (default).
When DHCP is checked, Static IP Address, gateway and Subnet are disabled.
3. Click **Set changes**. The following message appears.

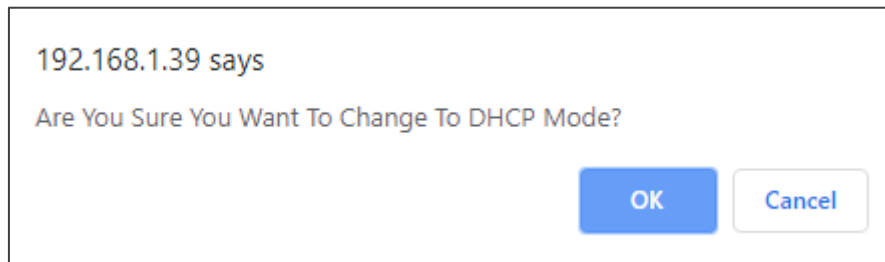

Figure 17: Device Settings Page – Changing DHCP Mode

4. Click **OK**.
5. If DHCP is **OFF**, change any of the parameters (IP Address, Netmask and/or Gateway).
6. Click **Set Changes**.



- After changing the IP Address, or DHCP to ON, the webpage reloads with the new IP address.
- After changing the Subnet mask, turn the **VP-550X** power off and then on again.

Any change in the device settings requires confirmation.

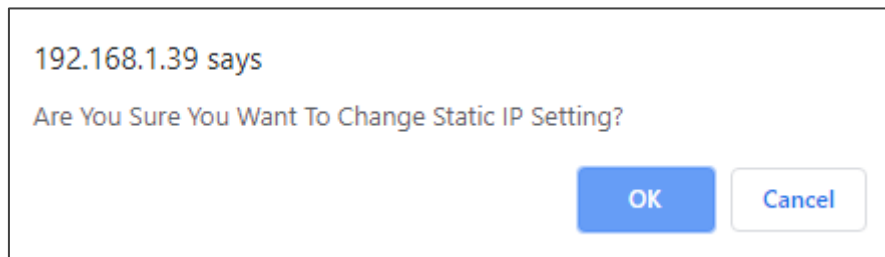

Figure 18: Device Settings Page – Static IP Confirmation

7. Click **OK**.

Ethernet parameters are changed.

Soft Factory Reset

To reset the device to its factory default parameters (as in resetting all parameters except for the Ethernet parameters):

1. In the Navigation pane, click **Device Settings**. The Device Settings page appears.
2. Click **Soft Factory reset** the following message appears:

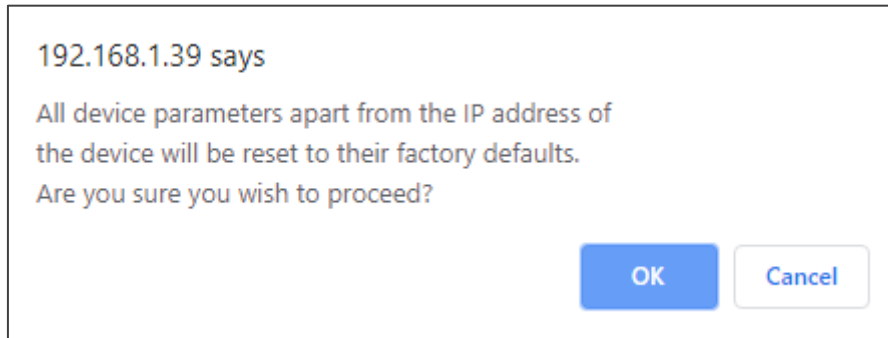

Figure 19: Device Settings Page – Factory Reset Message

3. Click **OK** and wait for the webpage to reload following factory reset.

Soft Factory Reset is complete.



See [Default Communication Parameters](#) on page [51](#) to view other factory reset procedures.

Changing Output Settings

VP-550X enables performing the following functions on the outputs:

- [Selecting Resolution](#) on page [31](#).
- [Setting Image Size on the Display](#) on page [31](#).
- [Setting Bypass Mode](#) on page [32](#).
- [Adjusting the Picture](#) on page [32](#).
- [Finetuning the Image](#) on page [32](#).

Selecting Resolution

To select the resolution:

1. In the Navigation pane, click **Device Settings**. The Device Settings page appears.

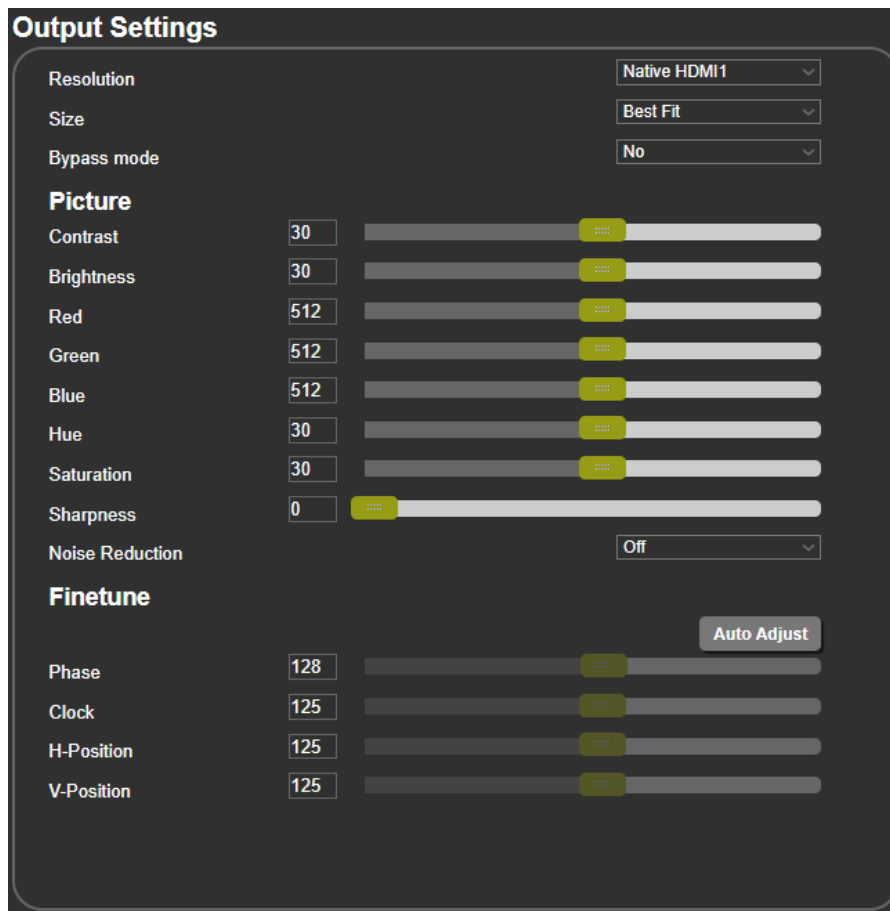

Figure 20: Output Settings Page

2. Open the drop-down box next to **Resolution** to select the output resolution. Output resolution is selected.

Setting Image Size on the Display

To set the image size:

1. In the Navigation pane, click **Output Settings**. The Output Settings page appears.
2. Open the drop-down box next to **Size** to set the image size.

Image size is set.

Setting Bypass Mode

To set bypass mode:

1. In the Navigation pane, click **Output Settings**. The Output Settings page appears.
2. Open the drop-down box next to **Bypass mode** to set the bypass mode to:
 - No – Process the HDMI signal via the scaler.
 - Yes – No video processing (the video scaler is bypassed).

The Bypass mode is set.

Adjusting the Picture

The picture parameters can be adjusted depending on the input type.

To Adjust the picture:

1. In the Navigation pane, click **Output Settings**. The Settings page appears.
2. Use the sliders under Picture to adjust contrast, brightness, colors (red, green, and blue), Hue Saturation and Sharpness.



For HDMI and CV inputs all picture adjustments are available. For the VGA input, hue, saturation and sharpness are disabled.

3. Open the Noise Reduction drop-down box to define the video noise reduction.



Figure 21: Output Settings Page – Noise Reduction

Picture is adjusted.

Finetuning the Image

If the VGA input is selected, you can fine tune the image.

To finetune the image:

1. In the Navigation pane, click **Output Settings**. The Output Settings page appears.
2. Click **Auto Adjust** to automatically adjust the image.
3. Use the sliders to adjust the phase, clock, H-Position, and V-Position.

VGA image is defined.

Managing HDCP

Use the HDCP page to define the encryption on the inputs and outputs.

To manage HDCP:

1. In the Navigation pane, click **HDCP**. The HDCP page appears.

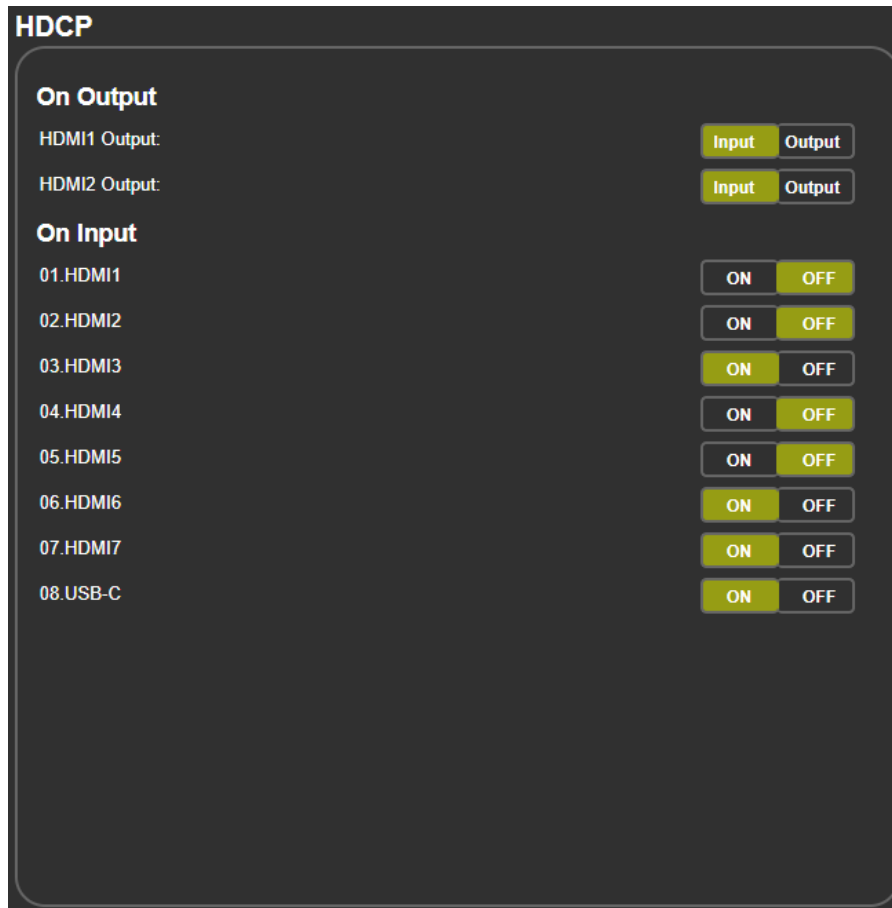

Figure 22: HDCP Page

2. Do these actions:

- Set the HDMI outputs to follow **Input** or **Output**.
- Set HDCP on each HDMI and the USB-C input separately to **ON** or **OFF**.

HDCP is defined.

Managing EDID

Acquire the EDID from the outputs (HDMI), or from a pre-defined 1080p or 4K timing for HDMI or PC.

To acquire EDID:

1. In the Navigation pane, click **EDID**. The EDID page appears.

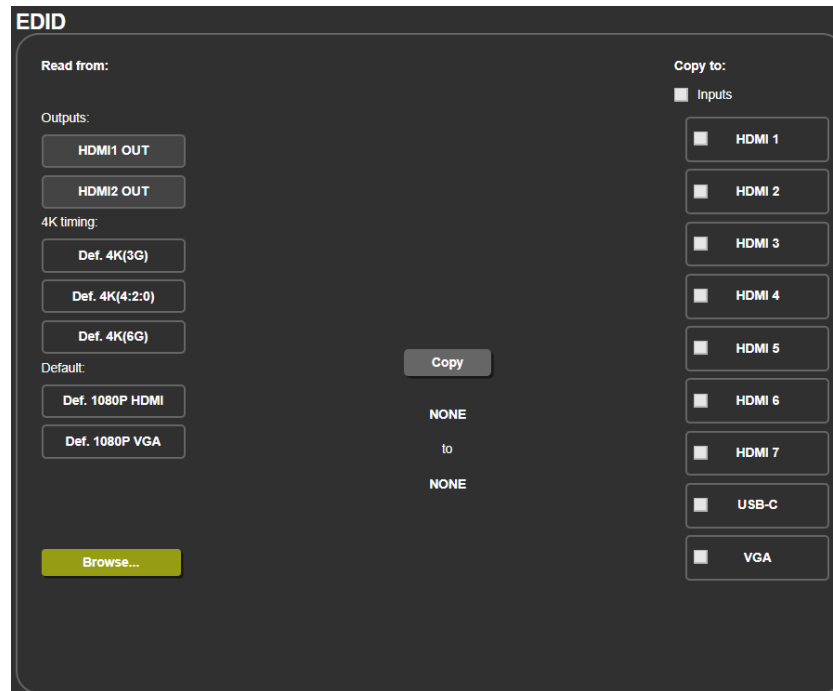

Figure 23: EDID Page

2. In the **Read from** area on the left, click the required EDID source (outputs, timing, or defaults), or click **Browse** to use an external EDID configuration File.
3. In the **Copy to** area on the right, click the input(s) to which to copy the selected EDID. The Copy button is enabled.
4. Click **Copy**.

The selected EDID is copied to the selected inputs and the Copy EDID Results message appears.



Figure 24: EDID Page –Copy EDID Results

5. Click **Close**.

EDID is acquired.

Setting Audio Parameters

VP-550X enables setting the audio delay time and performing the following functions:

- [Setting Input Source and Volume](#) on page 35.
- [Adjusting Microphone Settings](#) on page 36.
- [Configuring Additional Audio Settings](#) on page 36.

To set the microphone and output volumes, see [Setting the Volume](#) on page 27.

Setting Input Source and Volume

To set the input volume:

1. In the Navigation pane, click **Audio**. The Audio Settings page appears.



Figure 25: Audio Settings Page

2. For each input, set the volume by:
 - Entering the value in the text box next to the input name.
 - Sliding the volume switch.

The volume is set.

To set the input audio source:

1. In the Navigation pane, click **Audio Settings**. The Audio Settings page appears (see [Figure 25](#)).
2. For each HDMI input, select the audio source (Automatic, Analog or Embedded) from the drop-down box.

The input source is selected.

Adjusting Microphone Settings

To adjust microphone settings:

1. In the Navigation pane, click **Audio Settings**. The Audio Settings page appears (see [Figure 25](#)).
2. Under Mic Settings you can do the following:
 - Open the Mic Mode drop-down box and select the microphone mode.
 - Select **Mic**.
3. When Mic mode is set to **Talkover**, set the Depth, Trigger, Attack time, Hold time, and Release time by:
 - Entering the value in the text box next to the input name.
 - Sliding the volume switch.



For further details, see [Talkover Mode](#) on page [14](#).

Microphone is set.

Configuring Additional Audio Settings

You can configure other audio parameters under the Settings area.

To configure additional audio settings:

1. In the Navigation pane, click **Audio Settings**. The Audio Settings page appears.
2. Under Settings you can do the following:
 - Set DRC (Dynamic Range Compression) to **On** or **Off** (default).
 - Adjust the Bass and Treble by:
 - Entering the value in the text box next to the input name.
 - Sliding the volume switch.
 - Set Loudness to **On** or **Off** (default).
 - Apply **DSP** (default) to the embedded audio or **Bypass** it.

Audio setting are set.

Setting the RS-232 Port Function

Use the RS-232 page to define the function of the RS-232 CTRL OUT port (22) on the VP-550X rear panel.

To set the RS-232 port function:

1. In the Navigation pane, click **RS-232**. The RS-232 page appears.

RS-232

Use RS-232 CONTROL OUT Port for RS-232 tunneling via Ethernet

RS-232 control of External Device

RS-232 configuration

Baud Rate:

Data Bits:

Parity:

Stop Bits:

Tunneling Port: Port Set

External Device commands configuration

Command	Description	Trigger	Delay(sec)	Hex	Enable
<input type="text"/>	<input type="text"/>	<input type="text" value="5V On"/>	<input type="text" value="30"/>	<input type="checkbox"/>	<input type="checkbox"/>

Add

Figure 26: RS-232 Page – Control the Device Setting

2. In the Use RS-232 Control Port for drop down list, select one of the port options:
 - Control of EXTERNAL DEVICE – see [Controlling an External Device](#) on page 38.
 - RS-232 tunneling via Ethernet – see [Tunneling via Ethernet](#) on page 40.

RS-232 is set.

Controlling an External Device

When Control of EXTERNAL DEVICE is selected, you can set **VP-550X** to automatically send RS-232 commands to an external device that is connected to one of the outputs. For example, to turn off a projector when no video signal is detected on the **VP-550X** input.

To configure commands to send to an external device:

1. In the Navigation pane, click **RS-232**. The Audio RS-232 page appears.
2. Set RS-232 Control to Control of EXTERNAL DEVICE:

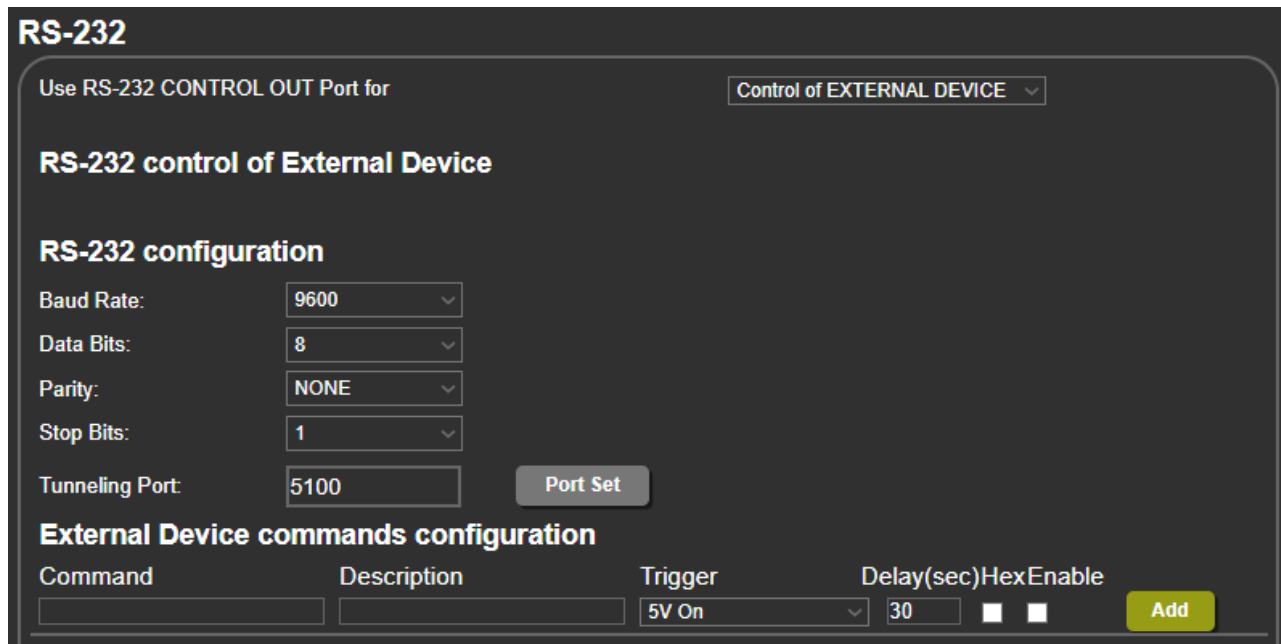

RS-232

Use RS-232 CONTROL OUT Port for Control of EXTERNAL DEVICE ▾

RS-232 control of External Device

RS-232 configuration

Baud Rate: ▾

Data Bits: ▾

Parity: ▾

Stop Bits: ▾

Tunneling Port:

External Device commands configuration

Command	Description	Trigger	Delay(sec)	Hex	Enable
<input type="text"/>	<input type="text"/>	<input type="text" value="5V On"/> ▾	<input type="text" value="30"/>	<input type="checkbox"/>	<input type="checkbox"/>

Figure 27: RS-232 Page – Controlling an External Device

3. Under RS-232 Configuration set the RS-232 port parameters to enable communication with the acceptor.
4. Configure the commands as follows:
 - Enter the device command (for example, PWR OFF).
 - Enter the command description.
 - Select a trigger from the drop-down box which will activate the command (**5V On**, **5V Off**, **Sync/Clock** or **No Sync/No Clock**).
 - Enter a delay time, if required.
 - Check Hex to view the Hex format, if required.
 - To enable the command, select the **Enable** checkbox.

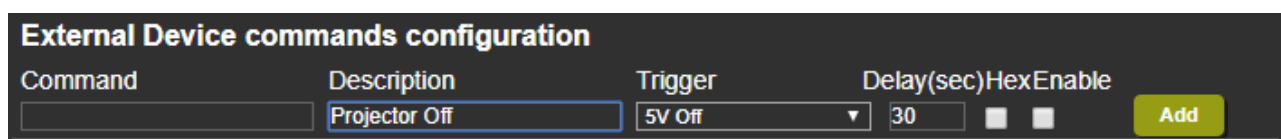

External Device commands configuration

Command	Description	Trigger	Delay(sec)	Hex	Enable
<input type="text"/>	<input type="text" value="Projector Off"/>	<input type="text" value="5V Off"/> ▾	<input type="text" value="30"/>	<input type="checkbox"/>	<input type="checkbox"/>

Figure 28: RS-232 – Creating a Command

5. Click **Add**.

Command	Description	Trigger	Delay(sec)	Hex	Enable	
		5V Off	30	<input type="checkbox"/>	<input type="checkbox"/>	<input type="button" value="Add"/>
43 30 30 0D	Projector Off	5V Off	30	<input type="checkbox"/>	<input type="checkbox"/>	<input type="button" value="Delete"/> <input type="button" value="Test"/>

Figure 29: RS-232 Page – Command Added

6. Optionally, do any of the following:
 - Click **Delete** to delete the command.
 - Click **Test** to test the command.
 - Change any of the command configurations.
 - Enable or disable the command.

Commands are configured to be sent to an external device.

Tunneling via Ethernet

When RS-232 tunneling via Ethernet is selected, you can send commands via Ethernet, allowing embedded RS-232 data tunneling between the Ethernet port and the RS-232 CTRL-OUT port.

To send commands to the HDMI acceptor:

1. In the Navigation pane, click **RS-232**. The Audio RS-232 page appears.
2. Set RS-232 Control to **RS-232 tunneling via Ethernet**:

The screenshot shows the RS-232 configuration interface. At the top, it says 'Use RS-232 CONTROL OUT Port for' with a dropdown menu set to 'RS-232 tunneling via Ethernet'. Below this is the 'RS-232 control of External Device' section, which includes 'RS-232 configuration' with fields for Baud Rate (9600), Data Bits (8), Parity (NONE), Stop Bits (1), and Tunneling Port (5100). A 'Port Set' button is next to the Tunneling Port field. Below that is the 'External Device commands configuration' section, which is a table with columns for Command, Description, Trigger, Delay(sec), and HexEnable. The table contains one entry: Command '43 30 30 0D', Description 'Projector Off', Trigger '5V On', Delay '30', and HexEnable '■ ■'. There are 'Add', 'Delete', and 'Test' buttons associated with the table entries.

Figure 30: RS-232 Page – Tunneling via Ethernet

3. Under RS-232 Configuration set the RS-232 port parameters to enable communication with the acceptor.
4. Enter the Tunneling Port and click **Port Set**.

Tunneling via Ethernet is set.

Setting Web Page Access

By default, the web pages are secured and require access permission (User Name and Password are both: **Admin**). This section describes how to change the password and disable/enable access permission.

To change the password:

1. In the Navigation pane, click **Authentication**. The Authentication page appears.

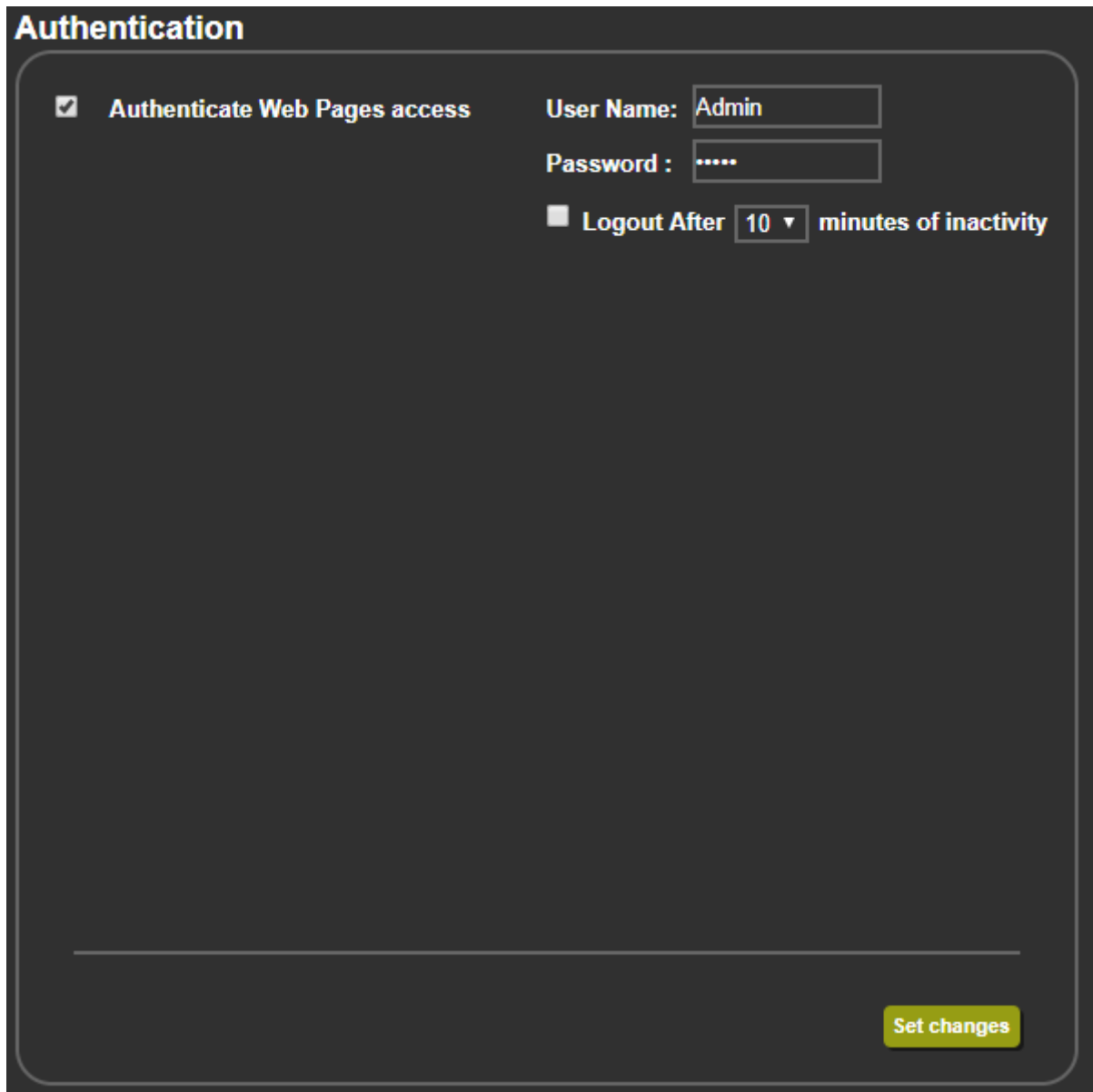

The screenshot shows the 'Authentication' configuration page. It features a dark background with white text. At the top left, the title 'Authentication' is displayed. Below it, there is a checked checkbox labeled 'Authenticate Web Pages access'. To the right of this checkbox, there are two input fields: 'User Name:' containing the text 'Admin' and 'Password:' containing six dots. Below these fields, there is an unchecked checkbox labeled 'Logout After' followed by a dropdown menu showing '10' and the text 'minutes of inactivity'. At the bottom right of the form area, there is a yellow button with the text 'Set changes'.

Figure 31: Authentication Page

2. Enter the new password.

3. Click **Set changes**.

The following message appears:

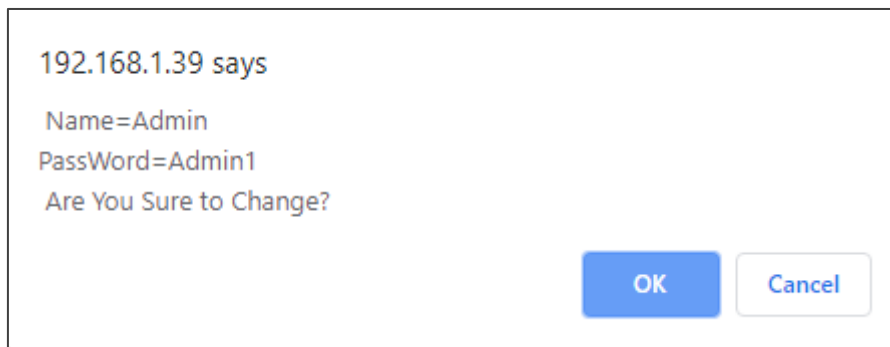

Figure 32: Authentication Page – Changing the Name/Password

4. Click **OK**.

The following message appears:

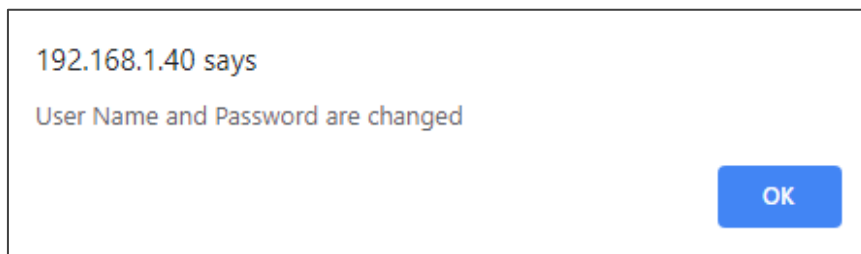

Figure 33: Authentication Page – Password Change Confirmation

5. Click **OK**.

Username and password have changed.

6. Reenter the webpages.



Figure 34: Authentication Page – Password Authentication

7. Click arrow.

The webpage reloads.

To disable security:

1. In the Navigation pane, click **Authentication**. The Authentication page appears.
2. Uncheck **Authenticate Web Pages access**.

3. Click **Set changes**

The following message appears:



Figure 35: Authentication Page – Security Disable Confirmation

4. Click **OK**.

Authentication is not required.

To enable security:

1. In the Navigation pane, click **Security**. The Security page appears.

2. Check **Authenticate Web pages Access**.

Previous credentials are restored.

3. Click **Set changes**.

The following message appears:



Figure 36: Security – Security Enable Confirmation

4. Click **OK**.

 Appears

Authentication is now required.

Defining Auto Sync Off

Define auto sync off when signal is lost (also can be set via the OSD menu, see [Setting Sleep Mode](#) on page 16).

To define auto sync off:

1. In the Navigation pane, click **Advanced**. The Advanced page appears.

Advanced

Auto Sync Off Disable ▾
Time taken to turn off the sync when the signal is lost

Auto Switching Off ▾

Lock Mode Menu Only ▾
Select which front panel buttons are to be locked

System Status

Power Supply 1	PASS	24.05	V	0.41	A
Power Supply 2	PASS	4.99	V	0.33	A
Power Supply 3	PASS	4.96	V	0.64	A
Power Supply 4	PASS	4.96	V	0.46	A
Power Supply 5	PASS	3.27	V	0.33	A
Temperature 1	PASS	32.7		37	°C
Temperature 2	PASS			40	°C
Temperature 3	PASS			39	°C
Temperature 4	PASS			39	°C
Temperature 5	PASS			40	°C
Temperature 6	PASS			40	°C
Temperature 7	PASS			35	°C
Temperature 8	PASS			-1	°C
FAN 1	PASS				
FAN 2	PASS				

Figure 37: Advanced Page

2. In the Auto Sync Off drop-down box, select the sync mode (**Disable**, **Slow**, **Fast**, or **Immediate**).

Auto Sync Off Disable ▾
Time taken to turn off the sync when the signal is lost

Auto Switching

- Disable
- Fast
- Slow
- Immediate

Figure 38: Advanced Page – Defining Auto Sync Off

Auto Sync Off mode is set.

Defining Auto Switching Mode

Define auto switching mode (also can be set via the OSD menu, see [Setting Switching Mode](#) on page [16](#)).

To define auto switching mode:

1. In the Navigation pane, click **Advanced**. The Advanced page appears.
2. Next to Auto Switching, open the drop-down box to select the switching mode (Off (manual), Auto Scan or Last Connected).



Figure 39: Advanced Page – Defining Switching Mode

Auto Switching Mode is set.

Defining Lock Mode

Define lock mode (also can be set via the OSD menu, see [Setting Lock Mode Functionality](#) on page [17](#)).

To define Lock mode:

1. In the Navigation pane, click **Advanced**. The Advanced page appears.
2. Next to Lock Mode, open the drop-down box to select the lock mode (All, Menu Only, All & Save or Menu Only & Save).

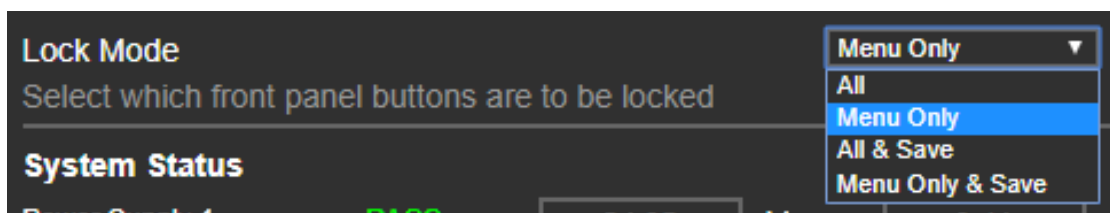

Figure 40: Advanced Page – Defining Lock Mode

Lock mode is set.

Hardware Diagnostics

System Status in the Advanced page shows the device hardware status. If hardware failure occurs or any of the parameters exceed their limits, system status indicates the problem.

To view system status:

1. In the Navigation pane, click **Advanced**. The Advanced page appears.
2. In System Status area, view power supply, temperature, and fan indicators.

The screenshot shows the 'Advanced' configuration page with the 'System Status' section expanded. The status for all components is 'PASS'. The power supply section shows five units with their respective voltage and current readings. The temperature section shows eight sensors with their current readings in degrees Celsius.

Component	Status	Value 1	Unit 1	Value 2	Unit 2
Power Supply 1	PASS	24.05	V	0.41	A
Power Supply 2	PASS	4.99	V	0.33	A
Power Supply 3	PASS	4.96	V	0.64	A
Power Supply 4	PASS	4.96	V	0.46	A
Power Supply 5	PASS	3.27	V	0.33	A
Temperature 1	PASS	32.7		37	°C
Temperature 2	PASS			40	°C
Temperature 3	PASS			39	°C
Temperature 4	PASS			39	°C
Temperature 5	PASS			40	°C
Temperature 6	PASS			40	°C
Temperature 7	PASS			35	°C
Temperature 8	PASS			-1	°C
FAN 1	PASS				
FAN 2	PASS				

Figure 41: Advanced Page – System Status

System Status shows.

Viewing Device Information

In the Navigation page, open the About page to view the webpage version and Kramer Electronics details.



Figure 42: About Page

Upgrading the Firmware

Upgrade the firmware via the webpages (see [Updating the Firmware](#) on page 28).

For more information about Kramer firmware updates, go to [Software Firmware Updates](#).

Technical Specifications

Inputs	7 HDMI:	On female HDMI connectors
	1 USB (providing power): connector	On a USB type-C connector
	1 Computer Graphics:	On a 15-pin HD connector
	1 Composite Video:	On an RCA connector
	3 Unbalanced Stereo Analog Audio (AUX, VGA and CV):	On 3-pin terminal blocks
	Microphone:	On a 3-pin terminal block
Outputs	2 HDMI:	On female HDMI connectors
	1 Balanced Analog Stereo Audio:	On a 5-pin terminal block
Ports	1 RS-232 (Data):	On a 3-pin terminal block
	1 RS-232 (Control):	On a 3-pin terminal block
	1 Ethernet:	On an RJ-45 connector
Video	Input HDMI and USB-C Resolutions:	480i/576i, 480p/576p, 640x480@60/72/75/85Hz, 720p@60/50Hz, 800x600@56/60/72/75Hz, 1024x768@60/70/75Hz, 1080i@60/50Hz, 1080p@24/25/30Hz, 1080p@60/50Hz, 1280x1024@60/75Hz, 1280x720@60Hz, 1280x768@60Hz, 1280x800@60Hz, 1280x960@60Hz, 1360x768@60Hz, 1366x768@60Hz, 1400x1050@60Hz, 1600x1200@60Hz, 1600x900@60Hz RB, 1680x1050@60Hz, 1920x1080@60Hz, 1920x1200@60Hz RB, 4K2K@50/60Hz (4:2:0), 4K2K@24/25/30/50/60Hz (4:4:4),
	Input Computer Graphics Resolutions:	640x480@60/72/75/85Hz, 800x600@56/60/72/75Hz, 1024x768@60/70/75Hz, 1280x1024@60/75Hz, 1280x960@60Hz, 1280x720@60Hz, 1280x768@60Hz, 1280x800@60Hz, 1360x768@60Hz, 1366x768@60Hz, 1400x1050@60Hz, 1600x1200@60Hz, 1680x1050@60Hz, 1920x1080@60Hz, 1920x1200@60Hz RB
	Input CV Resolution:	480i/576i
	Output HDMI Resolutions:	480p@60Hz, 576p@50Hz, 720p@50/60Hz, 1080p@24/25/30/50/60Hz, 640x480@60Hz, 800x600@60Hz, 1024x768@60Hz, 1280x768@60Hz, 1280x720@60Hz, 1280x800@60Hz, 1280x1024@60Hz, 1360x768@60Hz, 1400x1050@60Hz, 1440x900@60Hz, 1600x1200@60Hz, 1680x1050@60Hz, 1920x1080@60Hz, 1920x1200@60Hz RB, 4K/2K@50/60Hz (4:2:0), 4K/2K@24/25/30/50/60Hz (4:4:4)

	Max. Resolution – HDMI and USB-C:	4K@60Hz (4:4:4)
	Max. Input Resolution – VGA:	1080p60 / UXGA
	Content Protection:	Up to HDCP 2.2
	HDMI Support:	HDR10, CEC, xvYCC color (on input), Dolby TrueHD/DTS-HD Master Audio (by-pass), as specified in HDMI 2.0 Latency: 1-2 frames
	Latency	1-2 frames
User Interface	Controls:	IR remote, Input selection, freeze, mute, XGA/1080p reset, and panel lock buttons, OSD menu
	Indicators:	IR, selected input LEDs
Power	Source:	100-240V AC 50/60Hz
	Consumption:	1A
Enclosure	Size:	19"
	Type:	Aluminum
	Cooling:	Convection ventilation
Environmental Conditions	Operating Temperature:	0° to +40°C (32° to 104°F)
	Storage Temperature:	-40° to +70°C (-40° to 158°F)
	Humidity:	10% to 90%, RHL non-condensing
Regulatory Compliance (Standards Compliance)	Standards:	CE, FCC
Accessories	Included:	Power cord, rubber feet, rack ears, IR remote control with batteries
Product Dimensions	43.64cm x 23.72cm x 4.36cm (17.18" x 9.34" x 1.72") W, D, H	
Product Weigh	2.0kg (4.5lbs) approx.	
Shipping Dimensions	55.00cm x 33.00cm x 10.70cm (21.65" x 12.99" x 4.21") W, D, H	
Shipping Weight	3.0kg (6.5lbs) approx.	

Default Communication Parameters

RS-232	
Baud Rate:	115,200
Data Bits:	8
Stop Bits:	1
Parity:	None
Command Format:	ASCII
Example (Route the video HDMI2 input to the output ports):	#ROUTE 1,1,2<CR>
Ethernet	
To reset the IP settings to the factory reset values go to: Menu > Setup > Factory Reset > press Enter to confirm.	
IP Address:	192.168.1.39
Subnet mask:	255.255.0.0
Default gateway:	192.168.0.1
TCP Port #:	5000
UDP Port #:	50000
Default Username / Password:	Admin / Admin
Number of TCP clients	4
Number of UDP clients	2
Full Factory Reset	
OSD	Go to: Menu > Factory > RESET > YES and press Enter.

Input Resolutions Support

VP-550X supports the following input resolutions.

HDMI Input Resolutions

480i/576i	480p/576p	1080i @60/50Hz
720p @60/50Hz	1080p @60/50Hz	1080p @24/25/30Hz
640x480 @60/72/75/85Hz	800x600 @56/60/72/75Hz	1024x768 @60/70/75Hz
1280x1024 @60/75Hz	1280x960 @60Hz	1280x720 @60Hz
1920x1080 @60Hz	1600x1200 @60Hz	1280x768 @60Hz
1280x800 @60Hz	1360x768 @60Hz	1366x768 @60Hz
1400x1050 @60Hz	1600x900 @60Hz RB	1680x1050 @60Hz
1920x1200 @60Hz RB	4K2K @50/60Hz (4:2:0)	4K2K @24/25/30/50/60Hz (4:4:4)

Computer Graphics Input Resolutions

640x480 @60/72/75/85Hz	800x600 @56/60/72/75Hz	1024x768 @60/70/75Hz
1280x1024 @60/75Hz	1280x960 @60Hz	1280x720 @60Hz
1920x1080 @60Hz	1600x1200 @60Hz	1280x768 @60Hz
1280x800 @60Hz	1360x768 @60Hz	1366x768 @60Hz
1400x1050 @60Hz	1680x1050 @60Hz	1920x1200 @60Hz RB

CV Input Resolution

480i/576i

Output Resolution Support

VP-550X supports the following output resolutions.

HDMI Output Resolutions

640x480@60Hz	800x600@60Hz	1024x768@60Hz
1280x768@60Hz	1360x768@60Hz	1280x720@60Hz
1280x800@60Hz	1280x1024@60Hz	1440x900@60Hz
1400x1050@60Hz	1680x1050@60Hz	1600x1200@60Hz
1920x1080@60Hz	1920x1200@60Hz RB	2560x1600
2560x1440	480p@60Hz	576p@50Hz
720p@50/60Hz	1080p@24/25/30/50/60Hz	2560x1440@60Hz RB
2560x1600@60Hz RB	4K/2K@50/60Hz (4:2:0)	4K@24/25/30/50/60Hz (4:4:4)
Native		

Default EDID

Monitor

Model name..... VP-550X

Manufacturer..... KMR

Plug and Play ID..... KMR061D

Serial number..... 49

Manufacture date..... 2018, ISO week 6

Filter driver..... None

EDID revision..... 1.3

Input signal type..... Digital

Color bit depth..... Undefined

Display type..... Monochrome/grayscale

Screen size..... 310 x 170 mm (13.9 in)

Power management..... Standby, Suspend

Extension blocs..... 1 (CEA/CTA-EXT)

DDC/CI..... n/a

Color characteristics

Default color space..... Non-sRGB

Display gamma..... 2.40
 Red chromaticity..... Rx 0.611 - Ry 0.329
 Green chromaticity..... Gx 0.313 - Gy 0.559
 Blue chromaticity..... Bx 0.148 - By 0.131
 White point (default).... Wx 0.320 - Wy 0.336
 Additional descriptors... None

Timing characteristics

Horizontal scan range.... 15-136kHz
 Vertical scan range..... 23-61Hz
 Video bandwidth..... 600MHz
 CVT standard..... Not supported
 GTF standard..... Not supported
 Additional descriptors... None
 Preferred timing..... Yes
 Native/preferred timing.. 3840x2160p at 60Hz (16:9)
 Modeline..... "3840x2160" 594.000 3840 4016 4104 4400 2160 2168 2178 2250 +hsync +vsync
 Detailed timing #1..... 1920x1080p at 60Hz (16:9)
 Modeline..... "1920x1080" 148.500 1920 2008 2052 2200 1080 1084 1089 1125 +hsync +vsync

Standard timings supported

640 x 480p at 60Hz - IBM VGA
 640 x 480p at 72Hz - VESA
 640 x 480p at 75Hz - VESA
 800 x 600p at 56Hz - VESA
 800 x 600p at 60Hz - VESA
 800 x 600p at 72Hz - VESA
 800 x 600p at 75Hz - VESA
 1024 x 768p at 60Hz - VESA
 1024 x 768p at 70Hz - VESA
 1024 x 768p at 75Hz - VESA
 1280 x 1024p at 75Hz - VESA

1600 x 1200p at 60Hz - VESA STD
 1280 x 1024p at 60Hz - VESA STD
 1400 x 1050p at 60Hz - VESA STD
 1920 x 1080p at 60Hz - VESA STD
 640 x 480p at 85Hz - VESA STD
 800 x 600p at 85Hz - VESA STD
 1024 x 768p at 85Hz - VESA STD
 1280 x 1024p at 85Hz - VESA STD

EIA/CEA/CTA-861 Information

Revision number..... 3
 IT underscan..... Supported
 Basic audio..... Supported
 YCbCr 4:4:4..... Supported
 YCbCr 4:2:2..... Supported
 Native formats..... 0
 Detailed timing #1..... 1440x900p at 60Hz (16:10)
 Modeline..... "1440x900" 106.500 1440 1520 1672 1904 900 903 909 934 -hsync +vsync
 Detailed timing #2..... 1366x768p at 60Hz (16:9)
 Modeline..... "1366x768" 85.500 1366 1436 1579 1792 768 771 774 798 +hsync +vsync
 Detailed timing #3..... 1920x1200p at 60Hz (16:10)
 Modeline..... "1920x1200" 154.000 1920 1968 2000 2080 1200 1203 1209 1235 +hsync -vsync

CE video identifiers (VICs) - timing/formats supported

1920 x 1080p at 60Hz - HDTV (16:9, 1:1)
 1920 x 1080p at 50Hz - HDTV (16:9, 1:1)
 1280 x 720p at 60Hz - HDTV (16:9, 1:1)
 1280 x 720p at 50Hz - HDTV (16:9, 1:1)
 1920 x 1080i at 60Hz - HDTV (16:9, 1:1)
 1920 x 1080i at 50Hz - HDTV (16:9, 1:1)
 720 x 480p at 60Hz - EDTV (4:3, 8:9)
 720 x 576p at 50Hz - EDTV (4:3, 16:15)

720 x 480i at 60Hz - Doublescan (4:3, 8:9)

720 x 576i at 50Hz - Doublescan (4:3, 16:15)

1920 x 1080p at 30Hz - HDTV (16:9, 1:1)

1920 x 1080p at 25Hz - HDTV (16:9, 1:1)

1920 x 1080p at 24Hz - HDTV (16:9, 1:1)

1920 x 1080p at 24Hz - HDTV (16:9, 1:1)

1920 x 1080p at 24Hz - HDTV (16:9, 1:1)

1920 x 1080p at 24Hz - HDTV (16:9, 1:1)

1920 x 1080p at 24Hz - HDTV (16:9, 1:1)

1920 x 1080p at 24Hz - HDTV (16:9, 1:1)

NB: NTSC refresh rate = (Hz*1000)/1001

CE audio data (formats supported)

LPCM 2-channel, 16/20/24 bit depths at 32/44/48 kHz

CE speaker allocation data

Channel configuration.... 2.0

Front left/right..... Yes

Front LFE..... No

Front center..... No

Rear left/right..... No

Rear center..... No

Front left/right center.. No

Rear left/right center... No

Rear LFE..... No

CE vendor specific data (VSDB)

IEEE registration number. 0x000C03

CEC physical address..... 1.0.0.0

Supports AI (ACP, ISRC).. No

Supports 48bpp..... Yes

Supports 36bpp..... Yes

Supports 30bpp..... Yes
Supports YCbCr 4:4:4..... Yes
Supports dual-link DVI... No
Maximum TMDS clock..... 300MHz
Audio/video latency (p).. n/a
Audio/video latency (i).. n/a
HDMI video capabilities.. Yes
EDID screen size..... No additional info
3D formats supported..... Not supported
Data payload..... 030C001000783C20008001020304

CE vendor specific data (VSDB)

IEEE registration number. 0xC45DD8
CEC physical address..... 0.1.7.8
Supports AI (ACP, ISRC).. Yes
Supports 48bpp..... No
Supports 36bpp..... No
Supports 30bpp..... No
Supports YCbCr 4:4:4..... No
Supports dual-link DVI... No
Maximum TMDS clock..... 35MHz

YCbCr 4:2:0 capability map data

Data payload..... 0F000003

Protocol 3000

Kramer devices can be operated using Kramer Protocol 3000 commands sent via serial or Ethernet ports.

Understanding Protocol 3000

Protocol 3000 commands are a sequence of ASCII letters, structured according to the following.

- **Command format:**

Prefix	Command Name	Constant (Space)	Parameter(s)	Suffix
#	Command	_	Parameter	<CR>

- **Feedback format:**

Prefix	Device ID	Constant	Command Name	Parameter(s)	Suffix
~	nn	@	Command	Parameter	<CR><LF>

- **Command parameters** – Multiple parameters must be separated by a comma (.). In addition, multiple parameters can be grouped as a single parameter using brackets ([and]).
- **Command chain separator character** – Multiple commands can be chained in the same string. Each command is delimited by a pipe character (|).
- **Parameters attributes** – Parameters may contain multiple attributes. Attributes are indicated with pointy brackets (<...>) and must be separated by a period (.).

The command framing varies according to how you interface with the **VP-550X**. The following figure displays how the # command is framed using terminal communication software (such as Hercules):

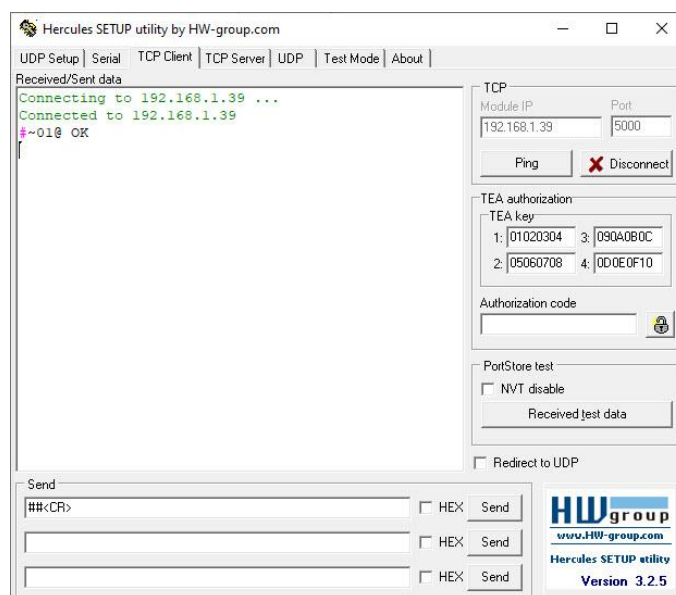

Protocol 3000 Commands

Function	Description	Syntax	Parameters/Attributes	Example
#	Protocol handshaking.  Validates the Protocol 3000 connection and gets the machine number. Step-in master products use this command to identify the availability of a device.	COMMAND #<CR> FEEDBACK ~nn@_OK<CR><LF>		#<CR>
AUD-EMB	Set audio in video embedding status.	COMMAND #AUD-EMB_in,out,status<CR> FEEDBACK ~nn@AUD-EMB_in,out,status<CR><LF>	in – Audio input to be embedded number 0 = HDMI 1 1 = HDMI 2 2 = HDMI 3 3 = HDMI 4 4 = HDMI 5 5 = HDMI 6 6 = HDMI 7 7 = USB-C out = 0 status – Embedding status 0 = Analog 1 = Embedded 2 = Auto	Set audio in video embedding status for input 3 to analog: #AUD-EMB?_7,0,1<CR>
AUD-EMB?	Get audio in video embedding status.	COMMAND #AUD-EMB_in,out,<CR> FEEDBACK ~nn@AUD-EMB_in,out,status<CR><LF>	in – Audio input to be embedded number 0 = HDMI 1 1 = HDMI 2 2 = HDMI 3 3 = HDMI 4 4 = HDMI 5 5 = HDMI 6 6 = HDMI 7 7 = USB-C out = 0 status – Embedding status 0 = Analog 1 = Embedded 2 = Auto	Get audio in video embedding status for input 3 to the output: #AUD-EMB?_2,0<CR>
AUDIO-BYPASS	Set audio bypass status.	COMMAND #AUDIO-BYPASS_status<CR> FEEDBACK #AUDIO-BYPASS_status<CR>	status – On/Off 0 = Off 1 = On	Set audio-bypass to off: #AUDIO-BYPASS_0<CR>
AUDIO-BYPASS?	Get audio bypass status.	COMMAND #AUDIO-BYPASS?_<CR> FEEDBACK #AUDIO-BYPASS?_status<CR><LF>	status – On/Off 0 = Off 1 = On	Get audio bypass status: #AUDIO-BYPASS?_<CR>
AUD-LVL	Set volume level.	COMMAND #AUD-LVL_stage,channel,volume<CR> FEEDBACK ~nn@AUD-LVL_stage,channel,volume<CR><LF>	stage – Input/Output 0 = Input 1 = Output 2 = Line level channel – For Input: 0 = HDMI 1 1 = HDMI 2 2 = HDMI 3 3 = HDMI 4 4 = HDMI 5 5 = HDMI 6 6 = HDMI 7 7 = USB-C 8 = VGA 9 = CV For Output 0 = Line Output 1 = Speaker volume – Volume level 0 to 100; ++ (increase current value by 1dB); -- (decrease current value by 1dB)	Set AUDIO PC input level to 50: #AUD-LVL_1,0,50<CR>

Function	Description	Syntax	Parameters/Attributes	Example
AUD-LVL?	Get volume level.	COMMAND #AUD-LVL?_stage,channel<CR> FEEDBACK ~nn@AUD-LVL_ stage,channel,volume<CR><LF>	stage – Input/Output 0 = Input 1 = Output 2 = Line level channel – For Input: 0 = HDMI 1 1 = HDMI 2 2 = HDMI 3 3 = HDMI 4 4 = HDMI 5 5 = HDMI 6 6 = HDMI 7 7 = USB-C 8 = VGA 9 = CV For Output 0 = Line Output volume – Volume level 0 to 100;	Get Speaker audio level #AUD-LVL?_1,1<CR>
AV-SW-MODE	Set input auto switch mode (per output)	COMMAND #AV-SW-MODE_layer,output_id,mode<CR> FEEDBACK c#AV-SW-MODE_layer,output_id,mode<CR>	layer – Layer Enumeration 1 output_id – 1 mode – 0 – manual 1 – priority switch 2 – last connected switch	Set input auto switch mode (per output) for audio 1 to manual: #AV-SW-MODE_1,1,0<CR>
AV-SW-MODE?	Get input auto switch mode (per output)	COMMAND #AV-SW-MODE?_layer,output_id<CR> FEEDBACK ~nn@AV-SW-MODE_layer,output_id,mode<CR><LF>	layer – Layer Enumeration 1 outputs_id – 1 mode – 0 – manual 1 – priority switch 2 – last connected switch	Get input auto switch mode (per output) for audio 1 to manual: #AV-SW-MODE?_1,1<CR>
BUILD-DATE?	Get device build date.	COMMAND #BUILD-DATE?_<CR> FEEDBACK ~nn@BUILD-DATE_date,time<CR><LF>	date – Format: YYYY/MM/DD where YYYY = Year MM = Month DD = Day time – Format: hh:mm:ss where hh = hours mm = minutes ss = seconds	Get the device build date: #BUILD-DATE?<CR>
CEC ON/OFF	Sets the device's CEC state to ON or OFF	COMMAND #CEC_state<CR> FEEDBACK ~nn@CEC_state<CR><LF>	state – CEC state Off On	Set CEC state to on: #CEC_ON<CR>
CPEDID	Copy EDID data from the output to the input EEPROM. <i>i</i> Destination bitmap size depends on device properties (for 64 inputs it is a 64-bit word). Example: bitmap 0x0013 means inputs 1,2 and 5 are loaded with the new EDID. In certain products Safe_mode is an optional parameter. See the HELP command for its availability.	COMMAND #CPEDID_edid_io,src_id,edid_io,dest_bitmap<CR> or #CPEDID_edid_io,src_id,edid_io,dest_bitmap,safe_mode<CR> FEEDBACK ~nn@CPEDID_edid_io,src_id,edid_io,dest_bitmap<CR><LF> ~nn@CPEDID_edid_io,src_id,edid_io,dest_bitmap,safe_mode<CR><LF>	edid_io – EDID source type (usually output) 0 = Input 1 = Output 2 = Default EDID 3 = Custom EDID src_id – Number of chosen source stage 0 = Default EDID source 1 = Output 1 2 = Output 2 edid_io – EDID destination type (usually input) 0 = Input 1 = Output 2 = Default EDID 3 = Custom EDID dest_bitmap – Bitmap representing destination IDs. Format: XXXX..X, where X is hex digit. The binary form of every hex digit represents corresponding destinations. 0 = indicates that EDID data is not copied to this destination. 1 = indicates that EDID data is copied to this destination. safe_mode – Safe mode 0 = device accepts the EDID as is without trying to adjust 1 = device tries to adjust the EDID (default value if no parameter is sent)	Copy the EDID data from the Output 1 (EDID source) to the Input: #CPEDID_1,1,0,0x1<CR> Copy the EDID data from the default EDID source to the Input: #CPEDID_2,0,0,0x1<CR>
DISPLAY?	Get output HPD status.	COMMAND #DISPLAY?_out_id<CR> FEEDBACK ~nn@DISPLAY_out_id,status<CR><LF>	out_id – Output number 1 = HDMI 1 2 = HDMI 2 status – HPD status according to signal validation 0 = Signal or sink is not valid 1 = Signal or sink is valid 2 = Sink and EDID is valid	Get the output HPD status of the HDMI2 output: #DISPLAY?_2<CR>
EQ-LVL	Set equalization level.	COMMAND #EQ-LVL_Stage,Channel,EqType,Level<CR> FEEDBACK ~nn@EQ-LVL_Stage,Channel,EqType,Level<CR><LF>	Stage – Input / Output 0 – Input 1 – Output Channel – Number of channel EqType – Equalizer Types 0 – Bass 1 – Middle 2 – Treble Level – Equalizer level (±15DB for the PA-120Z project)	Set Bass EQ level of the speaker output to 12: #EQ-LVL_1,1,0,12<CR>

Function	Description	Syntax	Parameters/Attributes	Example
EQ-LVL?	Set equalization level.	COMMAND #EQ-LVL?_Stage, Channel, EqType<CR> FEEDBACK ~nn@EQ-LVL_Stage, Channel, EqType, Level<CR><LF>	Stage – Input / Output 0 – Input 1 – Output Channel – Number of channel EqType – Equalizer Types 0 – Bass 1 – Middle 2 – Treble Level – Equalizer level (±15DB for the PA-120Z project)	Get Bass EQ level of the speaker output to 12: #EQ-LVLV_1, 2, 2<CR>
ETH-PORT	Set Ethernet port protocol. <i>i</i> If the port number you enter is already in use, an error is returned. The port number must be within the following range: 0-(2 ¹⁶ -1).	COMMAND #ETH-PORT_portType, port_id<CR> FEEDBACK ~nn@ETH-PORT_portType, port_id<CR><LF>	portType – TCP/UDP Port_id – TCP/UDP port number TCP – (5000-5099) UDP – (50000-50999)	Set TCP port number to 5000: #ETH-PORT_TCP, 5000<CR>
ETH-PORT?	Get Ethernet port protocol.	COMMAND #ETH-PORT?_port_type<CR> FEEDBACK ~nn@ETH-PORT_port_type, port_id<CR><LF>	port_type – TCP/UDP port_id – when port_type = TCP: 5000-5099 when port_type = UDP: 50000-50999	Get the Ethernet port number for UDP: #ETH-PORT?_UDP<CR>
FACTORY	Reset device to factory default configuration. <i>i</i> This command deletes all user data from the device. The deletion can take some time. Your device may require powering off and powering on for the changes to take effect.	COMMAND #FACTORY<CR> FEEDBACK ~nn@FACTORY_OK<CR><LF>		Reset the device to factory default configuration: #FACTORY<CR>
FAN?	Get fan status	COMMAND #FAN?_<CR> FEEDBACK ~nn@FAN_status<CR><LF>	status – 0 = Fail 1 = Pass	Get fan status: #FAN?_<CR>
HDCP-MOD	Set HDCP mode. <i>i</i> Set HDCP working mode on the device input: HDCP supported - HDCP_ON [default]. HDCP not supported - HDCP OFF. HDCP support changes following detected sink - MIRROR OUTPUT. When you define 3 as the mode, the HDCP status is defined according to the connected output in the following priority: OUT 1, OUT 2. If the connected display on OUT 2 supports HDCP, but OUT 1 does not, then HDCP is defined as not supported. If OUT 1 is not connected, then HDCP is defined by OUT 2.	COMMAND #HDCP-MOD_stage, inp_id, mode<CR> FEEDBACK ~nn@HDCP-MOD_stage, inp_id, mode<CR><LF>	stage – Input/Output 0 = Input 1 = Output inp_id – Input number: 1 = HDMI 1 2 = HDMI 2 3 = HDMI 3 4 = HDMI 4 5 = HDMI 5 6 = HDMI 6 7 = HDMI 7 8 = USB-C Output number 1 = HDMI1 2 = HDMI2 mode – HDCP mode Input: 0 = Off 1 = On Output: 2 = Follow input 3 = Follow output	Set the input HDCP-MODE of input HDMI 1 to Off: #HDCP-MOD_0, 1, 0<CR>
HDCP-MOD?	Get HDCP mode. <i>i</i> Set HDCP working mode on the device input: HDCP supported - HDCP_ON [default]. HDCP not supported - HDCP OFF. HDCP support changes following detected sink - MIRROR OUTPUT.	COMMAND #HDCP-MOD?_stage, inp_id<CR> FEEDBACK ~nn@HDCP-MOD_stage, inp_id, mode<CR><LF>	stage – Input/Output 0 = Input 1 = Output inp_id – Input number: 1 = HDMI 1 2 = HDMI 2 3 = HDMI 3 4 = HDMI 4 5 = HDMI 5 6 = HDMI 6 7 = HDMI 7 8 = USB-C Output number 1 = HDMI1 2 = HDMI2 mode – HDCP mode Input: 0 = Off 1 = On Output: 2 = Follow input 3 = Follow output	Get the input HDCP-MODE of input HDMI 1: #HDCP-MOD?_0, 1<CR>

Function	Description	Syntax	Parameters/Attributes	Example
HELP	Get command list or help for specific command.	COMMAND #HELP<CR> #HELP_<command_name><CR> FEEDBACK 1. Multi-line: ~nn@Device_<command_><CR><LF> To get help for command use: HELP (COMMAND_NAME)<CR><LF> ~nn@HELP_<command:><CR><LF> description<CR><LF> USAGE: usage<CR><LF>	command – Name of a specific command	Get the command list: P<CR> To get help for AV-SW-TIMEOUT: HELP_AV-SW-TIMEOUT<CR>
IMAGE-PROP	Set the image size. ⓘ Sets the image properties of the selected scaler.	COMMAND #IMAGE-PROP_<scaler,>status<CR> FEEDBACK ~nn@IMAGE-PROP_<P1, P2...><CR><LF>	scaler = 1 status – Status 0 = Over scan 1 = Full 2 = Best Fit 3 = Pan Scan 4 = Letter Box 5 = Under 2 6 = Under 1 7 = Follow In	Set the image size to Full: #IMAGE-PROP_1,1<CR>
IMAGE-PROP?	Get the image size. ⓘ Gets the image properties of the selected scaler.	COMMAND #IMAGE-PROP?_<P1, ..., P6><CR> FEEDBACK ~nn@IMAGE-PROP_<P1, P2...><CR><LF>	scaler = 1 status – Status 0 = Over scan 1 = Full 2 = Best Fit 3 = Pan Scan 4 = Letter Box 5 = Under 2 6 = Under 1 7 = Follow In	Get the image size: #IMAGE-PROP?_1<CR>
LOCK-FP	Lock the front panel.	COMMAND #LOCK-FP_Lock/Unlock<CR> FEEDBACK ~nn@LOCK-FP_<Lock/Unlock><CR><LF>	Lock/Unlock – On/Off 0 = Off unlocks front panel 1 = On locks front panel	Unlock front panel: #LOCK-FP_0<CR>
LOCK-FP?	Get the front panel lock state.	COMMAND #LOCK-FP?_<CR> FEEDBACK ~nn@LOCK-FP_<Lock/Unlock><CR><LF>	Lock/Unlock – On/Off 0 = Off unlocks front panel 1 = On locks front panel	Get the front panel lock state: #LOCK-FP?<CR>
LOUDNESS	Set audio loudness.	COMMAND #LOUDNESS_<channel, loudness><CR> FEEDBACK ~nn@LOUDNESS_<channel, loudness><CR><LF>	channel = 1 loudness – On/Off 0 = Off 1 = On	Set audio loudness: #LOUDNESS_1,1<CR>
LOUDNESS?	Get audio loudness.	COMMAND #LOUDNESS?_<channel><CR> FEEDBACK ~nn@LOUDNESS_<channel, loudness><CR><LF>	channel = 1 loudness – On/Off 0 = Off 1 = On	Get audio loudness: #LOUDNESS?_1<CR>
MIC-GAIN	Set the microphone gain. ⓘ Sets the microphone input audio gain.	COMMAND #MIC-GAIN_<P1, P2, P3><CR> FEEDBACK ~nn@MIC-GAIN_<P1, P2, P3><CR><LF>	P1 = 0 P1 – Mic number 0 = Mic 1 1 = Mic 2 P3 – Level = 0 to 100 ++ increase current value – decrease current value	Set mic 1 gain to 35: #MIC-GAIN_0,0,35<CR>
MIC-GAIN?	Get the microphone gain. ⓘ Gets the microphone input audio gain.	COMMAND #MIC-GAIN?_<P1, P2><CR> FEEDBACK ~nn@MIC-GAIN_<P1, P2, P3><CR><LF>	P1 = 0 P1 – Mic number 0 = Mic 1 1 = Mic 2 P3 – Level = 0 to 100	Get the mic 2 gain: #MIC-GAIN?_0,1<CR>
MIC-TLK	Set mic talkover parameters.	COMMAND #MIC-TLK_<channel, P1, value><CR> FEEDBACK ~nn@MIC-TLK_<channel, P1, value><CR><LF>	channel = 0 P1 – Parameter setting 0 = Depth 1 = Trigger 2 = Attack time 3 = Hold time 4 = Release time value – P1 value (in corresponding to P1 units) Depth: 0-100% Trigger: 0-100 (-60dB to 40dB) Attack time/Hold time/Release time: 0-200 (0 to 20sec)	Set mic depth to 50: #MIC-TLK_0,0,50<CR>
MIC-TLK?	Get mic talkover parameters.	COMMAND #MIC-TLK?_<channel, P1><CR> FEEDBACK ~nn@MIC-TLK_<channel, P1, value><CR><LF>	channel = 0 P1 – Parameter setting 0 = Depth 1 = Trigger 2 = Attack time 3 = Hold time 4 = Release time value – P1 value (in corresponding to P1 units) Depth: 0-100% Trigger: 0-100 (-60dB to 40dB) Attack time/Hold time/Release time: 0-200 (0 to 20sec)	Get mic trigger value: #MIC-TLK?_0,1<CR>

Function	Description	Syntax	Parameters/Attributes	Example
MODEL?	Get device model. ① This command identifies equipment connected to VP-550X and notifies of identity changes to the connected equipment. The Scaler saves this data in memory to answer REMOTE-INFO requests.	COMMAND #MODEL?_<CR> FEEDBACK ~nn@MODEL_<model_name><CR><LF>	model_name – String of up to 19 printable ASCII chars	Get the device model: #MODEL?_<CR>
MUTE	Set audio mute.	COMMAND #MUTE_<channel>,<mute_mode><CR> FEEDBACK ~nn@MUTE_<channel>,<mute_mode><CR><LF>	channel – 0 = Output 1 – Scaler mute_mode – On/Off 0 = Off 1 = On	Set output to mute: #MUTE_0,1<CR>
MUTE?	Get audio mute.	COMMAND #MUTE?_<channel><CR> FEEDBACK ~nn@MUTE_<channel>,<mute_mode><CR><LF>	channel – 0 = Output 1 – Scaler mute_mode – On/Off 0 = Off 1 = On	Get mute status of output #MUTE_0?<CR>
NAME	Set machine (DNS) name. ① The machine name is not the same as the model name. The machine name is used to identify a specific machine or a network in use (with DNS feature on).	COMMAND #NAME_<machine_name><CR> FEEDBACK ~nn@NAME_<machine_name><CR><LF>	machine_name – String of up to 15 alpha-numeric chars (can include hyphen, not at the beginning or end)	Set the DNS name of the device to room-442: #NAME_<room-442><CR>
NAME?	Get machine (DNS) name. ① The machine name is not the same as the model name. The machine name is used to identify a specific machine or a network in use (with DNS feature on).	COMMAND #NAME?_<CR> FEEDBACK ~nn@NAME_<machine_name><CR><LF>	machine_name – String of up to 15 alpha-numeric chars (can include hyphen, not at the beginning or end)	Get the DNS name of the device: #NAME?_<CR>
NAME-RST	Reset machine (DNS) name to factory default. ① Factory default of machine (DNS) name is "KRAMER_" + 4 last digits of device serial number.	COMMAND #NAME-RST<CR> FEEDBACK ~nn@NAME-RST_OK<CR><LF>		Reset the machine name (S/N last digits are 0102): #NAME-RST_KRAMER_0102<CR>
NET-DHCP	Set DHCP mode.	COMMAND #NET-DHCP_<dhcp_state><CR> FEEDBACK ~nn@NET-DHCP_<dhcp_state><CR><LF>	dhcp_state – 0 = Off 1 = On (Use DHCP if unavailable, use the IP address set by the factory or the net-ip command).	Enable DHCP mode: #NET-DHCP_1<CR>
NET-DHCP?	Get DHCP mode.	COMMAND #NET-DHCP?<CR> FEEDBACK ~nn@NET-DHCP_<dhcp_state> <CR><LF>	dhcp_state – 0 = Off 1 = On (Use DHCP if unavailable, use the IP address set by the factory or the net-ip command).	Get DHCP mode: #NET-DHCP?_<CR>
NET-GATE	Set gateway IP. ① A network gateway connects the device via another network and maybe over the Internet. Be careful of security issues. For proper settings consult your network administrator.	COMMAND #NET-GATE_<ip_address><CR> FEEDBACK ~nn@NET-GATE_<ip_address><CR><LF>	ip_address – Format: xxx.xxx.xxx.xxx	Set the gateway IP address to 192.168.0.1: #NET-GATE_192.168.000.001<CR>>
NET-GATE?	Get gateway IP. ① A network gateway connects the device via another network and maybe over the Internet. Be aware of security problems.	COMMAND #NET-GATE?_<CR> FEEDBACK ~nn@NET-GATE_<ip_address><CR><LF>	ip_address – Format: xxx.xxx.xxx.xxx	Get the gateway IP address: #NET-GATE?_<CR>
NET-IP	Set IP address. ① For proper settings consult your network administrator.	COMMAND #NET-IP_<ip_address><CR> FEEDBACK ~nn@NET-IP_<ip_address><CR><LF>	ip_address – Format: xxx.xxx.xxx.xxx	Set the IP address to 192.168.1.39: #NET-IP_192.168.001.039<CR>
NET-IP?	Get IP address.	COMMAND #NET-IP?_<CR> FEEDBACK ~nn@NET-IP_<ip_address><CR><LF>	ip_address – Format: xxx.xxx.xxx.xxx	Get the IP address: #NET-IP?_<CR>

Function	Description	Syntax	Parameters/Attributes	Example
NET-MAC?	Get MAC address. ① For backward compatibility, the <code>id</code> parameter can be omitted. In this case, the Network ID, by default, is 0, which is the Ethernet control port.	COMMAND #NET-MAC?_id<CR> FEEDBACK ~nn@NET-MAC_id,mac_address<CR><LF>	<code>id</code> – Network ID—the device network interface (if there are more than one). Counting is 0 based, meaning the control port is '0', additional ports are 1,2,3.... <code>mac_address</code> – Unique MAC address. Format: XX-XX-XX-XX-XX-XX where X is hex digit	#NET-MAC?_id<CR>
NET-MASK	Set subnet mask. ① For proper settings consult your network administrator.	COMMAND #NET-MASK_net_mask<CR> FEEDBACK ~nn@NET-MASK_net_mask<CR><LF>	<code>net_mask</code> – Format: xxx.xxx.xxx.xxx	Set the subnet mask to 255.255.0.0: #NET-MASK_255.255.000.000<CR>
NET-MASK?	Get subnet mask.	COMMAND #NET-MASK?_<CR> FEEDBACK ~nn@NET-MASK_net_mask<CR><LF>	<code>net_mask</code> – Format: xxx.xxx.xxx.xxx	Get the subnet mask: #NET-MASK?<CR>
PROT-VER?	Get device protocol version.	COMMAND #PROT-VER?_<CR> FEEDBACK ~nn@PROT-VER_3000:version<CR><LF>	<code>version</code> – XX.XX where X is a decimal digit	Get the device protocol version: #PROT-VER?_<CR>
PSU?	Get PSU status.	COMMAND #PSU?_<CR> FEEDBACK ~nn@PSU_status<CR><LF>	<code>status</code> – 0 = Fail 1 = Pass	Get PSU status: #PSU?_<CR>
RESET	Reset device. ① To avoid locking the port due to a USB bug in Windows, disconnect USB connections immediately after running this command. If the port was locked, disconnect and reconnect the cable to reopen the port.	COMMAND #RESET<CR> FEEDBACK ~nn@RESET_OK<CR><LF>		Reset the device: #RESET<CR>
ROUTE	Set layer routing. ① This command replaces all other routing commands.	COMMAND #ROUTE_layer,dest,src<CR> FEEDBACK ~nn@ROUTE_layer,dest,src<CR><LF>	<code>layer</code> Layer Enumeration 1 = Video+audio <code>dest</code> 1 = Scaler <code>src</code> – Source id 1 = HDMI 1 2 = HDMI 2 3 = HDMI 3 4 = HDMI 4 5 = HDMI 5 6 = HDMI 6 7 = HDMI 7 8 = USB-C 9 = VGA 10 = CV	Route HDMI 2 to the output: #ROUTE_1,1,2<CR>
ROUTE?	Get layer routing. ① This command replaces all other routing commands.	COMMAND #ROUTE?_layer,dest<CR> FEEDBACK ~nn@ROUTE_layer,dest,src<CR><LF>	<code>layer</code> Layer Enumeration 1 = Video+audio <code>dest</code> 1 = Scaler <code>src</code> – Source id 1 = HDMI 1 2 = HDMI 2 3 = HDMI 3 4 = HDMI 4 5 = HDMI 5 6 = HDMI 6 7 = HDMI 7 8 = USB-C 9 = VGA 10 = CV	Get the layer routing: #ROUTE?_layer,dest<CR>
SCLR-AS	Set auto-sync features. ① Sets the auto sync features for the selected scaler.	COMMAND #SCLR-AS_P1,P2<CR> FEEDBACK Set / Get : ~nn@SCLR-AS_P1,P2...<CR><LF>	<code>P1</code> –1 <code>P2</code> – Sync Speed 0 = disable 1 = fast 2 = slow 3 = immediate	Set auto-sync to fast: #SCLR-AS_1,1<CR>
SCLR-AS?	Get auto-sync features. ① Gets the auto sync features for the selected scaler.	COMMAND #SCLR-AS?_P1<CR> FEEDBACK Set / Get : ~nn@SCLR-AS_P1,P2...<CR><LF>	<code>P1</code> –1 <code>P2</code> – Sync Speed	Get auto-sync features: #SCLR-AS?_1<CR>
SCLR-AUDIO-DELAY	Set the scaler audio delay. ① Sets the audio delay for the selected audio output.	COMMAND #SCLR-AUDIO-DELAY_P1,P2<CR> FEEDBACK ~nn@SCLR-AUDIO-DELAY_P1,P2<CR><LF>	<code>P1</code> – Audio output number 1 = Scaler <code>P2</code> – Delay 0 = Off 1 = 40ms 2 = 110ms 3 = 150ms	Set the scaler audio delay to 40ms: #SCLR-AUDIO-DELAY_1,1<CR>
SCLR-AUDIO-DELAY?	Get the scaler audio delay. ① Gets the audio delay for the selected audio output.	COMMAND #SCLR-AUDIO-DELAY?_P1<CR> FEEDBACK ~nn@SCLR-AUDIO-DELAY_P1,P2<CR><LF>	<code>P1</code> – Audio output number 1 = Scaler <code>P2</code> – Delay 0 = Off 1 = 40ms 2 = 110ms 3 = 150ms	Get the scaler audio delay: #SCLR-AUDIO-DELAY?_1<CR>

Function	Description	Syntax	Parameters/Attributes	Example
SCLR-PCAUTO	Set PC auto sync of scaler. ① Trigger the Auto Adjust feature of PC input.	COMMAND #SCLR-PCAUTO_<P1>,<P2><CR> FEEDBACK ~nn@SCLR-PCAUTO_<P1>,<P2>...<CR><LF>	P1 – Scaler Number 1 = Scaler1 P2 –Yes (“Yes” triggers the Auto-scan function. When complete, the unit returns to the “No” state)	Set PC auto sync of scaler: #SCLR-PCAUTO_<u>1,<yes><CR>
SIGNAL?	Get input signal status.	COMMAND #SIGNAL?_<inp_id><CR> FEEDBACK ~nn@SIGNAL_<inp_id>,<status><CR><LF>	inp_id – Input number 1 = HDMI 1 2 = HDMI 2 3 = HDMI 3 4 = HDMI 4 5 = HDMI 5 6 = HDMI 6 7 = HDMI 7 8 = USB-C status – Signal status according to signal validation: 0 = Off 1 = On	Get the input signal status of IN 1: #SIGNAL?_<u>1<CR>
SN?	Get device serial number.	COMMAND #SN?_<CR> FEEDBACK ~nn@SN_<serial_number><CR><LF>	serial_number – 14 decimal digits, factory assigned	Get the device serial number: #SN?_<u><CR>
STANDBY	Set standby mode.	COMMAND #STANDBY_<on_off><CR> FEEDBACK ~nn@STANDBY_<value><CR><LF>	value – On/Off 0 = Off 1 = On	Set standby mode: #STANDBY_<u>1<CR>
STANDBY?	Get standby mode status.	COMMAND #STANDBY?_<CR> FEEDBACK ~nn@STANDBY_<value><CR><LF>	value – On/Off 0 = Off 1 = On	Get standby mode status: #STANDBY?_<u><CR>
TEMPERATURE?	Get temperature status.	COMMAND #TEMPERATURE?_<CR> FEEDBACK ~nn@TEMPERATURE_<status><CR><LF>	status – 0 = Fail 1 = Pass	Get temperature status: #TEMPERATURE?_<u><CR>
TLK	Set audio talkover mode status.	COMMAND #TLK_<channel>,<talkover_mode><CR> FEEDBACK ~nn@TLK_<channel>,<talkover_mode><CR><LF>	channel = 1 (scaler) talkover_mode – 0 = off 1 = mixer 2 = talkover 3 = mic only	Set audio talkover mode status: #TLK_<u>1,<1><CR>
TLK?	Get audio talkover mode status.	COMMAND #TLK?_<channel><CR> FEEDBACK ~nn@TLK_<channel>,<talkover_mode><CR><LF>	channel = 1 (scaler) talkover_mode – 0 = off 1 = mixer 2 = talkover 3 = mic only	Get audio talkover mode status: #TLK?_<u>1<CR>
VERSION?	Get firmware version number.	COMMAND #VERSION?_<CR> FEEDBACK ~nn@VERSION_<firmware_version><CR><LF>	firmware_version – XX.XX.XXXX where the digit groups are: major.minor.build version	Get the device firmware version number: #VERSION?_<u><CR>
VFRZ	Set freeze on selected output.	COMMAND #VFRZ_<out_id>,<freeze_flag><CR> FEEDBACK ~nn@VFRZ_<win_num>,<freeze_flag><CR><LF>	out_id – 1 (scaler) freeze_flag – On/Off 0 = Off 1 = On	Set freeze on selected output: #VFRZ_<u>1,<1><CR>
VFRZ?	Get output freeze status.	COMMAND #VFRZ?_<out_id><CR> FEEDBACK ~nn@VFRZ_<win_num>,<freeze_flag><CR><LF>	out_id – 1 (scaler) freeze_flag – On/Off 0 = Off 1 = On	Get output freeze status: #VFRZ?_<u>1<CR>
VIDEO-BYPASS	Set video bypass status.	COMMAND #VIDEO -BYPASS_<status><CR> FEEDBACK #VIDEO -BYBASS_<status><CR>	status – On/Off 0 = Off 1 = On	Set audio-bypass to off: #VIDEO -BYPASS_<u>0<CR>
VIDEO -BYPASS?	Get video bypass status.	COMMAND #VIDEO -BYPASS?_<CR> FEEDBACK #VIDEO -BYBASS?_<status><CR><LF>	status – On/Off 0 = Off 1 = On	Get audio bypass status: # VIDEO -BYPASS?_<u><CR>

Function	Description	Syntax	Parameters/Attributes	Example
VID-RES	<p>Set output resolution.</p> <p>① "Set" command is only applicable for stage=Output.</p> <p>"Set" command with is_native=ON sets native resolution on selected output (resolution index sent = 0). Device sends as answer actual VIC ID of native resolution.</p> <p>"Get" command with is_native=ON returns native resolution VIC, with is_native=OFF returns current resolution.</p> <p>To use "custom resolutions" (entries 100-105 In View Modes), define them using the DEF-RES command.</p>	<pre> COMMAND #VID-RES_<stage>,<stage_id>,<is_native>,<resolution><CR> FEEDBACK ~nn@VID-RES_<stage>,<stage_id>,<is_native>,<resolution><CR><LF> </pre>	<pre> stage – Output 1 = Output stage_id = 1 (scaler) is_native – Native resolution flag 0 = Off resolution – Resolution index 200= Native HDMI 1 201=640x480 202=800x600 203=1024x768 204=1280x768 205=1360x768 206=1280x720 207=1280x800 208=1280x1024 209=1440x900 210=1400x1050 211=1680x1050 212=1600x1200 213=1920x1080 214=1920x1200 215=2560x1600 216=2560x1440 217=480p 218=576p 219=720p50 220=720p60 221=1080p24 222=1080p25 223=1080p30 224=1080p50 225=1080p60 226=4K24 227=4K25 228=4K30 229=4K50 230=4K60 231=4K50(4:2:0) 232=4K60(4:2:0) 233=Native HDMI 2 </pre>	<p>Set output resolution to 480p: #VID-RES_1,1,0,217<CR></p>
VID-RES?	<p>Set output resolution.</p> <p>① "Get" command is only applicable for stage=Output.</p> <p>"Set" command with is_native=ON sets native resolution on selected output (resolution index sent = 0). Device sends as answer actual VIC ID of native resolution.</p> <p>"Get" command with is_native=ON returns native resolution VIC, with is_native=OFF returns current resolution.</p> <p>To use "custom resolutions" (entries 100-105 In View Modes), define them using the DEF-RES command.</p>	<pre> COMMAND #VID-RES?_<stage>,<stage_id>,<is_native><CR> FEEDBACK ~nn@VID-RES?_<stage>,<stage_id>,<is_native>,<resolution><CR><LF> </pre>	<pre> stage –Output 1 = Output stage_id = 1 (scaler) is_native – Native resolution flag 0 = Off resolution – Resolution index 200= Native HDMI1 201=640x480 202=800x600 203=1024x768 204=1280x768 205=1360x768 206=1280x720 207=1280x800 208=1280x1024 209=1440x900 210=1400x1050 211=1680x1050 212=1600x1200 213=1920x1080 214=1920x1200 215=2560x1600 216=2560x1440 217=480p 218=576p 219=720p50 220=720p60 221=1080p24 222=1080p25 223=1080p30 224=1080p50 225=1080p60 226=4K24 227=4K25 228=4K30 229=4K50 230=4K60 231=4K50(4:2:0) 232=4K60(4:2:0) 233=Native HDMI 2 </pre>	<p>Get output resolution: #VID-RES?_1,1,0<CR></p>
VMUTE	<p>Set enable/disable video on output.</p>	<pre> COMMAND #VMUTE_<output_id>,<flag><CR> FEEDBACK ~nn@VMUTE_<output_id>,<flag><CR><LF> </pre>	<pre> output_id = 1 (scaler) flag – Video Mute 0 – Off (video enabled) 1 – On (video disabled) </pre>	<p>Disable the video output on OUT 1: #VMUTE_1, 0<CR></p>
VMUTE?	<p>Get video on output status.</p>	<pre> COMMAND #VMUTE?_<output_id> <CR> FEEDBACK ~nn@VMUTE_<output_id>,<flag><CR><LF> </pre>	<pre> output_id = 1 (scaler) flag – Video Mute 0 – Off (video enabled) 1 – On (video disabled) </pre>	<p>Get video on output status: #VMUTE?_1<CR></p>

Result and Error Codes

Syntax

In case of an error, the device responds with an error message. The error message syntax:

- **~NN@ERR XXX<CR><LF>** – when general error, no specific command
- **~NN@CMD ERR XXX<CR><LF>** – for specific command
- **NN** – machine number of device, default = 01
- **XXX** – error code

Error Codes

Error Name	Error Code	Description
P3K_NO_ERROR	0	No error
ERR_PROTOCOL_SYNTAX	1	Protocol syntax
ERR_COMMAND_NOT_AVAILABLE	2	Command not available
ERR_PARAMETER_OUT_OF_RANGE	3	Parameter out of range
ERR_UNAUTHORIZED_ACCESS	4	Unauthorized access
ERR_INTERNAL_FW_ERROR	5	Internal FW error
ERR_BUSY	6	Protocol busy
ERR_WRONG_CRC	7	Wrong CRC
ERR_TIMEDOUT	8	Timeout
ERR_RESERVED	9	(Reserved)
ERR_FW_NOT_ENOUGH_SPACE	10	Not enough space for data (firmware, FPGA...)
ERR_FS_NOT_ENOUGH_SPACE	11	Not enough space – file system
ERR_FS_FILE_NOT_EXISTS	12	File does not exist
ERR_FS_FILE_CANT_CREATED	13	File can't be created
ERR_FS_FILE_CANT_OPEN	14	File can't open
ERR_FEATURE_NOT_SUPPORTED	15	Feature is not supported
ERR_RESERVED_2	16	(Reserved)
ERR_RESERVED_3	17	(Reserved)
ERR_RESERVED_4	18	(Reserved)
ERR_RESERVED_5	19	(Reserved)
ERR_RESERVED_6	20	(Reserved)
ERR_PACKET_CRC	21	Packet CRC error
ERR_PACKET_MISSED	22	Packet number isn't expected (missing packet)
ERR_PACKET_SIZE	23	Packet size is wrong
ERR_RESERVED_7	24	(Reserved)
ERR_RESERVED_8	25	(Reserved)
ERR_RESERVED_9	26	(Reserved)
ERR_RESERVED_10	27	(Reserved)
ERR_RESERVED_11	28	(Reserved)
ERR_RESERVED_12	29	(Reserved)
ERR_EDID_CORRUPTED	30	EDID corrupted
ERR_NON_LISTED	31	Device specific errors
ERR_SAME_CRC	32	File has the same CRC – not changed
ERR_WRONG_MODE	33	Wrong operation mode
ERR_NOT_CONFIGURED	34	Device/chip was not initialized

The warranty obligations of Kramer Electronics Inc. ("Kramer Electronics") for this product are limited to the terms set forth below:

What is Covered

This limited warranty covers defects in materials and workmanship in this product.

What is Not Covered

This limited warranty does not cover any damage, deterioration or malfunction resulting from any alteration, modification, improper or unreasonable use or maintenance, misuse, abuse, accident, neglect, exposure to excess moisture, fire, improper packing and shipping (such claims must be presented to the carrier), lightning, power surges, or other acts of nature. This limited warranty does not cover any damage, deterioration or malfunction resulting from the installation or removal of this product from any installation, any unauthorized tampering with this product, any repairs attempted by anyone unauthorized by Kramer Electronics to make such repairs, or any other cause which does not relate directly to a defect in materials and/or workmanship of this product. This limited warranty does not cover cartons, equipment enclosures, cables or accessories used in conjunction with this product.

Without limiting any other exclusion herein, Kramer Electronics does not warrant that the product covered hereby, including, without limitation, the technology and/or integrated circuit(s) included in the product, will not become obsolete or that such items are or will remain compatible with any other product or technology with which the product may be used.

How Long this Coverage Lasts

The standard limited warranty for Kramer products is seven (7) years from the date of original purchase, with the following exceptions:

1. All Kramer VIA hardware products are covered by a standard three (3) year warranty for the VIA hardware and a standard three (3) year warranty for firmware and software updates; all Kramer VIA accessories, adapters, tags, and dongles are covered by a standard one (1) year warranty.
2. Kramer fiber optic cables, adapter-size fiber optic extenders, pluggable optical modules, active cables, cable retractors, ring mounted adapters, portable power chargers, Kramer speakers, and Kramer touch panels are all covered by a standard one (1) year warranty.
3. All Kramer Cobra products, all Kramer Calibre products, all Kramer Minicom digital signage products, all HighSecLabs products, all streaming, and all wireless products are covered by a standard three (3) year warranty.
4. All Sierra Video MultiViewers are covered by a standard five (5) year warranty.
5. Sierra switchers & control panels are covered by a standard seven (7) year warranty (excluding power supplies and fans that are covered for three (3) years).
6. K-Touch software is covered by a standard one (1) year warranty for software updates.
7. All Kramer passive cables are covered by a ten (10) year warranty.

Who is Covered

Only the original purchaser of this product is covered under this limited warranty. This limited warranty is not transferable to subsequent purchasers or owners of this product.

What Kramer Electronics Will Do

Kramer Electronics will, at its sole option, provide one of the following three remedies to whatever extent it shall deem necessary to satisfy a proper claim under this limited warranty:

1. Elect to repair or facilitate the repair of any defective parts within a reasonable period of time, free of any charge for the necessary parts and labor to complete the repair and restore this product to its proper operating condition. Kramer Electronics will also pay the shipping costs necessary to return this product once the repair is complete.
2. Replace this product with a direct replacement or with a similar product deemed by Kramer Electronics to perform substantially the same function as the original product. If a direct or similar replacement product is supplied, the original product's end warranty date remains unchanged and is transferred to the replacement product.
3. Issue a refund of the original purchase price less depreciation to be determined based on the age of the product at the time remedy is sought under this limited warranty.

What Kramer Electronics Will Not Do Under This Limited Warranty

If this product is returned to Kramer Electronics or the authorized dealer from which it was purchased or any other party authorized to repair Kramer Electronics products, this product must be insured during shipment, with the insurance and shipping charges prepaid by you. If this product is returned uninsured, you assume all risks of loss or damage during shipment. Kramer Electronics will not be responsible for any costs related to the removal or re-installation of this product from or into any installation. Kramer Electronics will not be responsible for any costs related to any setting up this product, any adjustment of user controls or any programming required for a specific installation of this product.

How to Obtain a Remedy Under This Limited Warranty

To obtain a remedy under this limited warranty, you must contact either the authorized Kramer Electronics reseller from whom you purchased this product or the Kramer Electronics office nearest you. For a list of authorized Kramer Electronics resellers and/or Kramer Electronics authorized service providers, visit our web site at www.kramerav.com or contact the Kramer Electronics office nearest you.

In order to pursue any remedy under this limited warranty, you must possess an original, dated receipt as proof of purchase from an authorized Kramer Electronics reseller. If this product is returned under this limited warranty, a return authorization number, obtained from Kramer Electronics, will be required (RMA number). You may also be directed to an authorized reseller or a person authorized by Kramer Electronics to repair the product.

If it is decided that this product should be returned directly to Kramer Electronics, this product should be properly packed, preferably in the original carton, for shipping. Cartons not bearing a return authorization number will be refused.

Limitation of Liability

THE MAXIMUM LIABILITY OF KRAMER ELECTRONICS UNDER THIS LIMITED WARRANTY SHALL NOT EXCEED THE ACTUAL PURCHASE PRICE PAID FOR THE PRODUCT. TO THE MAXIMUM EXTENT PERMITTED BY LAW, KRAMER ELECTRONICS IS NOT RESPONSIBLE FOR DIRECT, SPECIAL, INCIDENTAL OR CONSEQUENTIAL DAMAGES RESULTING FROM ANY BREACH OF WARRANTY OR CONDITION, OR UNDER ANY OTHER LEGAL THEORY. Some countries, districts or states do not allow the exclusion or limitation of relief, special, incidental, consequential or indirect damages, or the limitation of liability to specified amounts, so the above limitations or exclusions may not apply to you.

Exclusive Remedy

TO THE MAXIMUM EXTENT PERMITTED BY LAW, THIS LIMITED WARRANTY AND THE REMEDIES SET FORTH ABOVE ARE EXCLUSIVE AND IN LIEU OF ALL OTHER WARRANTIES, REMEDIES AND CONDITIONS, WHETHER ORAL OR WRITTEN, EXPRESS OR IMPLIED. TO THE MAXIMUM EXTENT PERMITTED BY LAW, KRAMER ELECTRONICS SPECIFICALLY DISCLAIMS ANY AND ALL IMPLIED WARRANTIES, INCLUDING, WITHOUT LIMITATION, WARRANTIES OF MERCHANTABILITY AND FITNESS FOR A PARTICULAR PURPOSE. IF KRAMER ELECTRONICS CANNOT LAWFULLY DISCLAIM OR EXCLUDE IMPLIED WARRANTIES UNDER APPLICABLE LAW, THEN ALL IMPLIED WARRANTIES COVERING THIS PRODUCT, INCLUDING WARRANTIES OF MERCHANTABILITY AND FITNESS FOR A PARTICULAR PURPOSE, SHALL APPLY TO THIS PRODUCT AS PROVIDED UNDER APPLICABLE LAW.

IF ANY PRODUCT TO WHICH THIS LIMITED WARRANTY APPLIES IS A "CONSUMER PRODUCT" UNDER THE MAGNUSON-MOSS WARRANTY ACT (15 U.S.C.A. §2301, ET SEQ.) OR OTHER APPLICABLE LAW, THE FOREGOING DISCLAIMER OF IMPLIED WARRANTIES SHALL NOT APPLY TO YOU, AND ALL IMPLIED WARRANTIES ON THIS PRODUCT, INCLUDING WARRANTIES OF MERCHANTABILITY AND FITNESS FOR THE PARTICULAR PURPOSE, SHALL APPLY AS PROVIDED UNDER APPLICABLE LAW.

Other Conditions

This limited warranty gives you specific legal rights, and you may have other rights which vary from country to country or state to state.

This limited warranty is void if (i) the label bearing the serial number of this product has been removed or defaced, (ii) the product is not distributed by Kramer Electronics or (iii) this product is not purchased from an authorized Kramer Electronics reseller. If you are unsure whether a reseller is an authorized Kramer Electronics reseller, visit our web site at www.kramerav.com or contact a Kramer Electronics office from the list at the end of this document.

Your rights under this limited warranty are not diminished if you do not complete and return the product registration form or complete and submit the online product registration form. Kramer Electronics thanks you for purchasing a Kramer Electronics product. We hope it will give you years of satisfaction.



P/N: 2900-301296



Rev: 1



SAFETY WARNING

Disconnect the unit from the power supply before opening and servicing

For the latest information on our products and a list of Kramer distributors, visit our Web site where updates to this user manual may be found.

We welcome your questions, comments, and feedback.

The terms HDMI, HDMI High-Definition Multimedia Interface, and the HDMI Logo are trademarks or registered trademarks of HDMI Licensing Administrator, Inc. All brand names, product names, and trademarks are the property of their respective owners.