



# Instruction Manual

Thank you for purchasing this product.  
Before using this product please read the instructions carefully.  
After reading the instruction manual, please keep it for reference.

## Caution



### Caution

### Parents/Guardians: Please read the following information carefully.

- Keep this product away from small children or infants. Seek medical attention immediately if any small parts are swallowed.
- Long cord. Strangulation hazard.
- Do not use high volume settings for an extended period of time to avoid hearing loss.
- Keep the product away from dusty or humid areas.
- Do not use this product if it has been damaged or modified.
- Do not get this product wet. This may cause an electric shock or malfunction.
- Do not touch the metal parts of the USB plug.
- Do not use the USB plug when it's covered with dust.
- Do not place this product near heat sources or leave under direct sunlight for an extended period. Overheating may cause malfunction.
- Do not twist or bundle the cables.
- Do not get this product wet. This may cause an electric shock or malfunction.
- Do not apply strong impact or weight on the product.
- Do not pull roughly or bend the cable of the product.
- Do not disassemble, modify or attempt to repair this product.
- If product needs cleaning, use only a soft dry cloth. Do not use any chemical agents like benzene or thinner.
- Do not use this product for anything other than its intended purpose. We are not responsible for any accidents or damages in the event of use other than the intended purpose.



Turn down the volume before connecting to the Xbox Series X|S controller. Connecting at a high volume setting may cause a loud sound, which may damage your ears.

## Battery Precautions

If batteries leak, please do not touch the acid with your bare hands.  
Do not place this product near heat sources or leave under direct sunlight.  
Internal battery life may deplete over time.

- Please be aware of the following during usage or storage. The built-in battery may overheat or rupture, and may cause fire, electric shock, injury, deformation or malfunction of the product.
  - Do not place the product in fire, microwave, high-pressure containers, or use a dryer to dry.
  - Keep this product away from the following high temperature areas:
    - Near heat sources or leave under direct sunlight
    - Heated carpet, high pile carpet, or on top of home theater equipment
    - Outdoors or inside a car during the summer
- Do not charge this product other than by its specified method. The built-in battery may overheat or rupture, and it may cause fire or malfunction of the product.
- Do not touch if this product is charging when lightning strikes, as there may be risk of electric shock.
- Keep USB connector away from metal objects. This may cause overheating, rupturing, electric shock, or leakage.

- Never disassemble, repair or modify this product. It may cause of fire, rupturing or overheating.
- Do not drop, step on, or inflict strong impact. This may cause ignition, overheating, or rupture.
- Keep the product away from liquid or foreign matter. It may cause fire, electric shock, or malfunction. If any liquid or foreign matter gets inside the product, stop using the product immediately and contact us for inspection.
- Keep the product away from water and do not use with wet or oily hands. It may cause electric shock or malfunction.
- Keep the product away from humid, dusty, or smoky areas. It may cause electric shock or malfunction.
- Keep the USB connector away from foreign matter or dust. It may cause electric shock, malfunction, or contact failure. Use a dry cloth to wipe off any foreign matter or dust.
- Charge this product where the room temperature is 10 - 35°C (50 - 95°F). Charging outside this temperature range may result in the product not charging properly or prolong the charging time.
- The charge and discharge life of the internal battery of this product is about 500 times. Battery life depends on storage method, usage, environment, etc.
- If the battery life drastically diminishes or device stops functioning on a full charge, the battery life has come to its end.
- Recharge the battery at least once in three months to maintain function even if it has not been used for a prolonged time.



The Lithium Polymer battery is made from recyclable resources.

Li-ion 00

## Included

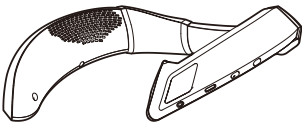

Neckset ×1



Audio Cable ×1



Charging Cable ×1

## Platform

### Xbox Series X|S / Xbox One / Windows 10

#### Important

Before using this product with the Xbox Series X|S / Xbox One system, please read the included instructions carefully.

Please check that your Xbox Series X|S / Xbox One is updated to the latest system firmware.

This product is designed for the Xbox Series X|S, but it can also be used with the Xbox One and Windows 10 by following the instructions in this manual.

# Layout

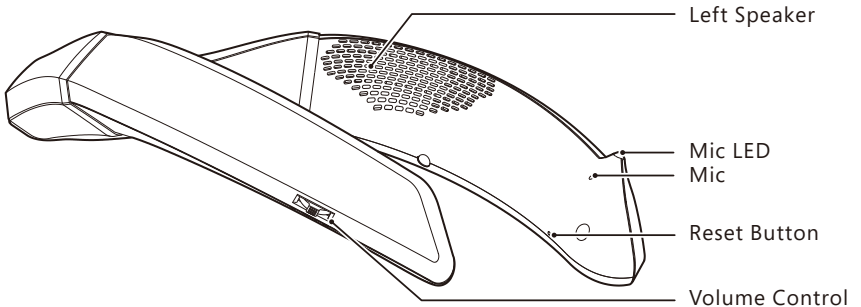
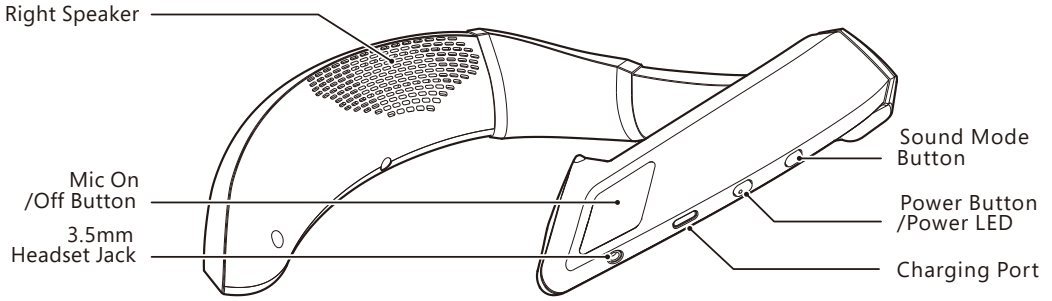

# How to Connect

① Please charge the Neckset.

- \* Please charge the Neckset when before using it for the first time.
- \* Do not press on any buttons when connecting the USB cable.
- \* Check the connector direction before inserting.

Connect to the USB port of the Xbox Series X|S console.

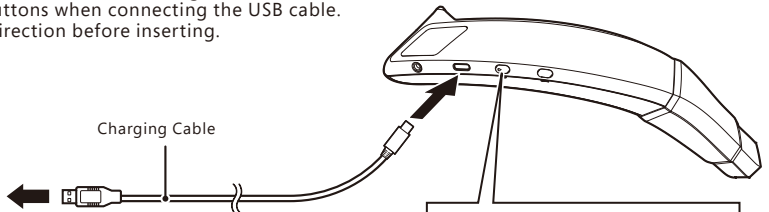

The Power LED light according to the charging status.

Power LED	Red: Charging
	Green: Fully Charged
Power Button	

## Checking the Battery Level

The Mic LED will blink orange and 'beep' four times when the battery level reaches 20% and 10%

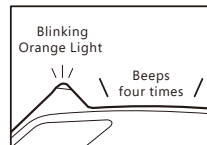

② Connect the audio cable to the Xbox Series X|S controller's 3.5mm Headset Jack

\* Please ensure that the cable is pushed in completely.

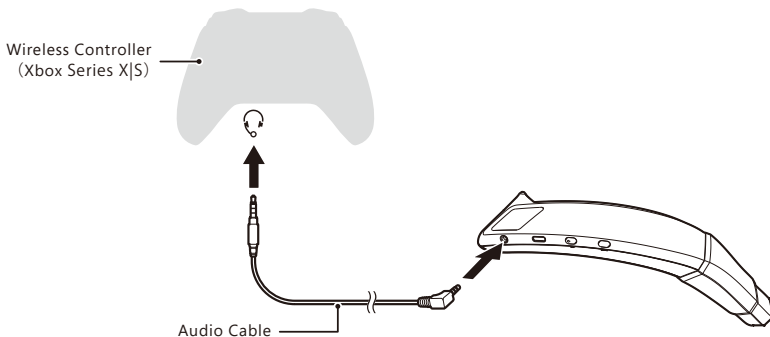

③ Turn on the Neckset.

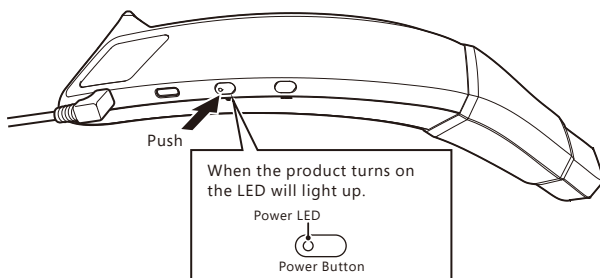

**Turn off the Neckset**

Push and hold the Power Button down for three seconds to turn off.

\* Please turn off when not in use.

\* If the product has not been in use for 30 minutes, the Neckset will 'beep' and then turn off automatically.

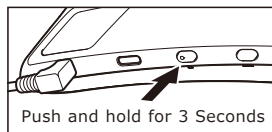

④ Please place the Neckset on your shoulders.

\* Please refer to the image to properly wear the Neckset.

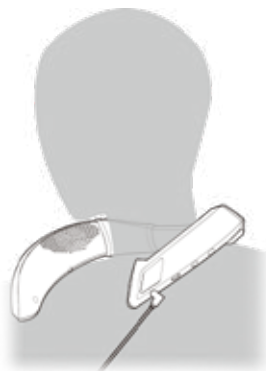

# How to use the Neckset

## Volume Controls

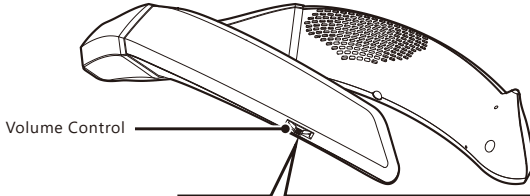

Increase Volume ↔ Decrease Volume

There will be a 'beep' when the minimum or maximum volume has been reached.

## Mic On/Off

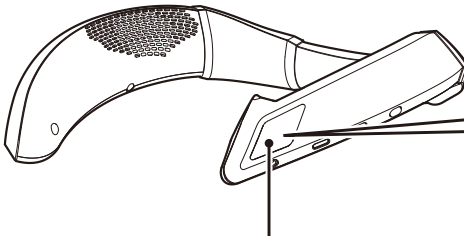

Press the Mic Button to turn the Mic ON and OFF.

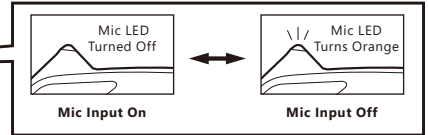

## ! Troubleshoot If an issue occurs, please check the following.

- If there is no sound from the Neckset:
  - Make sure that all plugs are connected all the way in.
  - Ensure that the product is turned ON.
  - Please check that the battery is charged.
  - Check that the volume is turned up.
- If others cannot hear your voice and/or cannot use voice chat:
  - Make sure that all plugs are connected all the way in.
  - Ensure that the product is turned ON.
  - Please check that the battery is charged.
  - Ensure that the Mic Input is turned on.
- Make sure to adjust any other hardware device setting and/or in-game settings.

## Switch between Sound Modes

The Sound Modes can be switched with the Sound Mode Button.

Push the Sound Mode Button once to change the mode.  
There will be one or two 'beep's when switching between modes.

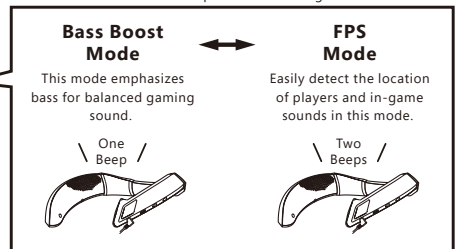
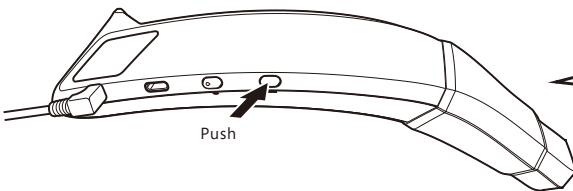

## If the Neckset is not responding

If the product does not respond when the Power Button is pressed, the battery may need to be charged.

Please charge the neckset according to the previous instructions.

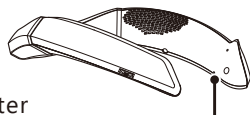

If charging is not possible, if the product does not respond even after charging, or if it responds on its own, press the Reset Button located inside the neckset with a fine-tipped object to reset and reconnect it.

If the neckset still does not respond, please contact our customer support.

When pushing the Reset Button, please use the end of a paper clip and not a sharp needle.



## Main Features

### Neckset

External Dimensions : 250×205×33mm

Weight : 235 g

Maximum Output : 3W + 3W

Driver Aperture : φ30mm ×2

Internal Battery : Lithium Polymer battery

Battery Life : 10 hours

Charging Time : 3 hours

Power Supply : DC5V / 500mA (max)

### Audio Cable

Cable Length : 1.2m

### Charging Cable

Cable Length : 1.0m

## THE FCC WANTS YOU TO KNOW

This device complies with part 15 of the FCC Rules. Operation is subject to the following two conditions: (1) This device may not cause harmful interference, and (2) this device must accept any interference received, including interference that may cause undesired operation.

NOTE: This equipment has been tested and found to comply with the limits for a Class B digital device, pursuant to part 15 of the FCC Rules. These limits are designed to provide reasonable protection against harmful interference in a residential installation. This equipment generates, uses and can radiate radio frequency energy and, if not installed and used in accordance with the instructions, may cause harmful interference to radio communications. However, there is no guarantee that interference will not occur in a particular installation. If this equipment does cause harmful interference to radio or television reception, which can be determined by turning the equipment off and on, the user is encouraged to try to correct the interference by one or more of the following measures:

- Reorient or relocate the receiving antenna.
- Increase the separation between the equipment and receiver.
- Connect the equipment into an outlet on a circuit different from that to which the receiver is connected.
- Consult the dealer or an experienced radio/TV technician for help.

The normal function of the product may be disturbed by strong electro-magnetic interference. If so, simply reset the product to resume normal operation by following the instruction manual (How to connect). In case the function does not resume, please relocate to an area which does not have electro-magnetic interference to use the product.

The wires are not to be inserted into socket-outlets.

The packaging must be retained since it contains important information.

## PRODUCT DISPOSAL INFORMATION

Where you see this symbol on any of our electrical products or packaging, it indicates that the relevant electrical product or battery should not be disposed of as general household waste in Europe. To ensure the correct waste treatment of the product and battery, please dispose of them in accordance with any applicable local laws or requirements for disposal of electrical equipment or batteries. In so doing, you will help to conserve natural resources and improve standards of environmental protection in treatment and disposal of electrical waste. Applicable to EU countries and Turkey only.



EU and Turkey only

US

### Warranty

HORI warrants to the original purchaser that the product purchased new in its original packaging shall be free of any defects in material and workmanship for a period of 90 days from the original date of purchase. If the warranty claim cannot be processed through the original retailer please contact HORI customer support directly at [info@horiusa.com](mailto:info@horiusa.com). Please visit <http://stores.horiusa.com/policies/> for warranty details.

EU

### Warranty

For all warranty claims made within the first 30 days after purchase, please check with the retailer where the original purchase was made for details. If the warranty claim cannot be processed through the original retailer or for any other inquiries pertaining to our products, please contact HORI customer support directly at [info@horiuk.com](mailto:info@horiuk.com).

- The image on the package may differ from the actual product.
- The manufacturer reserves the right to change the product design or specifications without notice.
- Microsoft, Xbox, Xbox "Sphere" Design, Xbox Series X|S, Xbox One, Windows are trademarks of the Microsoft group of companies. All other trademarks are the property of their respective owners.
- HORI & HORI logo are registered trademarks of HORI.



MADE IN CHINA

Ages 6+