

COPYRIGHT © Hangzhou EZVIZ Software Co., Ltd.. ALL RIGHTS RESERVED.

Any and all information, including, among others, wordings, pictures, graphs are the properties of Hangzhou EZVIZ Software Co., Ltd. (hereinafter referred to as "EZVIZ"). This user manual (hereinafter referred to as "the Manual") cannot be reproduced, changed, translated, or distributed, partially or wholly, by any means, without the prior written permission of EZVIZ. Unless otherwise stipulated, EZVIZ does not make any warranties, guarantees or representations, express or implied, regarding to the Manual.

About this Manual

The Manual includes instructions for using and managing the product. Pictures, charts, images and all other information hereinafter are for description and explanation only. The information contained in the Manual is subject to change, without notice, due to firmware updates or other reasons. Please find the latest version in the EZVIZ™ website (<http://www.ezvizlife.com>).

Revision Record

New release – January, 2019

Trademarks Acknowledgement

EZVIZ™, ™, and other EZVIZ's trademarks and logos are the properties of EZVIZ in various jurisdictions. Other trademarks and logos mentioned below are the properties of their respective owners.

Legal Disclaimer

TO THE MAXIMUM EXTENT PERMITTED BY APPLICABLE LAW, THE PRODUCT DESCRIBED, WITH ITS HARDWARE, SOFTWARE AND FIRMWARE, IS PROVIDED "AS IS", WITH ALL FAULTS AND ERRORS, AND EZVIZ MAKES NO WARRANTIES, EXPRESS OR IMPLIED, INCLUDING WITHOUT LIMITATION, MERCHANTABILITY, SATISFACTORY QUALITY, FITNESS FOR A PARTICULAR PURPOSE, AND NON-INFRINGEMENT OF THIRD PARTY. IN NO EVENT WILL EZVIZ, ITS DIRECTORS, OFFICERS, EMPLOYEES, OR AGENTS BE LIABLE TO YOU FOR ANY SPECIAL, CONSEQUENTIAL, INCIDENTAL, OR INDIRECT DAMAGES, INCLUDING, AMONG OTHERS, DAMAGES FOR LOSS OF BUSINESS PROFITS, BUSINESS INTERRUPTION, OR LOSS OF DATA OR DOCUMENTATION, IN CONNECTION WITH THE USE OF THIS PRODUCT, EVEN IF EZVIZ HAS BEEN ADVISED OF THE POSSIBILITY OF SUCH DAMAGES.

TO THE MAXIMUM EXTENT PERMITTED BY APPLICABLE LAW, IN NO EVENT SHALL EZVIZ'S TOTAL LIABILITY FOR ALL DAMAGES EXCEED THE ORIGINAL PURCHASE PRICE OF THE PRODUCT.

EZVIZ DOES NOT UNDERTAKE ANY LIABILITY FOR PERSONAL INJURY OR PROPERTY DAMAGE AS THE RESULT OF PRODUCT INTERRUPTION OR SERVICE TERMINATION CAUSED BY: A) IMPROPER INSTALLATION OR USAGE OTHER THAN AS REQUESTED; B) THE PROTECTION OF NATIONAL OR PUBLIC INTERESTS; C) FORCE MAJEURE; D) YOURSELF OR THE THIRD PARTY, INCLUDING WITHOUT LIMITATION, USING ANY THIRD PARTY'S PRODUCTS, SOFTWARE, APPLICATIONS, AND AMONG OTHERS.

REGARDING TO THE PRODUCT WITH INTERNET ACCESS, THE USE OF PRODUCT SHALL BE WHOLLY AT YOUR OWN RISKS. EZVIZ SHALL NOT TAKE ANY RESPONSIBILITIES FOR ABNORMAL OPERATION, PRIVACY LEAKAGE OR OTHER DAMAGES RESULTING FROM CYBER ATTACK, HACKER ATTACK, VIRUS INSPECTION, OR OTHER INTERNET SECURITY RISKS; HOWEVER, EZVIZ WILL PROVIDE TIMELY TECHNICAL SUPPORT IF REQUIRED. SURVEILLANCE LAWS AND DATA PROTECTION LAWS VARY BY JURISDICTION. PLEASE CHECK ALL RELEVANT LAWS IN YOUR JURISDICTION BEFORE USING THIS PRODUCT IN ORDER TO ENSURE THAT YOUR USE CONFORMS TO THE APPLICABLE LAW. EZVIZ SHALL NOT BE LIABLE IN THE EVENT THAT THIS PRODUCT IS USED WITH ILLEGITIMATE PURPOSES.

IN THE EVENT OF ANY CONFLICTS BETWEEN THE ABOVE AND THE APPLICABLE LAW, THE LATTER PREVAILS.

Package Contents

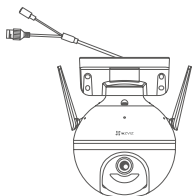

Camera (x1)



Power Adapter (x1)



Screw Kit (x1)

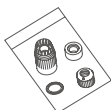

Waterproof Kit (x1)



Drill Template (x1)



Regulatory Information (x1)



Quick Start Guide (x1)

Basics

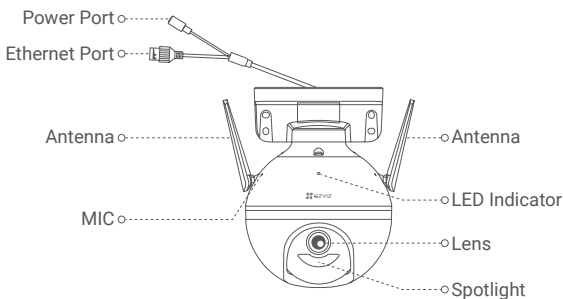

Name

LED Indicator

Description

- Solid Red: Camera starting up.
- Slow-flashing Red: Wi-Fi connection failed.
- Fast-flashing Red: Camera exception (e.g. Micro SD card error).
- Solid Blue: Video being live viewed in the EZVIZ app.
- Slow-flashing Blue: Camera running properly.
- Fast-flashing Blue: Camera ready for Wi-Fi connection.

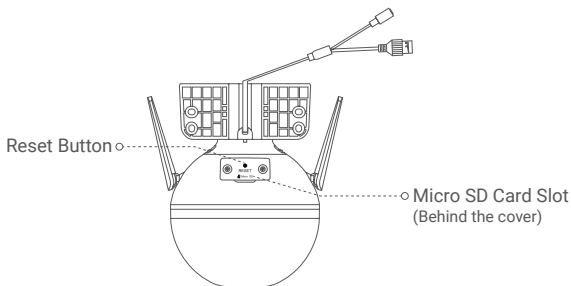

Name

Reset Button

Description

Hold for 5 seconds to restart and reset all parameters to default.

Setup

1. Power-on

Plug the power cable into the camera, and then plug the power adapter into an outlet as shown in the figure below.

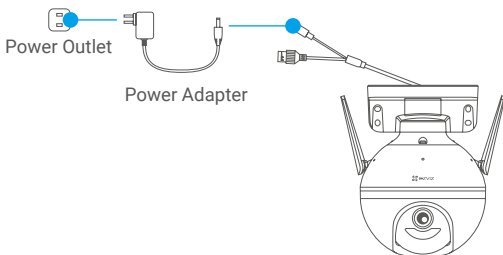

-  The LED indicator turning fast-flashing blue indicates that the camera is powered on and ready for Wi-Fi configuration.

2. Connect to the Internet

1. Get the EZVIZ app

- Connect your mobile phone to Wi-Fi.
- Download and install the EZVIZ app by searching "EZVIZ" in the App Store or Google Play Store™.
- Launch the app and register an EZVIZ user account.

2. Add camera to EZVIZ

Option 1: Wireless Connection

- Log in to your account using the EZVIZ app.
- On the Home screen, tap "+" on the upper-right corner to go to the Scan QR Code interface.

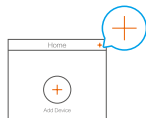

- Scan the QR code on the Quick Start Guide cover or on the body of the camera.

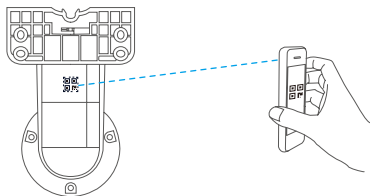

- Follow the EZVIZ app wizard to finish Wi-Fi configuration.

Option 2: Wired Connection

- Connect the camera to the LAN port of your router with the Ethernet cable (not included in the package).

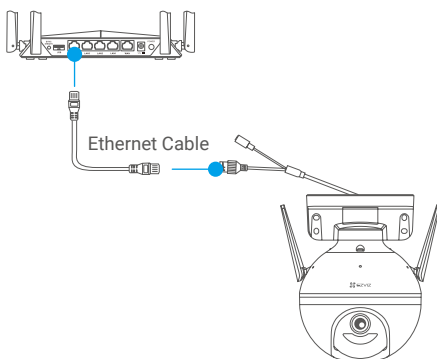

- Log in to your account using the EZVIZ app.
- On the Home screen, tap "+" on the upper-right corner to go to the Scan QR Code interface.

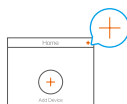

- Scan the QR code on the Quick Start Guide cover or on the body of the camera.

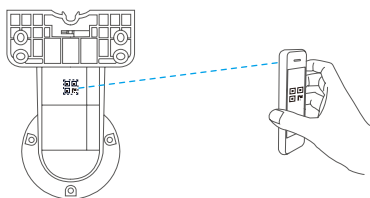

- Follow the wizard to add the camera to the EZVIZ app.

Installation

1. Install the Micro SD Card (Optional)

- Rotate the camera counterclockwise.
- Remove the cover on the camera.
- Insert the micro SD card (sold separately) into the card slot as shown in the figure below.
- Place the cover back on.

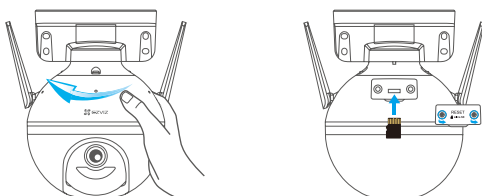

- In the EZVIZ app, tap the **Storage Status** in the Device Settings interface to check the SD card status.
- If the memory card status displays as **Uninitialized**, tap to initialize it. The status will then change to **Normal** and it can store videos.

2. Install the Camera

- Make sure the wall is strong enough to withstand three times the weight of the camera.
- The camera can be mounted on the wall, ceiling or pole.

Wall/Ceiling Mounting

- Place drill template onto the surface you have chosen to mount the camera.
- (For cement wall/ceiling only) Drill screw holes according to the template, and insert four anchors.
- Use four metal screws to fix the camera base.

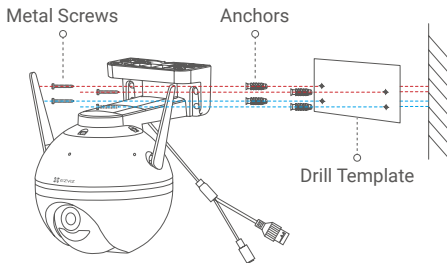

Fig.1 Wall Mounting

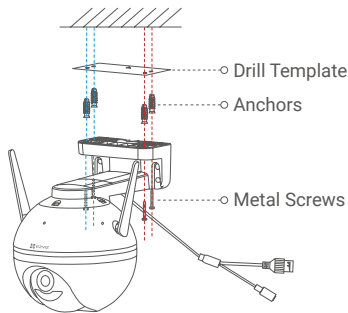
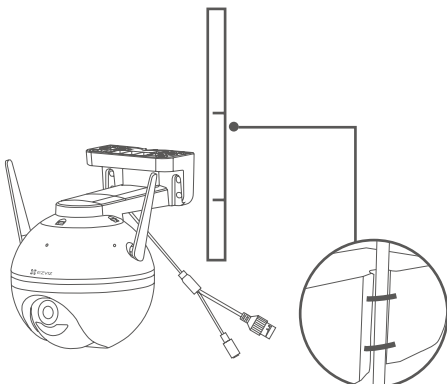

Fig.2 Ceiling Mounting

Pole Mounting

Use the cable tie (not included in the package) to fix the camera base to the pole.



3. Install the Waterproof Kit (Optional)

i If the camera is installed outdoors or in the humid environment, please use the waterproof kit.

- Insert the gasket into the Ethernet port of the camera.



- Pass the A side of the Ethernet cable through the nut, the gasket and the endcap.

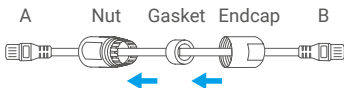

- Tighten up the nut and the endcap.



- Insert the A side into the Ethernet port of the camera and tighten up the nut.



- Connect the B side with the LAN port of the router or PoE switch.



i For detailed information, please refer to www.ezviz.eu.