

datavideo

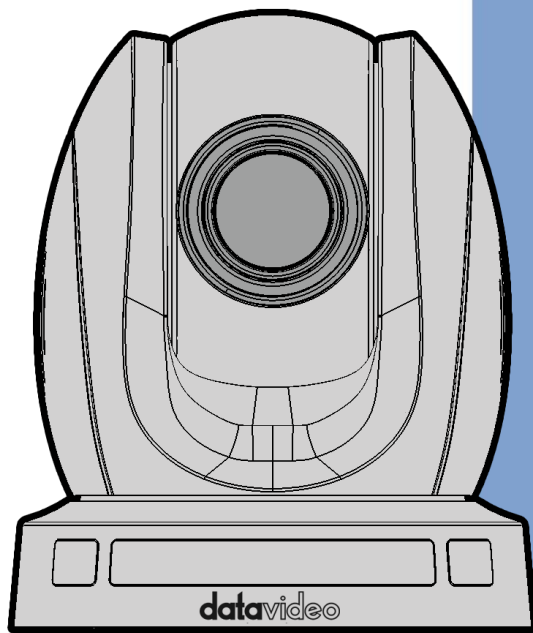

HD PTZ CAMERA

PTC-140

Instruction Manual

www.datavideo.com

Table of Contents

TABLE OF CONTENTS	2
FCC COMPLIANCE STATEMENT	5
WARNINGS AND PRECAUTIONS	5
WARRANTY	6
<i>STANDARD WARRANTY</i>	6
<i>THREE YEAR WARRANTY</i>	7
DISPOSAL	7
1. PRODUCT OVERVIEW	9
<i>FEATURES</i>	9
2. LOCATION AND FUNCTION OF PARTS	10
3. BASIC SETUP	14
3.1 POWER-ON INITIALIZATION.....	14
3.2 VIDEO OUTPUT.....	14
<i>Ethernet Port</i>	14
<i>HDMI Video Output</i>	15
<i>3G-SDI Video Output</i>	15
4. REMOTE CONTROL AND ON-SCREEN MENU	16
4.1 REMOTE CONTROL FUNCTIONS.....	16
4.2 ON-SCREEN MENU	21
5. HOW TO USE THE TALLY LIGHT OPTION IN THE OSD MENU	29
6. INSTALLATION INSTRUCTIONS	38
7. NETWORK CONNECTION	42
7.1 DHCP MODE.....	44
7.2 STATIC IP	46
7.3 DVIP.....	46
8. WEB USER INTERFACE	50
8.1 PREVIEW	50

<i>Control Functions</i>	51
<i>Preset</i>	52
8.2 CONFIGURATION	53
<i>Audio Configure</i>	53
<i>Video Configure</i>	55
<i>Video Encode</i>	55
<i>Stream Publish</i>	58
Stream to Youtube	60
Stream to Facebook	61
Stream via RTSP to Wowza Streaming Cloud	64
SRT Streaming using the vMix Software.....	72
<i>RTP Multicast</i>	86
<i>Video Parameters</i>	87
Focus	87
Exposure.....	88
Color.....	90
Image.....	91
NR.....	93
Style.....	94
<i>Video OSD</i>	95
Enable Video Time and Title on Screen	96
Set Font Color of Time and Title	96
Adjust Time and Title Positions	97
<i>OSD Font Size</i>	97
<i>Video OUT</i>	97
<i>Network Configure</i>	98
<i>Network Port</i>	98
<i>Ethernet</i>	99
<i>DNS</i>	100
<i>SRT</i>	101
<i>System Configure</i>	101
<i>System Attribute</i>	101
<i>System Time</i>	102
<i>System User</i>	103
<i>Update</i>	104
<i>Default</i>	104
<i>Reboot</i>	105
9. REMOTE CONTROL PORT PINOUTS	106
10. FIRMWARE UPDATE	108

REQUIREMENTS	108
PROCEDURE	108
11. FREQUENTLY-ASKED QUESTIONS.....	109
12. DIMENSIONS.....	111
13. SPECIFICATIONS.....	112
SERVICE & SUPPORT.....	116

Disclaimer of Product and Services

The information offered in this instruction manual is intended as a guide only. At all times, Datavideo Technologies will try to give correct, complete and suitable information. However, Datavideo Technologies cannot exclude that some information in this manual, from time to time, may not be correct or may be incomplete. This manual may contain typing errors, omissions or incorrect information. Datavideo Technologies always recommend that you double check the information in this document for accuracy before making any purchase decision or using the product. Datavideo Technologies is not responsible for any omissions or errors, or for any subsequent loss or damage caused by using the information contained within this manual. Further advice on the content of this manual or on the product can be obtained by contacting your local Datavideo Office or dealer.

FCC Compliance Statement

This device complies with part 15 of the FCC rules. Operation is subject to the following two conditions:

- (1) This device may not cause harmful interference, and
- (2) This device must accept any interference received, including interference that may cause undesired operation.

Warnings and Precautions

1. Read all of these warnings and save them for later reference.
2. Follow all warnings and instructions marked on this unit.
3. Unplug this unit from the wall outlet before cleaning. Do not use liquid or aerosol cleaners. Use a damp cloth for cleaning.
4. Do not use this unit in or near water.
5. Do not place this unit on an unstable cart, stand, or table. The unit may fall, causing serious damage.
6. Slots and openings on the cabinet top, back, and bottom are provided for ventilation. To ensure safe and reliable operation of this unit, and to protect it from overheating, do not block or cover these openings. Do not place this unit on a bed, sofa, rug, or similar surface, as the ventilation openings on the bottom of the cabinet will be blocked. This unit should never be placed near or over a heat register or radiator. This unit should not be placed in a built-in installation unless proper ventilation is provided.
7. This product should only be operated from the type of power source indicated on the marking label of the AC adapter. If you are not sure of the type of power available, consult your Datavideo dealer or your local power company.
8. Do not allow anything to rest on the power cord. Do not locate this unit where the power cord will be walked on, rolled over, or otherwise stressed.
9. If an extension cord must be used with this unit, make sure that the total of the ampere ratings on the products plugged into the extension cord do not exceed the extension cord's rating.

10. Make sure that the total amperes of all the units that are plugged into a single wall outlet do not exceed 15 amperes.
11. Never push objects of any kind into this unit through the cabinet ventilation slots, as they may touch dangerous voltage points or short out parts that could result in risk of fire or electric shock. Never spill liquid of any kind onto or into this unit.
12. Except as specifically explained elsewhere in this manual, do not attempt to service this product yourself. Opening or removing covers that are marked “Do Not Remove” may expose you to dangerous voltage points or other risks, and will void your warranty. Refer all service issues to qualified service personnel.
13. Unplug this product from the wall outlet and refer to qualified service personnel under the following conditions:
 - a. When the power cord is damaged or frayed;
 - b. When liquid has spilled into the unit;
 - c. When the product has been exposed to rain or water;
 - d. When the product does not operate normally under normal operating conditions. Adjust only those controls that are covered by the operating instructions in this manual; improper adjustment of other controls may result in damage to the unit and may often require extensive work by a qualified technician to restore the unit to normal operation;
 - e. When the product has been dropped or the cabinet has been damaged;
 - f. When the product exhibits a distinct change in performance, indicating a need for service.

Warranty

Standard Warranty

- Datavideo equipment are guaranteed against any manufacturing defects for one year from the date of purchase.
- The original purchase invoice or other documentary evidence should be supplied at the time of any request for repair under warranty.
- The product warranty period begins on the purchase date. If the purchase date is unknown, the product warranty period begins on the thirtieth day after shipment from a Datavideo office.

- All non-Datavideo manufactured products (product without Datavideo logo) have only one year warranty from the date of purchase.
- Damage caused by accident, misuse, unauthorized repairs, sand, grit or water is not covered under warranty.
- Viruses and malware infections on the computer systems are not covered under warranty.
- Any errors that are caused by unauthorized third-party software installations, which are not required by our computer systems, are not covered under warranty.
- All mail or transportation costs including insurance are at the expense of the owner.
- All other claims of any nature are not covered.
- All accessories including headphones, cables, and batteries are not covered under warranty.
- Warranty only valid in the country or region of purchase.
- Your statutory rights are not affected.

Three Year Warranty

- All Datavideo products purchased after July 1st, 2017 are qualified for a free two years extension to the standard warranty, providing the product is registered with Datavideo within 30 days of purchase.
- Certain parts with limited lifetime expectancy such as LCD panels, DVD drives, Hard Drive, Solid State Drive, SD Card, USB Thumb Drive, Lighting, Camera module, PCIe Card are covered for 1 year.
- The three-year warranty must be registered on Datavideo's official website or with your local Datavideo office or one of its authorized distributors within 30 days of purchase.



Disposal



For EU Customers only - WEEE Marking

This symbol on the product or on its packaging indicates that this product must not be disposed of with your other household waste. Instead, it is your responsibility to dispose of your waste equipment by handing it over to a designated collection point for

the recycling of waste electrical and electronic equipment. The separate collection and recycling of your waste equipment at the time of disposal will help to conserve natural resources and ensure that it is recycled in a manner that protects human health and the environment. For more information about where you can drop off your waste equipment for recycling, please contact your local city office, your household waste disposal service or the shop where you purchased the product.



CE Marking is the symbol as shown on the left of this page. The letters "CE" are the abbreviation of French phrase "Conformité Européene" which literally means "European Conformity". The term initially used was "EC Mark" and it was officially replaced by "CE Marking" in the Directive 93/68/EEC in 1993. "CE Marking" is now used in all EU official documents.

1. Product Overview

The PTC-140 is a low-cost SDI/HDMI PTZ camera featuring 20x optical zoom and 10x digital zoom.

The PTC-140 is also supporting H.264 /H.265 video compression and dual stream outputs.

Features

- 1/2.8 inch CMOS sensor. Resolution is up to 1920x1080 with frame rate up to 60fps.
- Low Noise CMOS effectively ensures high SNR of camera video. Advanced 2D/3D noise reduction technology is also used to further reduce the noise, while ensuring image sharpness.
- Audio Input Interface
- Supports AAC, MP3 and G.711A audio coding with sampling frequencies of 16000, 32000, 44100 and 48000.
- Supports H.264/H.265 video compressions of resolution up to 1920x1080 with frame rate up to 60fps as well as AAC, MP3 and G.711A audio compressions.
- Supports multiple network protocols such as RTSP and RTMP allowing you to easily link to any streaming media servers.

2. Location and Function of Parts

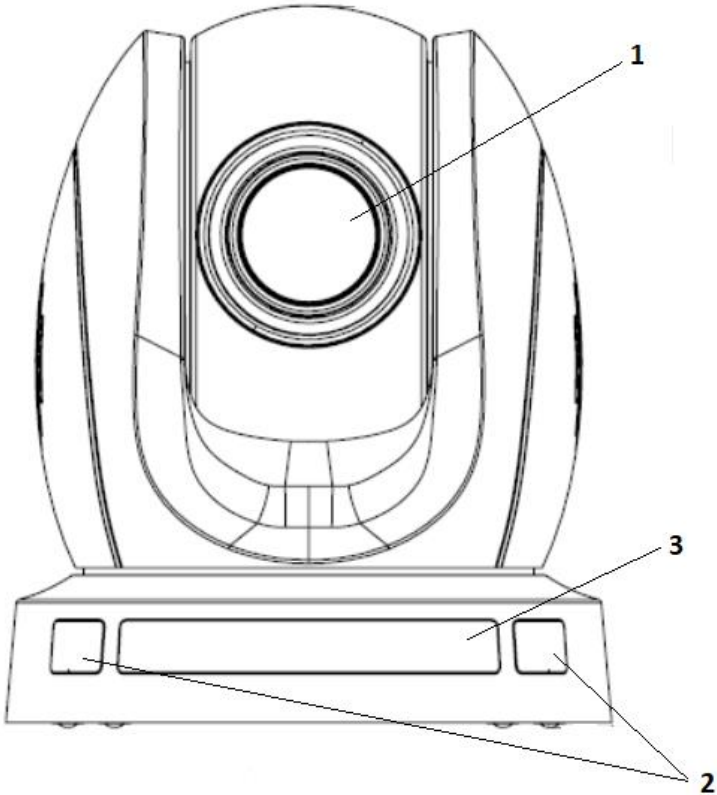
Front of Camera	
	
1	Lens Built-in 1/2.8" 2.07M Pixel CMOS HD color camera with white balance control, backlight compensation, automatic gain and etc.
2	Tally LED Tally lamp will be turned ON upon receiving the ON signal.
3	Sensor for Remote Control Remote control IR receiver

Rear of Camera



1 **Power Input**
DC in socket connects the supplied 12V PSU. The connection can be secured by screwing the outer fastening ring of the DC In plug to the socket.

2 **LAN Port**
This bidirectional port allows you to establish network connection with the camera. Connect an Ethernet cable from this port to the LAN port of a PC in order to monitor the camera video from the web user interface. The LAN port also allows you to stream the camera video using various streaming protocols.

3	<p>HDMI OUT</p> <p>The HDMI OUT allows you to connect an external HDMI monitor via an HDMI cable.</p>
4	<p>3G-SDI OUT</p> <p>The 3G-SDI OUT allows you to connect an external monitor via an SDI cable.</p>
5	<p>Audio IN</p> <p>The 3.5mm audio input receives external audio.</p>
6	<p>RS-422/RS-485 Interface (RJ-45)</p> <p>The RS-485 interface serves to connect external RS-422/RS-485 devices. Use an Ethernet cable to connect external RS-422/RS-485 controllers. See “Section 9 Remote Control Port Pinouts” for making the cable for the RS-422/RS-485 interface.</p> <p>Note: To switch between RS-422 and RS-485 communication protocols, open OSD menu, then go to Setup → RS-485/422 in which you will be allowed to select the appropriate protocol.</p>
7	<p>RS-232 Interface (RJ-45)</p> <p>The RS-232 interface connects PTC-140 to a remote controller or PC for control purpose. Use an Ethernet cable to connect external RS-232 controllers. See “Section 9 Remote Control Port Pinouts” for making the cable for the RS-232 interface.</p>

Bottom of Camera

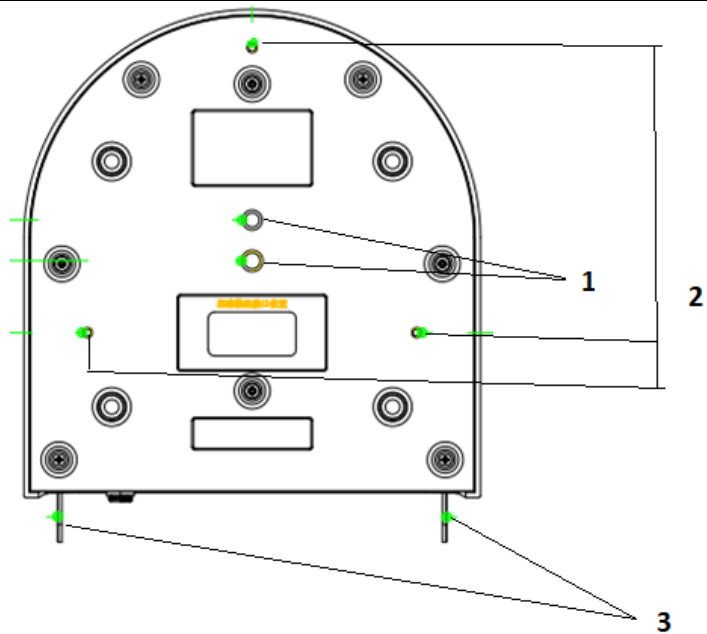

1	Tripod Screw Hole allows the user to mount the camera on the tripod.
2	Screw Hole Screw holes for ceiling bracket mounting.
3	For Safety Rope Ties safety rope for securing the camera to the ceiling.

3. Basic Setup

3.1 Power-On Initialization

As shown in the diagram below, after you plug in the power cord, the tally light in the front will start flashing red and will stop flashing as soon as the power-on initialization is complete. The camera head should be at the HOME position with the lens facing front. However, if preset 0 is set, it will return to the 0th preset position.



Connect the DC 12 V
power adapter

3.2 Video Output

You are allowed to view the camera video via **Ethernet port, HDMI OUT** and **3G-SDI OUT**.

Ethernet Port



Follow the instructions below to view your video on the web user interface.

1. Connect the PTC-140 to the PC/Notebook using an Ethernet cable.
2. On your PC/Notebook, open the web browser and enter the camera's default IP address into the address bar (default static IP address is 192.168.5.163).
3. On the Login page enter the username and password which are admin/admin respectively by default.

4. Click into the preview window on which the video will be displayed.

HDMI Video Output



Connect the HDMI OUT to an external connected monitor using an HDMI cable.

3G-SDI Video Output





Connect the SDI OUT to an external connected monitor using an SDI cable.



4. Remote Control and On-Screen Menu





This chapter provides an overview of remote control functions and the OSD menu.



4.1 Remote Control Functions



No	Function Keys	Descriptions
1	<p style="text-align: center;">Standby Key</p> 	<p>Standby Key The standby button turns ON/OFF the camera.</p> <p>To reboot the camera, press the standby button for 3 seconds. After device initialization is complete, the camera head will automatically return to HOME position.</p>
2	<p style="text-align: center;">Camera Select Keys</p> 	<p>Camera Select Keys To select a camera in a multi-camera environment using camera select keys (CAM1 – CAM4), you should first assign an ID number to the camera intended for operation using F1 – F4 keys then press CAMERA SELECT (CAM 1~ CAM4) keys to navigate between the four cameras.</p> <p>Note: See F1 – F4 keys for ID number assignment instructions.</p>
3	<p style="text-align: center;">Number Keypad</p> 	<p>Number Keypad Set, recall and clear presets using the number keypad.</p> <p>Set Preset Please press the SET PRESET at first, and then please press any of the number keys from 0 to 9 to save the PTZ settings. You will be allowed to save up to up to 10 presets using the remote control.</p> <p>Call Preset Press any of the number keys from 0 to 9 to recall the preset settings. Note: Make sure the preset that you want to recall contains PTZ settings before pressing the number key.</p> <p>Clear Preset First press the CLEAR/PRESET key then the number key (0 – 9) to empty the preset.</p>

No	Function Keys	Descriptions
4	<p data-bbox="221 628 437 683">Asterisk and Pound Keys</p> 	<p data-bbox="468 145 978 233">The asterisk and pound keys form various combinations with other keys to access certain functions directly.</p> <p data-bbox="468 240 844 264">The shortcuts are listed as follows:</p> <ol data-bbox="479 272 986 1246" style="list-style-type: none"> <li data-bbox="479 272 941 296">1. 【#】 + 【#】 + 【#】 : Clear all presets <li data-bbox="479 304 936 368">2. 【*】 + 【#】 + 【6】 : Restore factory defaults <li data-bbox="479 376 941 440">3. 【*】 + 【#】 + 【9】 : Image flip along horizontal axis <li data-bbox="479 448 978 472">4. 【*】 + 【#】 + AUTO: Enable aging mode <li data-bbox="479 480 978 504">5. 【#】 + 【*】 + AUTO: Disable aging mode <li data-bbox="479 512 930 576">6. 【*】 + 【#】 + 【3】 : Set OSD MENU language to Chinese. <li data-bbox="479 584 930 647">7. 【*】 + 【#】 + 【4】 : Set OSD MENU language to English. <li data-bbox="479 655 978 719">8. 【*】 + 【#】 + MANUAL: Restore default user name, password, and IP address. <li data-bbox="479 727 978 791">9. 【#】 + 【#】 + 【0】 : Set video format to 1080P60. <li data-bbox="479 799 978 863">10. 【#】 + 【#】 + 【1】 : Set video format to 1080P50 <li data-bbox="479 871 978 935">11. 【#】 + 【#】 + 【2】 : Set video format to 1080I60 <li data-bbox="479 943 978 1007">12. 【#】 + 【#】 + 【3】 : Set video format to 1080I50 <li data-bbox="479 1015 978 1078">13. 【#】 + 【#】 + 【4】 : Set video format to 720P60 <li data-bbox="479 1086 978 1150">14. 【#】 + 【#】 + 【5】 : Set video format to 720P50 <li data-bbox="479 1158 978 1222">15. 【#】 + 【#】 + 【6】 : Set video format to 1080P30 <li data-bbox="479 1230 978 1294">16. 【#】 + 【#】 + 【7】 : Set video format to 1080P25
5	<p data-bbox="262 1305 396 1329">AUTO Focus</p> 	<p data-bbox="468 1329 605 1353">AUTO Focus</p> <p data-bbox="468 1361 967 1385">Pressing this key will enable auto focus mode.</p>

No	Function Keys	Descriptions
6	<p>Manual Mode</p> 	<p>Manual Focus Pressing this key enables manual mode allowing you to adjust the camera's focus and zoom by pressing Focus+/- and Zoom+/- keys.</p>
7	<p>Focus +/-</p> 	<p>Focus Press and hold Focus+ or Focus- to adjust the focus accordingly and release as soon as the desired focus is reached.</p> <p>Note: Before adjusting the focus using Focus +/- key, press the manual key to enable manual mode.</p>
8	<p>Zoom In (+) / Zoom Out (-)</p> 	<p>Zoom Press and hold Zoom + or Zoom- to zoom in and out respectively and release as soon as the desired zoom is reached.</p> <p>Note: Before adjusting the zoom using Zoom +/- key, press the manual key to enable manual mode.</p>
9	<p>SET PRESET</p> 	<p>SET PRESET Press SET PRESET to set presets. See Number Keypad description for instructions.</p>
10	<p>CLEAR PRESET</p> 	<p>CLEAR PRESET Press CLEAR PRESET to clear presets. See Number Keypad description for instructions.</p>

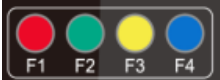
No	Function Keys	Descriptions
11-13	<p>Direction Arrows</p> 	<p>Direction Arrow Keys Press the arrow keys to move the camera head up, down, left and right.</p> <p>Home Key Press Home to return the camera head to the center.</p> <p>Note: In the OSD menu, press Home to enter the selected option item and MENU to exit.</p>
14	<p>MENU</p> 	<p>MENU Open or close the camera's OSD menu.</p>
15	<p>BLC ON/OFF</p> 	<p>BLC ON/OFF Press BLC ON/OFF to turn ON/OFF the backlight compensation.</p>
16	<p>F1 – F4 Keys</p> 	<p>F1 – F4 Keys Assign an ID number to the camera intended for operation using F1 – F4 keys by pressing the combination keys as described below.</p> <ul style="list-style-type: none"> • CAM1: [*] + [#] + [F1] • CAM2: [*] + [#] + [F2] • CAM3: [*] + [#] + [F3] • CAM4: [*] + [#] + [F4] <p>Use Camera Select keys to select the camera intended for operation after you've assigned an ID number to each camera.</p>

Note: Pressing [*] + [#] + MANUAL buttons restores the device's default IP address (192.168.5.163)

4.2 On-Screen Menu

On-Screen Menu allows the user to modify various camera settings. Press **[MENU]** on the **remote control** to open the on-screen menu as shown below.

On-Screen MENU
Language
Setup
Camera
P/T/Z
Video Format
Network Settings
Version
Restore Default
Escape
[↑↓] Select [← →] Change Value
[Menu] Back [Home] OK

The table below summarizes the main option items and their sub-options.

Main Options								
	Language	Setup	Camera	P/T/Z	Video Format	Network Settings	Version	Restore Default
Sub-Options	English	Protocol	Exposure	Zoom by Speed	1080P60	DHCP	MCU Version	Restore Default
	Simplified Chinese	VISCA Address	Color	Zoom Speed	1080P50	IP Addr	Camera Version	
		VISCA Address Fix	Image	Acc Curve	1080I60		AF Version	
		PELCO-P Address	Focus	Preset Speed	1080I50			
		PELCO-D Address	Noise Reduction	Joystic Pan Dir	1080P30			
		Baudrate	Style	Joystic Tilt Dir	1080P25			
		RS-485/422			720P60			
		Tally Light			720P50			
					1080P59.94			
					1080I59.94			
					1080P29.97			
					720P59.94			

Details of all options in the on-screen menu are listed in the table below.

Main Menu	Sub Menu	Options	Sub-options	
Language	English			
	Simplified Chinese			
Setup	Protocol	Auto		
		VISCA		
		PELCOO-D		
		PELCCO-P		
	VISCCA Address	1-7		
	VISCA Address Fix	ON/OFF		
	PELCO-P Address	1-255		
	PELCO-D Address	1-255		
	Baudrate	2400		
		4800		
		9600		
		38400		
		115200		
	RS-485/422	RS-485		
		RS-422		
	Tally Light	RED		
		GREEN		
RED/GREEN				
OFF				
Camera	Mode	Auto		
		Manual		
		SAE		
		AAE		
		Bright		
	EV	ON		
		OFF		
	EV Level	0		
		1		
		2		
		3		
		4		
		5		
		6		
7				
-7				
-6				
-5				

Main Menu	Sub Menu	Options	Sub-options
			-4
			-3
			-2
			-1
		BLC	ON
			OFF
		Flicker	OFF
			50Hz
			60Hz
		Gain Limit	0~15
		DRC	Closed
			1
			2
			3
	4		
	5		
	6		
	7		
	8		
	Color	WB Mode	Auto
			3000K
			3500K
			4000K
			4500K
			5000K
			5500K
			6000K
			6500K
			7000K
Manual			
Onepush			
RG Tuning		0	
		1	
		2	
	3		
	4		
	5		
	6		
	7		
	8		
	9		
	10		
	-10		
	-9		

Main Menu	Sub Menu	Options	Sub-options
			-8
			-7
			-6
			-5
			-4
			-3
			-2
			-1
		BG Tuning	0
			1
			2
			3
			4
			5
			6
			7
			8
			9
			10
			-10
			-9
			-8
			-7
			-6
			-5
		-4	
		-3	
		-2	
		-1	
		Saturation	60%
			70%
			80%
			90%
			100%
			110%
			120%
			130%
			140%
			150%
			160%
			170%
			180%
		190%	
		200%	

Main Menu	Sub Menu	Options	Sub-options	
		Hue	0	
			1	
			2	
			3	
			4	
			5	
			6	
			7	
			8	
			9	
			10	
			11	
			12	
			13	
			14	
			AWB Sensitivity	High
				Low
				Middle
	Image		Brightness	0
				1
				2
				3
				4
				5
				6
				7
				8
				9
				10
				11
				12
13				
14				
			Contrast	0
				1
				2
				3
				4
				5
	6			
7				
			8	
			9	
			10	

Main Menu	Sub Menu	Options	Sub-options
			11
			12
			13
			14
		Sharpness	0
			1
			2
			3
			4
			5
			6
			7
			8
			9
			10
			11
			12
			13
			14
		15	
		Flip-H (The camera image flips horizontally)	ON
			OFF
		Flip-V (The camera image flips vertically)	ON
			OFF
		B & W Mode	Color
			Black & White
		Gamma	Default
			0.45
			0.50
			0.55
			0.63
		DCI	Closed
1			
2			
3			
4			
5			
6			
7			
8			
Focus	Focus Mode	Auto	
		Manual	

Main Menu	Sub Menu	Options	Sub-options
			Onepush
		AF-Zone	Top
			Center
			Bottom
			All
		AF-Sensitivity	High
	Low		
	Middle		
	Noise Reduction	NR-2D	Auto
			OFF
			1
			2
			3
			4
			5
		6	
		7	
		NR-3D	OFF
			1
			2
			3
			4
			5
6			
7			
8			
Dynamic Hot Pixel	OFF		
	1		
	2		
	3		
	4		
5			
Style	Default		
	Normal		
	Clarity		
	Bright		
	Soft		
P/T/Z	Zoom by Speed	ON	When enabled, the camera zoom speeds up and slows down gradually
		OFF	
	Zoom Speed	1	
	2		

Main Menu	Sub Menu	Options	Sub-options
		3	
		4	
		5	
		6	
		7	
		8	
	Acc Curve	Standard	
		Slow	
		Fast	
	Preset Speed	Fast	
		Slow	
		Middle	
Joystick Pan Dir	Positive	Set to negative when the camera is hung on the ceiling or installed upside down.	
	Negative		
Joystick Tilt Dir	Positive	Set to negative when the camera is hung on the ceiling or installed upside down.	
	Negative		
Video Format	1080P60		
	1080P50		
	1080I60		
	1080I50		
	1080P30		
	1080P25		
	720P60		
	720P50		
	1080P59.94		
	1080I59.94		
	1080P29.97		
	720P59.94		
Network Settings	DHCP	ON	
		OFF	
	IP Addr	192.168.x.x	
Version	MCU Version		
	Camera Version		
	AF version		
Restore Default	Restore Default (Yes/No)		

5. How to Use the Tally Light Option in the OSD Menu

The “Tally Light” option in the PTC-140 OSD menu allows you to determine whether the “red” or “green” tally light should be lit when the PTC-140 is connecting to a video switcher (take SHOWCASE 100 as an example). The tally light of the camera will be lit in red or green according to different settings of the switcher’s “PVW (When the PVW is pressed, it will light up in green)” and “PGM (When the PGM is pressed, it will light up in red)” buttons.

At first, please press the “MENU” button which is located on PTC-140’s remote controller to open the OSD menu. After that, please go to “Setup→Tally Light” to select your desired Tally Light setting. There are four kinds of Tally Light options including “RED”, “GREEN”, “RED/GREEN” and “OFF” for your selection.

● When OSD Menu’s “Tally Light” option is set in “RED”

- No input source is selected by the switcher’s “PVW” and “PGM” (take channel 1 as an example), which means that the “PVW” and “PGM” channels are “OFF”. At this time, the camera’s tally light will not be lit. The diagram below is a schematic diagram.

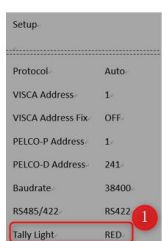

Please select “RED” for the Tally Light option.



Please set the “PGM” and “PVW” to “OFF”.



The Tally light of the camera will not be lit.

- Switcher's "PVW" is set to "ON" and the "PGM" is set to "OFF" (take channel 1 as an example). At this time, the tally light of the camera will not be lit. The diagram below is a schematic diagram.



- Switcher's "PGM" is set to "ON" and the "PVW" is set to "OFF" (take channel 1 as an example). At this time, the tally light of the camera will be lit in red. The diagram below is a schematic diagram.



- Switcher's "PGM" is set to "ON" and the "PVW" is set to "ON" (take channel 1 as an example). At this time, the tally light of the camera will be lit in red. The diagram below is a schematic diagram.



- **When OSD Menu's "Tally Light" option is set in "GREEN"**

- No input source is selected by the switcher's "PVW" and "PGM" (take channel 1 as an example), which means that the "PVW" and "PGM" channels are "OFF". At this time, the camera's tally light will not be lit. The diagram below is a schematic diagram.



- Switcher's "PGM" is set to "OFF" and the "PVW" is set to "ON" (take channel 1 as an example). At this time, the tally light of the camera will be lit in green. The diagram below is a schematic diagram.



- Switcher's "PGM" is set to "ON" and the "PVW" is set to "OFF" (take channel 1 as an example). At this time, the tally light of the camera will not be lit. The diagram below is a schematic diagram.



- Switcher's "PGM" is set to "ON" and the "PVW" is set to "ON" (take channel 1 as an example). At this time, the tally light of the camera will be lit in green. The diagram below is a schematic diagram.



- **When OSD Menu's "Tally Light" option is set in "RED" / "GREEN"**

- No input source is selected by the switcher's "PVW" and "PGM" (take channel 1 as an example), which means that the "PVW" and "PGM" channels are "OFF". At this time, the camera's tally light will not be lit. The diagram below is a schematic diagram.



- Switcher's "PGM" is set to "OFF" and the "PVW" is set to "ON" (take channel 1 as an example). At this time, the tally light of the camera will be lit in green. The diagram below is a schematic diagram.



- Switcher's "PGM" is set to "ON" and the "PVW" is set to "OFF" (take channel 1 as an example). At this time, the tally light of the camera will be lit in red. The diagram below is a schematic diagram.



- Switcher's "PGM" is set to "ON" and the "PVW" is set to "ON" (take channel 1 as an example). At this time, the tally light of the camera will be lit in red. The diagram below is a schematic diagram.



- **When OSD Menu's "Tally Light" option is set in "OFF"**

- No input source is selected by the switcher's "PVW" and "PGM" (take channel 1 as an example), which means that the "PVW" and "PGM" channels are "OFF". At this time, the camera's tally light will not be lit. The diagram below is a schematic diagram.



- Switcher's "PGM" is set to "OFF" and the "PVW" is set to "ON" (take channel 1 as an example). At this time, the tally light of the camera will not be lit. The diagram below is a schematic diagram.



- Switcher's "PGM" is set to "ON" and the "PVW" is set to "OFF" (take channel 1 as an example). At this time, the tally light of the camera will not be lit. The diagram below is a schematic diagram.



- Switcher's "PGM" is set to "ON" and the "PVW" is set to "ON" (take channel 1 as an example). At this time, the tally light of the camera will not be lit. The diagram below is a schematic diagram.

SETUP	
Protocol	Auto
Visca Address	1
Visca Address Fix	OFF
PELCO-P Address	1
PELCO-D Address	241
Baudrate	38400
RS-485/RS-422	RS422
Tally Light	OFF

Please select "OFF" for the Tally Light option



Please select the "PGM" to "ON" and "PVW" to "ON"



The Tally light of the camera will not be lit.

6. Installation Instructions

Note: Only mount the bracket on formwork or concrete surface. Do NOT mount the bracket on plasterboard.

In your product package, you should find

- PM3*5 screw x 6
- Ceiling bracket (upper and lower plates) x 1
- PTC-140 camera x 1

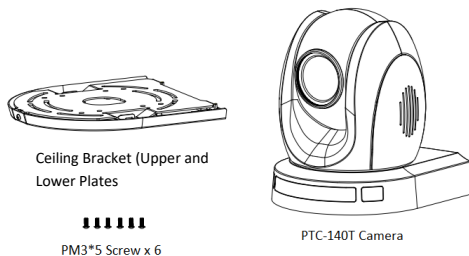

Additionally, you will also need the following to secure the ceiling bracket to the ceiling:

- PA4*30 self-tapping screw x 4
- PA4 plastic screw stopper x 4

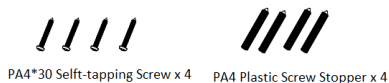

Step 1: The Ceiling Bracket

Separate the ceiling bracket into two parts (upper and lower plates) as depicted in the diagram below.

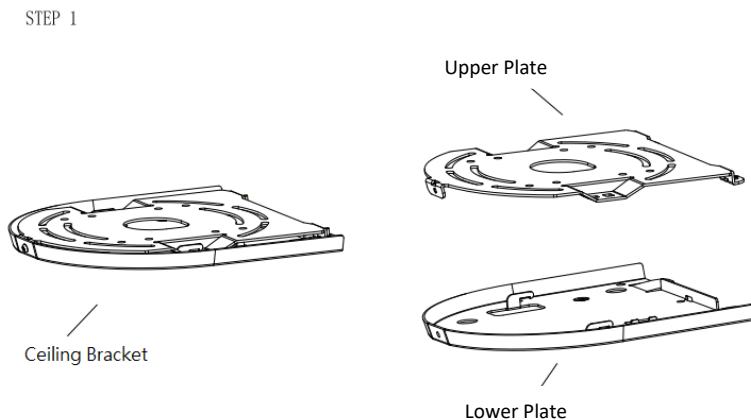

Step 2: Mount the bracket's upper plate to the ceiling

Insert the four PA4 plastic screw stoppers into the ceiling as shown in the diagram below.

Using four PA4*30 self-tapping screws, affix the bracket's upper plate to the ceiling.

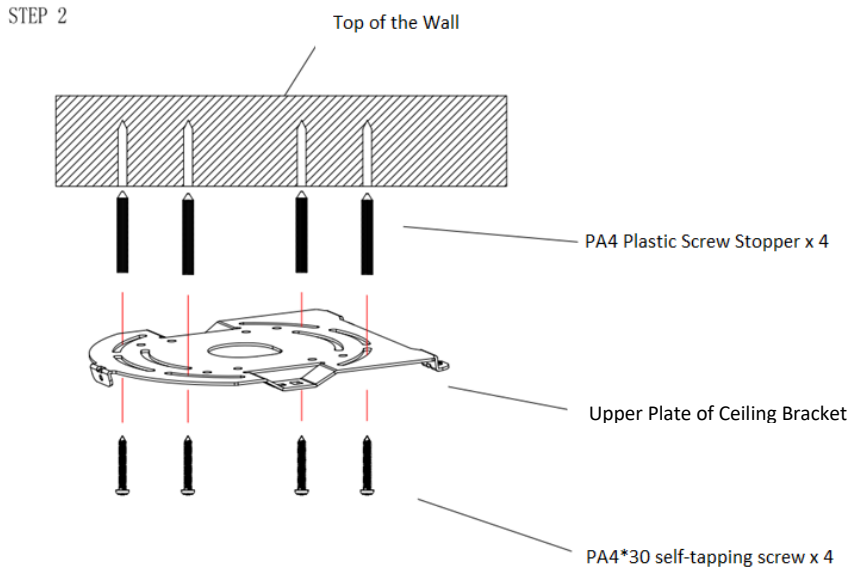

Step 3: Affix the bracket's lower plate to the bottom of PTC-140

As depicted in the diagram below, use three PM3*5 screws to affix the bracket's lower plate to the bottom of PTC-140.

STEP 3

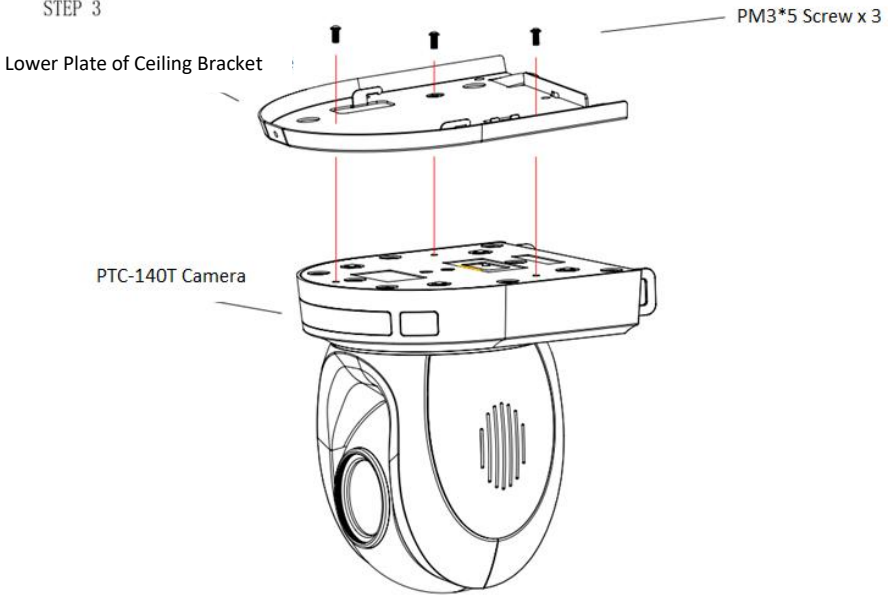

Step 4: Mount the PTC-140 Camera to the ceiling

Now push the PTC-140 camera into the bracket's upper plate in the direction as indicated by the arrow in the diagram below. Make sure the two plates click into place.

Finally, secure the PTC-140 camera to the upper plate with three PM3*5 screws.

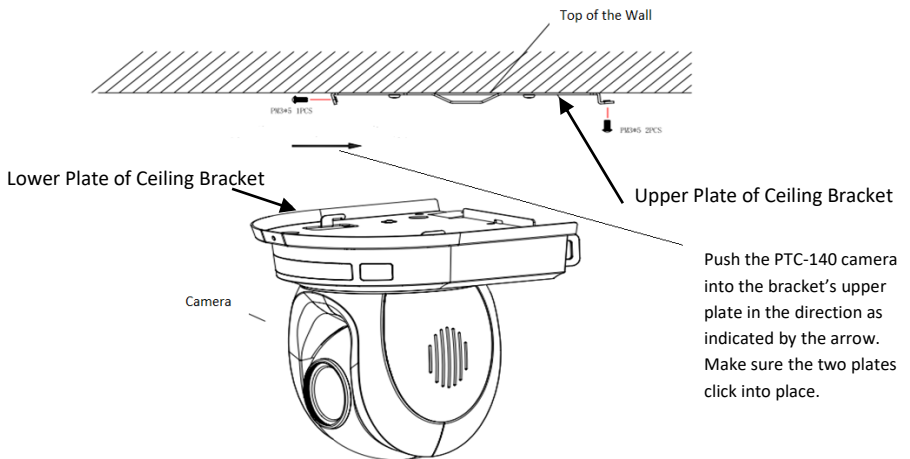

Step 5: Final

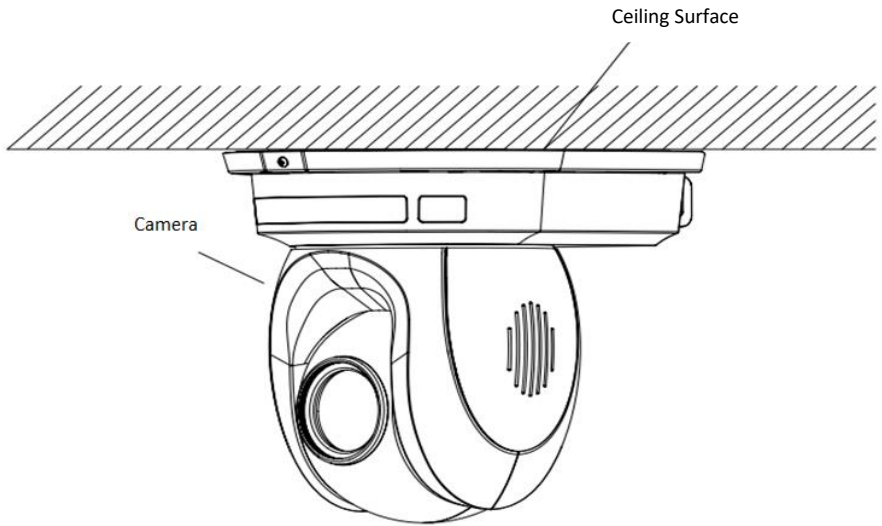

7. Network Connection

The Ethernet port on the back panel of your PTC-140 allows you to connect to the PC/Laptop with a static or dynamic IP address. To access and modify these network settings, you will need to log in to the camera's web interface.

If this is your first time using the device, please note that the camera's default IP address is **192.168.5.163**.

Set up direct connection between the camera and your PC/laptop as depicted in the diagram below; remember to manually assign an IP address of **192.168.5.X** to your PC/laptop.

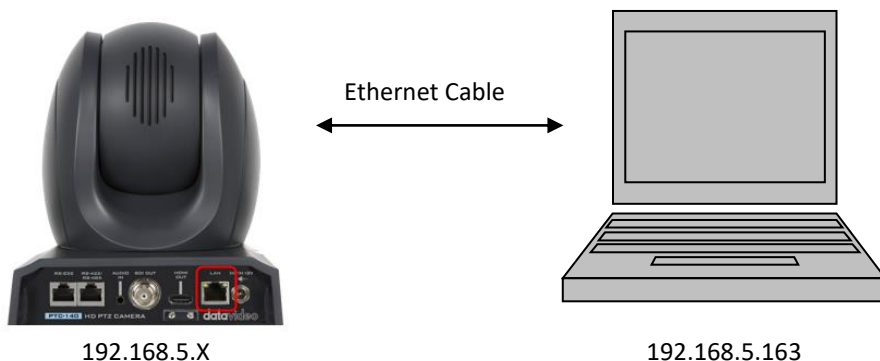

On your PC/laptop, open a web browser and in the address bar, enter the camera's default IP address, 192.168.5.163 then press the **ENTER** key which should take you to login page of the web interface.



The default login credentials are:

- User Name: admin
- Password: admin

After you have successfully logged in to the web interface, you should see the camera video as shown in the diagram below.

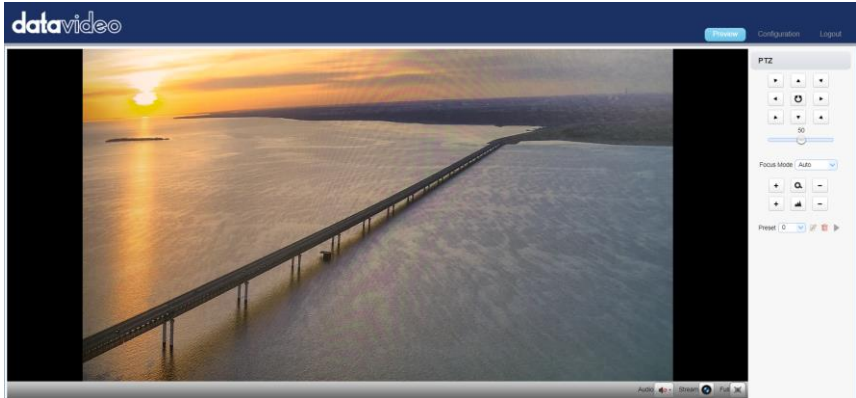

At the top right corner of the web UI, click the Configuration tab to open the Configuration page. On the leftmost pane, click “Network Configure” → “Ethernet” to open the network settings page on which you should be able to see a list of options allowing you to set the camera’s connection mode to DHCP or static IP.

Configurations

- Audio Configure
- Video Configure
 - Video Encode
 - Stream Publish
 - RTP Multicast
 - Video Parameters
 - Video OSD
 - OSD Font Size
 - Video Out
- Network Configure
 - Network Port
 - Ethernet**
 - DNS
 - SRT
- System Configure
 - SystAttr
 - SysTime
 - SysUser
 - Update
 - Default
 - Reboot

Ethernet

DHCP

IP Address

Subnet Mask

Default Gateway

MAC Address

In this chapter, we will show you how to enable DHCP and Static IP modes on PTC-140 in two separate sections.

Note: To log out of the web interface, simply click “Logout” at the top right corner of the page.

7.1 DHCP Mode

Dynamic Host Configuration Protocol (DHCP) is a network protocol that enables a server to automatically assign an IP address to a network device from a defined range of numbers configured for a given network. The diagram below illustrates a DHCP network connection example.

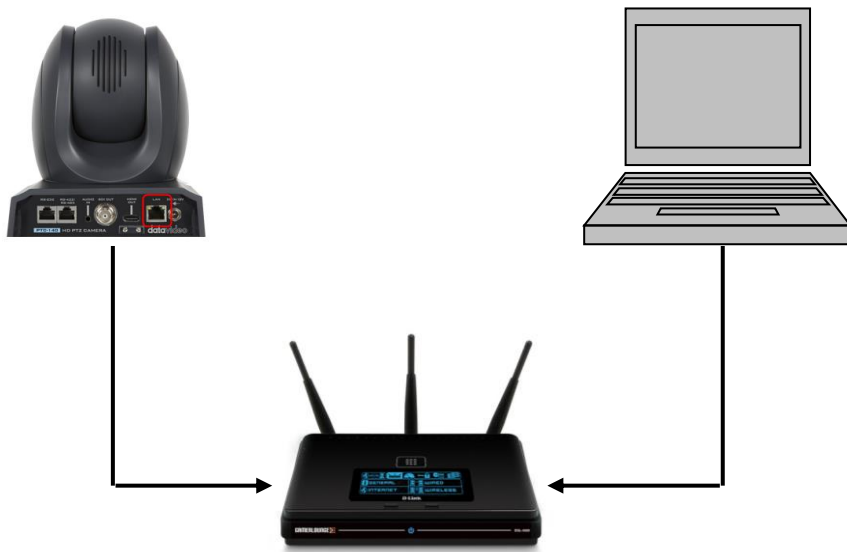

In order to enable the camera’s DHCP mode, log in to the web interface and on the leftmost pane, click “Network Configure” → “Ethernet” to open the network settings page on which you should be able to see a list of options allowing you to set the camera’s connection mode to DHCP or static IP. Then check the DHCP checkbox to allow the router to dynamically assign an IP address to PTC-140T. Please note that the DHCP option in the OSD menu should also be set to ON.

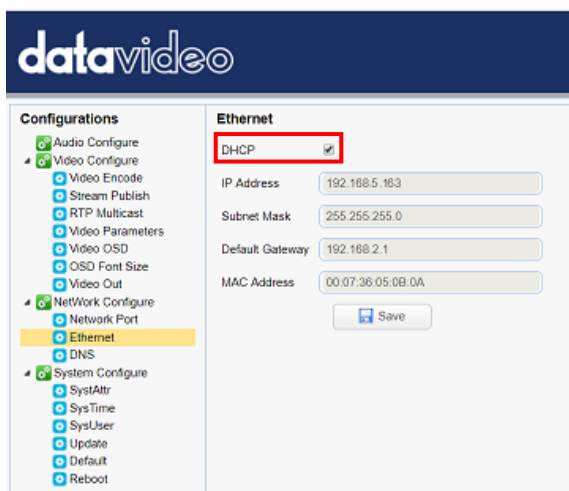

Click the “Save” button to save the new settings then reboot PTC-140.

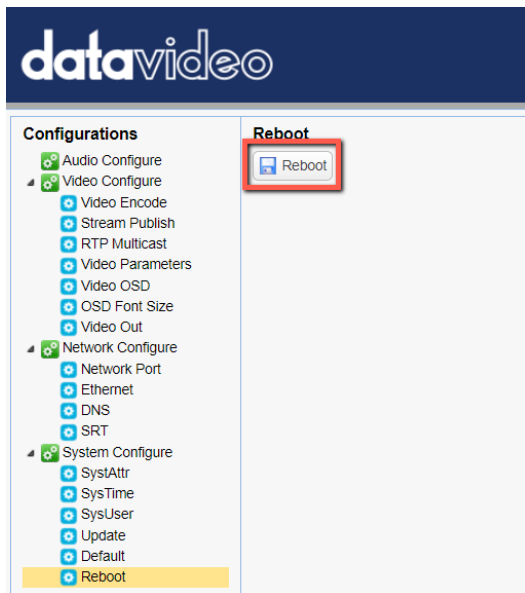

7.2 Static IP

A static IP address is a fixed address manually assigned to PTC-140. First uncheck the DHCP checkbox then enter an IP address for the camera, as well as the subnet mask and the gateway IP.

Note: Never assign an address that ends in .0 or .255 as these addresses are typically reserved for network protocols. An address to the very start of the IP pool is also not recommended as it is always reserved for the router.

After you’ve configured the camera’s static IP mode, click the “Save” button to save the new settings then reboot PTC-140.

7.3 DVIP

DVIP is a network configuration software tool designed for DVIP device search on the same network and configuring device network settings such as Hostname, DHCP mode, IP address, subnet mask, gateway IP, and primary and secondary DNS.

Depending on your operating system, download DVIP Configuration Tool from the respective sites listed as follows:

PC: <https://www.microsoft.com/en-us/p/dvip-network-config/9p6gtz839k6s?activetab=pivot%3Aoverviewtab>

Android:

https://play.google.com/store/apps/details?id=com.datavideo.dvipnetconfig&hl=en_US

iOS: <https://itunes.apple.com/tw/app/dvip-network-config/id1177895983?mt=8>

After you've installed the DVIP Network Configuration Tool, follow the steps outlined below to scan for online DVIP devices and configure their corresponding settings.

Step 1: Open the DVIP Network Configuration Tool then select your PC or laptop's network interface card from the drop-down menu as shown in the diagram below.



Step 2: The DVIP Network Configuration Tool interface is shown below and you should see a list of the connected cameras.

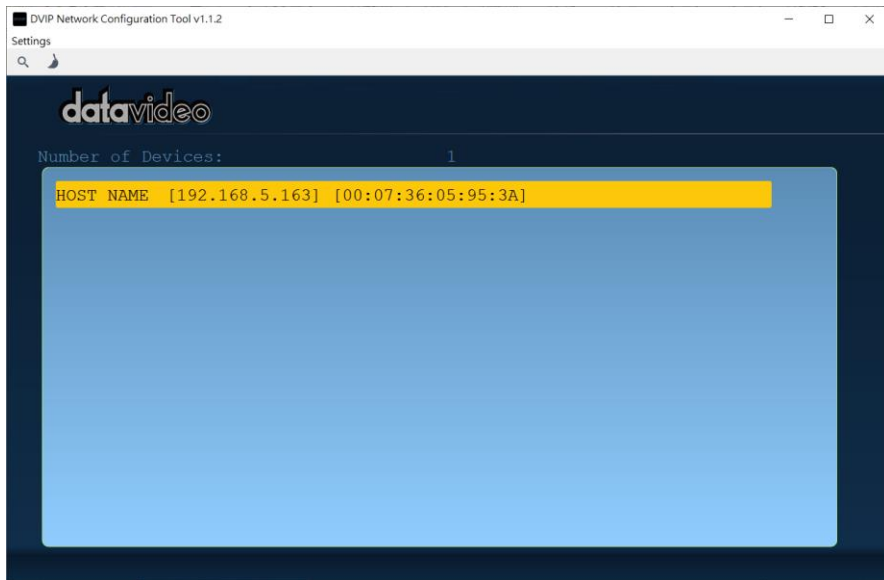

Step 3: Click one of the connected cameras (HOST NAME) to show the device information and its network settings in the pop-up window shown in the diagram below.



Step 4: You are allowed to change the device name in the Host Name field and modify the device's network settings accordingly. To reset, simply click the Default button.

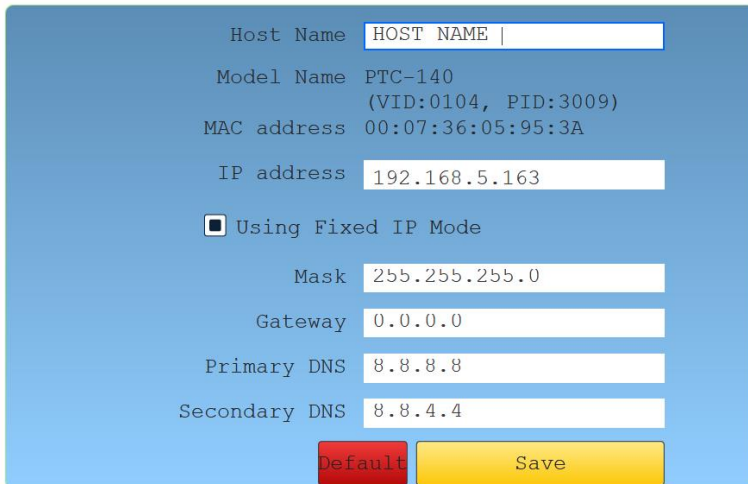

The image shows a network configuration interface on a blue background. It contains several text input fields and a checkbox. At the bottom, there are two buttons: a red 'Default' button and a yellow 'Save' button.

Host Name	HOST NAME
Model Name	PTC-140 (VID:0104, PID:3009)
MAC address	00:07:36:05:95:3A
IP address	192.168.5.163
<input type="checkbox"/> Using Fixed IP Mode	
Mask	255.255.255.0
Gateway	0.0.0.0
Primary DNS	8.8.8.8
Secondary DNS	8.8.4.4

Default Save

8. Web User Interface

The web based user interface allows you to set and control your PTC-140 devices.

8.1 Preview

In preview, you will be able to see the camera image in real time as shown in the diagram below. Click on the preview window once to view in full screen mode and click again to exit.

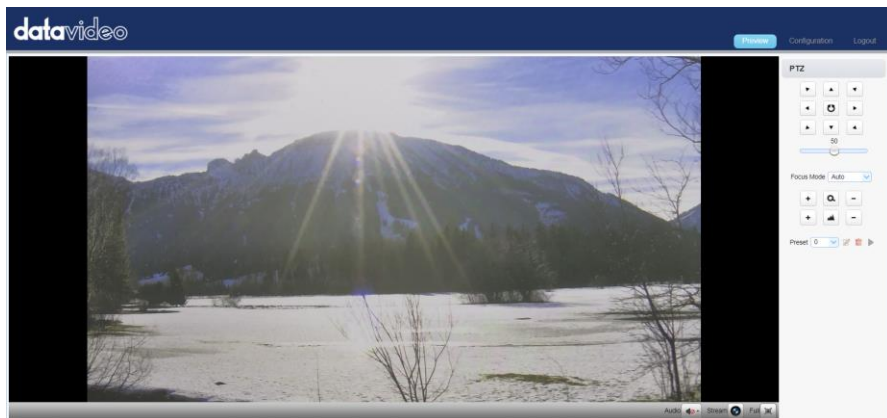

At the bottom right corner of the camera image display window, you should find three buttons, namely, Stream, Audio and Full, which are described below:



Click the **“Stream”** button to switch between Main Stream and Sub Stream previews. See **Video Encode** in **Configuration** tab for stream settings.



Click the **“Audio”** button to turn ON/OFF the sound. See **Audio Configure** for audio settings.









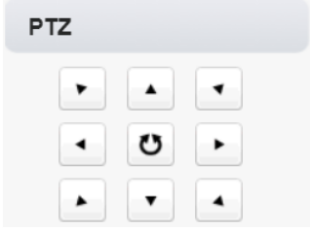

Click the **“Full”** button to switch to the full screen display mode.

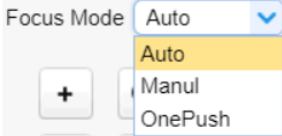
Note: Only H.264 BP and MP video streams can be viewed on the Preview window. H.264 HP and H.265 video streams CANNOT be viewed on the Preview window.

Control Functions





Further to the right, there are various control functions, such as **PTZ control**, **PTZ speed slider**, **focus mode** drop-down menu, **zoom** and **focus** controls, as well as **presets** for saving PTZ settings. Details of each will be described in the table below.

Controls	Descriptions
 <p>The image shows a control panel labeled 'PTZ' with nine directional buttons: up, down, left, right, and a central home button with a circular arrow icon.</p>	<p>PTZ Control Buttons Click the arrow buttons to move the camera head to corresponding directions.</p> <p>To return to Home position, click .</p>
 <p>The image shows a horizontal slider with a circular knob in the center. The number '50' is displayed above the knob.</p>	<p>PTZ Speed Slider The PTZ speed slider adjusts the P/T speed, ranging from 0 (slowest) to 100 (fastest). The default speed is 50. Slide right to increase the speed and left to decrease.</p>
 <p>The image shows a 'Focus Mode' drop-down menu with 'Auto' selected. A '+' button is visible to the left of the menu.</p>	<p>Focus Mode Select focus mode from the drop-down menu; available options are Auto, Manual and One Push. Auto: Automatic focus Manual: Manual focus One Push: One time automatic focus.</p>
 <p>The image shows three buttons: a '+' button, a camera icon, and a '-' button.</p>	<p>Focus Far/Near Click  (FAR) and  (Near) buttons accordingly to manually focus the camera lens onto the subject.</p> <p>Note: You will not be able to manually adjust the camera focus if focus mode is set to Auto or One Push.</p>

Controls	Descriptions
	<p>Zoom IN/OUT</p> <p>Click  to zoom in and  to zoom out.</p>

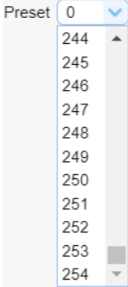
Preset

The presets allow you to save multiple PTZ settings to the camera. See function descriptions in the table below.

Functions	Descriptions
	<p>Preset Drop-Down Menu</p> <p>Select a preset number from the drop-down menu.</p> <p>Note: There are 255 presets ranging from 0 – 254.</p>
	<p>Set Button</p> <p>Click Set button to save PTZ settings to the selected preset number.</p>
	<p>Delete Button</p> <p>Click Clear button to remove PTZ settings from the selected preset number.</p>
	<p>Run Button</p> <p>Click Run button to recall PTZ settings from the selected preset number.</p>

Set the Preset

To set the preset, follow the steps outlined below.

1. First adjust the camera head to the desired **pan** and **tilt** positions.
2. Make sure **zoom** and **focus** are adjusted as well.
3. Select a preset number from the **Preset** drop-down menu.

- Click the Set button to save the PTZ settings to the selected preset number.

Recall the Preset

To recall a saved preset, simply select a preset number from the **Preset** drop-down menu then click the Run button to apply the saved settings.

8.2 Configuration

In **Configuration**, you will be able to configure the camera's audio, video, network and system settings which will be described further in the next few sections.

Audio Configure

Audio Configure allows you to configure the input audio source.

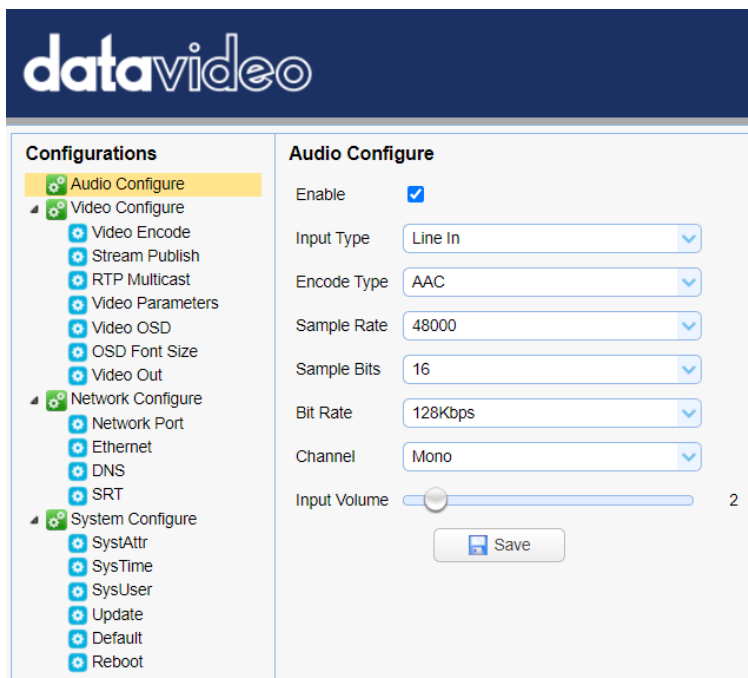

The screenshot displays the DataVideo configuration interface. At the top, the 'datavideo' logo is visible. The interface is divided into two main sections: 'Configurations' on the left and 'Audio Configure' on the right.

Configurations



- Audio Configure (highlighted)
- Video Configure
 - Video Encode
 - Stream Publish
 - RTP Multicast
 - Video Parameters
 - Video OSD
 - OSD Font Size
 - Video Out
- Network Configure
 - Network Port
 - Ethernet
 - DNS
 - SRT
- System Configure
 - SystAttr
 - SysTime
 - SysUser
 - Update
 - Default
 - Reboot

Audio Configure

- Enable:
- Input Type: Line In
- Encode Type: AAC
- Sample Rate: 48000
- Sample Bits: 16
- Bit Rate: 128Kbps
- Channel: Mono
- Input Volume: 2
- Save button

See the table below for descriptions of each item.

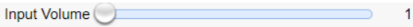
Items	Descriptions
<p>Enable <input checked="" type="checkbox"/></p>	<p>Enable Check this checkbox to enable audio settings.</p>
<p>Input Type: Line In Encode Type: Line In</p>	<p>Input Type This allows users to select the audio input type. It provides Line IN for the audio input type.</p>
<p>Encode Type: AAC MP3 AAC G.711A</p>	<p>Encode Type Select an encode type for your input audio source. The available encode types include MP3, AAC and G.711A.</p>
<p>Sample Rate: 44100 16000 32000 44100 48000</p>	<p>Sample Rate Select a sample rate for your input audio source. The higher the sample rate, the better the audio quality.</p>
<p>Sample Bits: 16 16</p>	<p>Sample Bits Select the sample bits for your input audio source. The default is 16.</p>
<p>Bit Rate: 64Kbps 32Kbps 48Kbps 64Kbps 96Kbps 128Kbps</p>	<p>Bit Rate Select a bit rate for your input audio source. Available bit rates are:</p> <ul style="list-style-type: none"> • 32 Kbps • 48 Kbps • 64 Kbps • 96 Kbps • 128 Kbps

Items	Descriptions
	<p>Channel Set your input audio source to Mono.</p>
	<p>Volume Slider Adjust the volume of your input audio source using the volume slider (Min: 1 / Max: 10).</p>
	<p>Save Button Click the Save button to save the new audio settings.</p>

Video Configure

Video Configure allows you to configure the input video source.

Video Encode

In **Video Encode**, you will be able to configure the video quality for main and sub streams. See the diagram below for various video settings.

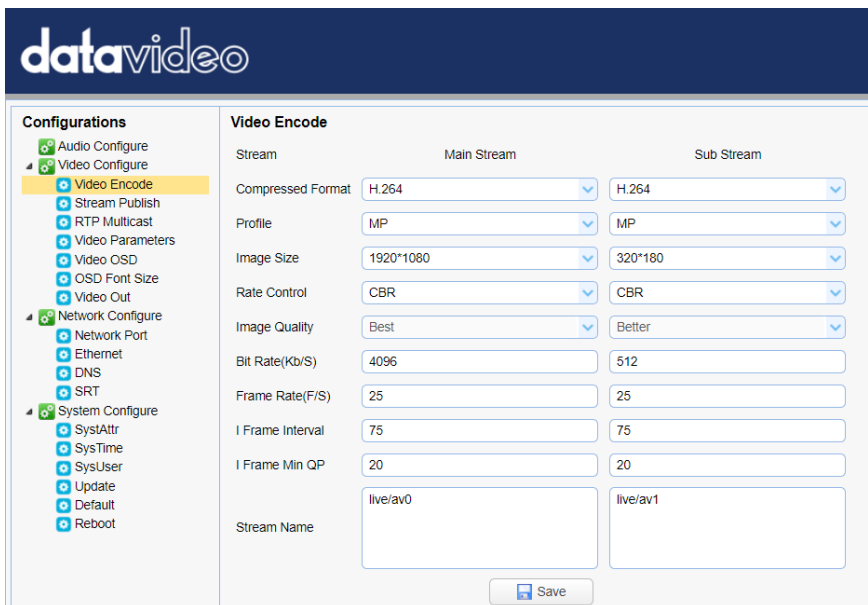

Configurations

- Audio Configure
- Video Configure
 - Video Encode**
 - Stream Publish
 - RTP Multicast
 - Video Parameters
 - Video OSD
 - OSD Font Size
 - Video Out
- Network Configure
 - Network Port
 - Ethernet
 - DNS
 - SRT
- System Configure
 - SystAttr
 - SysTime
 - SysUser
 - Update
 - Default
 - Reboot

Video Encode

Stream	Main Stream	Sub Stream
Compressed Format	H.264	H.264
Profile	MP	MP
Image Size	1920*1080	320*180
Rate Control	CBR	CBR
Image Quality	Best	Better
Bit Rate(Kb/S)	4096	512
Frame Rate(F/S)	25	25
I Frame Interval	75	75
I Frame Min QP	20	20
Stream Name	live/av0	live/av1

Save

See the table below for descriptions of each item.

Items	Descriptions
<p>Compressed Format</p> <p>H.264</p> <p>H.264</p> <p>H.265</p>	<p>Compressed Format</p> <p>Select either H.264 or H.265 video compression.</p>
<p>Profile</p> <p>HP</p> <p>BP</p> <p>MP</p> <p>HP</p>	<p>Profile</p> <p>Select a profile for your input video source. Available profiles are:</p> <ul style="list-style-type: none"> • BP: Baseline Profile (Default) • MP: Main Profile • HP: High Profile
<p>Image Size</p> <p>1920*1080</p> <p>1920*1080</p> <p>1280*720</p> <p>640*480</p>	<p>Image Size</p> <p>Select an appropriate image size from the drop-down menu.</p> <ul style="list-style-type: none"> • 1920 x 1080 • 1280 x 720 • 640 x 480
<p>Rate Control</p> <p>CBR</p> <p>CBR</p> <p>VBR</p>	<p>Rate Control</p> <p>CBR encoding does not optimize media files for quality but will save you storage space. VBR takes longer to encode but produces the most favorable results as the quality of the media file is superior.</p>
<p>Image Quality</p> <p>Best</p>	<p>Image Quality</p> <p>The default image quality for the main stream is “Best.”</p> <p>The default image quality for the sub stream is “Better.”</p>

<p>Bit Rate(Kb/S) <input type="text" value="4096"/></p>	<p>Bit Rate A bitrate is the amount of data required to encode a single second of video. From a streaming perspective, the higher the bitrate, the higher the quality, and the more bandwidth it will require.</p> <p>The default bit rate for the main stream is “4096 Kb/s.”</p> <p>The default bit rate for the sub stream is “512 Kb/s.”</p>
<p>Frame Rate(F/S) <input type="text" value="25"/></p>	<p>Frame Rate Higher frame rate will result in smooth video viewing experience. The frame rate is 25 by default.</p>
<p>I Frame Interval <input type="text" value="75"/></p>	<p>I Frame Interval A shorter I Frame Interval results higher quality video but consumes more network bandwidth. On the other hand if longer I Frame Interval is set, less bandwidth will be required but it will result in lower video quality. I frame interval is 75 by default.</p>
<p>I Frame Min QP <input type="text" value="20"/></p>	<p>I Frame Min QP A low QP value means less compression but higher video quality. The default value is 20.</p>
<p>Stream Name <input type="text" value="live/av0"/></p>	<p>Stream Name Enter a stream name for the main and sub stream.</p>
<p></p>	<p>Save Button Click the Save button to save the new video settings.</p>

Stream Publish

In **Stream Publish**, you will be able to configure the RTMP settings for main and sub streams. See the diagram below for various RTMP settings.

See the table below for descriptions of each item.

Items	Descriptions
<p>Enable <input checked="" type="checkbox"/></p>	<p>Enable Check this checkbox to enable RTMP stream.</p>
<p>Protocol Type <input type="text" value="SRT"/></p> <ul style="list-style-type: none"> RTSP RTMP <li style="background-color: #ffff00;">SRT 	<p>Protocol Type The three available streaming protocols are RTSP, RTMP and SRT.</p>
<p>Host Address <input type="text" value="rtmp://a.rtmp.youtube.com/live2"/></p>	<p>Host Address This is the RTMP/RTSP Server URL provided by video streaming service providers. An example of the RTMP Server URL is provided.</p>

Items	Descriptions
Host Port <input type="text" value="1935"/>	Host Port The host port number is 1935 by default.
Stream Name <input type="text" value="live2/qwqd-5ejj-t73c-0y2g"/>	Stream Name This is the RTMP/RTSP Stream Name/Key provided by video streaming service providers. An example of the RTMP Stream Name/Key is provided.
User Name <input type="text"/> Password <input type="password"/>	User Name / Password Enter the login credentials of the RTSP or RTMP streaming platform.
Password for stream encryption <input type="password" value="*****"/>	Password for Stream Encryption Enter a password for the SRT stream.
Crypto key length in bytes <input type="text" value="32"/> <input type="text" value="0"/> <input type="text" value="16"/> <input type="text" value="24"/> <input type="text" value="32"/>	Crypto Key Length (Bytes) Select an appropriate key length to protect the SRT stream from attacks. You can select 0, 16, 24 or 32 bytes. Note: A 0 byte key means no encryption applied to the SRT stream.
	Save Button Click the Save button to save the new RTMP settings.

Notes:

- 1. The SRT Caller and RTSP Publish modes can only function as the Main Stream encoder.**
- 2. The Sub Stream will be disabled when the SRT Caller or the RTSP Publish functions as the Main Stream encoder.**

Stream to Youtube

In this section, we will show you how to set up an **RTMP(S)** stream to **Youtube**. The step-by-step setup is outlined as follows:

1. First of all, you have to obtain Server URL and Stream Name/Key from Youtube.
2. Open the Youtube Live Dashboard https://www.youtube.com/live_dashboard
3. On the left column, locate and click “**Stream now.**”

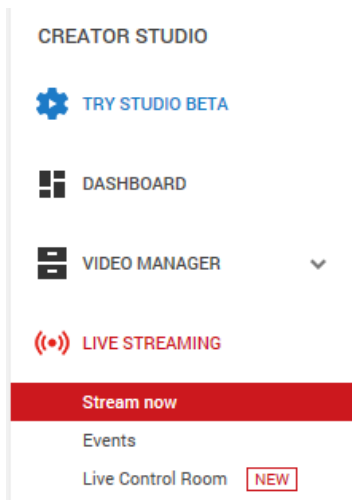

4. On the right, scroll down to the bottom where you will be able to find **Server URL** and **Stream name/key**.

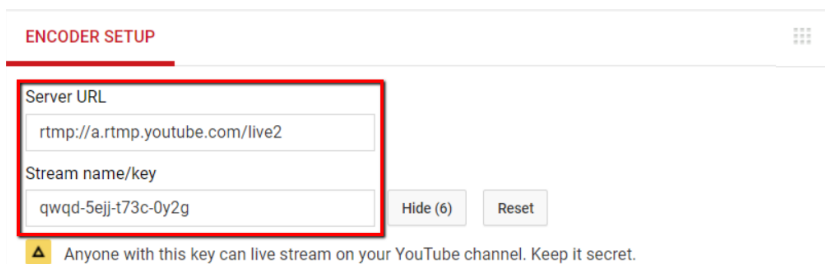

5. Open the PTC-140's web UI and click “**Video Configure**” → “**Stream Publish**”.

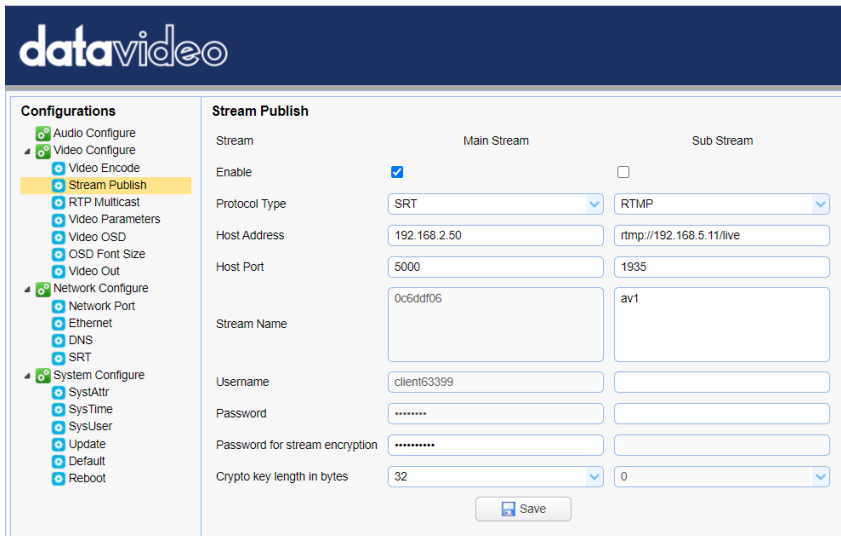

6. Enter the **Server URL** and **Stream Name/Key** into **Host Address** and **Stream Name** respectively.
7. Check the **Enable** checkbox to enable RTMP stream.
8. Click the **Save** button to save the RTMP settings and reboot (System Configure → Reboot) the camera to apply the new settings then you can start broadcasting your camera video on Youtube.

Stream to Facebook

In this section, we will show you how to set up an **RTMP(S)** stream to **Facebook**. The step-by-step setup is outlined as follows:

1. Go to the “[How to go live on Facebook with a camera and streaming software](#)” website by clicking the link below or enter the link address into the address bar of your browser then hit the ENTER key.

Link: <https://www.facebook.com/formedia/solutions/facebook-live>

Click “**Live Producer**” or “**facebook.com/live/producer**” on the page shown below to start the stream setup.

Note: Facebook Live limits each stream to 8 hours.

How to go live on Facebook with a camera and streaming software

Utilize a streaming software.

You'll first need to get set up with streaming software, also referred to as encoding software or an encoder. The encoder that's best for you may depend on the type of content you plan to stream. There are several programs to choose from, including free open-source software. Learn more about encoding software options and going live with streaming software.

Use Live Producer.

Once you have your encoding software and camera installed, you're ready to go live using **Live Producer**, which is the new way to go live on Facebook using higher-end production equipment and streaming software. You can access Live Producer at facebook.com/live/producer.

Learn more about going live.

Learn more about how to use Live Producer here. If you're planning a larger virtual event or show, we also recommend checking out



Alternatively, you can also click the Live Video tab on your personal Facebook page to start the stream setup.



What's on your mind?

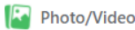
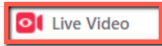

- Click the "Use Stream Key" tab then locate "Server URL" and Stream Key".

- Open the PTC-140's web UI and click "Video Configure" → "Stream Publish"

Configurations	Stream Publish	
	Main Stream	Sub Stream
<ul style="list-style-type: none"> Audio Configure Video Configure Video Encode Stream Publish RTP Multicast Video Parameters Video OSD OSD Font Size Video Out Network Configure Network Port Ethernet DNS SRT System Configure SysAtr SysTime SysUser Update Default Reboot 	Enable <input checked="" type="checkbox"/>	Enable <input type="checkbox"/>
	Protocol Type: SRT	Protocol Type: RTMP
	Host Address: 192.168.2.50	Host Address: rtmp://192.168.5.11/live
	Host Port: 5000	Host Port: 1935
	Stream Name: 0c5ddf06	Stream Name: av1
	Username: client63399	Username:
	Password: *****	Password:
	Password for stream encryption: *****	Password for stream encryption:
	Crypto key length in bytes: 32	Crypto key length in bytes: 0
	<input type="button" value="Save"/>	

4. Enter the **Server URL** and **Stream Key** into **Host Address** and **Stream Name** respectively. Enter 443 into the “Host Port”.
5. Check the **Enable** checkbox to enable RTMP stream.
6. Click the **Save** button to save the RTMP settings and reboot (“**System Configure**” → “**Reboot**”) the camera to apply the new settings.

Reboot
7. After the camera is successfully rebooted, you will see a preview screen appearing at the bottom right corner of the Facebook Live page as shown below.

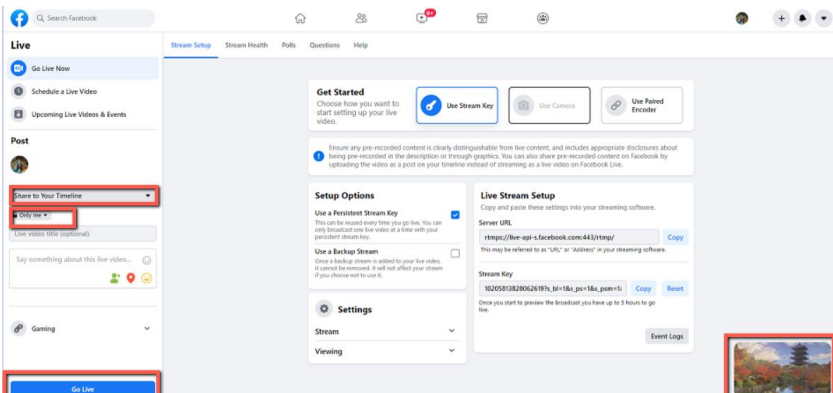

- On the left of the page, first select where you want to stream your live camera video to then select your audience. Finally, enter the title of the live stream and click the **“Go Live”** button to start the stream.
- As soon as the live stream is started, you will be able to view the live camera video on the Facebook Live page. To end, simply click the **“End Live Video”** button.

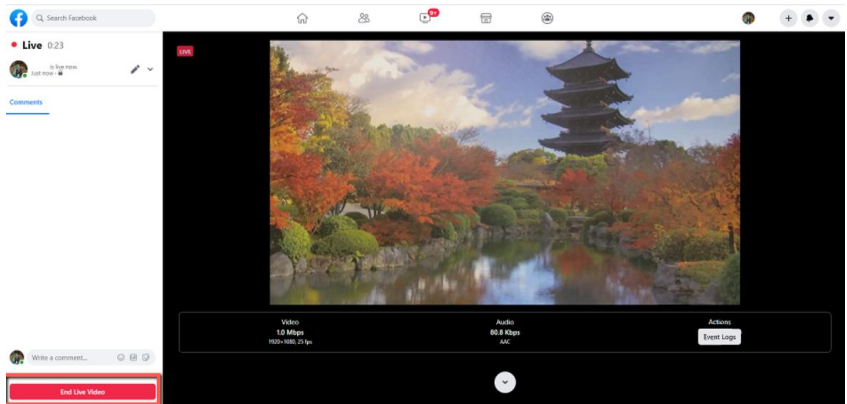

Stream via RTSP to Wowza Streaming Cloud

Wowza Streaming Cloud allows you to easily stream live video to any device. In this section, we will show you how you can stream the PTC-140 camera video to Wowza Streaming Cloud via RTSP.

- First open Wowza’s official website (www.wowza.com) shown below.

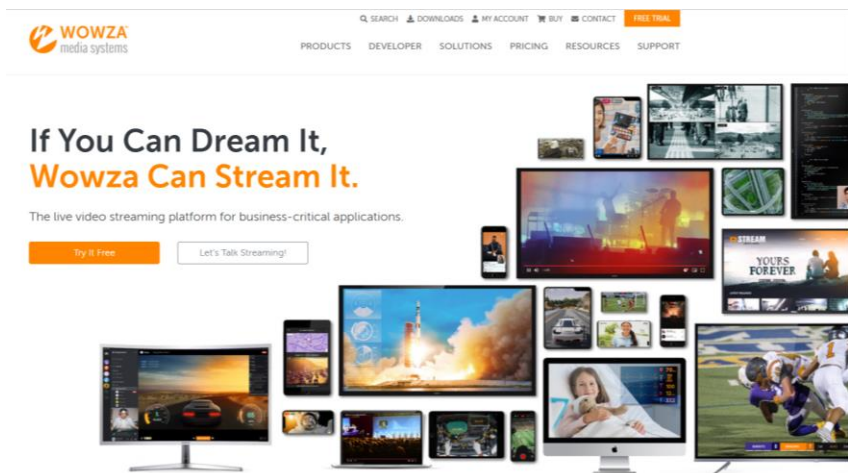

2. Click “MY ACCOUNT” to log in to your Wowza account.

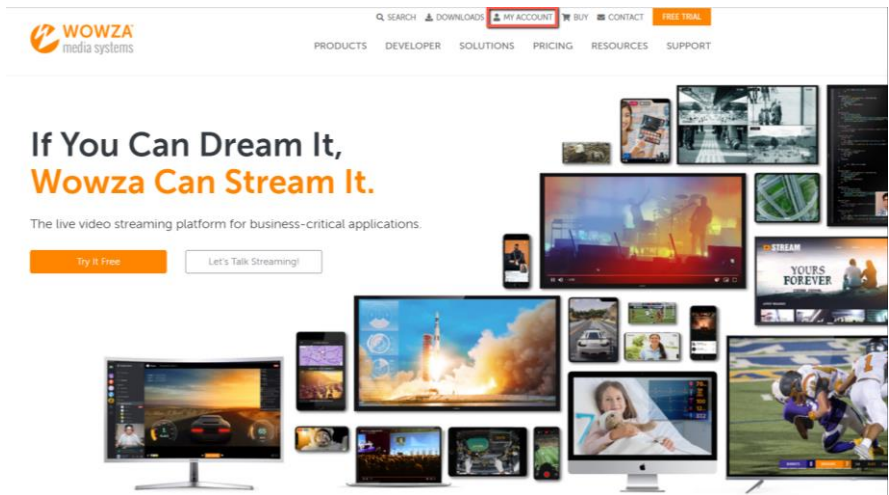

3. If you already have a Wowza account, simply log in with your email address. If you do not have a Wowza account, apply for a 30 day trial account.

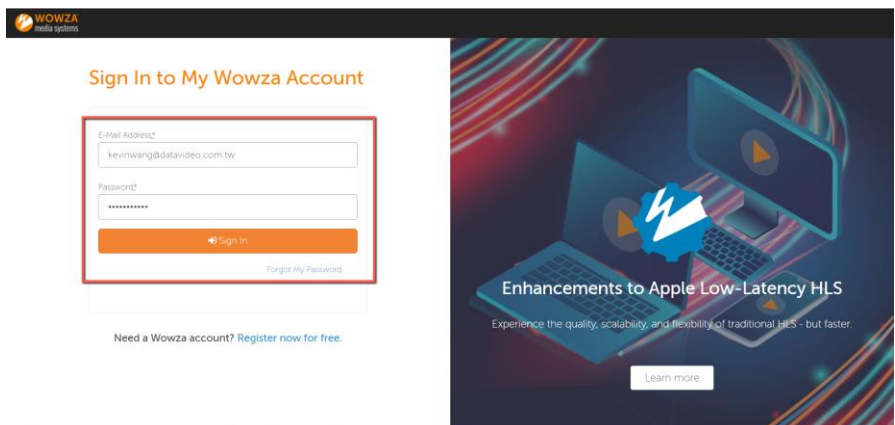

4. We will be using the free trial account in this example, so after login, on the page that opens, click the **FREE TRIAL** button located at the top right corner.

My Account

[Info](#)
[Payment Options](#)
[Orders](#)
[Support](#)
[Products](#)
[Wowza Cloud](#)
[StreamLock](#)

Info [\(edit\)](#)

Account Email: kevinwang@datavideo.com.tw
Company: Datavideo

Contact Information

To change your email address or company name, please [contact us](#).

First Name	Kevin
Last Name	Wang

Password

To change your password, [request a password reset](#).

5. As shown below, click the Free Trial button of Wowza Streaming Cloud.

Select a Wowza Free Trial

Wowza Streaming Cloud

Fully managed cloud service to power live streaming, either end-to-end or as part of a custom streaming platform.

Your free trial includes:

- Fully managed infrastructure.
- Free player and hosted page.
- REST API, Java SDK, and Ruby SDK access.
- 5 hours streaming / 10 connections.

BEST FOR

Deploying quickly on a managed infrastructure

Live event streaming to web or social sites

Building live-streaming apps via GUI or API

Free Trial

[<<> Are you a developer?
Get a Wowza Streaming Cloud Developer Trial](#)

Wowza Streaming Engine

Downloadable server software for live and on-demand streaming: on-premises or in the cloud, fully customizable.

Your free trial includes:

- Windows, Mac, or Linux install.
- Transcoder, nDVR, and more.
- REST and Java API access.
- StreamLock-provisioned SSL certificate for HTTPS and WebRTC streaming
- 3 inbound / 10 outbound connections.

BEST FOR

Self-managed infrastructures

Streaming service providers

Customized streaming solutions

Free Trial

[<<> Are you a developer?
Get a Wowza Streaming Engine Developer Trial](#)

6. Click the “Launch Wowza Streaming Cloud” button.

The screenshot shows the top navigation bar with links for SEARCH, DOWNLOADS, MY ACCOUNT, SIGN OUT, BUY, CONTACT, and FREE TRIAL. Below the navigation is a blue banner with the text "Wowza Streaming Cloud Free Trial". To the left is the Wowza Streaming Cloud logo. To the right is a "Welcome Back, Kevin!" message with a button labeled "Launch Wowza Streaming Cloud". Below the banner, the text "Your Free Trial Includes" is followed by a list of benefits: 30 days of access, unlimited stream starts (15-minute limit), up to 10 concurrent viewers, 3 simultaneous live streams, full REST API access, and Java and Ruby SDK access. Below the list, it says "Complete the form and you will receive a risk-free, 30-day trial account for the Wowza Streaming Cloud service." and "No credit card required. See Wowza Streaming Cloud Terms of Use and Privacy Policy."

7. The UI of Wowza Streaming Cloud is shown in the diagram below. Click “Add Live Stream” to create a live stream channel.

The screenshot shows the Wowza Streaming Cloud user interface. At the top, it says "RUNNING AS A TRIAL" with "22 TRIAL DAYS REMAINING" and a "Buy Now" button. Below this is a navigation bar with "Add Live Stream" (highlighted with a red box), "Monitor", and "Advanced" options. The main content area is divided into "Recent" (with "Add Live Stream" and "No recent live streams") and "Live Streams" (with "There are no live streams to show."). On the right, there is a "Live Streams" help section explaining how to create, view, and edit live streams, and how to search for them.

8. Enter a name for this live stream. As shown in the diagram below, we will use RTSP Stream in this example.

RUNNING AS A TRIAL Trial limitations 22 TRIAL DAYS REMAINING Buy Now

VENICE STREAMING CLOUD Add Live Stream Monitor Advanced Kevin Wang Help All Features Overlaid

ADD LIVE STREAM / Add Live Stream

Recent Add Live Stream

No recent live streams

Add Live Stream: Live Stream Setup

1. Live Stream Setup 2. Video Source and Transcoder Settings 3. Playback Settings 4. Social Page Settings 5. Review Settings

What is the name of your live stream?
RTSP Stream

Which location is closest to where you're broadcasting from?
This location supports 24x7 streaming. This location supports 4K streaming.

Asia Pacific (Australia)	Asia Pacific (India)	Asia Pacific (Japan)
Asia Pacific (Korea)	Asia Pacific (Singapore)	Asia Pacific (Taiwan)
EU (Belgium)	EU (Germany)	EU (Ireland)
South America (Brazil)	US Central (Owens)	US East (S. Carolina)
US East (Virginia)	US West (California)	US West (Oregon)

Next

© 2013-2024 Venice Media Systems™, LLC. All rights reserved. Privacy Policy Legal Notice System Status

VENICE MEDIA SYSTEMS

- Select a location that is nearest to you. In this example, we will select “Asia Pacific Taiwan”, then click the Next button.

RUNNING AS A TRIAL Trial limitations 22 TRIAL DAYS REMAINING Buy Now

VENICE STREAMING CLOUD Add Live Stream Monitor Advanced Kevin Wang Help All Features Overlaid

ADD LIVE STREAM / Add Live Stream

Recent Add Live Stream

No recent live streams

Add Live Stream: Live Stream Setup

1. Live Stream Setup 2. Video Source and Transcoder Settings 3. Playback Settings 4. Social Page Settings 5. Review Settings

What is the name of your live stream?
RTSP Stream

Which location is closest to where you're broadcasting from?
This location supports 24x7 streaming. This location supports 4K streaming.

Asia Pacific (Australia)	Asia Pacific (India)	Asia Pacific (Japan)
Asia Pacific (Korea)	Asia Pacific (Singapore)	Asia Pacific (Taiwan)
EU (Belgium)	EU (Germany)	EU (Ireland)
South America (Brazil)	US Central (Owens)	US East (S. Carolina)
US East (Virginia)	US West (California)	US West (Oregon)

Next

© 2013-2024 Venice Media Systems™, LLC. All rights reserved. Privacy Policy Legal Notice System Status

VENICE MEDIA SYSTEMS

10. Select the camera or the encoder that you want to use to connect to Wowza Streaming Cloud. This example uses RTSP so click “Other RTSP” as shown in the diagram below. The rest of the options can be kept as default values. Finally, click the “Next” button.

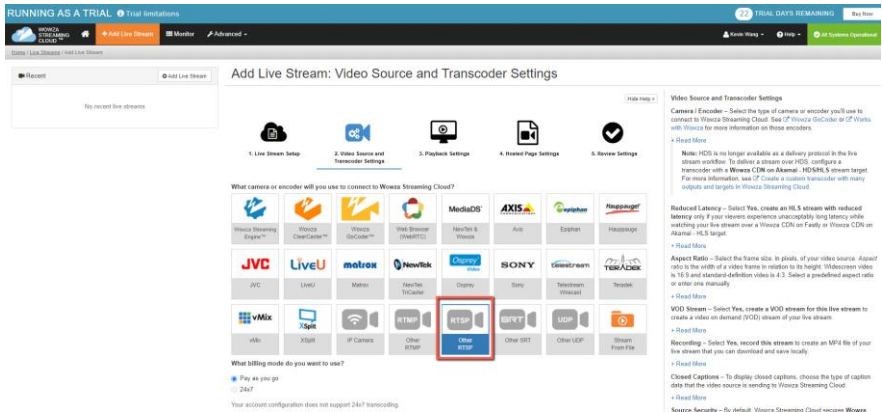

What billing mode do you want to use?

- Pay as you go
- 24x7

Your account configuration does not support 24x7 transcoding.

What type of live stream is this?

- Adaptive bitrate
- Passthrough

Your account configuration does not support Pay-As-You-Go passthrough transcoding.

Do you want to push or pull your stream?

Select *Push Stream* if your camera or encoder will push the stream to Wowza Streaming Cloud. Select *Pull Stream* if your camera or encoder requires Wowza Streaming Cloud to pull the stream.

Do you want to create a reduced-latency HLS stream?

- Yes, create an HLS stream with reduced latency
Select this option only if viewers experience unacceptably long latency and you understand that playback might be affected on some older devices.

Aspect Ratio: 16:9 (Widescreen)

1280 x 720

This setting creates 5 bitrate renditions.

Do you want to create a VOD stream for this live stream?

- Yes, create a VOD stream for this live stream

Do you want to record this live stream?

- Yes, record this live stream

What type of closed captions does this stream have?

None

Source Security

- Disable authentication
Select to disable authentication on the video source

11. Configure your player on this page. Click “Next” after it’s done.

12. On the Hosted Page setup page, enter the page title then click Next.

13. Check your live stream setup and click Finish if all settings are correct.

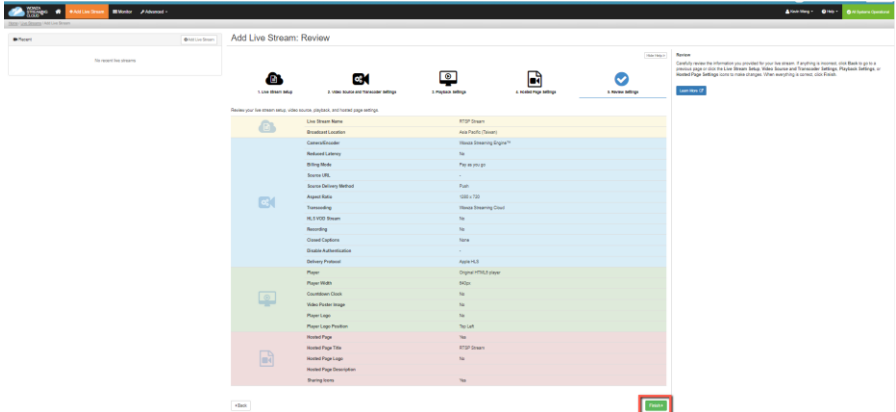

14. Set up the RTSP encoder on the PTC-140.

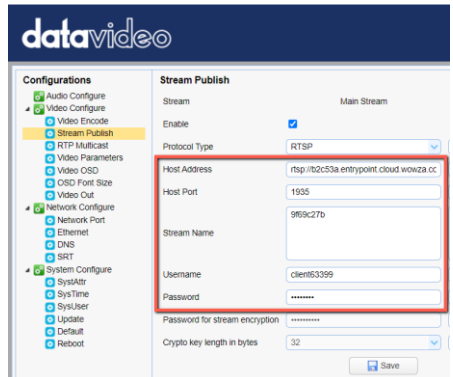
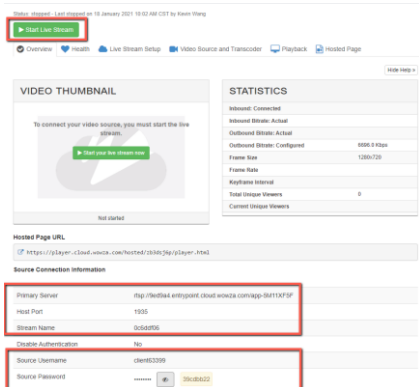

Replicate the following source connection information provided by Wowza to the corresponding fields of the RTSP encoder on your PTC-140.

Source Connection Information	RTSP Encoder (PTC-140)
Primary Server	Host Address
Host Port	Host Port
Stream Name	Stream Name
Source Username	Username
Source Password	Password

After all fields are entered with the respective information, click the **Save** button to save the RTSP settings and reboot (System Configure → Reboot) the camera to apply the new settings.

- Finally, click the “Start Live Stream” button on Wowza Streaming Cloud and you should see the prompt message below. Click Start.

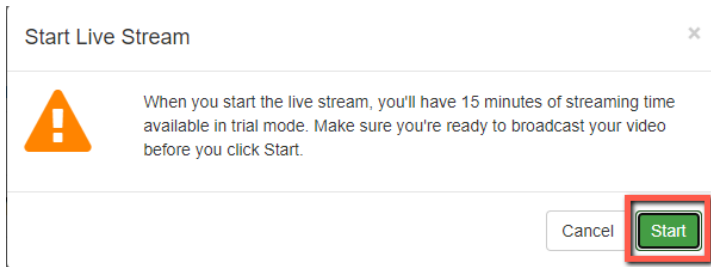

- As shown in the diagram below, your PTC-140 camera video is now successfully being streamed to Wowza Streaming Cloud via RTSP.

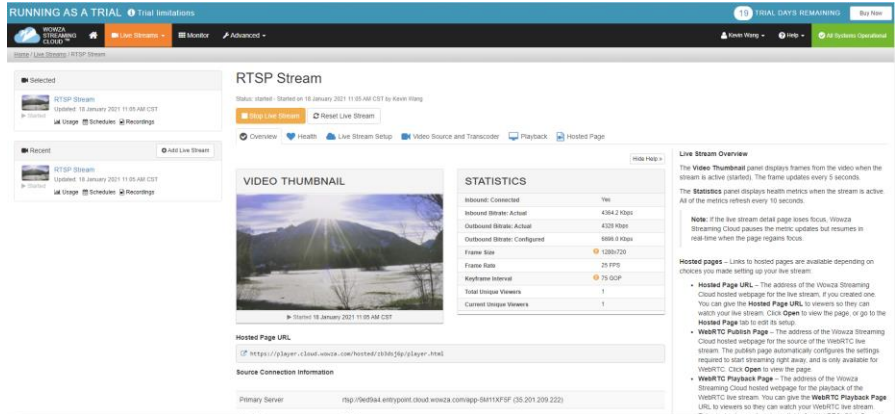

SRT Streaming using the vMix Software

In this section, we will show you how you can stream your camera video via SRT using the vMix Software.

Install the vMix Software

Follow the steps outline below to install the vMix software.

- Download the 60 day free trial version from the vMix official website to your PC or laptop.

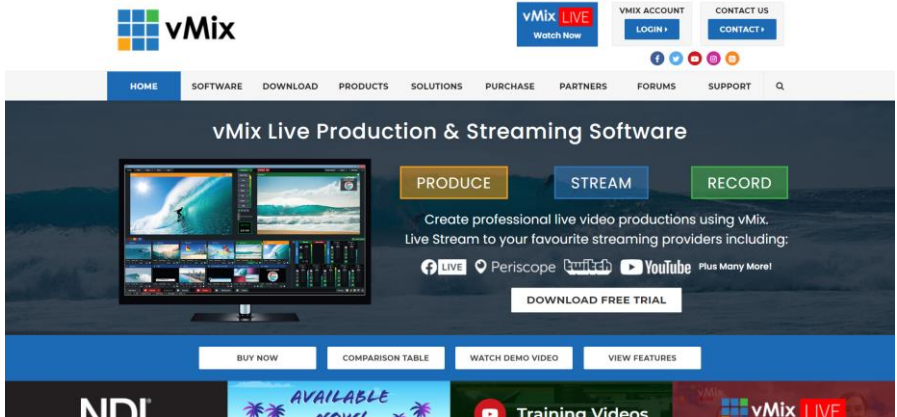

vmix23 2. Double click the installer icon (vmix23.exe).

3. Click Next.

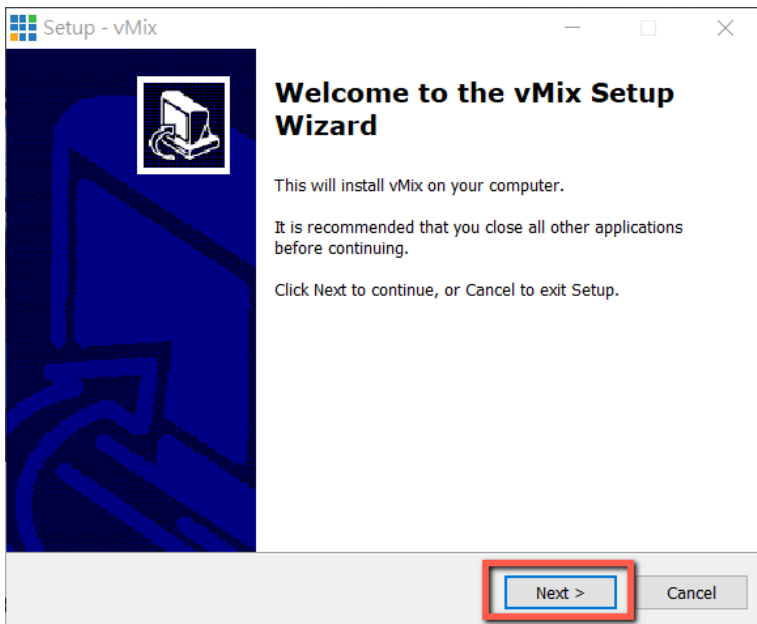

4. Accept the agreement then click Next.

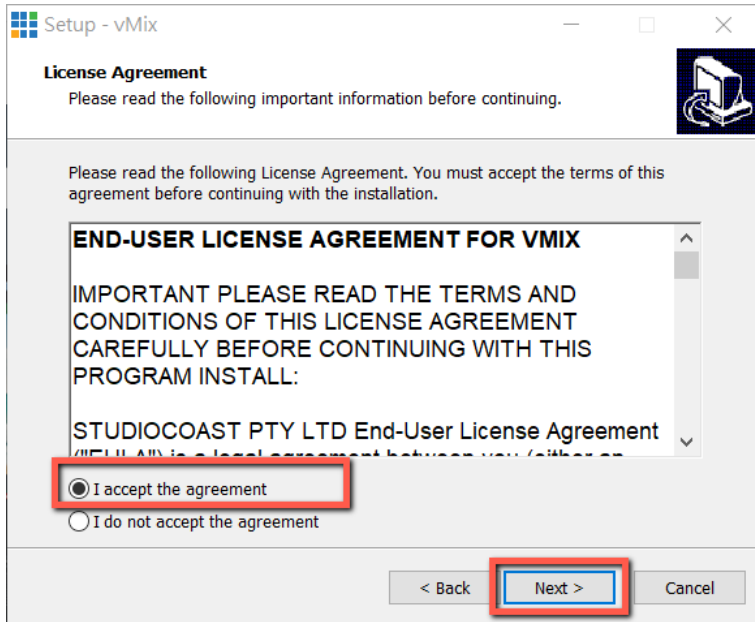

5. Click Next.

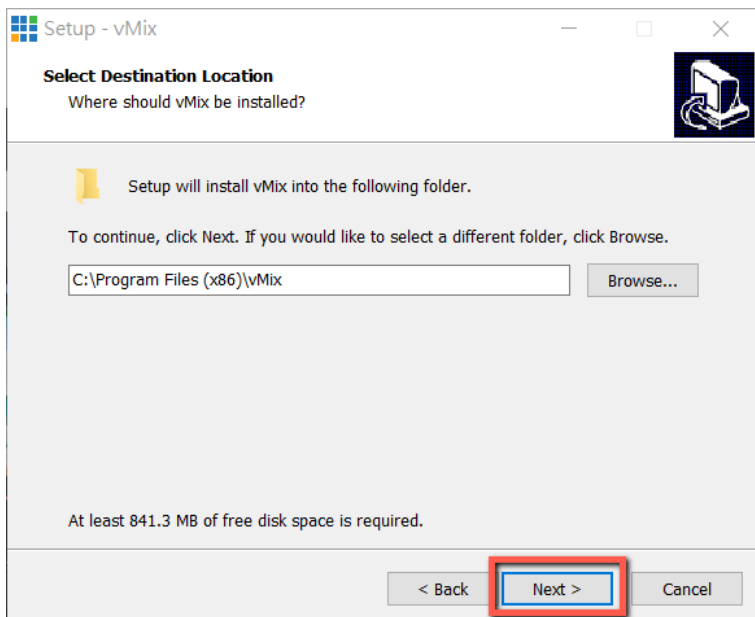

6. Click Next.

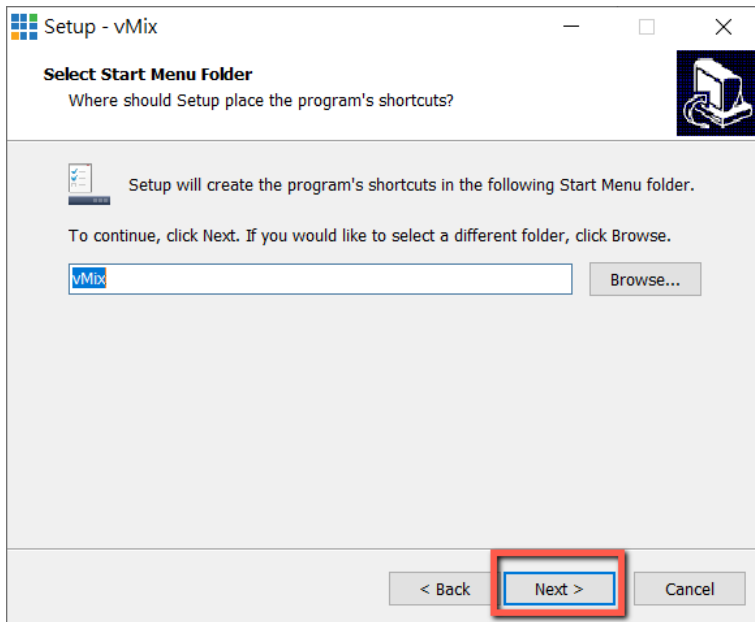

7. Click Next.

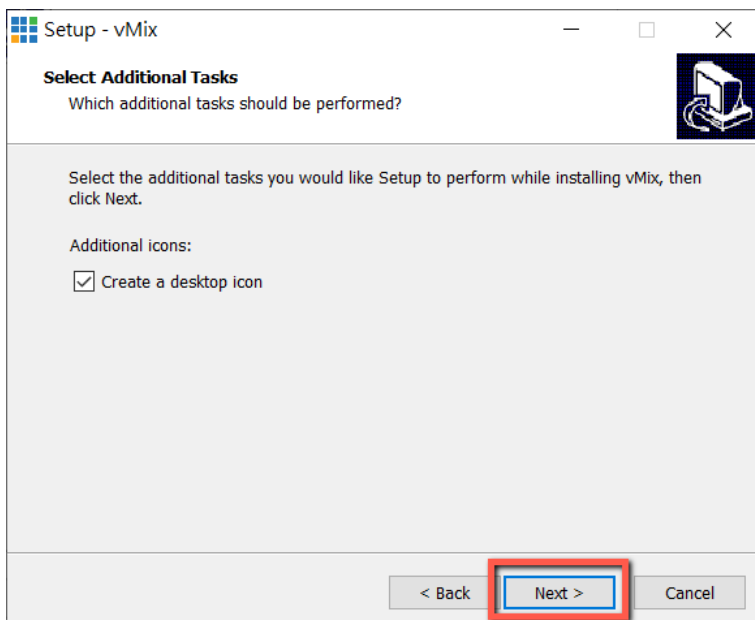

8. Click Next.

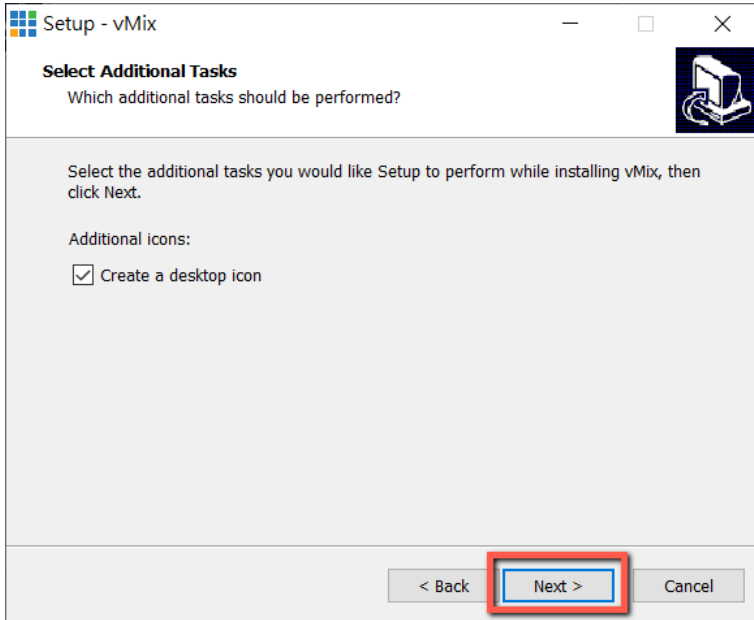

9. Installing

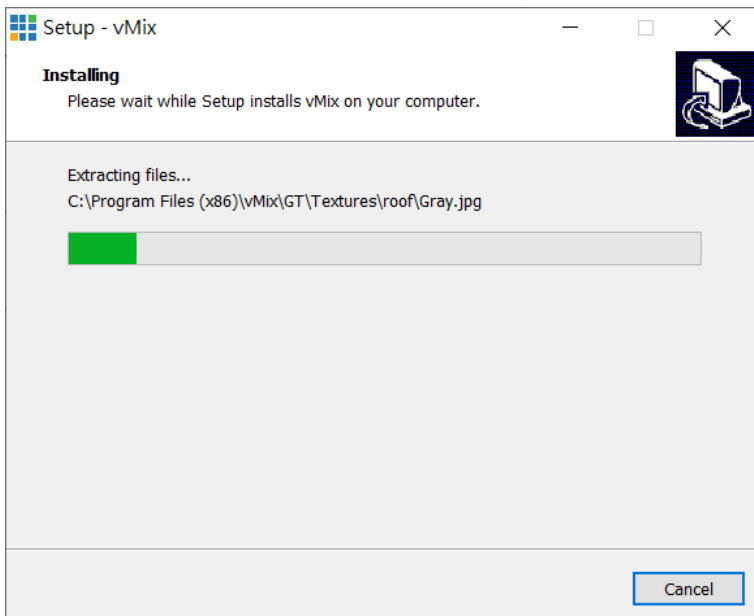

10. Click Finish to complete the setup.

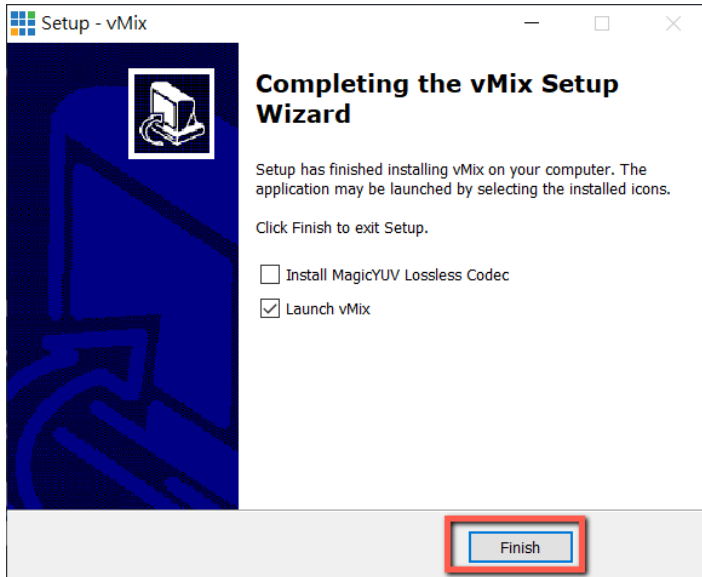

11. Remember to register for a fully functional 60 Day Trial with your e-mail address. After that, click OK.

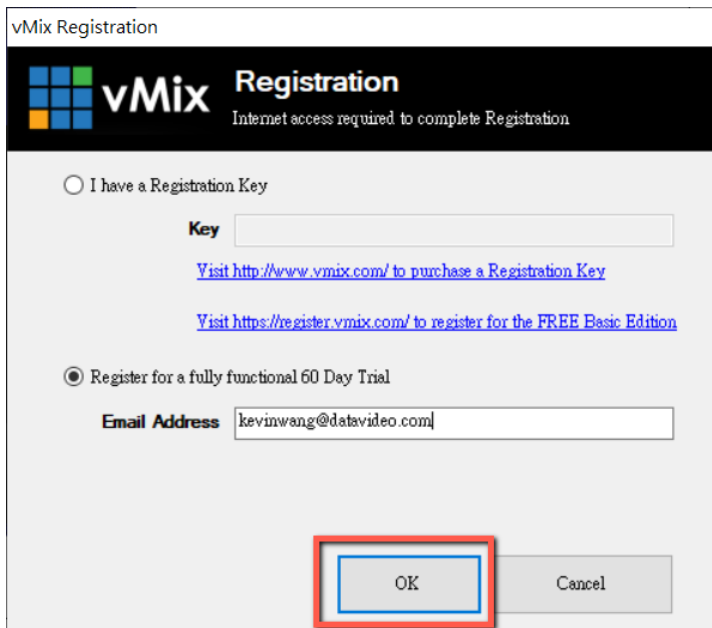

12. Select the initial resolution and frame rate then click OK.

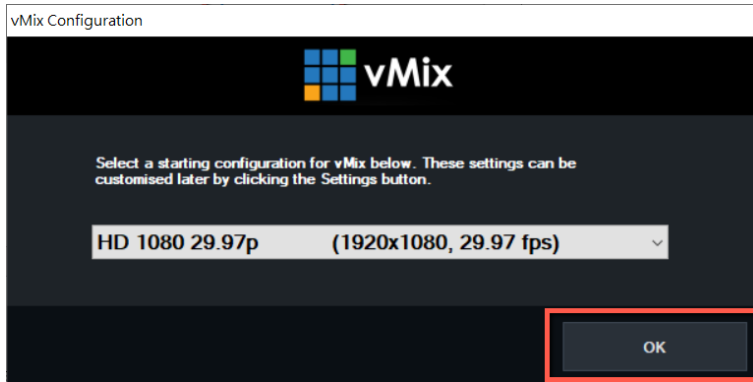

13. The vMix software interface is shown below.

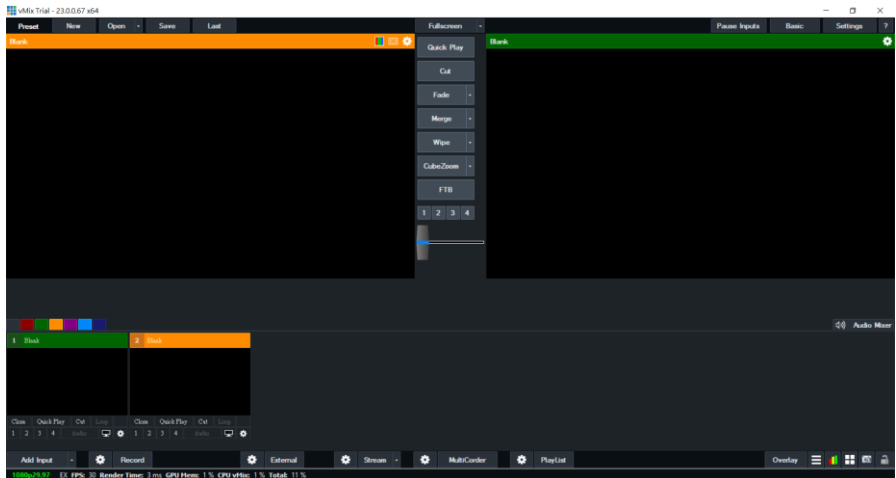

SRT Stream Setup using PTC-140 and vMix

The PTC-140/vMIX connection is bidirectional. Depending on the caller-listener setup, either end can be the camera video source.

PTC-140 set to the Listener Mode

Open the web UI of the PTC-140 then click Network Configure → SRT. Use the default SRT port (9000) then set the password of your SRT stream as well as the crypto key length. In this example, the crypto key length is set to 32 bytes and the password is “8888888888”. click the **Save** button to save the SRT listener settings.

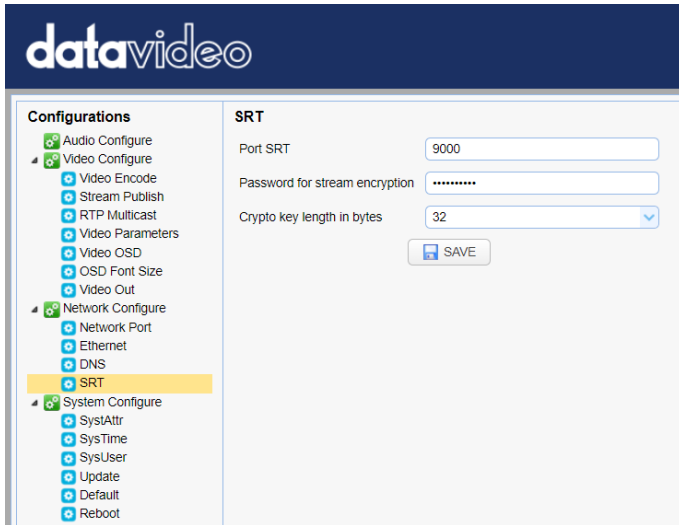

Reboot (System Configure → Reboot) the camera to apply the new settings.

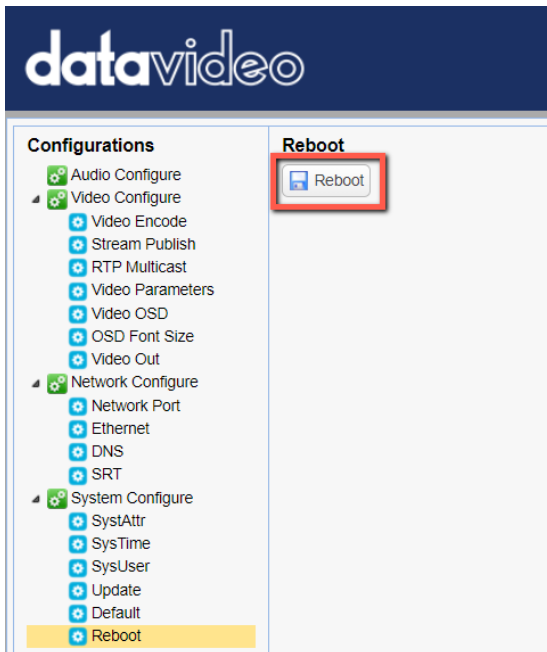

On the PC or laptop where the vMIX is installed, click Start Menu → vMix(x64) and you should see the interface below after the vMIX is opened.

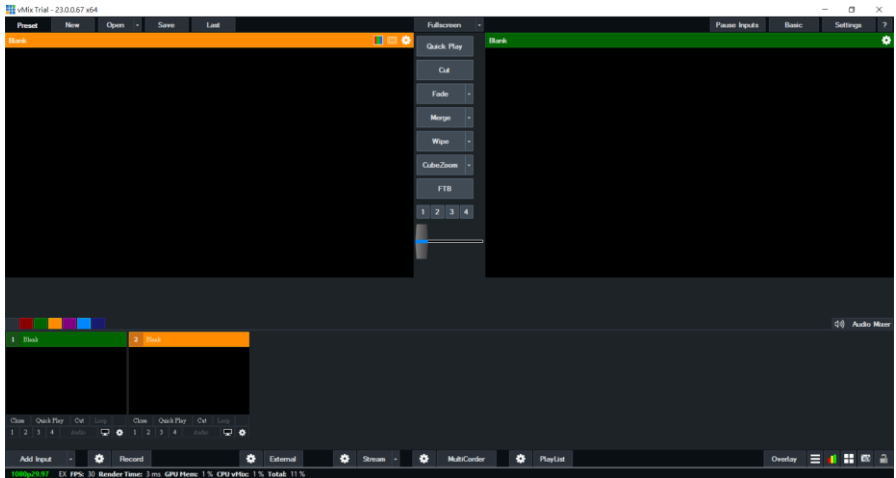

Click “Add Input” then “More”.

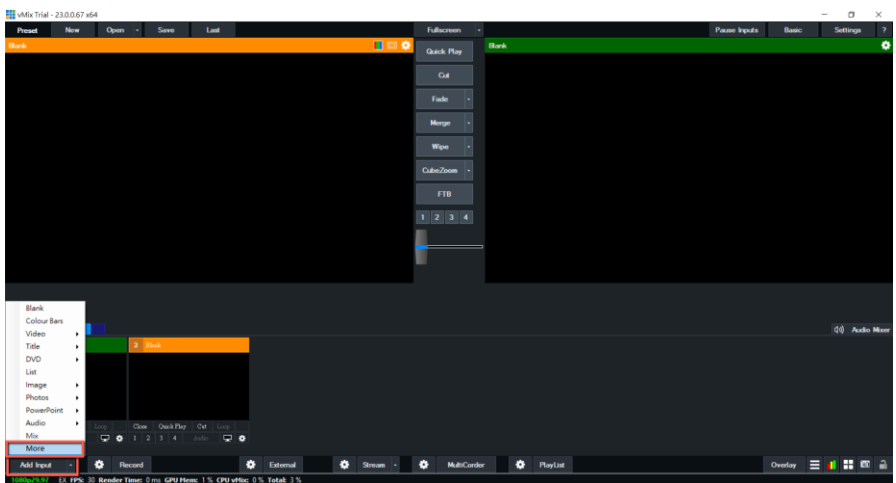

On the Input Select window, click “Stream/SRT” then select “SRT Caller” from the “Stream Type” drop-down menu. After that, enter the following into the respective fields.

- Hostname: 192.168.2.5 (The IP address of your connected device. In this case, it is the PTC-140)
- Port: 9000
- Passphrase: 8888888888 (The password set previously on the PTC-140’s Web UI)

- Key length: 32 (The same length as the key length set previously on the PTC-140's Web UI)

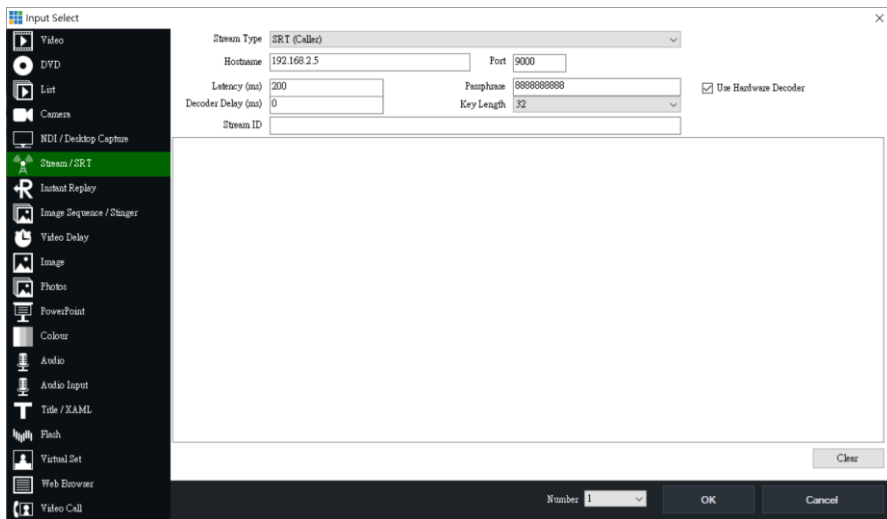

Click the “OK” button.

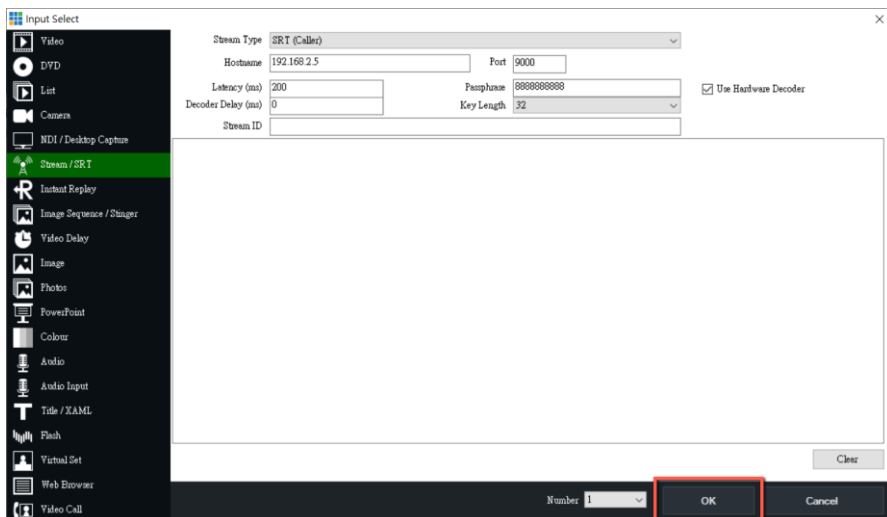

The PTC-140 camera video is now successfully streamed to the vMix via SRT.

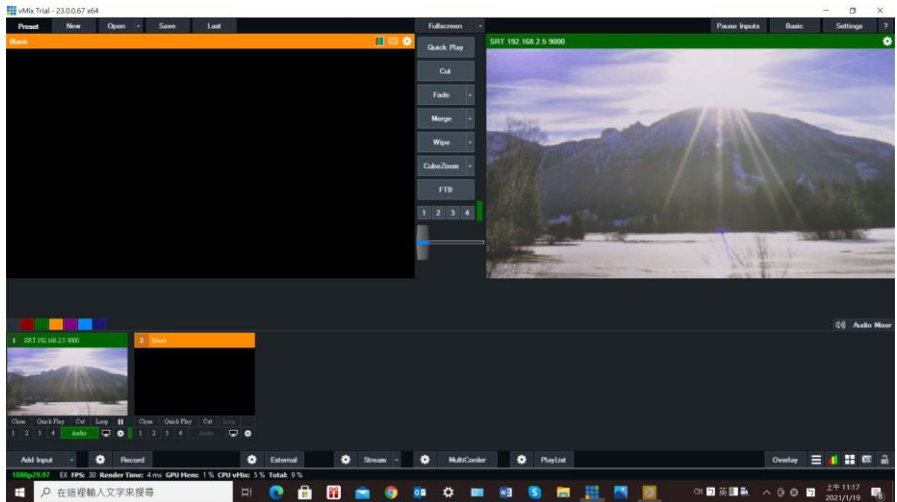

PTC-140 set to the Caller Mode

Open the web UI of the PTC-140 then click **Stream Publish**.

Set the protocol type to SRT then enter the following into the respective fields.

- Host Address: 192.168.2.50 (IP address of the PC/laptop on which the vMIX is installed)
- Host Port: 5000
- Crypto Key Length: 32
- Password for Stream Encryption: 8888888888 (Please note that the password is arbitrary)

Click the **Save** button to save the SRT caller settings.

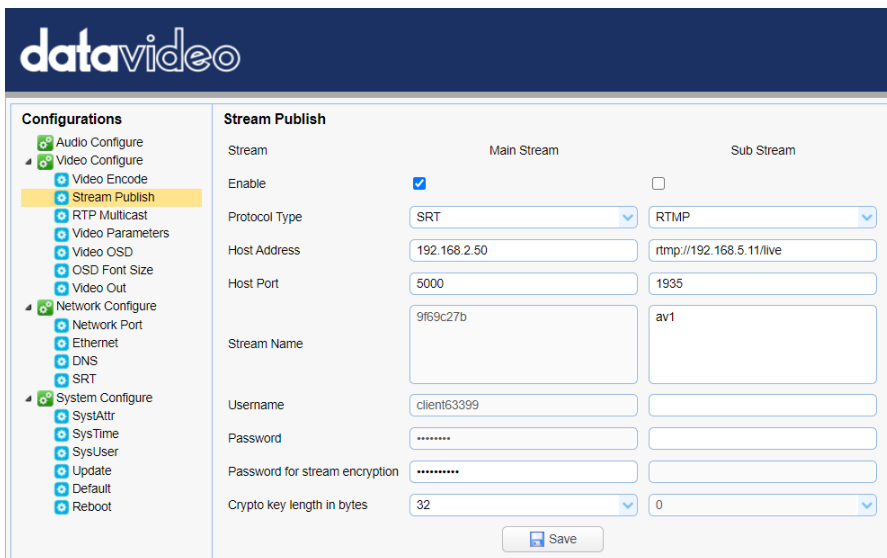

Reboot (System Configure → Reboot) the camera to apply the new settings.

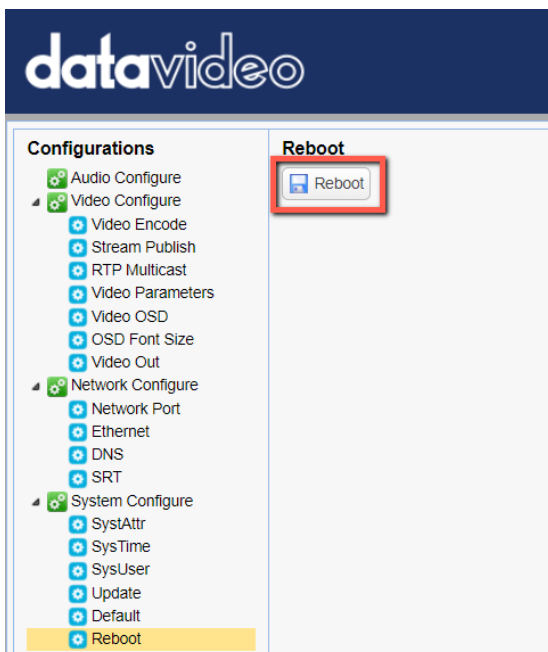

On the PC or laptop where the vMIX is installed, click Start Menu → vMix(x64) and you should see the interface below after the vMIX is opened.

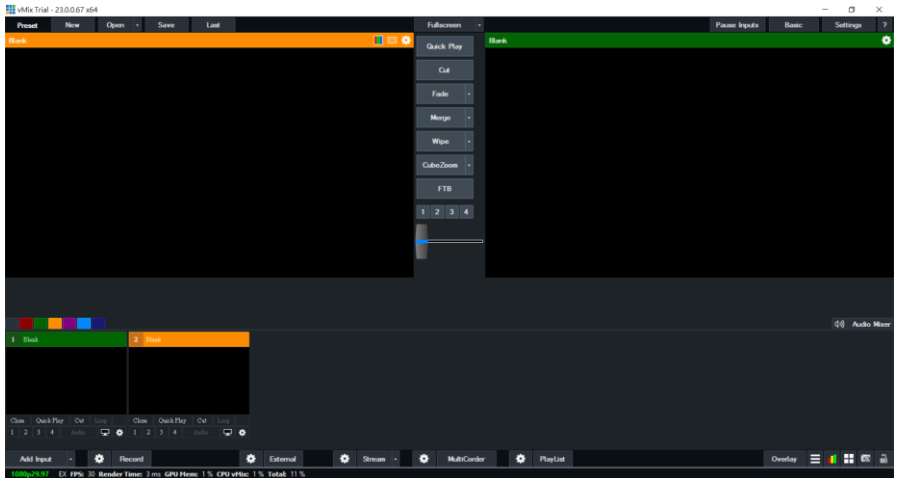

Click “Add Input” then “More”.

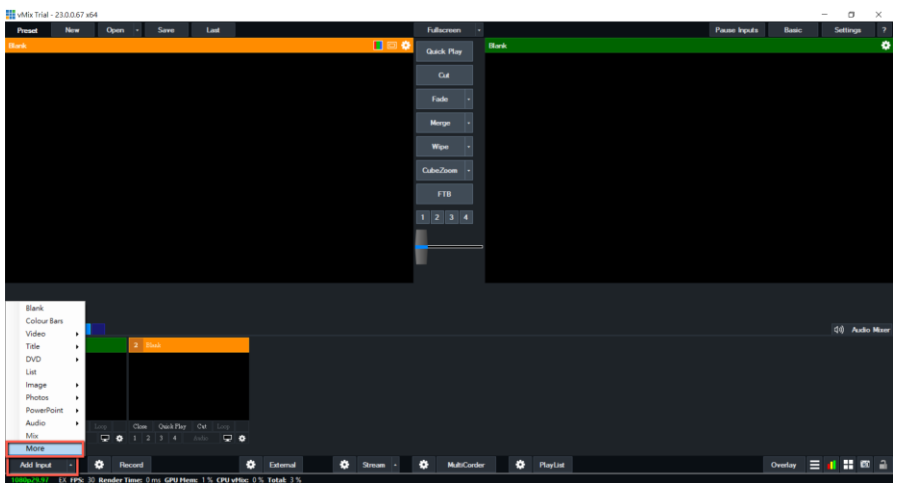

On the Input Select window, click “Stream/SRT” then select “SRT Listener” from the “Stream Type” drop-down menu. After that, enter the following into the respective fields.

- Port: 5000
- Passphrase: 8888888888 (Password for Stream Encryption)
- Key length: 32 (The same length as the key length set previously on the PTC-140’s Web UI)

Click the “OK” button.

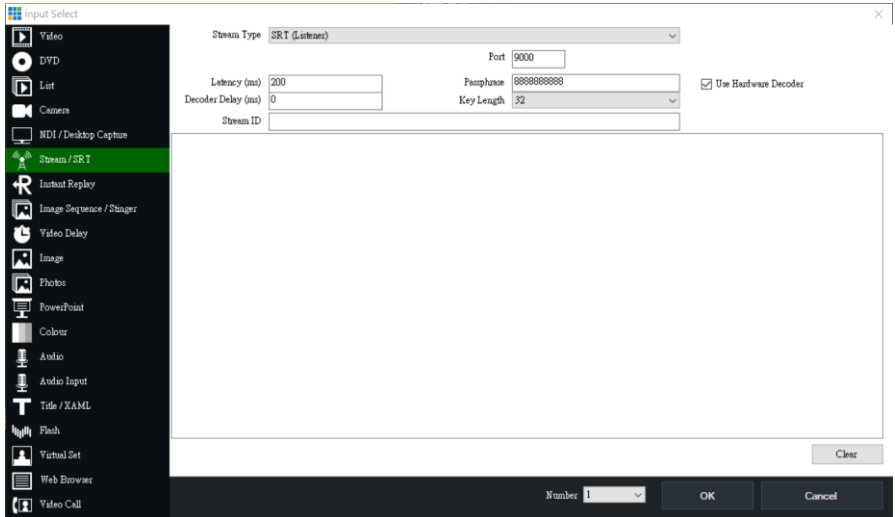

The PTC-140 camera video is now successfully streamed to the vMix via SRT.

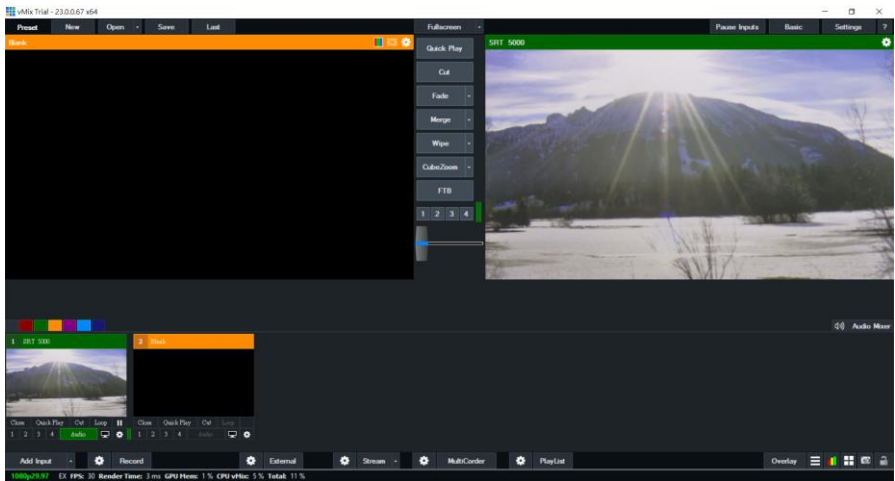

RTP Multicast

The RTP Multicast allows you to view camera video on certain video players such as VLC media player from a remote location.

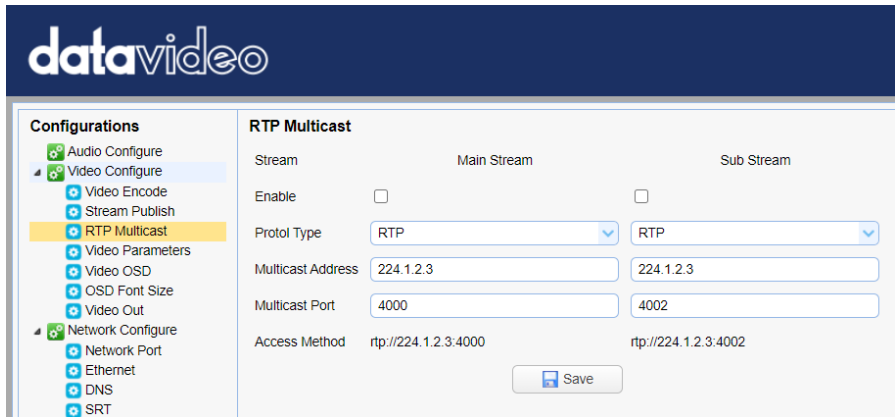

Follow the steps outlined below to view the camera video on VLC media player.

1. Download VLC media player from the link <https://www.videolan.org>.
2. Open VLC, click “Media” → “Open Network Stream” then enter `rtp://224.1.2.3:4000` to view the main stream and `rtp://224.1.2.3:4002` to view the sub stream.

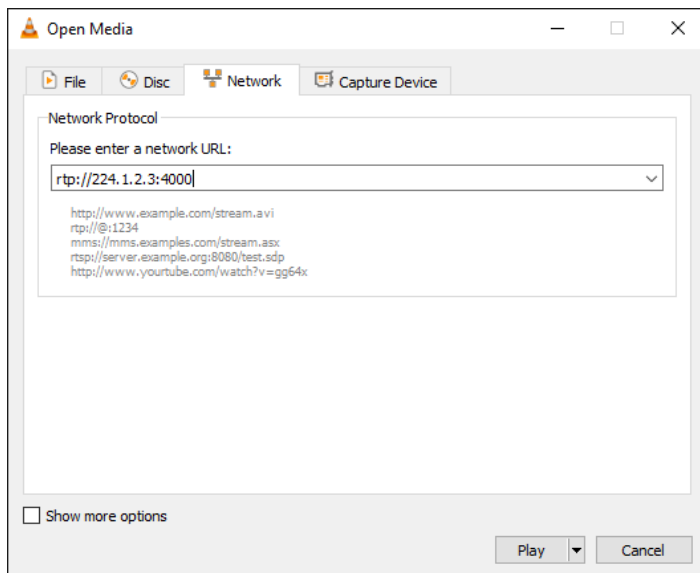

3. Click the **“Play”** button to start viewing the video stream.

You can also choose to stream over TS protocol. Follow the steps outlined below to view the camera video on VLC media player over TS protocol.

1. On **RTP Multicast** page of the PTC-140’s web interface, select **“TS”** from the Protocol Type drop-down menu.

Stream	Main Stream	Sub Stream
Enable	<input type="checkbox"/>	<input type="checkbox"/>
Protol Type	TS	RTP
Multicast Address	224.1.2.3	224.1.2.3
Multicast Port	4000	4002
Access Method	udp://@224.1.2.3:4000	rtp://224.1.2.3:4002

Save

2. Open VLC media player, click **“Media”** → **“Open Network Stream”** then enter `udp://@224.1.2.3:4000` to view the main stream and `udp://@224.1.2.3:4002` to view the sub stream.
3. Click the **“Play”** button to start viewing the video stream.

Video Parameters

This sets the camera focus, exposure, color balance, image settings, noise reduction and picture styles.

Focus

In **Focus**, you are allowed to set **Focus Mode**, **Auto Focus Zone** and **Auto Focus Sensitivity**.

Configurations

- Audio Configure
- Video Configure
 - Video Encode
 - Stream Publish
 - RTP Multicast
 - Video Parameters
 - Video OSD
 - OSD Font Size
 - Video Out
- Network Configure
 - Network Port
 - Ethernet
 - DNS
 - SRT
- System Configure
 - SystAttr
 - SysTime
 - SysUser
 - Update
 - Default
 - Reboot

Video Param



Focus
Exposure
Color
Image
NR
Style
Refresh

Focus Mode

AF-Zone

AF-Sensitivity

*Click the "Refresh" button to refresh parameter.

*Effective after changed parameters

- Focus Mode: Available modes are **Auto**, **Manual** and **One Push**.
- AF-Zone: This sets auto focus zone by selecting **Top**, **Center**, **Bottom** or **All** from the drop-down menu.
- AF-Sensitivity: This sets auto focus sensitivity by selecting High, Middle and Low from the drop-down menu.

Exposure

In **Exposure**, you are allowed to set Exposure Mode, Exposure Value (EV), Backlight Compensation (BLC), Anti-Flicker, Gain Limit and Dynamic Range Compression (DRC).

Configurations

- Audio Configure
- Video Configure
 - Video Encode
 - Stream Publish
 - RTP Multicast
 - Video Parameters
 - Video OSD
 - OSD Font Size
 - Video Out
- Network Configure
 - Network Port
 - Ethernet
 - DNS
 - SRT
- System Configure
 - SystAttr
 - SysTime
 - SysUser
 - Update
 - Default
 - Reboot

Video Param

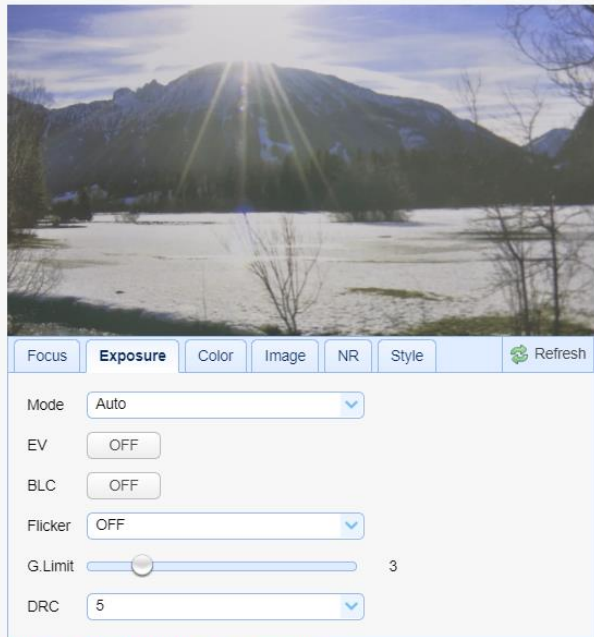

*Click the "Refresh" button to refresh parameter.

*Effective after changed parameters

- Mode: Available focus modes are **Auto**, **Manual**, **SAE (Shutter Automatic Exposure)**, **AAE (Aperture Automatic Exposure)** and **Bright**.

Auto – Fully automatic settings for shutter speed and aperture with the ability to adjust gain, dynamic range, backlight and anti-flicker.

Manual – Full iris, shutter speed and range control

Shutter Automatic Exposure – The camera will measure light and automatically set the aperture based on the desired shutter speed.

Aperture Automatic Exposure – The camera will measure light and automatically set the shutter speed based on the desired iris opening (aperture).

- EV: **EV** is exposure value. By turning it ON, an EV slider will appear for adjusting the exposure value.

- BLC: By turning the **backlight compensation**, the camera will compensate for backlight by enhancing automatic exposure control on the camera.
- Flicker: To avoid video flicker, you can set your camera flicker frequency to **50Hz** or **60Hz**.
- Gain Limit Slider: Select gain limit from 0 to 15.
- DRC: Sets the amount of Dynamic Range Compression where higher values lead to more compression (**1 – 8** or **off**).

Color

In **Color**, you are allowed to set color balance such as white balance, red gain fine tuning, blue gain fine tuning, saturation, hue and automatic white balance sensitivity. The color balance of your image will change the colors rendered in your image.

The screenshot displays the 'datavideo' web interface. On the left is a 'Configurations' sidebar with a tree view containing categories like Video Configure, Network Configure, and System Configure. The 'Video Param' section is active, showing a live video feed of a snowy mountain landscape. Below the video are tabs for Focus, Exposure, Color, Image, NR, Style, and a Refresh button. The 'Color' tab is selected, showing settings for WB Mode (Auto), RG Tuning (0), BG Tuning (0), Saturation (100%), Hue (7), and AWB Sensitivity (High). Red text at the bottom of the interface reads: '*Click the "Refresh" button to refresh parameter.' and '*Effective after changed parameters'.

- WB Mode: Select white balance mode from the options listed below.
 - Auto
 - Manual
 - One Push
 - VAR (2400K – 7100K with a step size of 100)
- RG Tuning: This fine tunes the red gain from **-10 to 10** but effective only in **AUTO** mode.
- BG Tuning: This fine tunes the blue gain from **-10 to 10** but effective only in **AUTO** mode.
- Saturation: **60% to 200%**.
Note: The higher the saturation, the more vivid the colors will be.
- Hue: Chroma adjustment from **0 to 14**.
- AWB Sensitivity: This is the white balance sensitivity; select **Low, Middle** or **High**.

Image

Other image settings include brightness, contrast, sharpness, gamma, digital cinema, black and white, orientation and digital zoom.

Configurations

- Audio Configure
- Video Configure
 - Video Encode
 - Stream Publish
 - RTP Multicast
 - Video Parameters
 - Video OSD
 - OSD Font Size
 - Video Out
- Network Configure
 - Network Port
 - Ethernet
 - DNS
 - SRT
- System Configure
 - SystAttr
 - SysTime
 - SysUser
 - Update
 - Default
 - Reboot

Video Param



Focus
Exposure
Color
Image
NR
Style
 Refresh

Bright	<input type="range" value="7"/>	7
Contrast	<input type="range" value="8"/>	8
Sharpness	<input type="range" value="5"/>	5
Gamma	<input type="text" value="0.45"/>	
DCI	<input type="text" value="OFF"/>	
B&W Mode	<input type="button" value="Color"/>	
Flip-H	<input type="button" value="OFF"/>	
Flip-V	<input type="button" value="OFF"/>	
DZoom	<input type="button" value="OFF"/>	
Low-Light Mode	<input type="button" value="OFF"/>	

*Click the "Refresh" button to refresh parameter.

*Effective after changed parameters

- Bright: Brightness level adjustment from **0 to 14**.
- Contrast: Contrast adjustment from **0 to 14**.
- Sharpness: Sharpness adjustment from **0 to 15**.
- Gamma: Select a gamma value from the list below:
 - Default
 - 0.45
 - 0.50
 - 0.55
 - 0.63

- DCI: To enable DCI, simply select a value from **1 to 8**; selecting **OFF** will disable DCI.
- B&W Mode: This allows you to switch between color and black-and-white modes.
- Flip-H: Turning it ON flips the image along the y-axis.
- Flip-V: Turning in ON flips the image along the x-axis.
- DZoom: This enables/disables digital zoom.
- Low-Light Mode: This enables/disables Low-Light Mode.

NR

Image noise is extremely distracting to viewers and enabling noise reduction will remove noise to achieve a broadcast quality image.

datavideo

Configurations

- Audio Configure
- Video Configure
 - Video Encode
 - Stream Publish
 - RTP Multicast
 - Video Parameters**
 - Video OSD
 - OSD Font Size
 - Video Out
- Network Configure
 - Network Port
 - Ethernet
 - DNS
 - SRT
- System Configure
 - SystAttr
 - SysTime
 - SysUser
 - Update
 - Default
 - Reboot

Video Param

Focus | Exposure | Color | Image | **NR** | Style | Refresh

NR-2D: 1

NR-3D: 5

Dynamic Hot Pixel: OFF

*Click the "Refresh" button to refresh parameter.
*Effective after changed parameters

- NR-2D: 2D noise reduction is ideal for scenes with movement.
 - OFF
 - 1 – 7
 - Auto
- NR-3D: 3D noise reduction is ideal for static fields of view.
 - OFF
 - 1 – 7

Note: By using both 2D and 3D noise reduction together, you can effectively enhance both moving and static imagery, which is ideal for most live broadcast environments.

- Dynamic Hot Pixel: Hot pixels are bright colored spots in your images, often noticeable with slow shutter speeds or high ISO settings. By enabling the dynamic hot pixel feature, these spots will be automatically removed.
 - OFF
 - 1 – 5

Style

In **Style**, you will be able to select the picture style of your preference. The available styles are:

- Default
- Normal
- Clarity
- Bright
- Soft

Configurations

- Audio Configure
- Video Configure
 - Video Encode
 - Stream Publish
 - RTP Multicast
 - Video Parameters**
 - Video OSD
 - OSD Font Size
 - Video Out
- Network Configure
 - Network Port
 - Ethernet
 - DNS
 - SRT
- System Configure
 - SysAttr
 - SysTime
 - SysUser
 - Update
 - Default
 - Reboot

Video Param



Focus Exposure Color Image NR **Style** Refresh

Style: Bright

**Click the "Refresh" button to refresh parameter.*
**Effective after changed parameters*

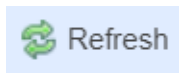

Note: Each time after you modify the camera parameters, please click the Refresh button to apply the new settings.

Video OSD

In **Video OSD**, you will be allowed to show video time and title on the screen. You can further set the font color as well as their positions.

Configurations

- Audio Configure
- Video Configure
 - Video Encode
 - Stream Publish
 - RTP Multicast
 - Video Parameters
 - Video OSD
 - OSD Font Size
 - Video Out
- Network Configure
 - Network Port
 - Ethernet
 - DNS
 - SRT
- System Configure
 - SystAttr
 - SysTime
 - SysUser
 - Update
 - Default
 - Reboot

Video OSD



Show Time

Show Title

Time Font Color

Title Font Color

OSD Offset Title Time

Enable Video Time and Title on Screen

Show Time

Show Title

Simply check the checkbox then click the **Save** button to display video time and title on the screen.

Set Font Color of Time and Title

You can also select a display color for your time and title. Available color options include:

- White
- Black
- Yellow
- Red
- Blue

Adjust Time and Title Positions



On the OSD Offset tile, you will be allowed to adjust positions of the Time and Title displayed on the screen. First select Time or Title then click the arrow buttons to move it to the desired position.

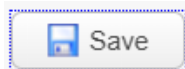

Note: After you've configured the video time and title, click the Save button to apply the new settings.

OSD Font Size

In **OSD Font Size**, you can set the font size for the Master and Slave streams by entering a number into the respective textboxes shown in the diagram below. In addition, you can also select to allow the system to scale the font size automatically according to the resolution set.

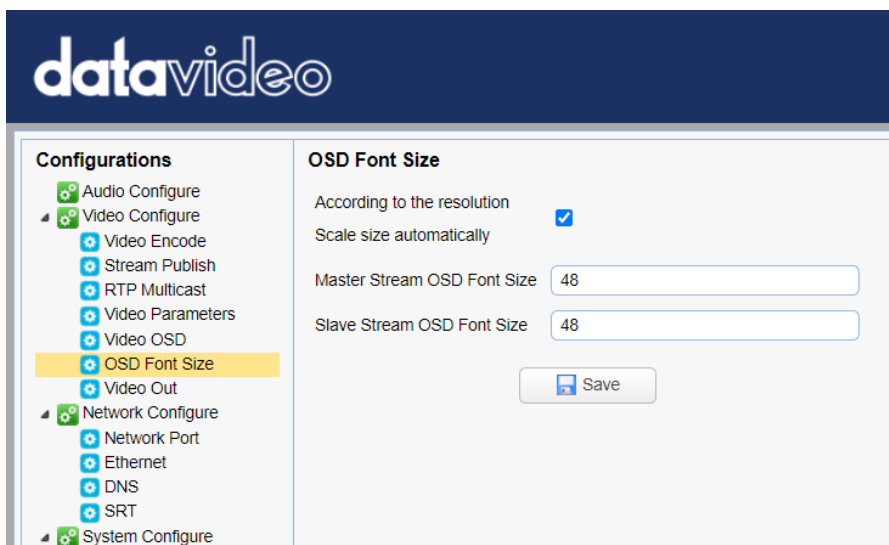

Video OUT

The **Video Out** allows users to select the desired video output resolution from the drop-down menu. Supported output resolutions include:

- 1080P60
- 1080P50

- 1080P30
- 1080P25
- 1080I60
- 1080I50
- 720P60
- 720P50
- 1080P59.94
- 1080I59.94
- 720P59.94
- 1080P29.97

Note: Click the Save button after you've selected a resolution.

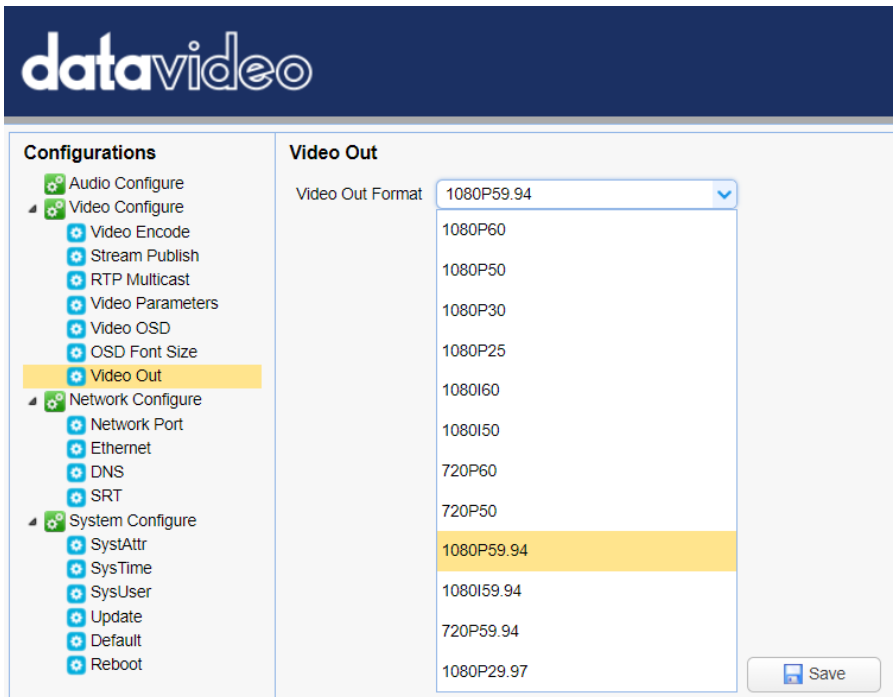

Network Configure

Network Configure allows you to configure the network functions of your camera.

Network Port

In **Network Port**, you should be able to find a list of default port numbers for different data communication protocols. Please note that these port numbers may vary according to your network environment.

Note: Click the Save button after you've edited the port numbers.

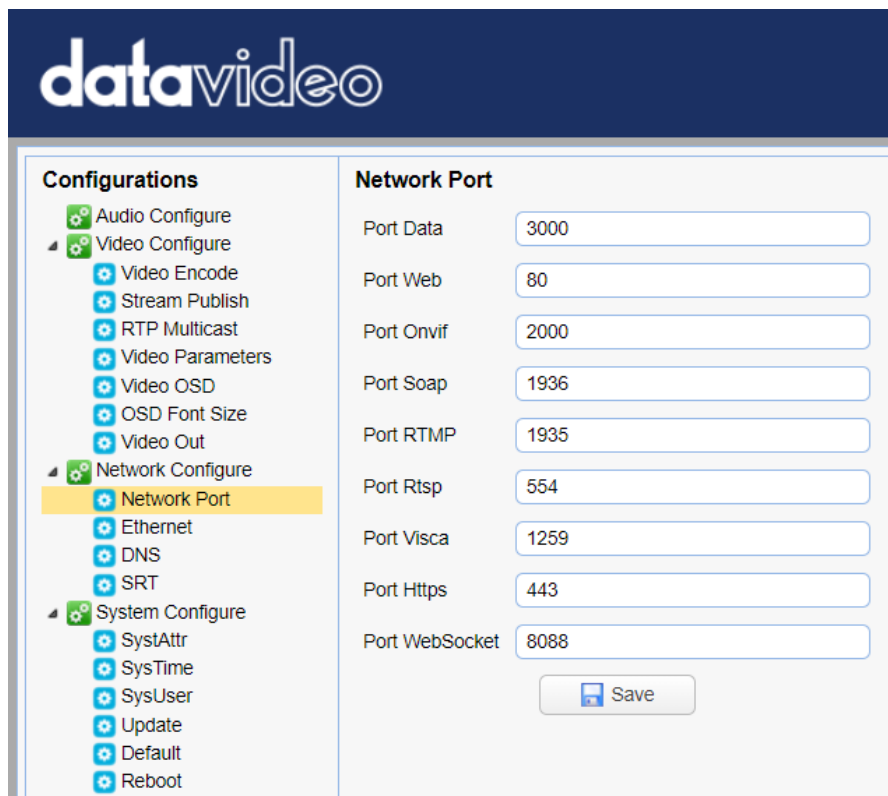

The screenshot shows the DataVideo configuration interface. On the left, a sidebar lists various configuration categories: Audio Configure, Video Configure (expanded), Network Configure (expanded), and System Configure (expanded). Under Network Configure, 'Network Port' is selected and highlighted in yellow. The main area displays the 'Network Port' settings, which include a list of ports and their corresponding values in input fields: Port Data (3000), Port Web (80), Port Onvif (2000), Port Soap (1936), Port RTMP (1935), Port Rtsp (554), Port Visca (1259), Port Https (443), and Port WebSocket (8088). A 'Save' button is located at the bottom right of the settings area.

Port Name	Value
Port Data	3000
Port Web	80
Port Onvif	2000
Port Soap	1936
Port RTMP	1935
Port Rtsp	554
Port Visca	1259
Port Https	443
Port WebSocket	8088

Ethernet

In **Ethernet**, you are allowed to modify your network settings according to your network environment. For more details about **DHCP** and **Static IP Mode**, see **Network Connection**.

Note: Click the Save button after you've edited the network settings.

Configurations

- Audio Configure
- Video Configure
 - Video Encode
 - Stream Publish
 - RTP Multicast
 - Video Parameters
 - Video OSD
 - OSD Font Size
 - Video Out
- Network Configure
 - Network Port
 - Ethernet**
 - DNS
 - SRT
- System Configure
 - SysAttr
 - SysTime
 - SysUser
 - Update
 - Default
 - Reboot

Ethernet

DHCP

IP Address

Subnet Mask

Default Gateway

MAC Address

DNS

In **DNS**, Enter the DNS information which is 8.8.8.8 by default.

Note: Click the **Save** button after you've edited the DNS information.

Configurations

- Audio Configure
- Video Configure
 - Video Encode
 - Stream Publish
 - RTP Multicast
 - Video Parameters
 - Video OSD
 - OSD Font Size
 - Video Out
- Network Configure
 - Network Port
 - Ethernet
 - DNS**
 - SRT
- System Configure

DNS

Preferred DNS Server

Alternative DNS Server

SRT

In SRT, you can set the port number for the SRT stream. The default port number is 9000. The password and the key length allow you to encrypt the SRT stream.

Note: Click the **Save** button after you've edited the SRT settings.

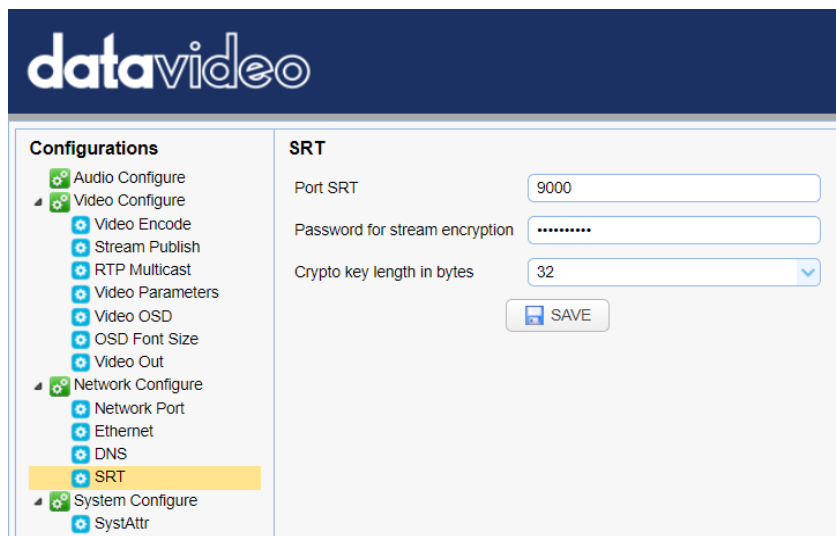

System Configure

System Configure allows you to configure your camera system.

System Attribute

In System Attribute, you are allowed to edit your camera name and select the Web UI language. Available languages are **Traditional Chinese**, **Simplified Chinese** and **English**.

The screenshot shows the DataVideo configuration interface. On the left, under 'Configurations', there is a tree view with categories: Audio Configure, Video Configure (expanded), Network Configure (expanded), and System Configure (expanded). Under 'System Configure', 'SystAttr' is highlighted in yellow. On the right, the 'System Attribute' section contains three input fields: 'Device Name' with the value 'PTC-140', 'Device ID' with the value '1', and 'Language' with a dropdown menu set to 'English'. A 'Save' button is located below these fields.

System Time

In **System Time**, you are allowed to set the **Date Format, Time Zone, Hour Type** and **NTP**.

NTP stands for Network Time Protocol and it is an Internet protocol used to synchronize the clocks of devices over a network to some time reference. Once NTP is enabled, you will be allowed to select the update frequency and assign the time server.

If NTP is not enabled, you may choose to synchronize the device time with the computer time.

Configurations

- Audio Configure
- Video Configure
 - Video Encode
 - Stream Publish
 - RTP Multicast
 - Video Parameters
 - Video OSD
 - OSD Font Size
 - Video Out
- Network Configure
 - Network Port
 - Ethernet
 - DNS
 - SRT
- System Configure
 - SystAttr
 - SysTime**
 - SysUser
 - Update
 - Default
 - Reboot

System Time

Date Format: YYYY-MM-DD

Date Sprtr: /

Zone: (GMT+08:00)Beijing, Hongkong, Sin

Hour Type: 24 Hours

NTP Enable:

Update Interval: 1 day

Host Uri: time.nist.gov

Host Port: 123

Time Settings

Time Settings: Synchronize with computer time

Computer Time: 2021-01-22 10:21:23

System User

In **System User**, you are allowed to edit the login credentials for Admin, User 1 and User 2.

Note: Click the **Save** button to save the new login credentials.

Configurations

- Audio Configure
- Video Configure
 - Video Encode
 - Stream Publish
 - RTP Multicast
 - Video Parameters
 - Video OSD
 - OSD Font Size
 - Video Out
- Network Configure
 - Network Port
 - Ethernet
 - DNS
 - SRT
- System Configure
 - SystAttr
 - SysTime
 - SysUser**

User Set

Authority: admin

User Name: admin

Password:

Confirm Password:

Update

This is where you will be able to view current firmware information. See **Firmware Update** for detailed firmware upgrade instructions.

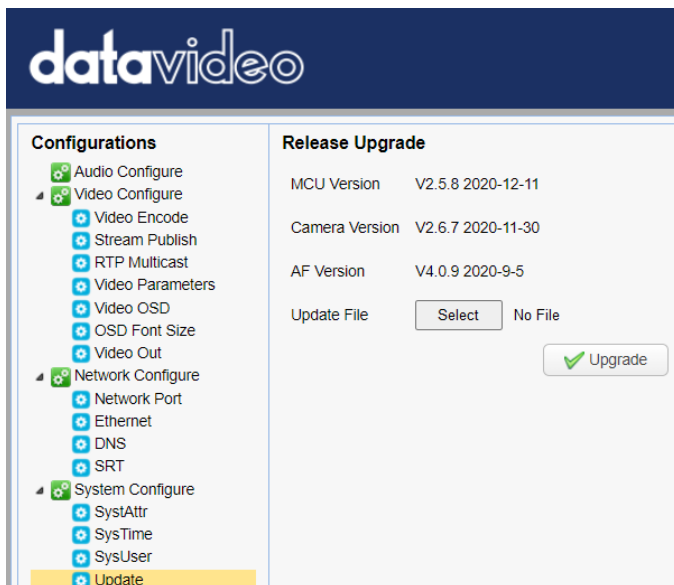

The screenshot shows the DataVideo web interface. The top header is dark blue with the 'datavideo' logo in white. Below the header, there are two main sections: 'Configurations' on the left and 'Release Upgrade' on the right. The 'Configurations' section is a tree view with the following items: Audio Configure, Video Configure (expanded), Video Encode, Stream Publish, RTP Multicast, Video Parameters, Video OSD, OSD Font Size, Video Out, Network Configure (expanded), Network Port, Ethernet, DNS, SRT, System Configure (expanded), SystAttr, SysTime, SysUser, and Update (highlighted in yellow). The 'Release Upgrade' section displays the following information: MCU Version V2.5.8 2020-12-11, Camera Version V2.6.7 2020-11-30, AF Version V4.0.9 2020-9-5, and Update File. There is a 'Select' button next to 'Update File' and a 'No File' button. Below these is a green 'Upgrade' button with a checkmark icon.

Default

In **Default**, click “Restore factory defaults” to reset the device to factory defaults.

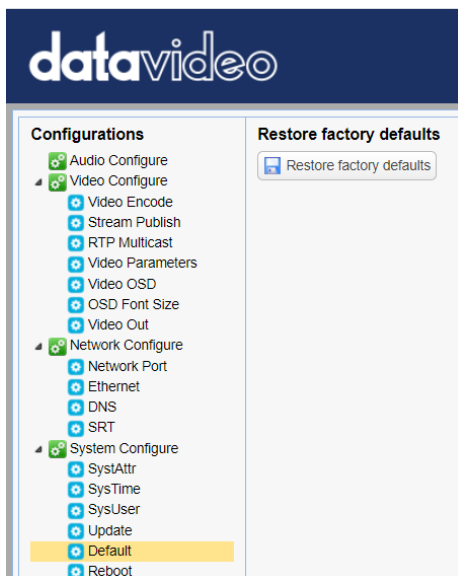

The screenshot shows the DataVideo web interface. The top header is dark blue with the 'datavideo' logo in white. Below the header, there are two main sections: 'Configurations' on the left and 'Restore factory defaults' on the right. The 'Configurations' section is a tree view with the following items: Audio Configure, Video Configure (expanded), Video Encode, Stream Publish, RTP Multicast, Video Parameters, Video OSD, OSD Font Size, Video Out, Network Configure (expanded), Network Port, Ethernet, DNS, SRT, System Configure (expanded), SystAttr, SysTime, SysUser, Update, Default (highlighted in yellow), and Reboot. The 'Restore factory defaults' section contains a single button labeled 'Restore factory defaults' with a factory icon.

Reboot

Click “**Reboot**” to reboot the device.

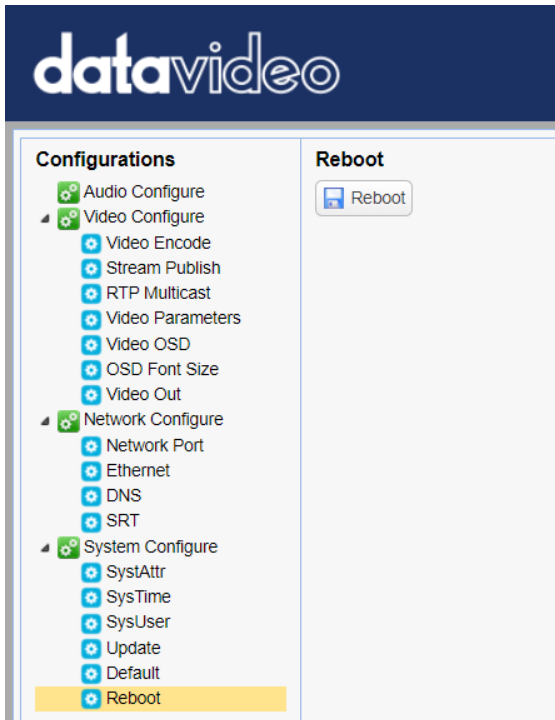

The screenshot displays the DataVideo web interface. At the top, the "datavideo" logo is visible in white on a dark blue background. Below the logo, the interface is divided into two main sections: "Configurations" on the left and "Reboot" on the right. The "Configurations" section contains a tree view of settings categories, each with a gear icon and a right-pointing arrow. The categories are: "Audio Configure", "Video Configure", "Network Configure", and "System Configure". Under "Video Configure", there are sub-items: "Video Encode", "Stream Publish", "RTP Multicast", "Video Parameters", "Video OSD", "OSD Font Size", and "Video Out". Under "Network Configure", there are sub-items: "Network Port", "Ethernet", "DNS", and "SRT". Under "System Configure", there are sub-items: "SystAttr", "SysTime", "SysUser", "Update", "Default", and "Reboot". The "Reboot" option is highlighted with a yellow background. The "Reboot" section on the right contains a single button with a power icon and the text "Reboot".

9. Remote Control Port Pinouts

In addition to using the Ethernet port for remote control, you can also connect your PC or any keyboard controllers to the RS-232 or RS-422/RS-485 remote port to control PTC-140. Use an Ethernet cable to connect the external RS-232 or RS-422/RS-485 controller to PTC-140. You can make your own cable using the pinout information provided in this chapter.

Remote Control Port

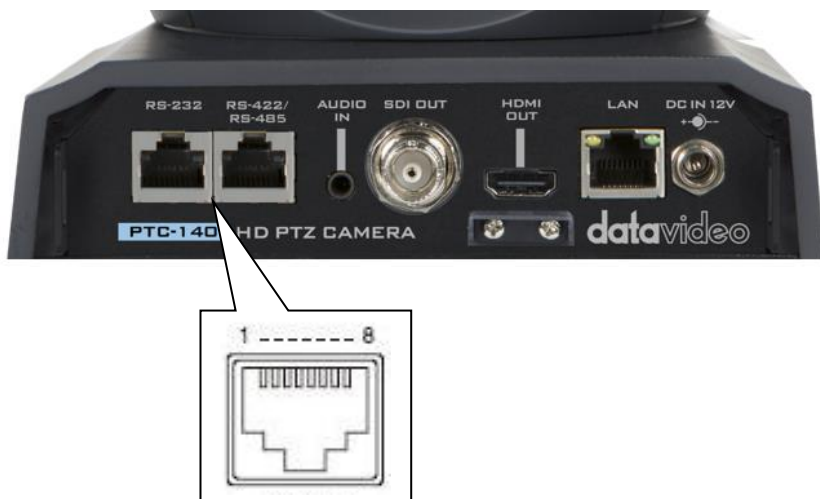

The RS-232 pinout is described below.

No.	RJ-45 Connector	Camera's RS-232 Port
1	White/Orange	GND
2	Orange	NC
3	White/Green	NC
4	Blue	Transmit IN
5	White/Blue	NC
6	Green	Receive IN
7	White/Brown	Transmit OUT
8	Brown	Receive OUT

The RS-422/RS-485 4-wire pinout is described below.

No.	RJ-45 Connector	Camera's RS-422/485 Port
1	White/Orange	GND
2	Orange	NC
3	White/Green	RX-
4	Blue	TX-
5	White/Blue	TX+
6	Green	RX+
7	White/Brown	NC
8	Brown	NC

The RS-485 2-wire pinout is described below.

No.	RJ-45 Connector	Camera's RS-485 Port
1	White/Orange	GND
2	Orange	NC
3	White/Green	(RX-/TX-)
4	Blue	NC
5	White/Blue	NC
6	Green	(RX+/TX+)
7	White/Brown	NC
8	Brown	NC

10. Firmware Update

Datavideo usually releases new firmware containing new features or reported bug fixes from time to time. Customers can either download the firmware as they wish or contact their local dealer or reseller for assistance.

This section outlines the firmware upgrade process which should take **approximately few minutes to complete**.

The existing settings should persist through the firmware upgrade process, which should not be interrupted once started as this could result in a non-responsive unit.

Requirements

- PTC-140 Unit
- PC/Laptop
- Latest firmware files
Download from <https://www.datavideo.com/product/PTC-140>
- Ethernet Cable
- Router if connected over a network

Procedure

1. Open the web user interface of the PTC-140.
2. Click “System Configure” → “Update”

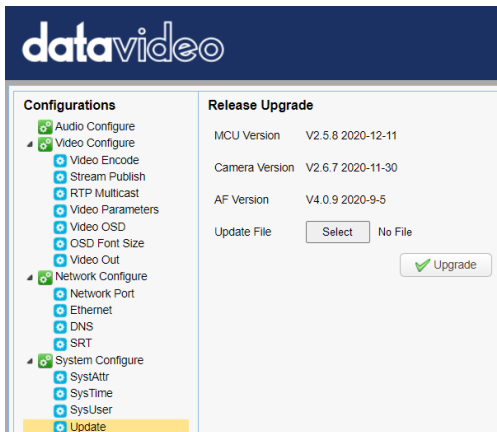

3. Click “Select File” button to browse your disk for the latest firmware file.
4. Click “Upgrade” button to start upgrading the firmware.

11. Frequently-Asked Questions

This section describes problems that you may encounter while using PTC-140. If you have any questions, please refer to related sections and follow all suggested solutions. If problem still exists, please contact your distributor or the service center.

No.	Problems	Solutions
1.	What are important points of product maintenance?	<ol style="list-style-type: none">1. If the camera will not be used for a long time, please unplug the 12V DC power plug, and remove AC power adapter from AC outlet.2. Use soft cloth or tissue to clean the camera.3. After washing the camera lens, dry it with a soft dry cloth. Use a neutral detergent rather than acidic or corrosive detergents to clean the lens.
2.	There is no output video.	<ol style="list-style-type: none">1. Check that your power is properly connected. This is indicated by the power LED.2. Make sure the camera is switched ON.3. Check your video cable connection.
3.	I have seen image jitter while zooming in or out.	<ol style="list-style-type: none">1. Make sure the camera is properly mounted.2. Make sure that machines that could cause vibration are not in proximity of the camera.
4.	The remote control is not working.	<ol style="list-style-type: none">1. Try setting the camera to CAM1 and try again.2. Make sure the remote control's battery is fully charged.3. Check your device working mode.4. Make sure the OSD menu is turned off. The remote control cannot be used if the OSD menu is enabled.
5.	The serial port is not working properly.	<ol style="list-style-type: none">1. Make sure you are using the standard connection cable provided by Datavideo.2. Make sure your baud rate and device addresses are correct.3. Check your cable connection.

		4. Check your device working mode.
6.	I cannot log in to the web user interface.	<ol style="list-style-type: none"> 1. Check your Ethernet connection. 2. Check your network settings such as IP address.
7.	The camera image cannot be viewed in the preview window.	<p>Make sure you are using Google Chrome or Microsoft Edge to view the camera image in the preview window. The preview window cannot open in Microsoft Internet Explorer.</p> <p>The preview window may stop responding if the browser is left idle for a period of time. To resume playing, try refreshing the page or relogin the web UI.</p>

12. Dimensions

Unit: mm

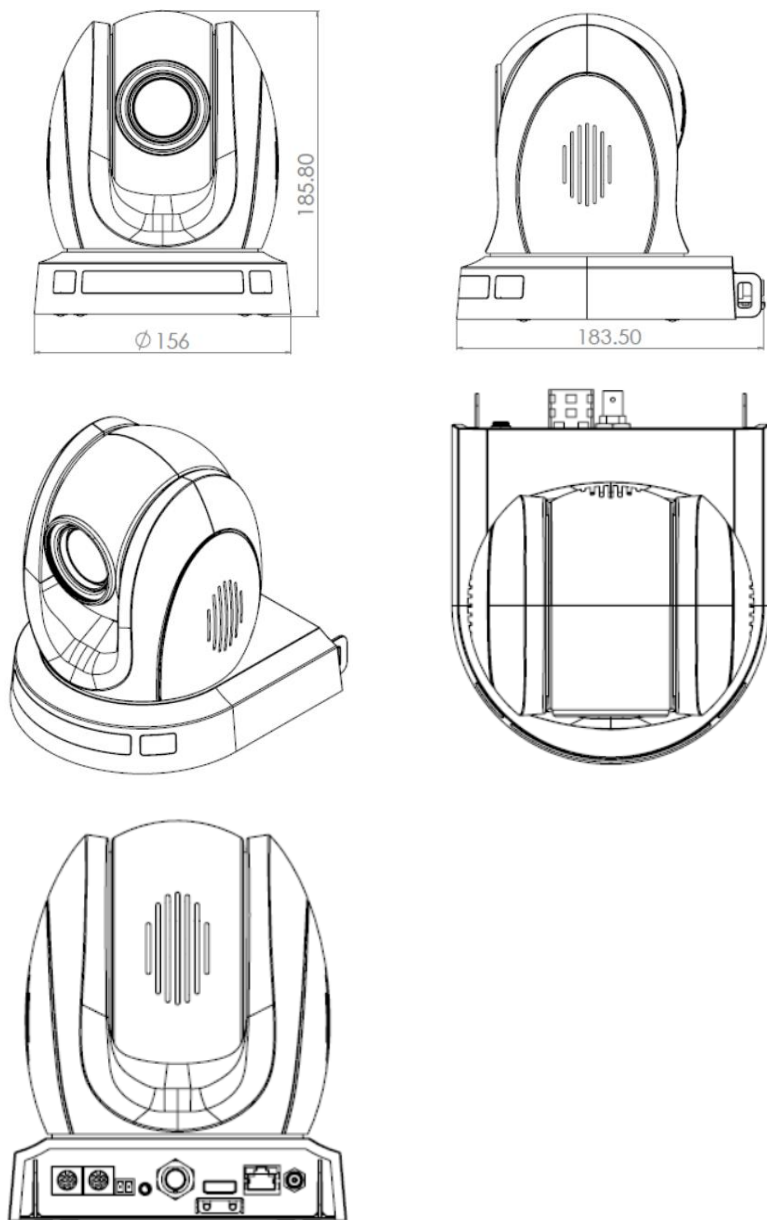

13. Specifications

Camera Parameters	
Video Format	1080p 60/59.94/50/30/29.97/25 1080i 60/59.94/50 720p 60/59.94/50
Image Sensor	1/2.8 inch high quality HD CMOS sensor
Effective Pixels (approx.)	2.07 Mega pixels
S/N Ratio	>55dB
Min. Illumination	0.5Lux (F1.8, AGC ON)
Electronic Shutter	Auto / Manual
Zoom Ratio	20x Optical Zoom, 10x Digital Zoom
Gamma Control	Off / Normal
Iris Control	Auto / Manual
Digital Noise Reductions	Yes
On-Screen Display (OSD)	English, Simplified Chinese
White Balance	Auto, Manual, One Push, 3000K, 4000K, 5000K, 6500K
AGC / Gain Control	Auto / Manual
Mirror / Flip Image	Yes
Focus Mode	Auto / Manual
Panning / Tilting Range	Pan: 340° Tilt: +90° to -30°
Panning / Tilting Speed	Pan: 0.1~60°/sec Tilt: 0.1~30°/sec
Preset	255 Positions
Focal Length	f=5.2 (wide) to 98 (tele) mm F1.6 to F3.5
Field of View (Horizontal, Wide)	Approx. 54.7° (WIDE END) / 3.3° (TELE END)
Image Compensation	Backlight Compensation

Input /Output Interfaces	
Video Output	HDMI x 1 SDI x 1
Audio Input	3.5mm Line in
Tally LED	Dual colors (Red, Green)
Lens Filter	M52.0 x 0.75 Thread with UV Protection
Control Protocol	VISCA/Pelco-D/Pelco-P; Baud Rate:115200/38400/9600/4800/2400bps DVIP
Remote Control Interface and Transmit Distance	RJ-45: for IP control (DVIP) RS-232: Mini DIN 8-pin (IN / OUT) RS-485
Video Compression Format	H.264, H.265, Dual stream output
Audio Compression Format	AAC/MP3/G.711A Audio compression
HD IP Interface	100M IP port(100BASE-TX); Support DVIP
Streaming Protocols	TCP/IP, HTTP, RTSP, RTMP(S), DHCP, Multicast, etc
Others	
F/W Update	Ethernet
IR Control	Yes
Camera Control Unit	RMC-180/RMC-300C
Tripod Mount	1/4-20 UNC
Optional Accessories	WM-1/ WM-10
Color	Dark Blue/White
Dimensions (LxWxH)	156 x 184 x 186 mm
Weight	1.6 kg
Operating Temp. Range	0~40 °C
Power	DC 12V 12W

Notes

Notes

Service & Support

It is our goal to make your products ownership a satisfying experience. Our supporting staff is available to assist you in setting up and operating your system. Please refer to our web site www.datavideo.com for answers to common questions, support requests or contact your local office below.

Please visit our website for latest manual update.

www.datavideo.com/product/PTC-140

datavideo
www.datavideo.com



@DatavideoUSA @DatavideoIndia2016
@DatavideoEMEA @Datavideojapan
@DatavideoTaiwan @DatavideoLatam
@DatavideoAsia @DatavideoBrasil



@Datavideo
@Datavideo_EMEA
@Datavideo_Taiwan



@DatavideoUSA
@DVTWDVCN



@DatavideoUSA
@DatavideoEurope

All the trademarks are the properties of their respective owners.