

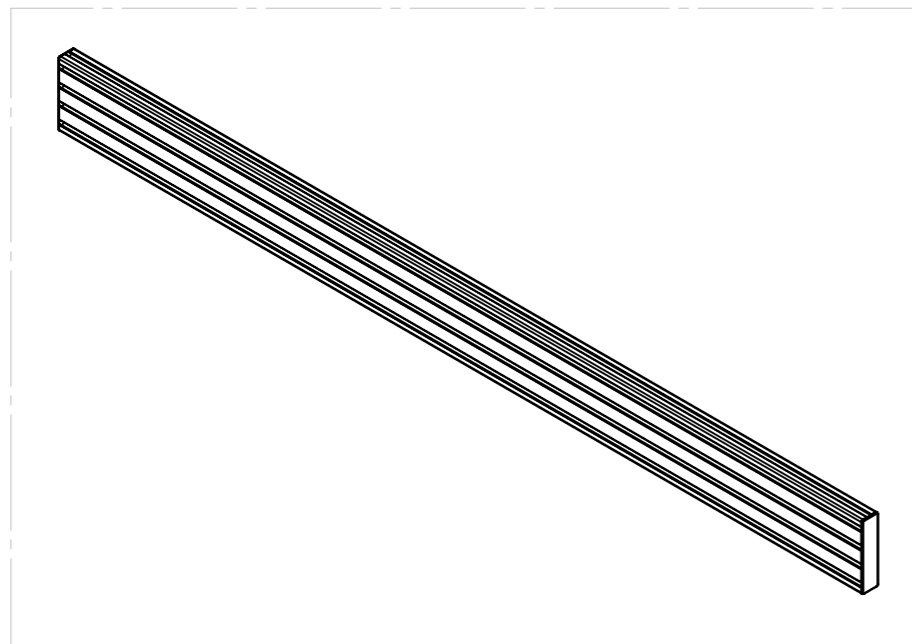

THE INFORMATION CONTAINED IN THIS DRAWING IS THE SOLE PROPERTY OF B-TECH INTERNATIONAL DESIGN AND MANUFACTURING LIMITED, ANY REPRODUCTION IN PART OR WHOLE WITHOUT THE WRITTEN PERMISSION OF B-TECH INTERNATIONAL DESIGN AND MANUFACTURING LIMITED IS PROHIBITED.

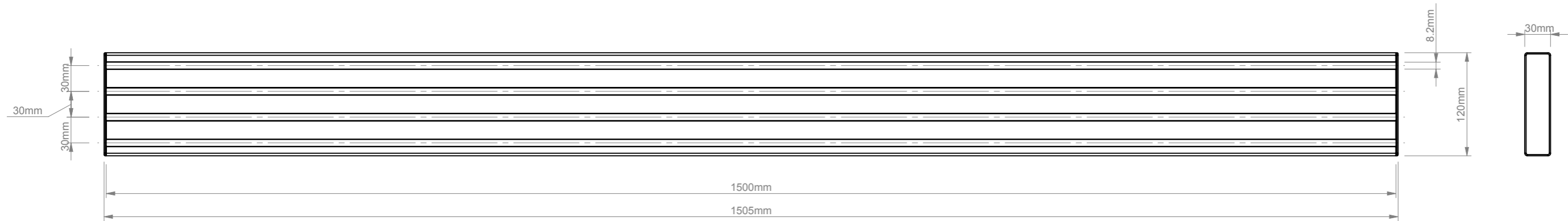
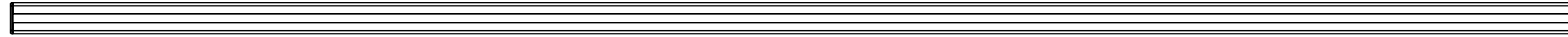

SCALE 1:10

B-Tech International Design and Manufacturing Limited		B-Tech No: BT8390-150
Part of the B-Tech International Group of Companies		Version: V1.0
 UNLESS OTHERWISE SPECIFIED DIMENSIONS ARE IN MILLIMETERS	Size: A3	Title: Horizontal Mounting Bar - 1.5m
	Scale: 1:5	Revision: 0.0
Sheet: 1 of 1	Date: 12/01/2015	File Name: BTD-BT8390-150-R0.0