

# Mi Electric Scooter User Manual

Actual functions may vary due to technical upgrades and firmware updates.  
For latest functions and safety instructions, please go to Mi Community to exchange with other users.  
Online support: [www.mi.com/service](http://www.mi.com/service)



# Thank you for purchasing

Thank you for purchasing Mi Electric Scooter. It is a sports and recreational vehicle with style.

## Contents

1. Package Contents .....	02
2. Product Overview .....	03
3. Assembly and Set-Up .....	04
4. Charge Your Scooter .....	05
5. How To Ride .....	05
6. Safety Instructions .....	07
7. Folding and Carrying .....	12
8. Daily Care and Maintenance .....	13
9. Specifications .....	16
10. Trademark and Legal statement .....	17
11. Certifications .....	18
12. Quick Setup .....	20

# 1 Package Contents

## Assembled Electric Scooter

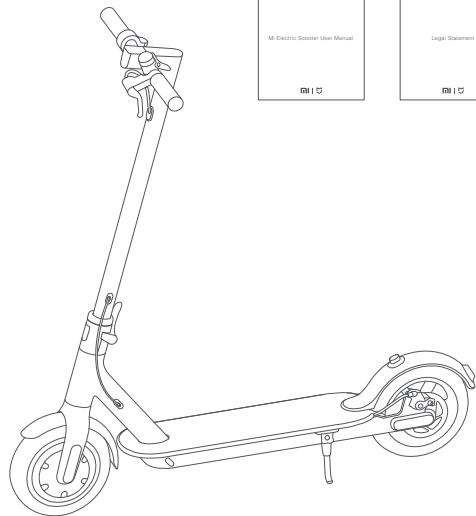

User Manual    Legal Statement    Quick Start Guide    Warranty Card

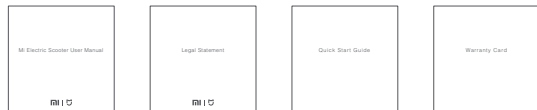

## Accessories

Extended Nozzle Adapter



Screw × 4



Hexagon Wrench



tire × 2



Charging Adapter



Carefully check package contents, if anything is missing or damaged, please contact local customer service for support.

# 2 Product Overview

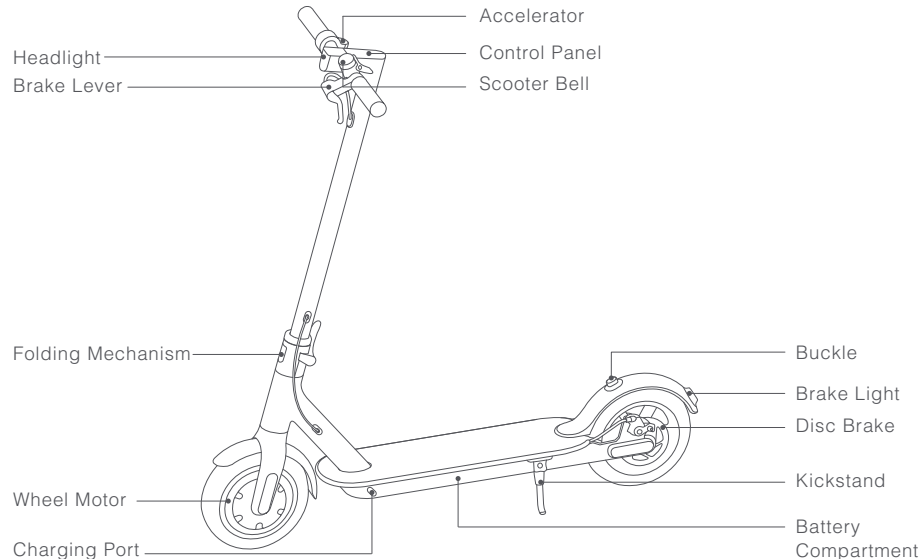

## Control Panel



Battery level display

Mode display

Power button

The power level is indicated by four power lights on the control panel. As power is consumed, the lights will change from solid to flashing, and finally turn off from up to down. When all four power lights are on, the battery level is between 100% - 86%; When three lights are solid and one is flashing, the battery level is between 85% - 71%, and so on. When the bottom power light flashes, it indicates low power. Please recharge soon for further use. After running out of power, all lights will turn off, and the scooter will coast until it comes to a complete stop.

The bottom light either flashes white or green. The white light indicates regular mode, and green light indicates power-saving mode. (power-saving mode: max speed of 11.2 mph with smoother acceleration for beginners)

When the scooter is off, press the button to turn on the scooter; When the scooter is on, press and hold for 2 seconds to turn off the scooter. After turning on, press the button to turn on or off the headlight; And press twice to switch between modes.

### 3 Assembly and Set-Up

1. Fasten the handlebar stem on the headset, and put the kickstand down

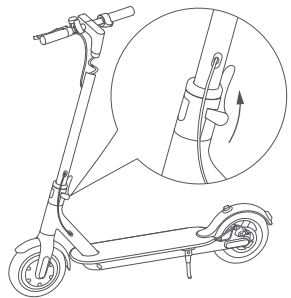

2. Attach the handlebar to the stem

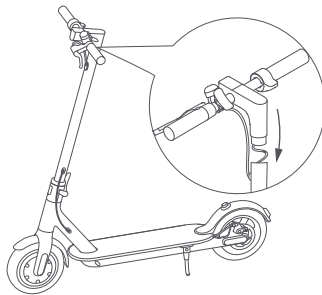

3. Tighten the screws onto both sides of the stem with the hexagon wrench

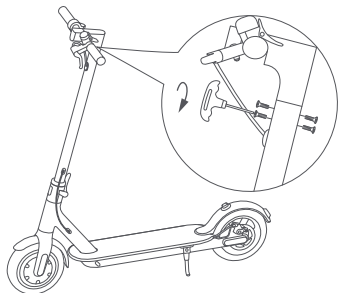

4. After the assembly, press the power button to check if it's working properly

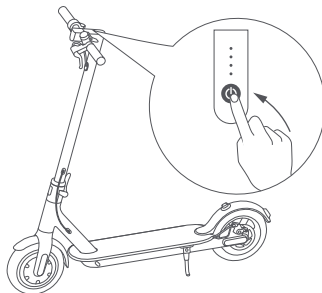

### 4 Charge Your Scooter

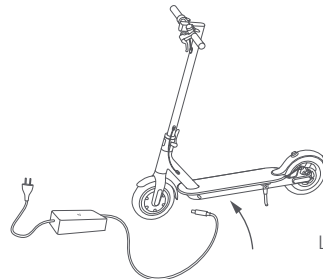

Lift up the rubber flap

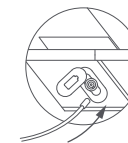

Plug the power adapter into the charging port



When charging is completed, put back the rubber flap

### 5 How To Ride

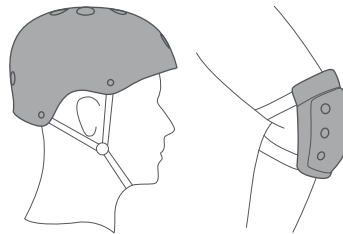

Wear helmets and knee pads in case of falls and injuries when you learn to ride the scooter

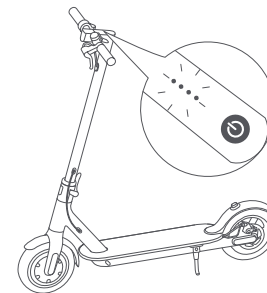

1. Turn on the scooter, and check the power indicator



2. Step on the deck with one foot, and slowly kicks off the other on the ground

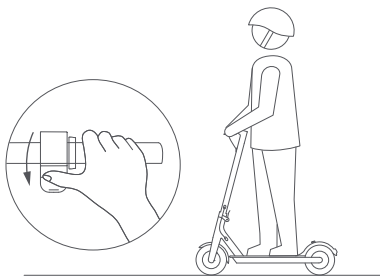

3. When the scooter starts to coast, put both feet on the deck and press the accelerator (the accelerator initiates once the coasting speed exceeds 3.1 mph)

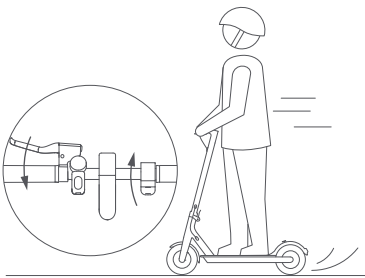

4. Release the accelerator and the kinetic energy recovery system (KERS) initiates automatically to brake slowly; And squeeze the brake lever for a sudden brake

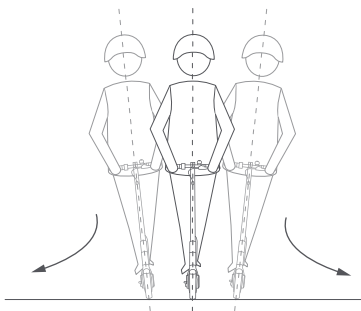

5. Tilt your body to the steering direction as you turn, and slowly turn the handlebar

## 6 Safety Instructions

Watch out for safety risks



 Do not ride in the rain

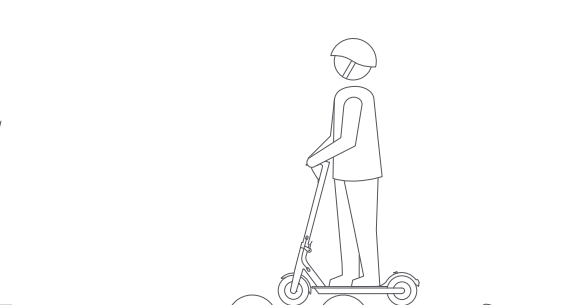

 Keep your speed between 3.1-6.2 mph when you ride through speed bumps, elevator door sills, bumpy roads or other uneven surfaces. Slightly bend your knee to better adjust mentioned surfaces

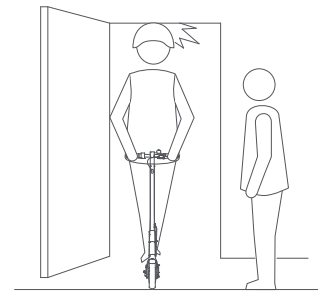

 Look out for doors, elevators and other overhead obstacles

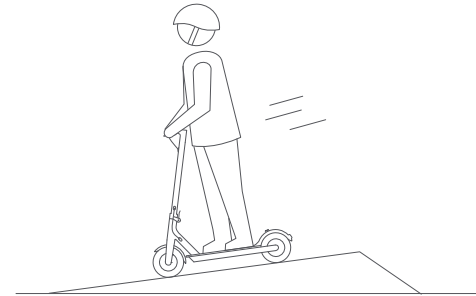

 Do not accelerate when you go downhill

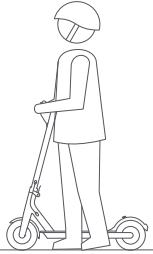
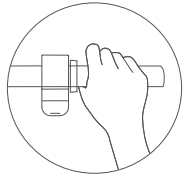

⚠ Do not press the accelerator when you're walking alongside the scooter

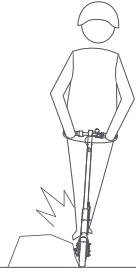

⚠ Always steer clear of obstacles

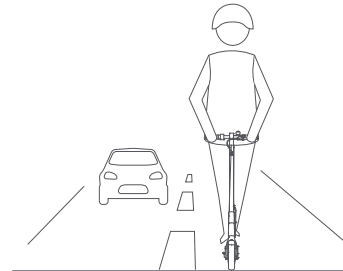

⊗ Do not ride in traffic lanes or residential areas where vehicles and pedestrians are both allowed

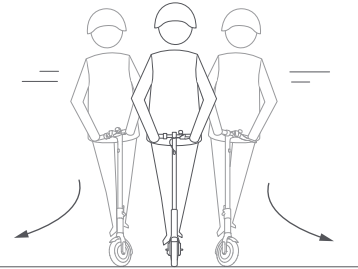

⊗ Do not turn the handlebar violently during high-speed riding

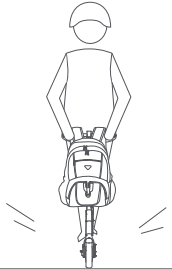

⚠ Do not hang bags or other heavy stuff on the handlebar

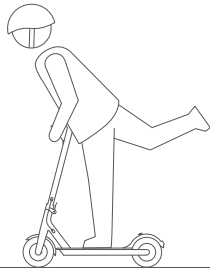

⚠ Keep both feet on the deck all time.



⊗ Do not ride in a ponding that is higher than 0.78 inches

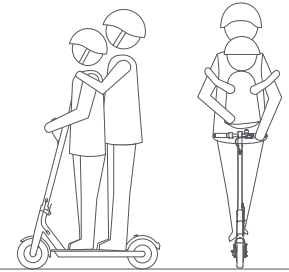

⊗ Do not ride with anyone else, including children

### Do not try following dangerous actions



⊗ Do not keep your feet on the rear mudguard

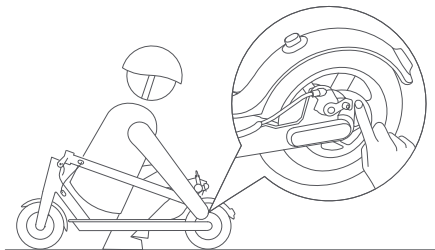

⊗ Do not touch the disc brake



⊗ Do not keep your hands away from handlebar

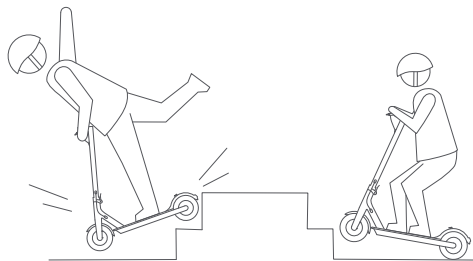

⊗ Do not try riding up or down stairs, and jumping over obstacles

## Safety Reminder

- This electric scooter is a leisure device. But once they're in a public area, they'll be seen as vehicles, subjecting to any risks faced by vehicles. For your safety, please follow instructions in the manual and traffic laws and regulations set forth by government and regulatory agencies. (Pour votre sécurité, veuillez suivre les instructions contenues dans le manuel et les lois sur la circulation et les règlements énoncés par les organismes gouvernementaux et réglementaires.)
- At the same time, you should understand that risks cannot be entirely avoided as others may violate traffic regulations and drive incautiously, and you're exposed to road accidents just as when you're walking or biking. The faster the scooter is, the longer it takes to stop. On a smooth surface, the scooter may slip, lose balance, and even result in a fall. Thus it is crucial that you use caution, keep proper speed and distance, especially so when you're unfamiliar with the place.
- Respect pedestrians' Right of Way. Try not to startle them while driving, especially children. When you ride from behind pedestrians, ring your bell to give them a heads-up and slow your scooter to pass from their left (applicable to countries where vehicles drive on the right). When you ride across pedestrians, keep to the right at a low speed. When you drive across pedestrians, keep the lowest speed or getting off the vehicle.
- Closely follow the safety instructions in the manual especially in China and countries that lack relevant laws and regulations regarding electric scooters. Xiaomi Communication Co., Ltd. shall not be liable for any financial losses, physical injuries, accidents, legal disputes and other interest conflicts resulted from actions that violate user instructions.
- Do not lend your scooter to whoever knows not the operations. And when you do lend it to your friends, please take the responsibility to ensure he/she knows the operation and wears the safety gear.
- Check the scooter before every use. When you note loosen parts, low battery alerts, flat tires, excessive wear, strange sounds, malfunctions and other abnormal conditions, stop riding immediately and call for professional support.

WARNING – Risk of Fire – No User Serviceable Parts.

AVERTISSEMENT - Risque d' incendie -Aucune des pièces ne peut être réparée par l' utilisateur.

## 7 Folding and Carrying

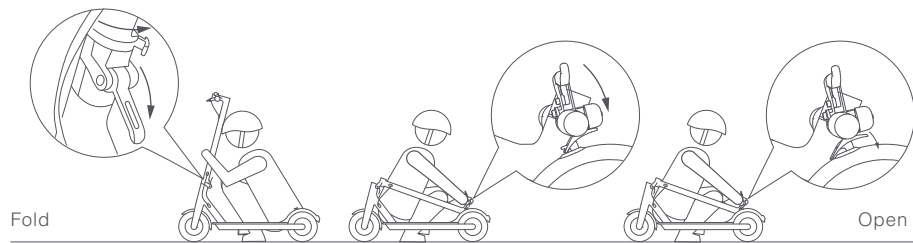

Fold

Open

Make sure that the scooter's turned off. To fold, unlock the folding mechanism, and bend the handlebar stem to hook the buckle on the rear mudguard. To open, press the bell trigger to remove from the buckle, erect the handlebar and lock the folding structure.

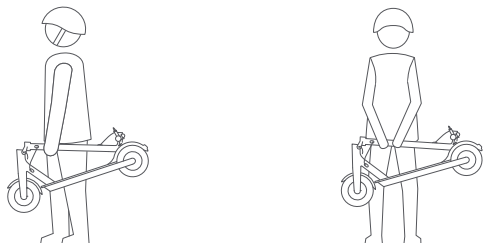

Carry

Hold the handlebar stem with either one hand or both hands to carry.

## 8 Daily Care and Maintenance

### Cleaning and storage

If you see stains on the scooter's body, wipe them off with a damp cloth. If the stains won't scrub off, put on some toothpaste, and brush them with a toothbrush, then wipe them off with a damp cloth. If you see scratches on plastic parts, use sandpaper or other abrasive materials to polish them.

Notes: do not clean the scooter with alcohol, gasoline, kerosene or other corrosive and volatile chemical solvents to prevent dire damage. Do not wash the scooter with a high-pressure water spray. During cleaning, make sure that the scooter's turned off, the charging cable is unplugged, and the rubber flap is closed as water leakage may result in electric shock or other major problems.

When the scooter's not in use, keep it indoors where it is dry and cool. Do not put it outdoors for long time. Excessive sunlight, overheating and overcooling accelerate tire aging and compromise the scooter and the battery pack's lifespan. (Lorsque le scooter n'est pas utilisé, gardez-le à l'intérieur dans un endroit sec et frais. Ne le mettez pas en plein air pendant longtemps. La lumière du soleil excessive, la surchauffe et le sur-refroidissement accélèrent le vieillissement des pneus et compromettent le scooter et la durée de vie de la batterie.)

### Battery maintenance

1. Use original battery packs, use of other models or brands may bring about safety issues;
2. Do not touch the contacts. Do not dismantle or puncture the casing. Keep the contacts away from metal objects to prevent short circuit which may result in battery damage or even injuries and deaths;
3. Use original power adapter to avoid potential damage or fire;
4. Mishandling of used batteries may do tremendous harm to the environment. To protect natural environment, please follow local regulations to properly dispose used batteries.
5. After every use, fully charge the battery to prolong its lifespan.

Do not place the battery in an environment where the ambient temperature is higher than 122°F or lower than -4°F (e.g., do not leave the scooter or the battery pack in a car under direct sunlight for an extended time). Do not throw the battery pack into fire as it may lead to battery failure, battery overheating, and even another fire. If the scooter is expected to be left idle for more than 30 days, please fully charge the battery and place it in a dry and cool place. Keep in mind to recharge it every 60 days to protect the battery from potential damage which is beyond limited warranty.

Always charge before exhausting the battery to prolong the battery's lifespan. The battery pack performs better at normal temperature, and poor when it is below 32°F. For instance, when it is below -4°F, the riding range is only half or less at normal state. When the temperature rises, the riding range restores. For detailed information, please refer to Mi Home App.

Note: fully charged Mi Electric Scooter will last for 120-180 days. The built-in intelligent chip will keep a log of its charging and discharging records. The damage caused by prolonged no charge is irreversible and is beyond limited warranty. Once the damage is done, the battery can not be recharged (non-professionals are forbidden to dismantle the battery pack, as it may cause electric shock, short circuit or even major safety accidents).



## Adjusting the disc brake

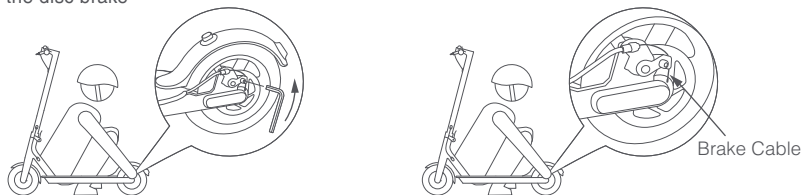

If the brake is too tight, use the M4 hexagon wrench to loosen the screws on the caliper, and slightly send back the brake cable to shorten the exposed length, then tighten the screws. If the brake is too loose, loosen the screws, and slightly pull out the brake cable to lengthen the exposed length, then tighten the screws.

## Adjust the handlebar

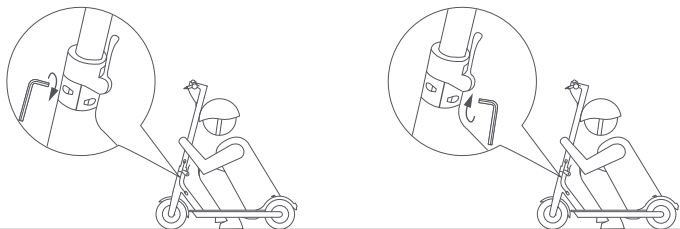

If the handlebar and its stem sway during riding, use the M5 hexagon wrench to tighten the screws on the folding mechanism.

## How to use the extended nozzle adapter

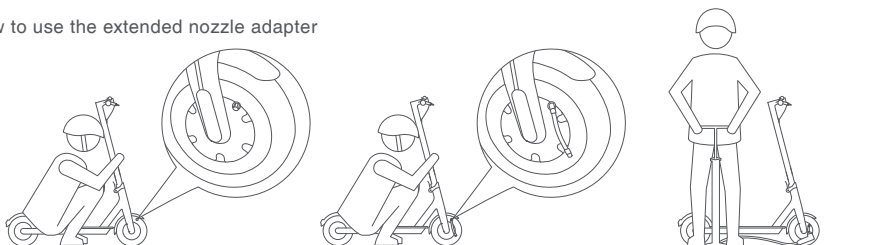

If your tires are flat, remove the screw-on cap from the valve, and connect the extended nozzle adapter to the valve for pumping up.

## Remove the outer and inner tires

**Note:** Crowbars not included, and should be purchased separately.

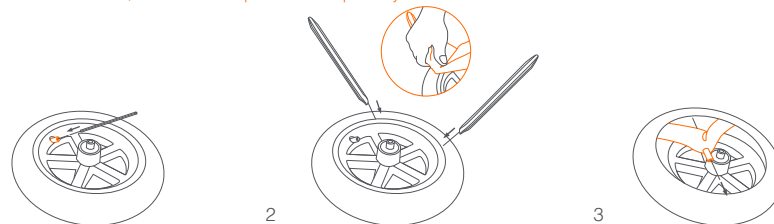

1. Deflate the inner tire first. Use a tool to press the core rod in the air valve so that air is discharged from the inner tire, and use another hand to forcibly pinch the tire at different places to discharge more air.
2. Select a position far from the air valve on the outer tire, use two crowbars to pry up the outer tire by about 1/6 of the circumference, and forcibly separate one side of the outer tire from the hub.
3. Find the air valve, and pull the air valve out of the air valve hole of hub. To pull out the air valve more conveniently, hold the air valve of the inner tire, and pull the outer tire outwards slowly, lest the inner tire would be damaged. Remove the inner tire from the position of air valve in sequence, and separate the inner tire finally.

**Note:** Wrap the pointed end of the crowbar with fiber cloth so that it will not damage the inner tire and coating of the hub.

## Install the inner and outer tires

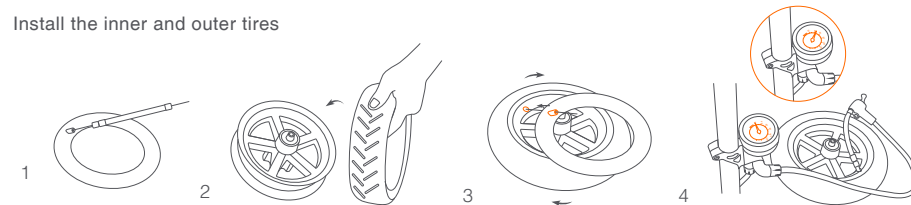

1. Fill a small amount of air into the deflated inner tire till the inner tire is just bulged to look round.
2. Put the hub on the top of a desk. Pay attention to the direction when installing the outer tire. There is an arrow on the outer tire, and it must be consistent with the forward direction of the wheel. Use one hand to hold the hub, and use the other hand to insert one side of the outer tire in the hub groove.
3. Insert the air valve of the inner tire into the air valve hole. Insert the inner tire in the outer tire clockwise and in sequence. Make sure that the air valve does not tilt. Then, insert the other side of the outer tire in the hub groove. Finally use a crowbar to insert one side of the outer tire in the hub groove. After installation, pinch the outer tire to check if the inner tire is pressed by the tire lips of outer tire.
4. Inflate the inner tire to 15-20 PSI, and check the safety lines at two sides of the outer tire. Make sure that the distances from the safety lines to the hub edge are consistent.
5. Finally inflate the inner tire to 45-50 PSI. Tighten the air valve cap. Then, the tire assembly is completed.

**Note:** Wrap the pointed end of the crowbar with fiber cloth so that it will not damage the inner tire and coating of the hub.

## 9 Specifications

Performance index	Items	Specifications
Dimensions	L × W × H [1] (inch)	42.5×16.9×44.9
	After folding: L × W × H (inch)	42.5×16.9×19.3
Weight	Item weight (lb)	Approx. 26.9
Riding requirements	Load range (lb)	55.1-220
	Age	16-50
	Body length (inch)	47.2-78.7
Main parameters	Max. speed (mph)	Approx. 15.5
	General range[2] (miles)	Approx. 18.6
	Max. climbing angle (%)	Approx. 14
	Suitable surfaces	Cement, asphalt and mud roads; bench lower than 1cm; crevice narrower than 1.2 inch
	Operating temperature (°F)	14-104
	Storage temperature (°F)	-4-113
Battery pack	IP rating	IP54
	Rated voltage (VDC)	36
	Max. input voltage (VDC)	42
	Rated capacity (Wh)	280
	Intelligent battery management system	Unusual temperature/short circuit/under voltage/over current/dual overcharge/dual over-discharge protections
Wheel Motor	Rated power (W)	250
	Max. power (W)	500
Charging adapter	Output power (W)	71
	Input voltage (VAC)	100-240
	Output voltage (VDC)	42
	Output current (A)	1.7
	Charging time (h)	Approx. 5

[1] Item height: from the ground to the top of the scooter;

[2] General range: measured when it is no wind and at 77°F, the scooter's fully charged to ride at a even speed of 9.3 mph on a flat surface with a load of 165.3 pounds.

Note: data and specifications may vary due to different models, and are subject to change without notice.

## 10 Trademark and Legal statement

**mi** is a registered trademark owned by Xiaomi Inc (hereinafter referred to as Xiaomi). Xiaomi reserves all rights to the trademark **mi**. Ninebot is a registered trademark of Ninebot(Tianjin) Technology Co., Ltd., all other trademarks and trade names are those of their respective owners.

© 2017 Ninebot (Beijing) Technology Co., Ltd all rights reserved.

This manual included all functions and instructions when it is printed. But actual product may vary due to improved functions and design. Please scan the QR code in the back cover for latest user manual.

Principal: Xiaomi Communications Co., Ltd.

Manufacturer: Ninebot (Changzhou) Tech Co., Ltd.

Address: 16F-17F, Block A, Building 3, No.18, Changwu Mid Rd, Wujin Dist., Changzhou, Jiangsu, China.

# 11 Certifications

## Federal Communications Commission (FCC) Compliance Statement for USA

This device complies with part 15 of the FCC rules. Operation is subject to the following two conditions: (1) This device may not cause harmful interference, and (2) this device must accept any interference received, including interference that may cause undesired operation.

**Note:** This equipment has been tested and found to comply with the limits for a Class B digital device, pursuant to part 15 of the FCC Rules. These limits are designed to provide reasonable protection against harmful interference in a residential installation. This equipment generates, uses and can radiate radio frequency energy and, if not installed and used in accordance with the instructions, may cause harmful interference to radio communications. However, there is no guarantee that interference will not occur in a particular installation. If this equipment does cause harmful interference to radio or television reception, which can be determined by turning the equipment off and on, the user is encouraged to try to correct the interference by one or more of the following measures:

- Reorient or relocate the receiving antenna.
- Increase the separation between the equipment and receiver.
- Connect the equipment into an outlet on a circuit different from that to which the receiver is connected.
- Consult the dealer or an experienced radio/TV technician for help.

This equipment complies with FCC radiation exposure limits set forth for an uncontrolled environment.

## Industry Canada (IC) Compliance Statement for Canada

This device complies with Industry Canada license-exempt RSS standard(s). Operation is subject to the following two conditions: (1) this device may not cause interference, and (2) this device must accept any interference, including interference that may cause undesired operation of the device.

Le présent appareil est conforme aux CNR d'Industrie Canada applicables aux appareils radio exempts de licence. L'exploitation est autorisée aux deux conditions suivantes : (1) l'appareil ne doit pas produire de brouillage, et (2) l'utilisateur de l'appareil doit accepter tout brouillage radioélectrique subi, même si le brouillage est susceptible d'en compromettre le fonctionnement.

CAN ICES-3 (B)/NMB-3(B)

Ninebot is not responsible for any changes or modifications not expressly approved by Ninebot. Such modifications could void the user's authority to operate the equipment.

For model: M365  
FCC ID: 2ALS8-NS9633  
IC : 22636-NS9633

## European Union Compliance Statement Battery recycling information for the European Union



Batteries or packaging for batteries are labeled in accordance with European Directive 2006/66/EC concerning batteries and accumulators and waste batteries and accumulators. The Directive determines the framework for the return and recycling of used batteries and accumulators as applicable throughout the European Union. This label is applied to various batteries to indicate that the battery is not to be thrown away, but rather reclaimed upon end of life per this Directive.

In accordance with the European Directive 2006/66/EC, batteries and accumulators are labeled to indicate that they are to be collected separately and recycled at end of life. The label on the battery may also include a chemical symbol for the metal concerned in the battery (Pb for lead, Hg for mercury, and Cd for cadmium). Users of batteries and accumulators must not dispose of batteries and accumulators as unsorted municipal waste, but use the collection framework available to customers for the return, recycling, and treatment of batteries and accumulators. Customer participation is important to minimize any potential effects of batteries and accumulators on the environment and human health due to the potential presence of hazardous substances.

## Restriction of Hazardous Substances Directive (RoHS)

Ninebot (Changzhou) Tech Co., Ltd. products sold in the European Union, on or after 3 January 2013 meet the requirements of Directive 2011/65/EU on the restriction of the use of certain hazardous substances in electrical and electronic equipment ( "RoHS recast" or "RoHS 2" ).

## Radio and Telecommunications Terminal Equipment Directive



Hereby, Ninebot (Changzhou) Tech Co., Ltd. declares that the wireless equipment listed in this section are in compliance with the essential requirements and other relevant provisions of Directive 2014/53/EU.

## 12 Quick Setup

Control your Mi Electric Scooter and interacts it with other smart home devices in Mi Home App.

### 1. Download Mi Home App

Scan the QR code below or go to App Store to download Mi Home App



### 2. Add a device

Open "My devices", select "+" on the upper right to add a device