

# Dell Silent Keyboard and Mouse KM555

## User's Guide

## Notes, cautions, and warnings

 **NOTE:** A NOTE indicates important information that helps you make better use of your product.

 **CAUTION:** A CAUTION indicates either potential damage to hardware or loss of data and tells you how to avoid the problem.

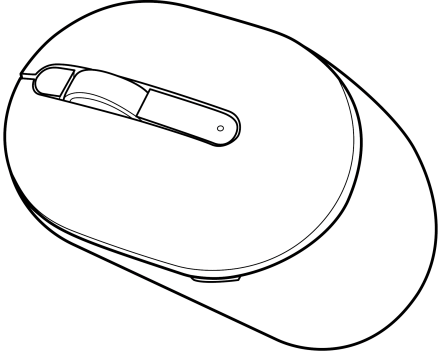
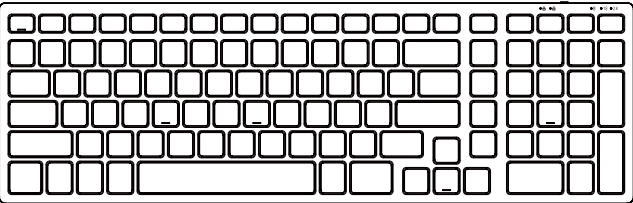
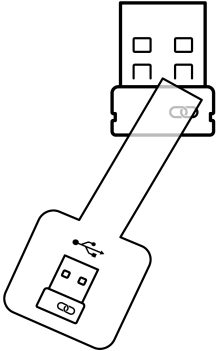
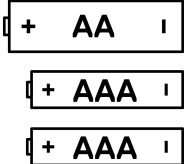
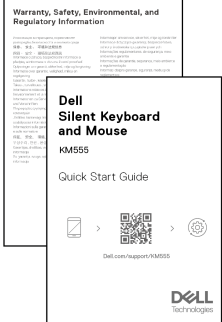
 **WARNING:** A WARNING indicates a potential for property damage, personal injury, or death.

# Contents

<b>What's in the box</b> .....	<b>4</b>
<b>Features</b> .....	<b>5</b>
<b>Wireless mouse</b> .....	<b>5</b>
<b>Wireless keyboard</b> .....	<b>6</b>
<b>Dell Peripheral Manager</b> .....	<b>7</b>
<b>Setting up your wireless mouse</b> .....	<b>7</b>
<b>Pairing your wireless mouse</b> .....	<b>9</b>
<b>Pairing your wireless mouse using the Dell Secure Link USB Receiver</b> .....	<b>9</b>
<b>Pairing your wireless mouse using Bluetooth</b> .....	<b>10</b>
Pairing your wireless mouse using Dell Pair .....	11
Pairing your wireless mouse using Swift Pair .....	11
Add device.....	12
<b>Setting up your wireless keyboard</b> .....	<b>13</b>
<b>Pairing your wireless keyboard</b> .....	<b>14</b>
<b>Pairing your wireless keyboard using the Dell Secure Link USB Receiver</b> .....	<b>14</b>
<b>Pairing your wireless keyboard using Bluetooth</b> .....	<b>16</b>
Pairing your wireless keyboard using Dell Pair.....	17
Pairing your keyboard using Swift Pair.....	17
Add device.....	18
<b>Specifications</b> .....	<b>19</b>
<b>Troubleshooting</b> .....	<b>21</b>
<b>Statutory Information</b> .....	<b>24</b>
<b>Warranty</b> .....	<b>24</b>
Limited warranty and return policies .....	24
For U.S. customers: .....	24
For European, Middle Eastern and African customers:.....	24
For non-U.S. customers:.....	24

# What's in the box

**Table 1.** Package components and descriptions.

Component image	Component description
	Dell Silent Mouse
	Dell Silent Keyboard
	Dell Secure Link USB Receiver
	Battery (AA-type x1 and AAA-type x2)
	Documents

# Features

## Wireless mouse

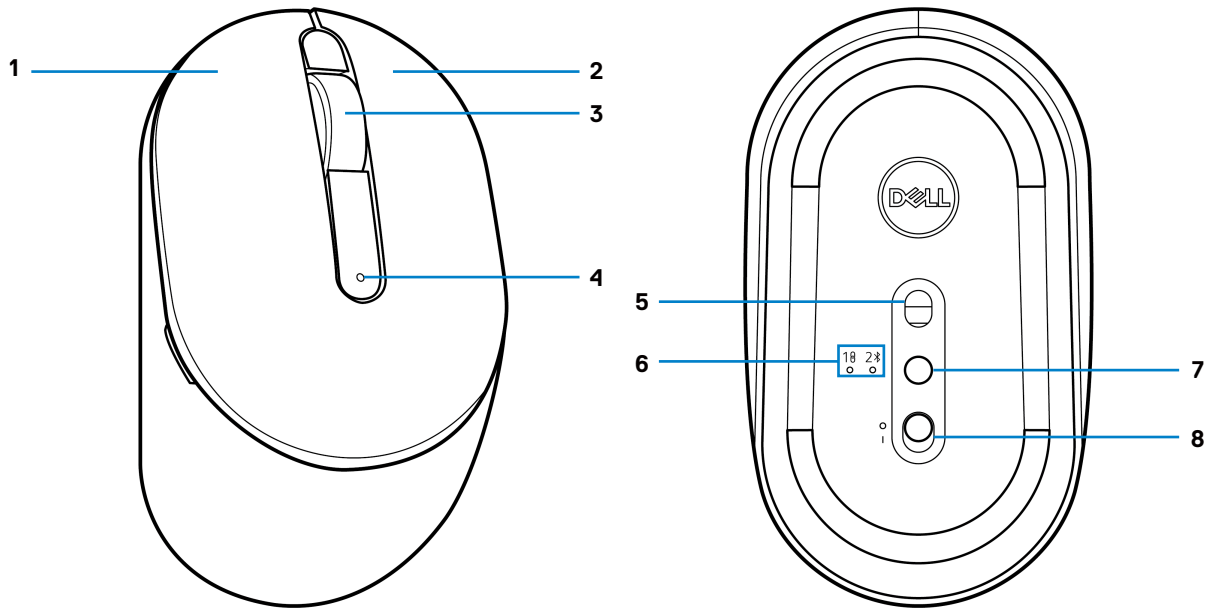
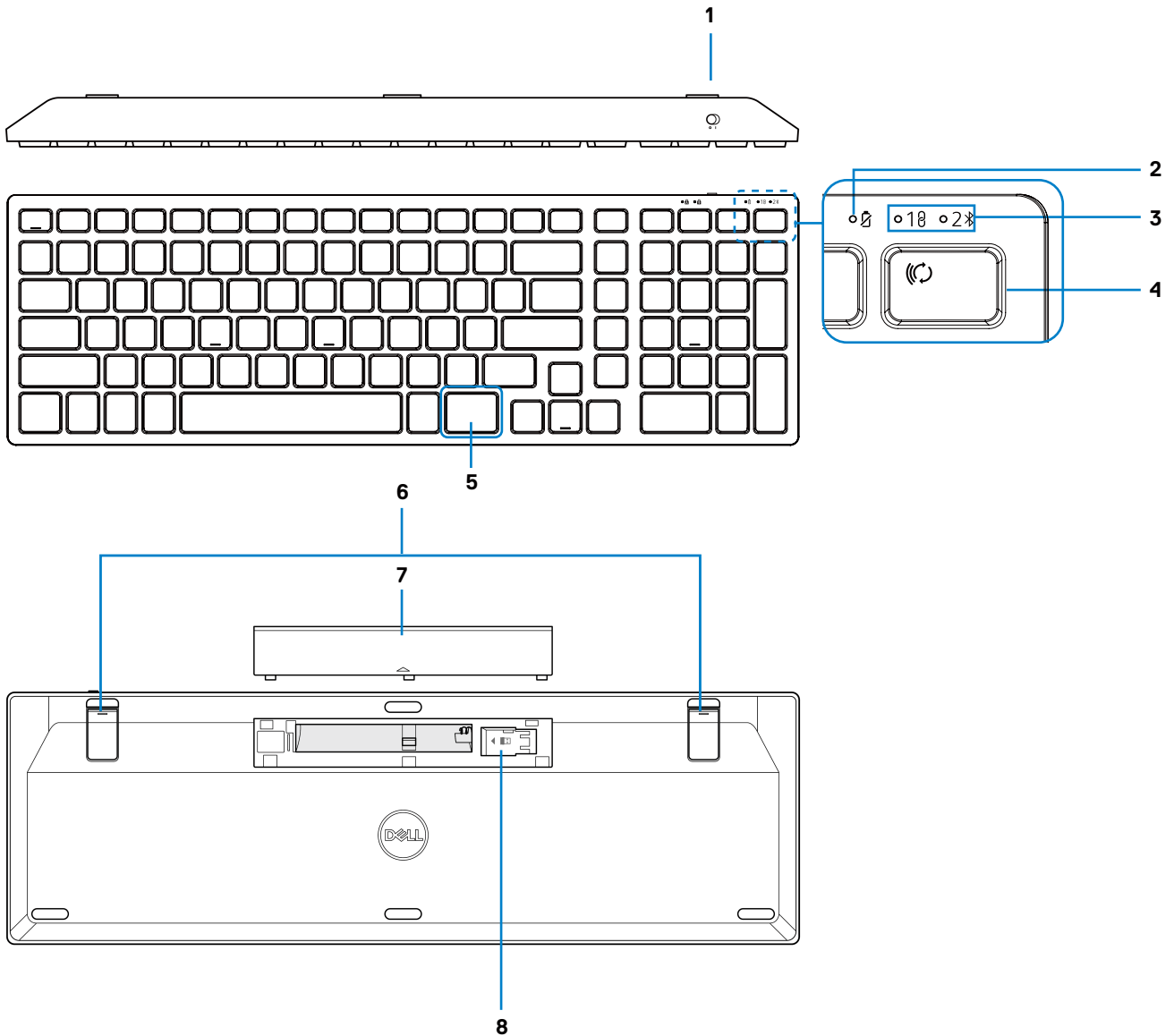


Figure 1. Mouse features

Table 2. Mouse features.

Label	Description
1	Left button
2	Right button
3	Middle button and scroll wheel
4	Low battery LED indicator
5	Optical sensor
6	Connection-mode LED indicators
7	Connection-mode button
8	Power switch

## Wireless keyboard



**Figure 2.** Keyboard features

**Table 3.** Keyboard features.

Label	Description
1	Power switch
2	Low battery LED indicator
3	Connection-mode LED indicators
4	Connection-mode key
5	Copilot key
6	Adjustable tilt legs
7	Battery cover
8	Dongle storage

**NOTE:** The Num Lock and Caps Lock LEDs remain on for 5 seconds after pressing the respective key. They then turn off, even if you continue typing in their current state. The LEDs light up again upon pressing the keys. The lock state is reflected in the On-Screen Display (OSD) on computers with Dell Peripheral Manager.

### Launch Copilot in Windows

**NOTE:** Use  key with supported Windows 11 devices; feature availability varies by device and market, see [aka.ms/KeySupport](https://aka.ms/KeySupport)

**NOTE:** Copilot in Windows is available only in approved markets.

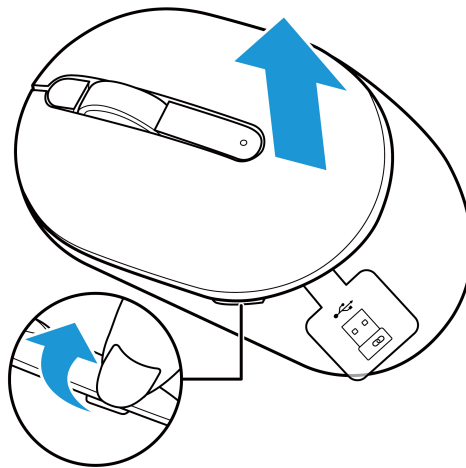
# Dell Peripheral Manager

Dell Peripheral Manager software enables you to perform the following:

- Assign program shortcuts to device programmable buttons or keys through the Action tab.
    - Set primary mouse button (left or right) (for mouse only).
    - Adjust mouse sensitivity through DPI setting (for mouse only).
    - Adjust polling rate (for mouse only).
  - View device information such as firmware version and battery status through the Info tab.
  - Upgrade the latest firmware updates on your devices.
  - Pair additional devices through the Dell Secure Link USB Receiver or directly to your computer through Bluetooth.
- For more information, see Dell Peripheral Manager User's Guide on the product page at [www.dell.com/support](http://www.dell.com/support).

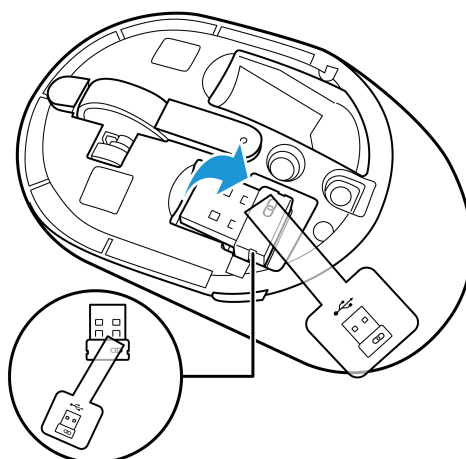
## Setting up your wireless mouse

1. Locate the slot on the side of the mouse cover. Using your fingertip, lift the mouse cover.



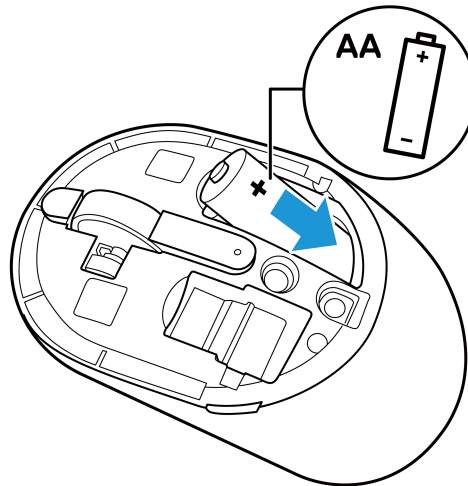
**Figure 3.** Removing the mouse cover

2. Remove the Dell Secure Link USB Receiver from its compartment.



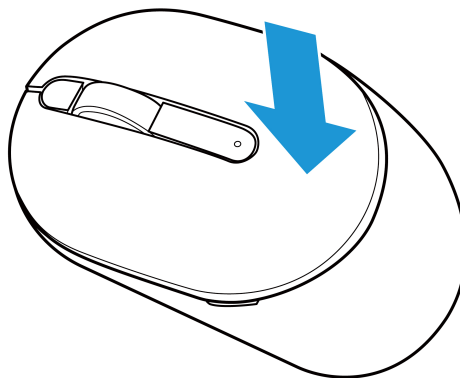
**Figure 4.** Removing the Dell Secure Link USB Receiver

3. Install the AA battery into the battery compartment.



**Figure 5.** Installing the battery

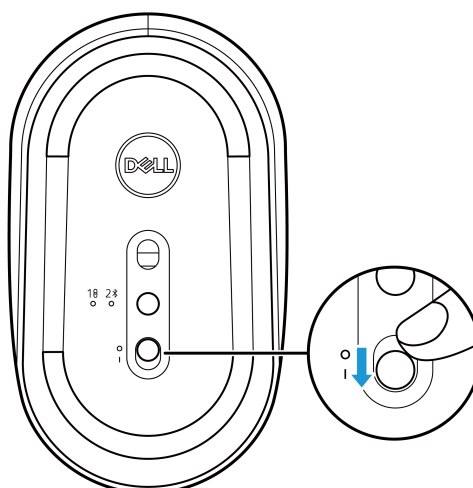
4. Replace the mouse cover.



**Figure 6.** Replacing the mouse cover

5. Slide the power switch to turn on the mouse.

**NOTE:** Ensure that the distance between your computer and mouse is within ten meters.



**Figure 7.** Turning on the mouse

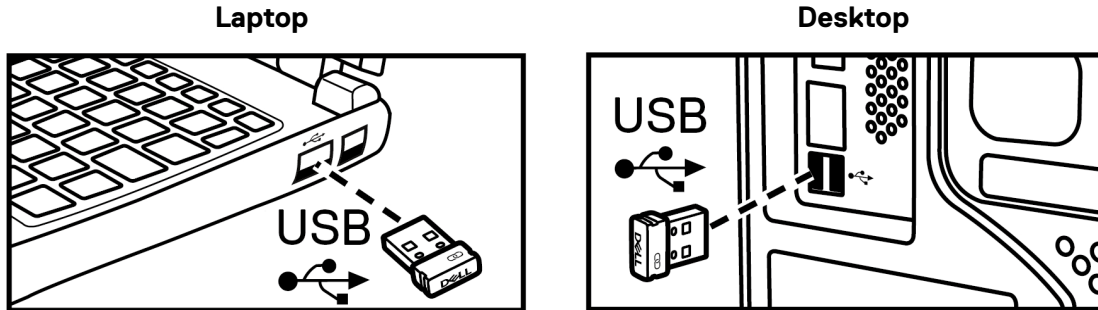


# Pairing your wireless mouse

Your Dell wireless mouse can be paired with devices using either the Dell Secure Link USB Receiver or Bluetooth. You can pair and switch between a laptop, desktop, or any compatible mobile device.

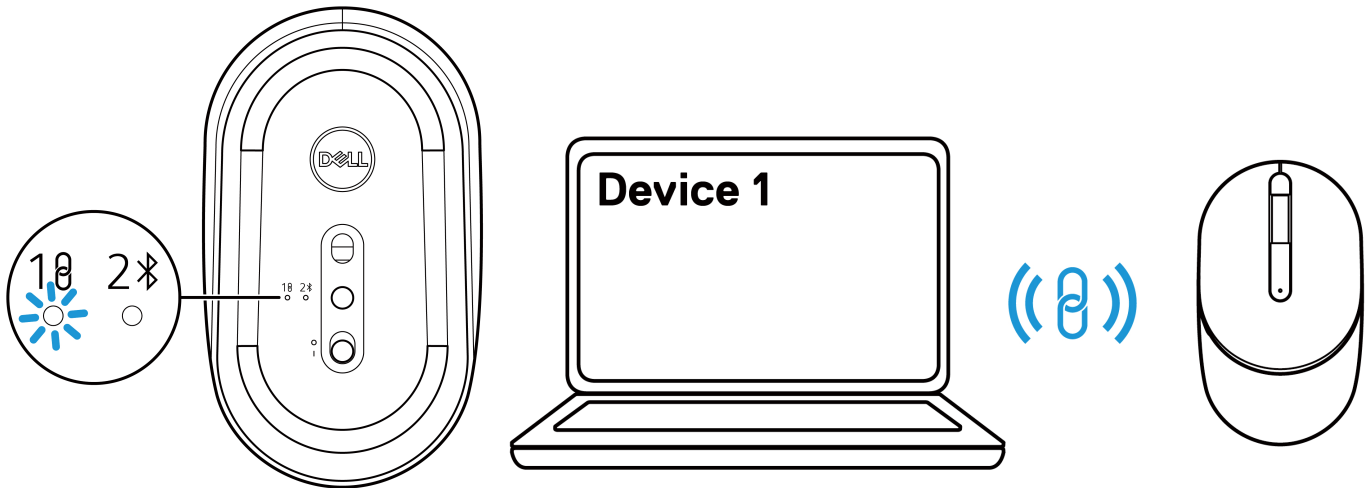
## Pairing your wireless mouse using the Dell Secure Link USB Receiver

To pair your mouse using the Dell Secure Link USB Receiver, connect the Dell Secure Link USB Receiver to the USB port of your computer.



**Figure 8.** Connecting the Dell Secure Link USB Receiver

The connection-mode LED indicator (10) on the mouse lights up for 30 seconds to indicate the pairing process is in progress, and then turns off. The mouse is paired with your computer.



**Figure 9.** Mouse pairing in progress

**Figure 10.** The mouse pairing process is completed

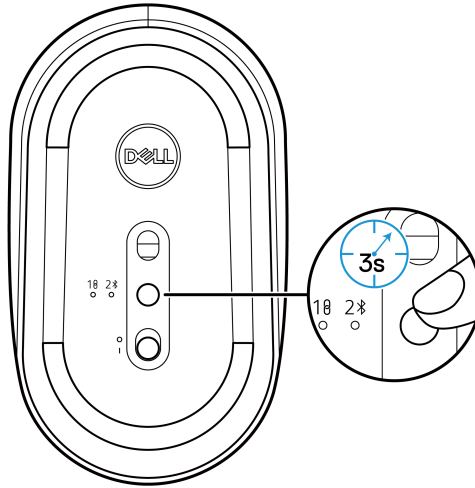
**NOTE:** A USB-C to USB-A adapter (sold separately) is required if your computer does not support USB-A port.

**NOTE:** The RF device is pre-paired in the factory.

## Pairing your wireless mouse using Bluetooth

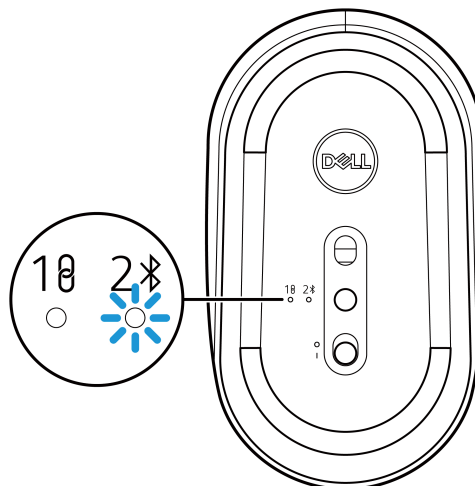
① **NOTE:** Before pairing your wireless mouse using Bluetooth, ensure that you update the Bluetooth driver on your Dell computer to the latest version. For more information, see Drivers & Downloads at <https://www.dell.com/support>.

1. Press the connection-mode button to switch to the Bluetooth pairing mode (2 ✂).
2. Press the connection-mode button for 3 seconds. Ensure that the Bluetooth LED (2 ✂) blinks white, indicating that the Bluetooth pairing process has been initiated.



**Figure 11.** Initiating the Bluetooth pairing mode

The connection-mode LED indicator (2 ✂) blinks for 3 minutes, indicating that your mouse is in the pairing mode.





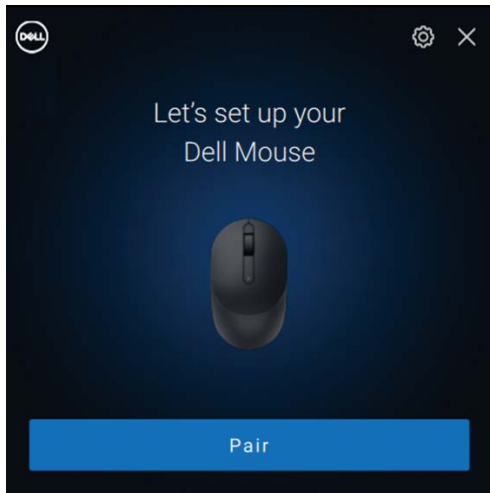
**Figure 12.** Mouse in the Bluetooth pairing mode

3. Pair your wireless mouse with your Bluetooth-enabled computer.

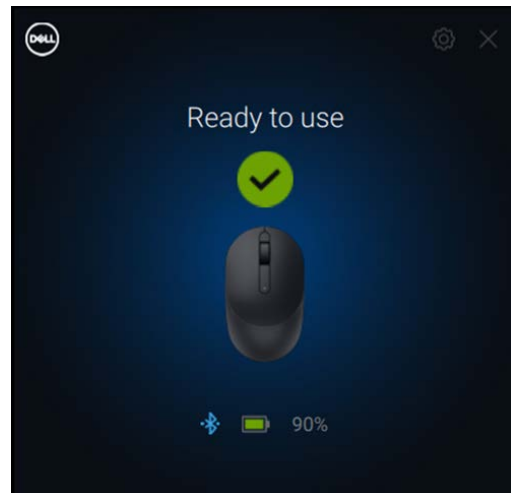
## Pairing your wireless mouse using Dell Pair

**NOTE:** Dell Pair is available with select accessories, commercial & consumer computers. Availability and functionality vary by model. For more details visit [Dell.com/support/kbdoc/000201693](https://Dell.com/support/kbdoc/000201693).

1. Ensure that Bluetooth of computer is turned on.
2. Place your wireless mouse near your computer. Then press the connection-mode button to switch to the Bluetooth pairing mode (2 )
3. Press the connection-mode button for three seconds. Ensure that the Bluetooth channel LED (2 ) blinks white, indicating the Bluetooth pairing is initiated.
4. The **Let's set up your Dell Keyboard** window appears. Click **Pair**.



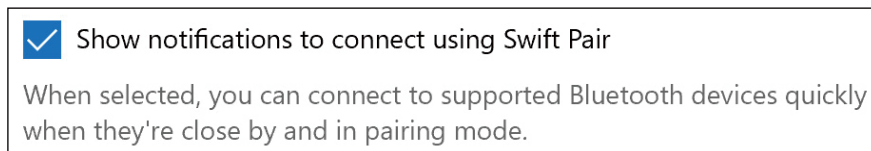
**Figure 13-1.** Pairing your wireless mouse using Dell Pair





**Figure 13-2.** Wireless mouse is successfully connected

## Pairing your wireless mouse using Swift Pair

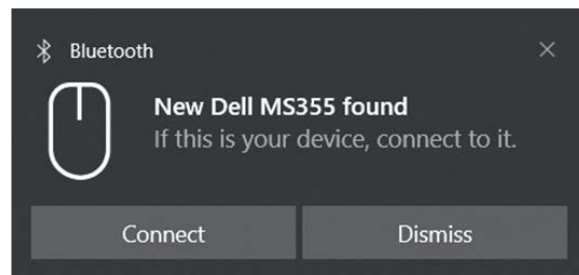
1. In Windows Search, type **Bluetooth**.
2. Click **Bluetooth and other devices settings**. The **Settings** window appears.
3. Select the **Show notifications to connect using Swift Pair** check box.



**Figure 14.** Enable Swift Pair

4. Turn on the Bluetooth.
5. Place your wireless mouse near your computer. Then press the connection-mode button to switch to the Bluetooth pairing mode (2 )
6. Press the connection-mode button for three seconds. Ensure that the Bluetooth channel LED (2 ) blinks white, indicating the Bluetooth pairing is initiated.

The **New Dell MS355 found** window appears.



**Figure 15.** Pairing your wireless mouse using Swift Pair

7. Click **Connect** to confirm the pairing process between wireless mouse and your computer.

## Add device

1. Select **Start > Settings > Devices > Bluetooth & other devices > Add Bluetooth or other device > Bluetooth.**
2. Select **Dell MS355**, and then click **Done**.

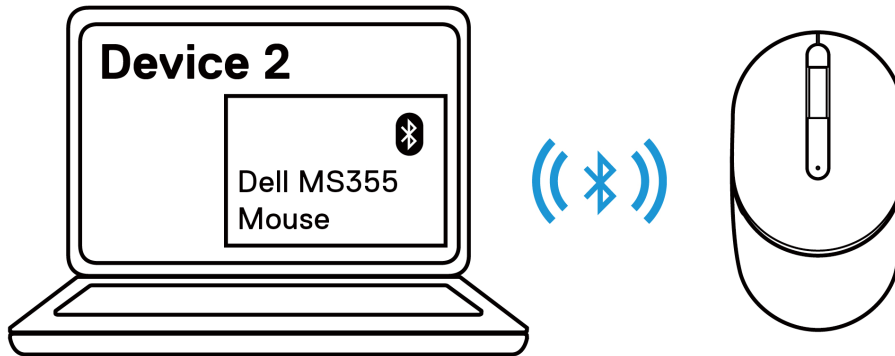
**(i) NOTE:** If Dell MS355 is not listed in your computer, check and ensure that the pairing mode is enabled on the mouse.

3. Confirm the pairing process on both the wireless mouse and your computer.

The Bluetooth LED (2) turns solid white for a few seconds to confirm the pairing, and then the light turns off. After your mouse and computer pairing is completed, the mouse connects to the computer automatically when the Bluetooth is enabled and both devices are within the Bluetooth range.



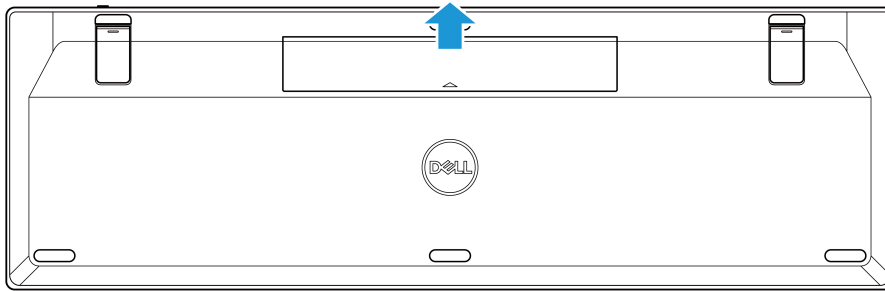
**Figure 16.** The mouse pairing process is completed (1 of 2)



**Figure 17.** The mouse pairing process is completed (2 of 2)

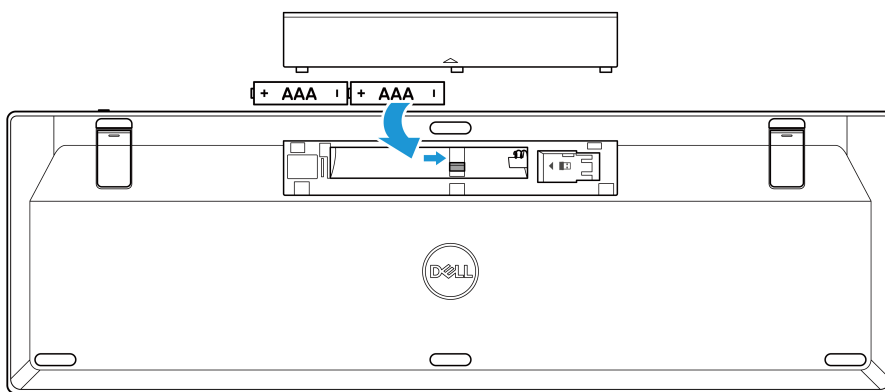
# Setting up your wireless keyboard

1. Remove the battery cover.



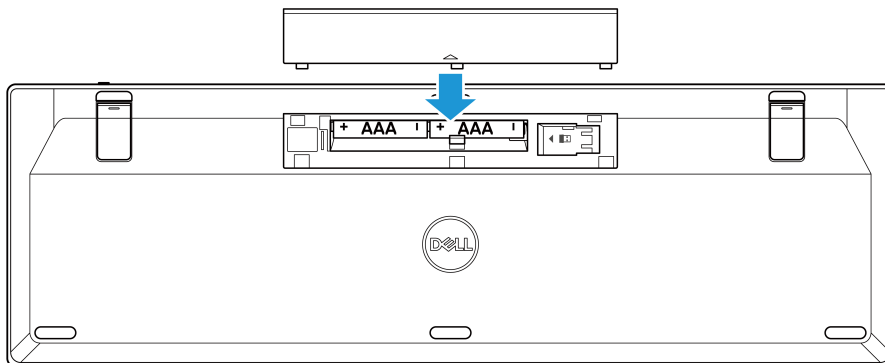
**Figure 18.** Removing the battery cover

2. Install the AAA batteries into the battery compartment.



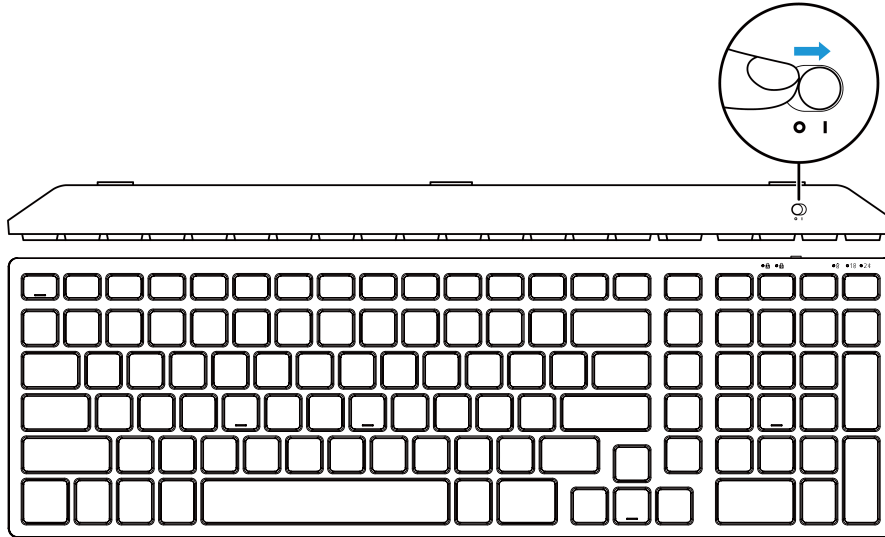
**Figure 19.** Installing the batteries

3. Replace the battery cover.



**Figure 20.** Replacing the battery cover

- Slide the power switch to the right to turn on the wireless keyboard.



**Figure 21.** Turning on the keyboard

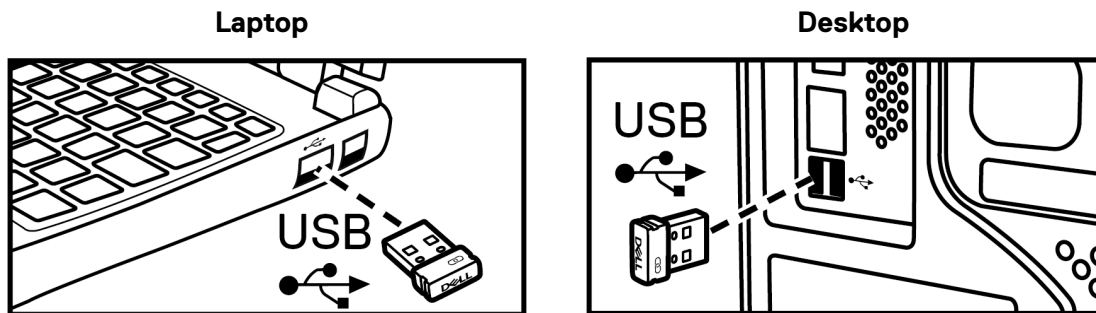
**NOTE:** Ensure that the distance between your computer and wireless keyboard is within ten meters.

## Pairing your wireless keyboard

Your Dell wireless keyboard can be paired with devices using either the Dell Secure Link USB Receiver or Bluetooth. You can pair and switch between a laptop, desktop, or any compatible mobile device.

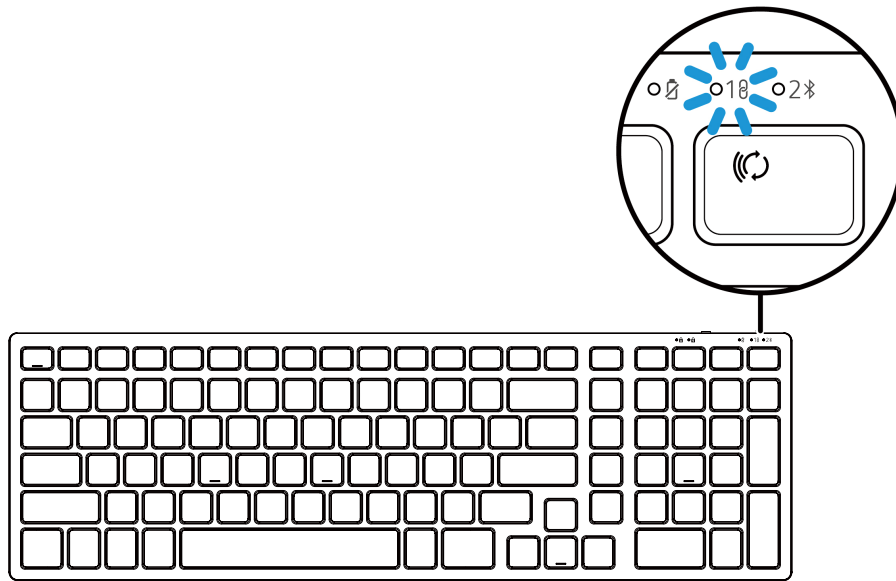
### Pairing your wireless keyboard using the Dell Secure Link USB Receiver

To pair your wireless keyboard using the Dell Secure Link USB Receiver, connect the Dell Secure Link USB Receiver to the USB port of your computer.

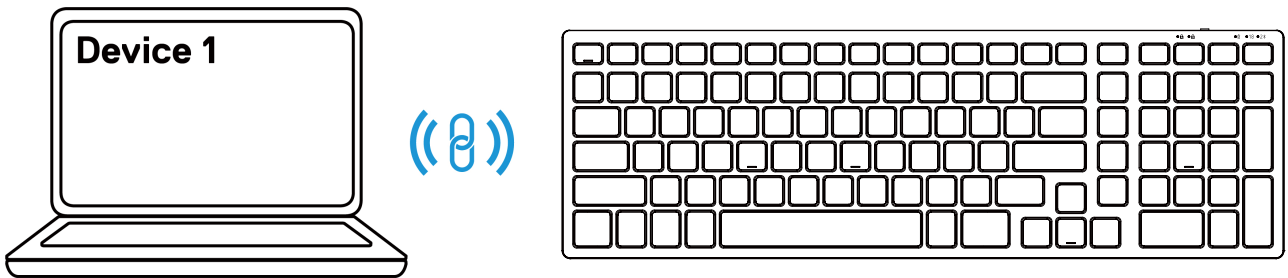


**Figure 22.** Connecting the Dell Secure Link USB Receiver

The connection-mode LED indicator (10) on the keyboard lights up for 30 seconds to indicate the pairing process is in progress, and then turns off. The keyboard is paired with your computer.



**Figure 23.** Dell secure link USB receiver connection selected

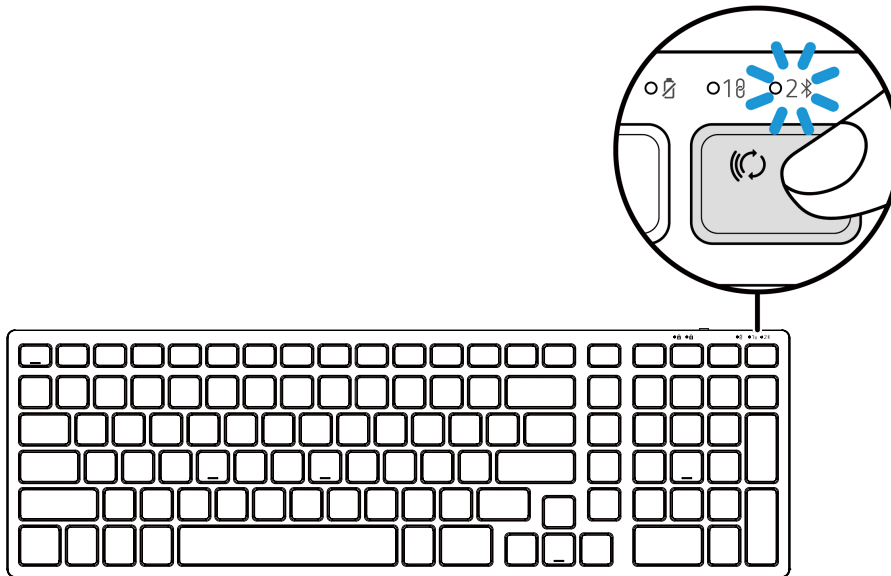


**Figure 24.** The keyboard pairing process is completed

- ① **NOTE:** A USB-C to USB-A adapter (sold separately) is required if your computer does not support USB-A port.
- ① **NOTE:** The RF device is pre-paired in the factory.

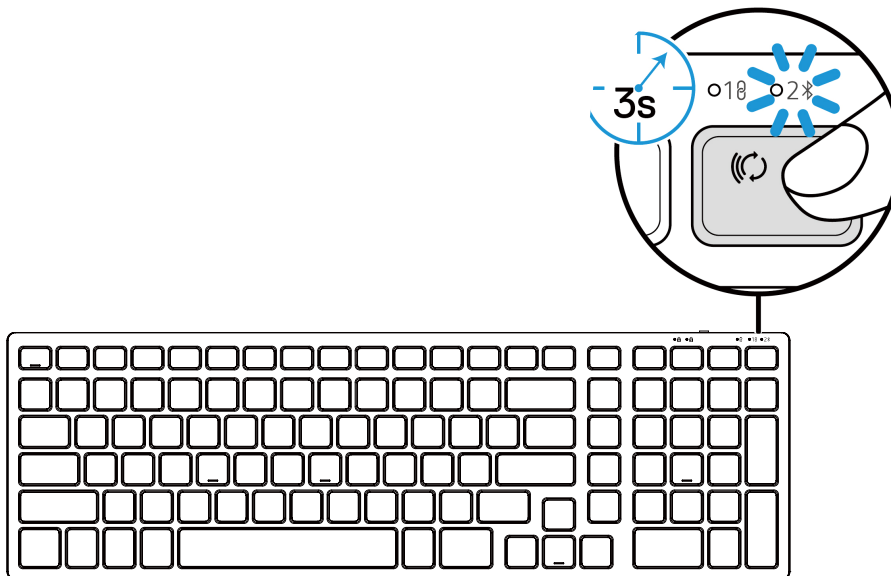
## Pairing your wireless keyboard using Bluetooth

- ① **NOTE:** Before pairing your wireless keyboard using Bluetooth, ensure that you update the Bluetooth driver on your Dell computer to the latest version. For more information, see Drivers & Downloads at <https://www.dell.com/support>.
1. Press the connection-mode key on your keyboard until the connection-mode LED indicator (2) lights up, indicating that the Bluetooth connection is selected.



**Figure 25.** The Bluetooth mode is selected

2. Press the connection-mode key for 3 seconds. Ensure that the Bluetooth LED (2) blinks white, indicating that the pairing is initiated. The connection-mode LED indicator (2) blinks for 3 minutes, indicating that your wireless keyboard is in the pairing mode.



**Figure 26.** Initiating the Bluetooth pairing mode

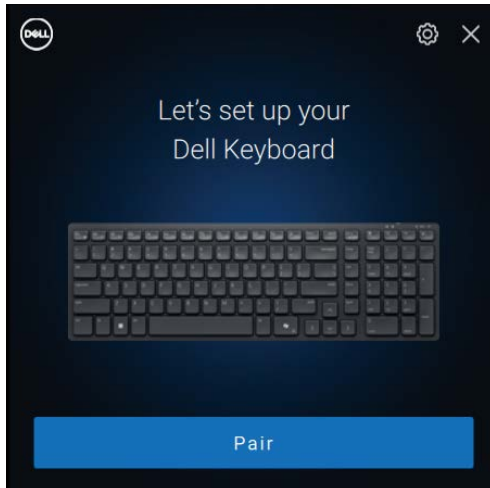
3. Pair your wireless keyboard with your Bluetooth-enabled computer.



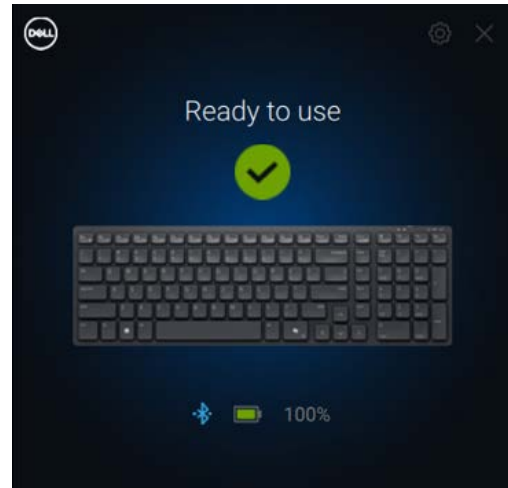
## Pairing your wireless keyboard using Dell Pair

**NOTE:** Dell Pair is available with select accessories, commercial & consumer computers. Availability and functionality vary by model. For more details visit [Dell.com/support/kbdoc/000201693](https://Dell.com/support/kbdoc/000201693).

1. Ensure that Bluetooth of computer is turned on.
2. Place your wireless keyboard near your computer. Then press the connection-mode key to switch to the Bluetooth pairing mode (2 $\times$ ).
3. Press the connection-mode key for three seconds. Ensure that the Bluetooth channel LED (2 $\times$ ) blinks white, indicating the Bluetooth pairing is initiated.
4. The **Let's set up your Dell Keyboard** window appears. Click **Pair**.



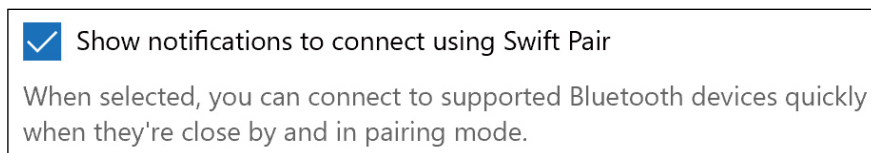
**Figure 27-1.** Pairing your wireless keyboard using Dell Pair



**Figure 27-2.** You will see this when pairing success.

## Pairing your keyboard using Swift Pair

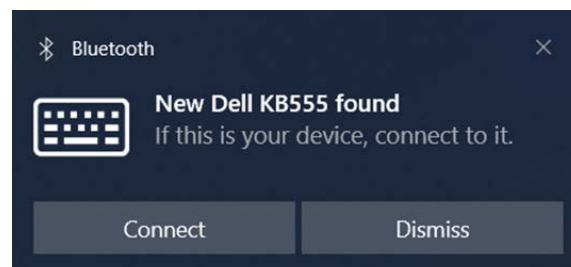
1. In Windows Search, type **Bluetooth**.
2. Click **Bluetooth and other devices settings**. The **Settings** window appears.
3. Select the **Show notifications to connect using Swift Pair** check box.



**Figure 28.** Enable Swift Pair

4. Turn on the Bluetooth.
5. Place your wireless keyboard near your computer. Then press the connection-mode key to switch to the pairing mode (2 $\times$ ).
6. Press the connection-mode key for three seconds. Ensure that the Bluetooth channel LED (2 $\times$ ) blinks white, indicating the Bluetooth pairing is initiated

The **New Dell KB555 found** window appears.

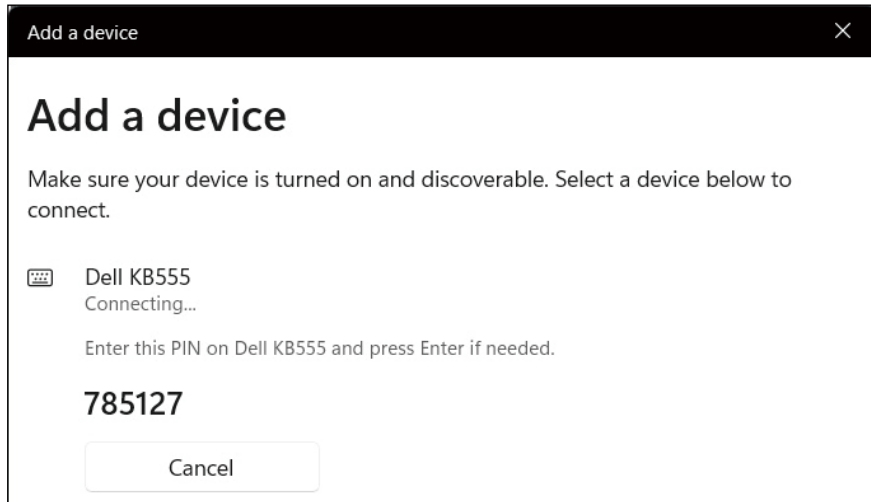


**Figure 29.** Pairing your wireless keyboard with Swift Pair

7. Click **Connect** to confirm the pairing process between the wireless wireless keyboard and your computer.

## Add device

1. Select **Start > Settings > Devices > Bluetooth & other devices > Add Bluetooth or other device > Bluetooth**.
2. Select **Dell KB555**.
3. Enter the pairing code on the wireless keyboard, and then press **Enter**.



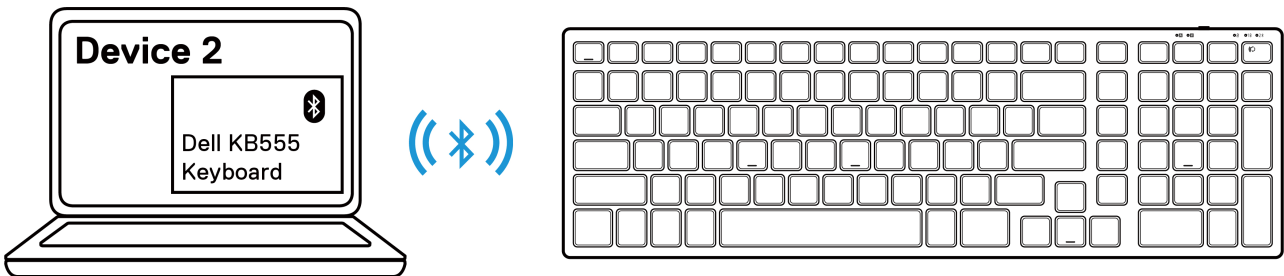
**Figure 30.** Bluetooth pairing in progress

4. Click **Done**.

The Bluetooth LED (2) turns solid white for a few seconds to confirm the pairing, and then the light turns off. After your keyboard and computer pairing is completed, the keyboard connects to the computer automatically when the Bluetooth is enabled and both devices are within the Bluetooth range.



**Figure 31.** The keyboard pairing process is completed (1 of 2)



**Figure 32.** The keyboard pairing process is completed (2 of 2)

# Specifications

**Table 4.** Wireless mouse specifications.

Specifications	Value
Model number	MS355
Connection type	Dual Wireless (Bluetooth 5.1 and 2.4 GHz with Dell Secure Link USB Receiver)
System requirement	<ul style="list-style-type: none"> <li>• Windows XP (Dell Secure Link USB Receiver only)</li> <li>• Windows Vista (Dell Secure Link USB Receiver only)</li> <li>• Windows 7, 32/64 bit (Dell Secure Link USB Receiver only)</li> <li>• Windows Server 2003 (Dell Secure Link USB Receiver only)</li> <li>• Windows Server 2008; 2008 R2 (Dell Secure Link USB Receiver only)</li> <li>• Windows Server 2012; 2012 R2, 2016 (Dell Secure Link USB Receiver only)</li> <li>• Windows 8, 32/64 bit, Windows8.1 (Basic function only)</li> <li>• Android</li> <li>• Chrome</li> <li>• iOS, MacOS, iPadOS</li> <li>• Linux (Ubuntu v18.04 LTS, Redhat 8.0+)</li> <li>• Free-DOS (Dell Secure Link USB Receiver only)</li> </ul>
Operating voltage	1.6 V to 0.9 V
Battery type	One AA alkaline
Weight (with battery)	89 g (0.196 lb)
Weight (without battery)	67 g (0.148 lb)
Length	104.46 mm (4.113 in.)
Width	60.28 mm (2.373 in.)
Height	38 mm (1.496 in.)
Operating	-0°C to 40°C (32°F to 104°F)
Storage	-40°C to 65°C (-40°F to 149°F)
Storage humidity	95% maximum relative humidity; non-condensing
RF protocol	<ul style="list-style-type: none"> <li>• Bluetooth 5.1</li> <li>• 2.4 GHz RF</li> </ul>
Range	<ul style="list-style-type: none"> <li>• Up to 10 m radio range.</li> <li>• No performance degradation up to maximum radio range (10 m).</li> </ul>

**Table 5.** Wireless keyboard specifications.

<b>Specifications</b>	<b>Value</b>
Model number	KB555
Connection type	Dual Wireless (Bluetooth 5.1 and 2.4 GHz with Dell Secure Link USB Receiver)
System requirement	<ul style="list-style-type: none"> <li>• Windows XP (Dell Secure Link USB Receiver only)</li> <li>• Windows Vista (Dell Secure Link USB Receiver only)</li> <li>• Windows 7, 32/64 bit (Dell Secure Link USB Receiver only)</li> <li>• Windows Server 2003 (Dell Secure Link USB Receiver only)</li> <li>• Windows Server 2008; 2008 R2 (Dell Secure Link USB Receiver only)</li> <li>• Windows Server 2012; 2012 R2, 2016 (Dell Secure Link USB Receiver only)</li> <li>• Windows 8, 32/64 bit, Windows8.1 (Basic function only)</li> <li>• Android</li> <li>• Chrome</li> <li>• iOS, MacOS, iPadOS</li> <li>• Linux (Ubuntu v18.04 LTS, Redhat 8.0+)</li> <li>• Free-DOS (Dell Secure Link USB Receiver only)</li> </ul>
Operating voltage	2.0 V ~ 3.2 V
Battery type	Two AAA alkaline batteries
Weight (with battery)	428 g
Weight (without battery)	406 g
Length	398.60 mm (15.69 in.)
Width	126.86 mm (4.99 in.)
Height	26.27 mm (1.03 in.)
Operating	-0°C to 40°C (32°F to 104°F)
Storage	-40°C to 65°C (-40°F to 149°F)
Storage humidity	95% maximum relative humidity; non-condensing
RF protocol	<ul style="list-style-type: none"> <li>• Bluetooth 5.1</li> <li>• 2.4 GHz RF</li> </ul>
Range	<ul style="list-style-type: none"> <li>• Up to 10 m radio range.</li> <li>• No performance degradation up to maximum radio range (10 m).</li> </ul>

# Troubleshooting

**Table 6.** Troubleshooting.

Problems	Possible solutions
Unable to use the wireless mouse/wireless keyboard.	<ol style="list-style-type: none"> <li>1. Check if the batteries are inserted in the correct orientation. The battery “+” and “-” ends should be placed as indicated on the battery compartment.</li> <li>2. Check the battery level.               <ul style="list-style-type: none"> <li>• If the wireless mouse/wireless keyboard uses rechargeable batteries, ensure that the batteries are fully charged.</li> <li>• If the batteries are exhausted, replace them with the new ones.</li> </ul> </li> <li>3. Turn the wireless mouse/wireless keyboard off, and then turn it on again. Check if the low battery LED indicator is flashing amber, indicating that the battery power is low. If the battery is fully depleted, the low battery LED indicator will not turn on.</li> <li>4. Ensure that the Dell Secure Link USB Receiver is directly connected to your computer.</li> <li>5. Change the USB port. Insert the Dell Secure Link USB Receiver into another USB port on your computer.</li> <li>6. Update the Bluetooth driver on your computer:               <ol style="list-style-type: none"> <li>1. Open the web browser and download the latest Bluetooth drivers from <a href="https://www.dell.com/support">https://www.dell.com/support</a>.</li> <li>2. Restart your computer.</li> </ol> </li> </ol>
Keyboard or mouse buttons do not work.	<ol style="list-style-type: none"> <li>1. Ensure that the battery is fully charged.</li> <li>2. Turn off the keyboard or mouse, and then turn it on.</li> <li>3. On your computer, turn the Bluetooth off and on.</li> <li>4. Restart your computer.</li> <li>5. Check for interference that may affect Bluetooth connectivity such as, nearby Wifi and USB 3.0 devices.               <ul style="list-style-type: none"> <li>• Check for any wireless devices that are in close proximity such as wireless networking devices (Bluetooth printer and USB 3.0 dongle), wireless pointing devices, and microwave ovens.</li> <li>• Move away from these devices.</li> </ul> </li> </ol>

Problems	Possible solutions
<p>Unable to pair the wireless mouse/wireless keyboard with the computer using Bluetooth.</p>	<ol style="list-style-type: none"> <li>1. Check the battery level. <ul style="list-style-type: none"> <li>• If the wireless mouse/wireless keyboard uses rechargeable batteries, ensure that the batteries are fully charged.</li> <li>• If the batteries are exhausted, replace them with the new ones.</li> </ul> </li> <li>2. Turn the wireless mouse/wireless keyboard off, and then turn it on again. Check if the low battery LED indicator is flashing amber, indicating that the battery power is low. If the battery is fully depleted, the low battery LED indicator will not turn on.</li> <li>3. On your computer, turn the Bluetooth off and on.</li> <li>4. Restart your computer. Check if you have the latest Bluetooth driver installed on your computer. Go to <a href="http://www.dell.com/support">www.dell.com/support</a> and update the correct Bluetooth driver. For more information, see Download and install the Bluetooth driver.</li> <li>5. Check the operating system is Windows 11/Windows 10/Windows 8/ Chrome/Android.</li> <li>6. Ensure that the Bluetooth device is in pairing mode. See <a href="#">Pairing your wireless mouse using Bluetooth</a> or <a href="#">Pairing your wireless keyboard using Bluetooth</a> in this user guide.</li> <li>7. Ensure that the wireless mouse/wireless keyboard is set to Bluetooth Low Energy (BLE) mode in your computer. For more information, see the documentation that came with your computer.</li> </ol>
<p>Wireless mouse pointer does not move or left/right buttons do not work.</p>	<ol style="list-style-type: none"> <li>1. Check the battery level. <ul style="list-style-type: none"> <li>• If the wireless mouse uses a rechargeable battery, ensure that the battery is fully charged.</li> <li>• If the battery is exhausted, replace it with a new one.</li> </ul> </li> <li>2. Turn the wireless mouse off, and then turn it on. Check if the low battery LED indicator is flashing amber for ten times, indicating that the battery power is low. If the battery is fully depleted, the battery-status will not turn on.</li> <li>3. Restart your computer.</li> </ol>
<p>Unable to pair the wireless mouse/wireless keyboard with the computer.</p>	<ol style="list-style-type: none"> <li>1. Check the battery level. <ul style="list-style-type: none"> <li>• If the wireless mouse/wireless keyboard uses rechargeable batteries, ensure that the batteries are fully charged.</li> <li>• If the batteries are exhausted, replace them with the new ones.</li> </ul> </li> <li>2. Turn the wireless mouse/wireless keyboard off, and then turn it on again. Check if the low battery LED indicator is flashing amber, indicating that the battery power is low. If the battery is fully depleted, the low battery LED indicator will not turn on.</li> <li>3. Ensure your wireless mouse/keyboard is with the correct connection mode (RF or Bluetooth).</li> <li>4. Restart your computer.</li> </ol>

Problems	Possible solutions
<p>Wireless connection is lost.</p>	<ol style="list-style-type: none"> <li>1. Ensure that the Dell Secure Link USB Receiver is connected directly to your computer.</li> <li>2. Check the battery level. <ul style="list-style-type: none"> <li>• If the wireless mouse/wireless keyboard uses rechargeable batteries, ensure that the batteries are fully charged.</li> <li>• If the batteries are exhausted, replace them with the new ones.</li> </ul> </li> <li>3. Turn the wireless mouse/wireless keyboard off, and then turn it on again. Check if the low battery LED indicator is flashing amber for ten times, indicating that the battery power is low. If the battery is fully depleted, the low battery LED indicator will not turn on.</li> <li>4. On your computer, turn the Bluetooth off and on.</li> <li>5. Restart your computer. Check if you have the latest Bluetooth driver installed on your computer. Go to <a href="http://www.dell.com/support">www.dell.com/support</a> and update the correct Bluetooth driver. For more information, see Download and install the Bluetooth driver.</li> <li>6. Check for interference that may affect Bluetooth or Wifi connectivity such as, nearby Wifi and USB 3.0 devices. <ul style="list-style-type: none"> <li>• Check for any wireless devices that are in close proximity such as wireless networking devices (Bluetooth printer and USB 3.0 dongle), wireless pointing devices, and microwave ovens.</li> <li>• Move away from these devices.</li> </ul> </li> <li>7. Ensure that the distance between your laptop, desktop, or a compatible mobile device where the Dell Secure Link USB Receiver is connected is within 1m.</li> <li>8. Ensure that the USB-A port where the Dell Secure Link USB Receiver is connected is not close to the USB-A port(s) where other devices are connected.</li> <li>9. If necessary, connect the Dell Secure Link USB Receiver to the dongle extender and check the wireless connection again.</li> </ol>
<p>Keyboard key presses are lagging, auto-repeating, and erratic. Mouse movement and button clicks are lagging and erratic.</p>	<ol style="list-style-type: none"> <li>1. Check for interference that may affect Bluetooth or RF connectivity such as, nearby Wifi and USB 3.0 devices. <ul style="list-style-type: none"> <li>• Check for any wireless devices that are in close proximity such as wireless networking devices (Bluetooth printer and USB 3.0 dongle), wireless pointing devices, and microwave ovens.</li> <li>• Move away from these devices.</li> </ul> </li> <li>2. Ensure that the distance between your laptop, desktop, or a compatible mobile device where the Dell Secure Link USB Receiver is connected is within 1m.</li> <li>3. Ensure that the USB-A port where the Dell Secure Link USB Receiver is connected is not close to the USB-A port(s) where other devices are connected.</li> <li>4. If necessary, connect the Dell Secure Link USB Receiver to the dongle extender and check the wireless connection again.</li> </ol>

# Statutory Information

## Warranty

### Limited warranty and return policies

Dell-branded products carry a three-year limited hardware warranty. If purchased together with Dell system, it will follow the system warranty.

#### For U.S. customers:

This purchase and your use of this product are subject to Dell's end user agreement, which you can find at [Dell.com/terms](https://www.dell.com/terms). This document contains a binding arbitration clause.

#### For European, Middle Eastern and African customers:

Dell-branded products that are sold and used are subject to applicable national consumer legal rights, the terms of any retailer sale agreement that you have entered into (which will apply between you and the retailer) and Dell's end user contract terms.

Dell may also provide an additional hardware warranty – full details of the Dell end user contract and warranty terms can be found by going to [Dell.com/terms](https://www.dell.com/terms), selecting your country from the list at the bottom of the “home” page and then clicking the “terms and conditions” link for the end user terms or the “support” link for the warranty terms.

#### For non-U.S. customers:

Dell-branded products that are sold and used are subject to applicable national consumer legal rights, the terms of any retailer sale agreement that you have entered into (which will apply between you and the retailer) and Dell's warranty terms. Dell may also provide an additional hardware warranty – full details of Dell's warranty terms can be found by going to [Dell.com](https://www.dell.com), selecting your country from the list at the bottom of the “home” page and then clicking the “terms and conditions” link or the “support” link for the warranty terms.