

EPSON

DS-900WN DS-800WN

User's Guide

Product Features

Scanner Basics

Specifications and Placing of Originals

Scanning

Maintenance

Solving Problems

Contents

About This Manual

Introduction to the Manuals.	7
Marks and Symbols.	7
Descriptions Used in this Manual.	7
Operating System References.	8
Copyright.	8
Trademarks.	9

Important Instructions

Safety Instructions.	11
Restrictions on Copying.	12
Advisories and Warnings for Using the Touchscreen.	12
Advisories and Warnings for Connecting to the Internet.	13
Protecting Your Personal Information.	13
Notes on the Administrator Password.	13
Initial Administrator Password.	13
Operations that Require the Administrator Password.	13
Changing the Administrator Password.	14
Resetting the Administrator Password.	14

Product Features

Epson's Network Scanning Technology "ScanWay".	16
Providing Authentication Options for a Secure Scanning Environment.	16
Scanning Functions that Support High Productivity.	17
Useful Image Quality Adjustment Features.	17

Scanner Basics

Part Names and Functions.	22
Paper Alignment Plate.	24
Attaching the Paper Alignment Plate.	24
Removing the Paper Alignment Plate.	25
Control Panel.	25
Buttons and Lights.	25
Basic Screen Composition.	26
Inserting and Removing a USB Drive.	30
Inserting a USB Drive.	31
Removing a USB Drive.	31
Information on Applications.	32

Application for Scanning Documents (Document Capture Pro / Document Capture).	32
Application for Controlling the Scanner (Epson Scan 2).	32
Application for Scanning from Smart Devices (Epson Smart Panel).	33
Application for Updating Software and Firmware (EPSON Software Updater).	33
Application for Configuring Scanner Operations (Web Config).	34
Application for Setting up the Device on a Network (EpsonNet Config).	35
Software for Managing Devices on the Network (Epson Device Admin).	36
Application for Creating Driver Packages (EpsonNet SetupManager).	36
Software that uses a Server for Authenticated Scanning (Epson Print Admin).	36
Software that does not use a Server for Authenticated Scanning (Epson Print Admin Serverless).	37
Option Items and Consumables Information.	37
Carrier Sheet Codes.	37
Roller Assembly Kit Codes.	38
Paper Alignment Plate Codes.	38
Cleaning Kit Codes.	39

Specifications and Placing of Originals

Specifications for Originals that can be Scanned.	41
General Specifications for Originals being Scanned.	41
Types of Originals that Require Attention.	46
Types of Originals that Must Not be Scanned.	46
Placing Originals.	47
Standard Size Originals.	47
Long Paper.	52
Plastic Cards.	56
Laminated Cards.	59
Large Size Originals.	61
Irregular Shaped Originals.	64
Photographs.	67
Envelopes.	69
Mixture of Originals.	72

Scanning

Scanning Using the Scanner's Control Panel.	77
---	----

Scanning Originals to a Computer.	77
Scanning to a Network Folder.	78
Scanning Originals to an Email.	83
Scanning to the Cloud.	87
Scanning to a USB Drive.	91
Scanning Using WSD.	95
Combinations for Available File Format and Image Type.	95
Scanning Using Presets Settings.	97
Scanning from a Computer.	97
Scanning Using Document Capture Pro (Windows).	97
Scanning Using Document Capture (Mac OS).	104
Scanning Using Epson Scan 2.	110
Software Image Quality Adjustment Features.	115
Scanning from a Computer Using a Scanner with Access Control Enabled.	115
Using AirPrint.	115
Scanning Using Chromebook.	116
Setting a Job.	116
Creating a Job and Assigning a Job to the Control Panel (Windows).	117
Creating and Registering a Job (Mac OS).	117
Assigning a Job to the Control Panel (Mac OS).	117
Scanning in Automatic Feeding Mode.	118
Scanning from a Smart Device.	120
Scanning Using Epson Smart Panel.	120
Scanning Using Mopria Scan.	121

Required Settings for Scanning

Connecting the Scanner to the Network.	123
Registering an Email Server.	123
Checking an Email Server Connection.	124
Creating a Network Folder.	126
Making Contacts Available.	132
Contacts Configuration Comparison.	133
Registering a Destination to Contacts using Web Config.	133
Registering Destinations as a Group Using Web Config.	135
Backing Up and Importing Contacts.	136
Export and Bulk Registration of Contacts Using Tool.	137
Cooperation between the LDAP Server and Users.	138
Setting Up AirPrint.	141

Customizing the Control Panel Display

Registering Presets.	144
Menu Options of Presets.	145
Editing the Home Screen of the Control Panel.	146
Changing the Layout of the Home Screen.	146
Add Icon.	147
Remove Icon.	148
Move Icon.	149

Menu Options for Settings

Basic Settings.	151
LCD Brightness.	151
Sounds.	151
Sleep Timer.	151
Power Off Settings.	151
Direct power on.	151
Date/Time Settings.	151
Language.	151
Keyboard.	152
Operation Time Out.	152
PC Connection via USB.	152
Scanner Settings.	152
Edit Home.	153
User Settings.	154
Network Settings.	154
Wi-Fi Setup:.	154
Wired LAN Setup:.	155
Network Status.	155
Advanced.	155
Web Service Settings.	155
Document Capture Pro.	156
Contacts Manager.	156
System Administration.	156
Contacts Manager.	156
Admin Settings.	157
Restrictions.	157
Access Control:.	157
Password Encryption.	157
Program Verification on Start Up.	157
Customer Research.	157
WSD Settings.	157
Restore Default Settings.	157
Firmware Update:.	158
Device Information.	158
Scanner Maintenance.	159
Roller Replacement Alert Setting.	159

Regular Cleaning Alert Settings. 159

Maintenance

Cleaning Outside the Scanner. 161
 Cleaning Inside the Scanner. 161
 Replacing the Roller Assembly Kit. 166
 Resetting the Number of Scans After Replacing
 the Rollers. 171
 Energy Saving. 171
 Transporting the Scanner. 171
 Updating Applications and Firmware. 172
 Updating the Scanner's Firmware using the
 Control Panel. 173
 Updating Firmware Using Web Config. 174
 Updating Firmware without Connecting to
 the Internet. 174

Solving Problems

Problems with the Scanner. 176
 Checking Error Messages on the Control Panel. 176
 The Scanner Does Not Turn On. 176
 The Scanner Turns Off Unexpectedly. 177
 Forgot Your Administrator's Password. 177
 Problems when Preparing Network Scanning. 177
 Hints to Solving Problems. 177
 Cannot Access Web Config. 178
 Problems Starting Scanning. 179
 Cannot Start Scanning from Computer. 179
 Cannot Start Scanning from Smart Device. 184
 Cannot Save Scanned Images to the Shared
 Folder. 187
 Cannot Send Scanned Images to the Cloud. 188
 Cannot Send Scanned Images to an Email. 188
 Paper Feeding Problems. 189
 Multiple Originals Are Fed (Double Feed). 189
 Removing Jammed Originals from the Scanner. 189
 Paper Jams, Paper Feed Errors, and
 Document Protection Issues Occur Frequently. 191
 Paper Protection Does not Work Correctly. 192
 Originals are not Ejected Neatly. 192
 The Originals Get Dirty. 193
 Scanning Speed Slows Down when Scanning
 Continuously. 193
 Scanning Takes a Long Time. 193
 Scanned Image Problems. 194
 Lines (Streaks) Appear when Scanning from
 ADF. 194

Alert About Stains Inside the Scanner Still
 Appears. 194
 Colors Are Uneven in the Scanned Image. 195
 Expanding or Contracting the Scanned Image. . . 195
 An Image on the Back of Your Original
 Appears in Your Scanned Image. 195
 Scanned Text or Images are Missing or Blurred. 196
 Moiré Patterns (Web-Like Shadows) Appear. . . . 197
 The Edge of the Original is Not Scanned
 when Automatically Detecting the Size of the
 Original. 197
 Character is not Recognized Correctly. 198
 Cannot Solve Problems in the Scanned Image. . 198
 Document Capture Pro Problems. 199
 Uninstalling and Installing Applications. 199
 Uninstalling Your Applications. 199
 Installing Your Applications. 200

Adding or Replacing the Computer or Devices

Connecting to a Scanner that has been
 Connected to the Network. 203
 Using a Network Scanner from a Second
 Computer. 203
 Using a Network Scanner from a Smart Device. 204
 Connecting a Smart Device and Scanner
 Directly (Wi-Fi Direct). 204
 About Wi-Fi Direct. 204
 Connecting to a Smart Device using Wi-Fi
 Direct. 205
 Disconnecting Wi-Fi Direct (Simple AP)
 Connection. 205
 Changing the Wi-Fi Direct (Simple AP)
 Settings Such as the SSID. 205
 Re-setting the Network Connection. 206
 When Replacing the Wireless Router. 206
 When Changing the Computer. 207
 Changing the Connection Method to the
 Computer. 207
 Making Wi-Fi Settings from the Control Panel. .208
 Checking the Network Connection Status. 211
 Checking the Network Connection Status
 from the Control Panel. 211
 Checking the Network of the Computer
 (Windows only). 212

Technical Specifications

General Scanner Specifications. 215
 Network Specifications. 216

Wi-Fi Specifications.	216
Ethernet Specifications.	217
Network Features and IPv4/IPv6 Support.	217
Security Protocol.	218
Supported Third Party Services.	218
USB Drive Specifications.	218
Using Port for the Scanner.	218
Dimensions and Weight Specifications.	220
Electrical Specifications.	221
Scanner Electrical Specifications.	221
AC Adapter Electrical Specifications.	223
Environmental Specifications.	223
System Requirements.	223

Standards and Approvals

Standards and Approvals for European Models.	225
Standards and Approvals for Australian Models.	225
Standards and Approvals for U.S. Models.	225
ZICTA Type Approval for Users in Zambia.	226

Where to Get Help

Technical Support Web Site.	228
Contacting Epson Support.	228
Before Contacting Epson.	228
Help for Users in Europe.	228
Help for Users in Taiwan.	228
Help for Users in Australia.	229
Help for Users in Singapore.	229
Help for Users in Thailand.	230
Help for Users in Vietnam.	230
Help for Users in Indonesia.	231
Help for Users in Malaysia.	231
Help for Users in India.	231
Help for Users in the Philippines.	232

About This Manual

Introduction to the Manuals.	7
Marks and Symbols.	7
Descriptions Used in this Manual.	7
Operating System References.	8
Copyright.	8
Trademarks.	9

Introduction to the Manuals

The latest versions of the following manuals are available from the Epson support website.

<http://www.epson.eu/support> (Europe)

<http://support.epson.net/>

Start Here (paper manual)

Provides you with information on setting up the product and installing the application.

User's Guide (digital manual)

Provides instructions on using the product, maintenance, and solving problems.

Administrator's Guide (digital manual)

Provides information for scanner administrators. It explains how to install the product in your network environment, make security settings, and administer the product.

As well as the manuals above, various manuals and help are included in the applications.

Marks and Symbols



Caution:

Instructions that must be followed carefully to avoid bodily injury.



Important:

Instructions that must be observed to avoid damage to your equipment.

Note:

Provides complementary and reference information.

Related Information

➔ Links to related sections.

Descriptions Used in this Manual

Screenshots for the applications are from Windows 10 or macOS High Sierra. The content displayed on the screens varies depending on the model and situation.

Illustrations used in this manual are for reference only. Although they may differ slightly from the actual product, the operating methods are the same.

Operating System References

Windows

In this manual, terms such as "Windows 11", "Windows 10", "Windows 8.1", "Windows 8", "Windows 7", "Windows Server 2022", "Windows Server 2019", "Windows Server 2016", "Windows Server 2012 R2", "Windows Server 2012", "Windows Server 2008 R2", and "Windows Server 2008" refer to the following operating systems. Additionally, "Windows" is used to refer to all versions.

- Microsoft® Windows® 11 operating system
- Microsoft® Windows® 10 operating system
- Microsoft® Windows® 8.1 operating system
- Microsoft® Windows® 8 operating system
- Microsoft® Windows® 7 operating system
- Microsoft® Windows Server® 2022 operating system
- Microsoft® Windows Server® 2019 operating system
- Microsoft® Windows Server® 2016 operating system
- Microsoft® Windows Server® 2012 R2 operating system
- Microsoft® Windows Server® 2012 operating system
- Microsoft® Windows Server® 2008 R2 operating system
- Microsoft® Windows Server® 2008 operating system

Mac OS

In this manual, "Mac OS" is used to refer to Mac OS X 10.9 or later as well as macOS 11 or later.

Copyright

No part of this publication may be reproduced, stored in a retrieval system, or transmitted in any form or by any means, electronic, mechanical, photocopying, recording, or otherwise, without the prior written permission of Seiko Epson Corporation. No patent liability is assumed with respect to the use of the information contained herein. Neither is any liability assumed for damages resulting from the use of the information herein. The information contained herein is designed only for use with this Epson product. Epson is not responsible for any use of this information as applied to other products.

Neither Seiko Epson Corporation nor its affiliates shall be liable to the purchaser of this product or third parties for damages, losses, costs, or expenses incurred by the purchaser or third parties as a result of accident, misuse, or abuse of this product or unauthorized modifications, repairs, or alterations to this product, or (excluding the U.S.) failure to strictly comply with Seiko Epson Corporation's operating and maintenance instructions.

Seiko Epson Corporation and its affiliates shall not be liable for any damages or problems arising from the use of any options or any consumable products other than those designated as Original Epson Products or Epson Approved Products by Seiko Epson Corporation.

Seiko Epson Corporation shall not be held liable for any damage resulting from electromagnetic interference that occurs from the use of any interface cables other than those designated as Epson Approved Products by Seiko Epson Corporation.

© 2024 Seiko Epson Corporation

The contents of this manual and the specifications of this product are subject to change without notice.

Trademarks

- Microsoft, Windows, Windows Server, Microsoft Edge, SharePoint, and Internet Explorer are trademarks of the Microsoft group of companies.
- Apple, Mac, macOS, OS X, Bonjour, Safari, and AirPrint are trademarks of Apple Inc., registered in the U.S. and other countries.
- Use of the Works with Apple badge means that an accessory has been designed to work specifically with the technology identified in the badge and has been certified by the developer to meet Apple performance standards.
- Chrome, Chromebook, Google Play and Android are trademarks of Google LLC.
- Wi-Fi®, Wi-Fi Direct®, and Wi-Fi Protected Access® are registered trademarks of Wi-Fi Alliance®. Wi-Fi Protected Setup™, WPA2™, WPA3™ are trademarks of Wi-Fi Alliance®.
- The SuperSpeed USB Trident Logo is a registered trademark of USB Implementers Forum, Inc.
- The Mopria™ word mark and the Mopria™ Logo are registered and/or unregistered trademarks of Mopria Alliance, Inc. in the United States and other countries. Unauthorized use is strictly prohibited.
- Firefox is a trademark of the Mozilla Foundation in the U.S. and other countries.
- QR Code is a registered trademark of DENSO WAVE INCORPORATED in Japan and other countries.
- General Notice: All other trademarks are the property of their respective owners and used for identification purposes only.

Important Instructions

Safety Instructions.	11
Restrictions on Copying.	12
Advisories and Warnings for Using the Touchscreen.	12
Advisories and Warnings for Connecting to the Internet.	13
Protecting Your Personal Information.	13
Notes on the Administrator Password.	13

Safety Instructions

Read and follow these instructions to ensure safe use of this product and options. Make sure you keep this manual for future reference. Also, be sure to follow all warnings and instructions marked on the product and options.

- Some of the symbols used on your product and options are to ensure safety and proper use of the product. Visit the following Web site to learn the meaning of the symbols.

<http://support.epson.net/symbols>

- Place the product and options on a flat, stable surface that extends beyond the base of the product and options in all directions. If you place the product and options by the wall, leave more than 10 cm between the back of the product and options and the wall.
- Place the product and options close enough to the computer for the interface cable to reach it easily. Do not place or store the product and options or the AC adapter outdoors, near excessive dirt or dust, water, heat sources, or in locations subject to shocks, vibrations, high temperature or humidity, direct sunlight, strong light sources, or rapid changes in temperature or humidity.
- Do not use with wet hands.
- Place the product and options near an electrical outlet where the adapter can be easily unplugged.
- The AC adapter cord should be placed to avoid abrasions, cuts, fraying, crimping, and kinking. Do not place objects on top of the cord and do not allow the AC adapter or the cord to be stepped on or run over. Be particularly careful to keep the cord straight at the end.
- Use only the power cord supplied with the product and do not use the cord with any other equipment. Use of other cords with this product or the use of the supplied power cord with other equipment may result in fire or electric shock.
- Use only the AC adapter that comes with your product. Using any other adapter could cause fire, electrical shock, or injury.
- The AC adapter is designed for use with the product with which it was included. Do not attempt to use it with other electronic devices unless specified.
- Use only the type of power source indicated on the AC adapter's label, and always supply power directly from a standard domestic electrical outlet with the AC adapter that meets the relevant local safety standards.
- When connecting this product and options to a computer or other device with a cable, ensure the correct orientation of the connectors. Each connector has only one correct orientation. Inserting a connector in the wrong orientation may damage both devices connected by the cable.
- Avoid using outlets on the same circuit as photocopiers or air control systems that regularly switch on and off.
- If you use an extension cord with the product, make sure the total ampere rating of the devices plugged into the extension cord does not exceed the cord's ampere rating. Also, make sure the total ampere rating of all devices plugged into the wall outlet does not exceed the wall outlet's ampere rating.
- Never disassemble, modify, or attempt to repair the AC adapter, product, or product options by yourself except as specifically explained in the product's guides.
- Do not insert objects into any opening as they may touch dangerous voltage points or short out parts. Beware of electrical shock hazards.
- If damage occurs to the plug, replace the cord set or consult a qualified electrician. If there are fuses in the plug, make sure you replace them with fuses of the correct size and rating.
- Unplug the product, options, and the AC adapter, and refer servicing to qualified service personnel under the following conditions: The AC adapter or plug is damaged; liquid has entered the product, options, or the AC adapter; the product or the AC adapter has been dropped or the case has been damaged; the product, options, or the AC adapter does not operate normally or exhibits a distinct change in performance. (Do not adjust controls that are not covered by the operating instructions.)

- Unplug the product and the AC adapter before cleaning. Clean with a damp cloth only. Do not use liquid or aerosol cleaners except as specifically explained in the product's guides.
- If you are not going to use the product for a long period, be sure to unplug the AC adapter from the electrical outlet.
- After replacing consumable parts, dispose of them correctly following the rules of your local authority. Do not disassemble them.
- Keep this product at least 22 cm away from cardiac pacemakers. Radio waves from this product may adversely affect the operation of cardiac pacemakers.
- Do not use this product inside medical facilities or near medical equipment. Radio waves from this product may adversely affect the operation of electrical medical equipment.
- Do not use this product near automatically controlled devices such as automatic doors or fire alarms. Radio waves from this product may adversely affect these devices, and could lead to accidents due to malfunction.
- If the LCD screen is damaged, contact your dealer. If the liquid crystal solution gets on your hands, wash them thoroughly with soap and water. If the liquid crystal solution gets into your eyes, flush them immediately with water. If discomfort or vision problems remain after a thorough flushing, see a doctor immediately.

Restrictions on Copying

Observe the following restrictions to ensure the responsible and legal use of your product.

Copying of the following items is prohibited by law:

- Bank bills, coins, government-issued marketable securities, government bond securities, and municipal securities
- Unused postage stamps, pre-stamped postcards, and other official postal items bearing valid postage
- Government-issued revenue stamps, and securities issued according to legal procedure

Exercise caution when copying the following items:

- Private marketable securities (stock certificates, negotiable notes, checks, etc.), monthly passes, concession tickets, etc.
- Passports, driver's licenses, warrants of fitness, road passes, food stamps, tickets, etc.

Note:

Copying these items may also be prohibited by law.

Responsible use of copyrighted materials:

Products can be misused by improperly copying copyrighted materials. Unless acting on the advice of a knowledgeable attorney, be responsible and respectful by obtaining the permission of the copyright holder before copying published material.

Advisories and Warnings for Using the Touchscreen

- The LCD screen may contain a few small bright or dark spots, and because of its features it may have an uneven brightness. These are normal and do not indicate that it is damaged in any way.
- Only use a dry, soft cloth for cleaning. Do not use liquid or chemical cleaners.

- The exterior cover of the touchscreen could break if it receives a heavy impact. Contact your dealer if the panel surface chips or cracks, and do not touch or attempt to remove the broken pieces.
- Press the touchscreen gently with your finger. Do not press force or operate with your nails.
- Do not use sharp objects such as ball point pens or sharp pencils to perform operations.
- Condensation inside the touchscreen due to abrupt changes in temperature or humidity may cause performance to deteriorate.

Advisories and Warnings for Connecting to the Internet

Do not connect this product to the Internet directly. Connect it in a network protected by a router or firewall.

Protecting Your Personal Information

When you give the scanner to someone else or dispose of it, erase all the personal information stored in the scanner's memory by selecting the menus on the control panel as described below.

Settings > System Administration > Restore Default Settings > All Settings

Notes on the Administrator Password

This device allows you to set an administrator password to prevent unauthorized third parties from accessing or changing the device settings or the network settings stored in the device when it is connected to a network.

If you set an administrator password, you need to enter the password when changing settings in configuration software such as Web Config.

The initial administrator password is set on the scanner, but you can change it to any password.

Initial Administrator Password

The initial administrator password varies depending on the label attached to the product. If there is a "PASSWORD" label attached to the back, enter the 8-digit number shown on the label. If there is no "PASSWORD" label attached, enter the serial number on the label attached to the back of the product for the initial administrator password.

We recommend changing the initial administrator password from the default setting.

Note:

No user name is set as default.

Operations that Require the Administrator Password

If you are prompted to enter the administrator password during the following operations, enter the administrator password set on the product.

- When logging on to the advanced settings for Web Config

- When operating a menu on the control panel that has been locked by the administrator
- When changing the device settings in the application
- When updating the firmware for the device
- When changing or resetting the administrator password

Changing the Administrator Password

You can change from the product's control panel or in Web Config.

When changing the password, the new password must be 8 to 20 characters long and only contain single-byte alphanumeric characters and symbols.

Resetting the Administrator Password

You can reset the administrator password to the initial setting from the product's control panel or in Web Config.

If you have forgotten the password and cannot reset it to the default settings, the product needs to be repaired. Contact your local dealer.

Product Features

Epson's Network Scanning Technology "ScanWay".	16
Providing Authentication Options for a Secure Scanning Environment.	16
Scanning Functions that Support High Productivity.	17
Useful Image Quality Adjustment Features.	17

Epson's Network Scanning Technology "ScanWay"

This scanner is a network scanner which has three elements, "Computerless", "Share", and "Secure".

"Computerless"

- You can send the scanned image to a selected destination (such as network folder, email, cloud service, or USB drive) by operating the scanner's touch screen.

["Scanning Using the Scanner's Control Panel" on page 77](#)

- You can also use the smart device application Epson Smart Panel to set the scanner settings, and scan and save the images to the device.

["Application for Scanning from Smart Devices \(Epson Smart Panel\)" on page 33](#)

"Share"

- This scanner comes with an easy-to-use, large size 4.3 inch touch screen.
- You can customize the screen display to suit your scanning needs. By changing the icon and colors on the screen display, you can easily find your preferred scanning setting. This feature is useful when sharing the scanner with more than one person.

["Customizing the Control Panel Display" on page 143](#)

"Secure"

This scanner provides authentication options for a secure scanning environment.

Depending on your environment, you can prepare an authentication server or use the scanner for authentication without needing a server.

["Providing Authentication Options for a Secure Scanning Environment" on page 16](#)

Providing Authentication Options for a Secure Scanning Environment

The scanner supports the following authentication options, which provide a variety of authentication methods, such as touching the scanner with an ID card. Also, to achieve a secure scanning environment, the scanning function and destination settings are displayed on the panel for each user to prevent accidental operations.

- Epson Print Admin**

You can build an authentication system using a server.

- Epson Print Admin Serverless**

You can use the authentication function built into the scanner without the need for a server.

Contact your dealer for more information.

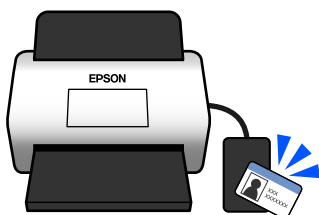

Scanning Functions that Support High Productivity

This scanner provides scanning functions that support high productivity.

Paper Protection to Reduce Damage to the Originals

This scanner comes with a paper protection feature. If the sensor detects an error, such as when scanning a document that has been stapled, it will stop scanning to prevent damage to the document that could be caused by a paper jam.



Notification of Dirt on the Glass Surface

This scanner can detect dirt on the glass surface, and notify you that you need to clean the glass surface before dirt can cause lines (streaks) in the scanned images.

You can easily keep the glass surface clean, and avoid a decline in image quality.

This feature is off by default.

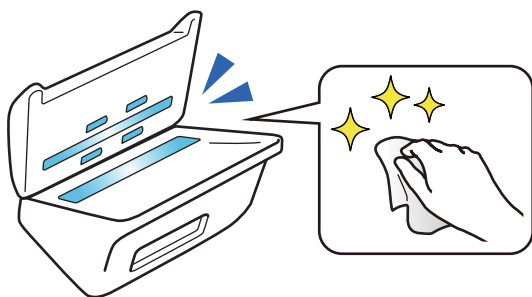

Related Information

- ➔ [“Scanner Settings” on page 152](#)
- ➔ [“Cleaning Inside the Scanner” on page 161](#)

Useful Image Quality Adjustment Features



Automatically Scan at the Optimum color

You can automatically detect the color of the original and then scan it. Even when color and black-and-white originals are mixed, they can be automatically scanned at the optimum color (Image Type).

Color original: Scan using Color.

Black-and-white originals with gradation (gray areas): Scan using Gray.

Black-and-white originals without gradation (no gray areas): Scan using B&W.

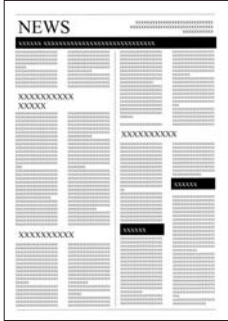
<p>Example of original</p>			
<p>Image Type to be identified</p>	<p>Color</p>	<p>Gray</p>	<p>B&W</p>

Select **Auto** as the **Image Type** in the scanner driver (Epson Scan 2).

When scanning from the control panel, select **Color/Grayscale/B&W**, **Color/Black & White**, or **Color/Grayscale** as the **Image Type**. The Image Type that can be selected differs depending on the feature used and the file format to be saved.

Note:

When using Epson Smart Panel, setting **Image Type** to **Auto** scans the image in Color or Gray.

Text Enhancement Feature

You can clearly scan text that is difficult to read due to backgrounds and other factors. You can emphasize text and remove dotted patterns in the background of the original according to the original.

You can set this on the **Advanced Settings** tab > **Text Enhancement** > **Settings** in the scanner driver (Epson Scan 2).

When scanning in Color or Gray

The following features are available.

Note:

When scanning from the control panel, you can only use the **Computer** feature.

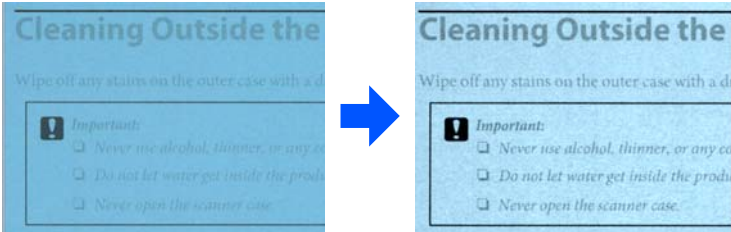
Feature	Explanation
<p>Emphasize light letters for OCR</p>	<p>You can emphasize light letters so that they can be more easily recognized by OCR. You can adjust the level of the effect.</p> <div style="text-align: center;">  </div>

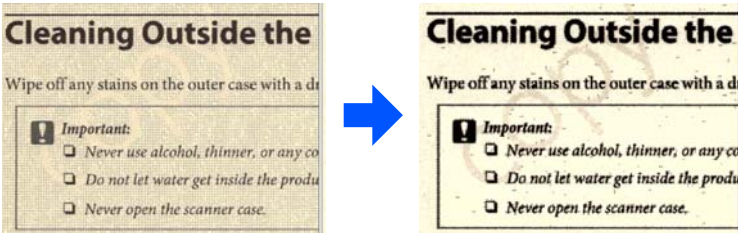
Feature	Explanation
Remove halftone dots	<p>When scanning in Color or Gray, turn this on to remove dotted patterns in the background of the original.</p> 

When scanning in B&W

The following features are available.

Note:

You can also use these when scanning from the control panel.

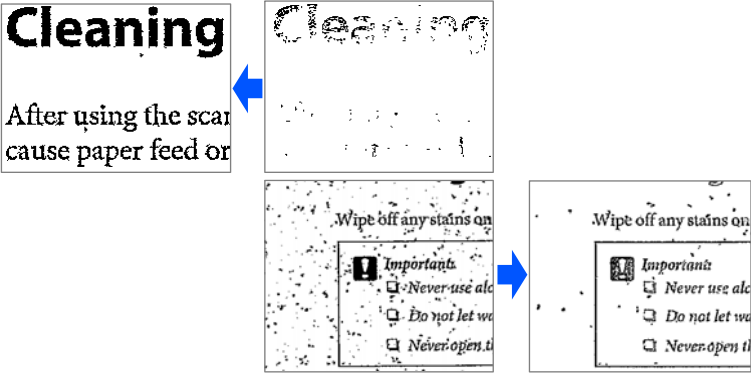
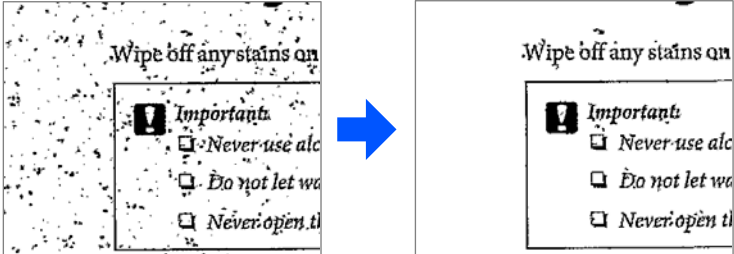
Feature	Explanation
Emphasize light letters / Remove background	<p>You can set the level of text and background correction to enhance light text, remove background colors, patterns, wrinkles, and offset.</p> 
Remove spot noise	<p>You can remove black dots in the background of the original that cannot be removed by lightening the background. You can adjust the level of the effect.</p> 

Correct folds or tears

You can correct scanned images when the corners or the edges of the original are folded or torn, or when a shadow appears around the scanned image. The missing edges or corners of the scanned image will be filled with the color of the original document.

You can set this on the **Advanced Settings** tab > **Edge Correction** > **Settings** in the scanner driver (Epson Scan 2).

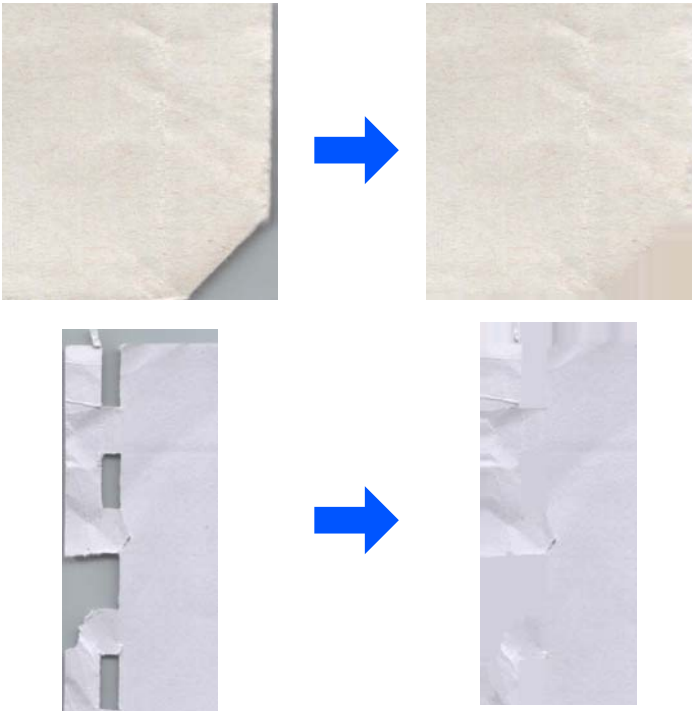

Related Information

➔ [“Software Image Quality Adjustment Features” on page 115](#)

Scanner Basics

Part Names and Functions.	22
Paper Alignment Plate.	24
Control Panel.	25
Inserting and Removing a USB Drive.	30
Information on Applications.	32
Option Items and Consumables Information.	37

Part Names and Functions

Front

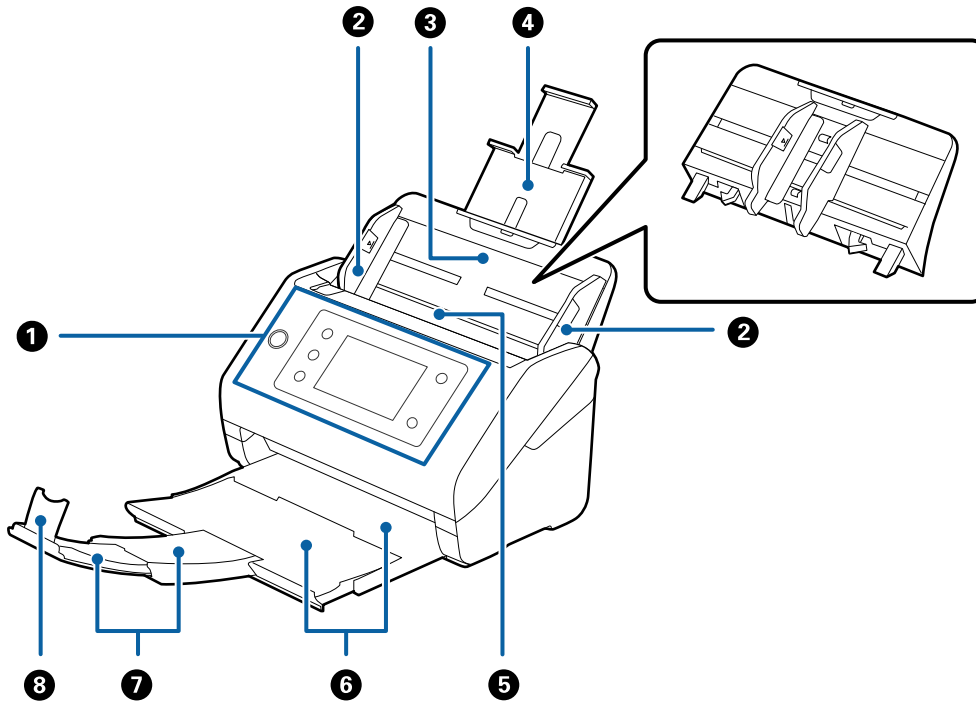

1	Control panel	Indicates the scanner's status and allows you to make scanning settings.
2	Edge guides	Feeds originals straight into the scanner. Slide to the edges of the originals.
3	Input tray	Loads originals. Pull out the tray extension if originals are too big for the input tray. This prevents paper from curling and causing paper jams. When removing the input tray, slide the hooks that are on both ends at the back, and then pull out the input tray.
4	Input tray extension	
5	ADF (Automatic Document Feeder)	Feeds loaded originals automatically.
6	Output tray	Holds originals ejected from the scanner. Pull out the output tray extension to the length of the originals.
7	Output tray extension	
8	Stopper	Prevents ejected originals from falling off the extension tray. Adjust it to the length of the originals.

Rear

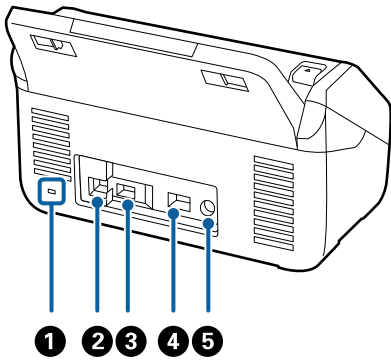

①	Security slot	Inserts a security lock for theft prevention.
②	USB port	Connects a USB cable.
③	External interface USB port	Connects a USB drive or an authentication device.
④	LAN port	Connects a LAN cable.
⑤	DC inlet	Connects the AC adapter.

Inside

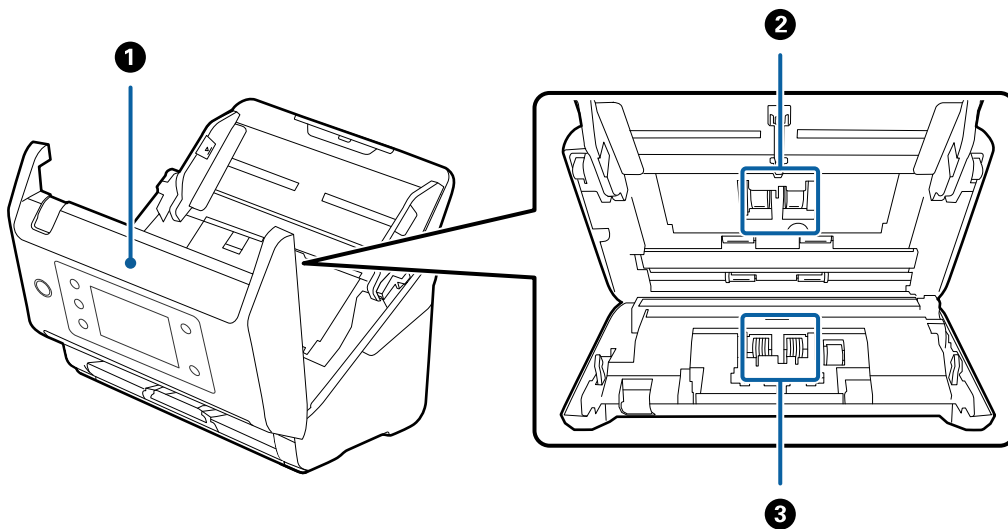

①	Scanner cover	Pull the lever and open the scanner cover when cleaning inside the scanner and removing jammed paper.
②	Pickup roller	Feeds originals. This needs to be replaced when the number of scans exceeds the service number of papers.
③	Separation roller	Feeds originals separately one by one. This needs to be replaced when the number of scans exceeds the service number of papers.

Related Information

➔ [“Cleaning Inside the Scanner” on page 161](#)

➔ “Replacing the Roller Assembly Kit” on page 166

Paper Alignment Plate

Supplied with the DS-900WN. This is also available as an optional product sold separately.

This helps to improve the alignment of ejected originals. This is useful when scanning originals that are a mixture of different sizes.

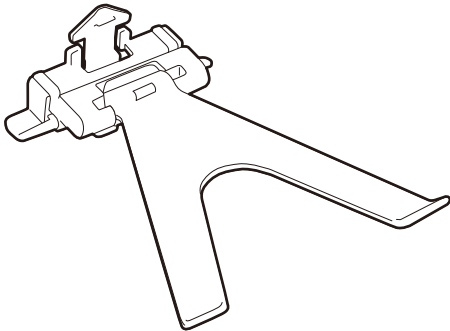

Attaching the Paper Alignment Plate

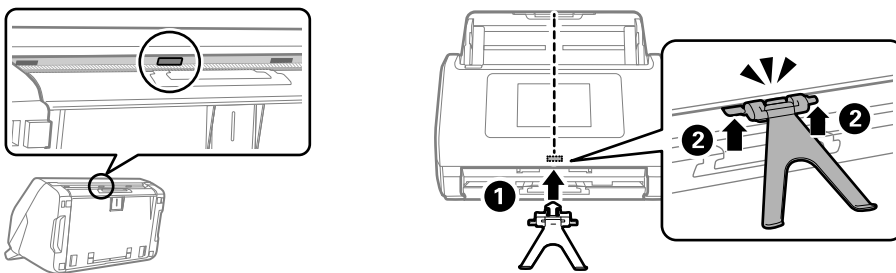

Insert the Paper Alignment Plate into the installation hole at the bottom center of the control panel (①), and then push in both sides of the plate until it clicks (②).

Note:

Raise the Paper Alignment Plate in the following situations.

- When scanning thin paper: Paper cannot be ejected correctly.
- When closing the output tray: The output tray cannot be stowed, and the Paper Alignment Plate may be damaged.

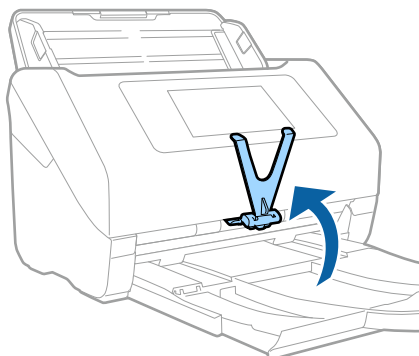

Removing the Paper Alignment Plate

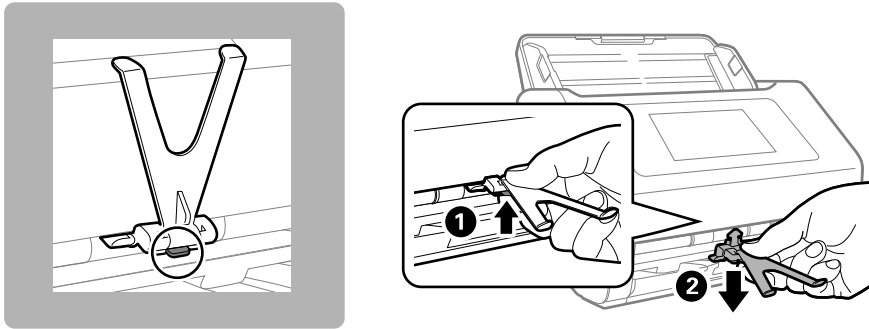







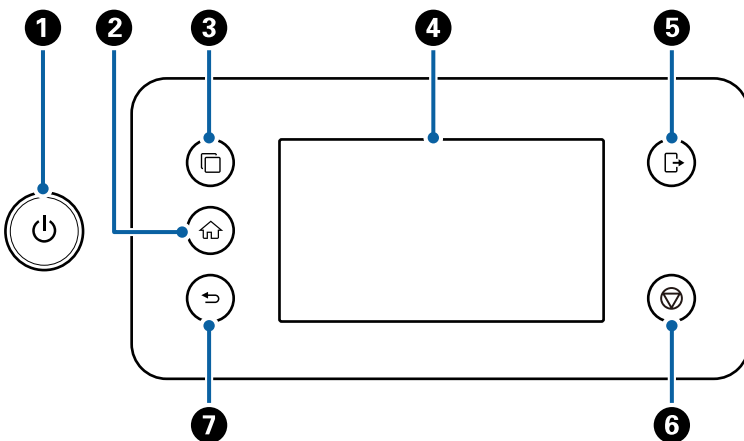

To uninstall the Paper Alignment Plate, while pushing the hook at the bottom of the plate (1), pull the plate out of the bottom (2).

Control Panel

Buttons and Lights



No.	Name	Function	When Button is Available	When Button is Not Available
1	 Power button/light	Turns the scanner on or off. Do not turn off the scanner while the light is flashing because the scanner is operating or processing a data.	-	-
2	 Home button	Displays the home screen.	When a screen other than the home screen is displayed	When the home screen is displayed (the home icon is displayed at the top left of the screen)

No	Name	Function	When Button is Available	When Button is Not Available
3	 Switch ISV server button	Switches systems when multiple synchronized systems are registered to the scanner.	When multiple synchronized systems are registered to the scanner	<input type="checkbox"/> When no synchronized systems are registered to the scanner <input type="checkbox"/> When only one synchronized system is registered to the scanner
4	LCD Screen	Tap the screen to select menus or make settings.	-	-
5	 Logout button	Logs you out if you are logged in to a scanner with Lock Setting, Access Control , or an authentication system configured.	When Lock Setting, Access Control , or an authentication system is enabled, and you are logged in to the scanner ( is displayed at the top right of the screen) "Logging in to the Scanner from the Control Panel" on page 28	When you are not logged in to the scanner
6	 Stop button	Stops the current operation.	When performing an operation such as scanning	When not performing an operation
7	 Back button	Returns to the previous screen.	When a screen other than the home screen is displayed	When the home screen is displayed ( is displayed at the top left of the screen)

Basic Screen Composition

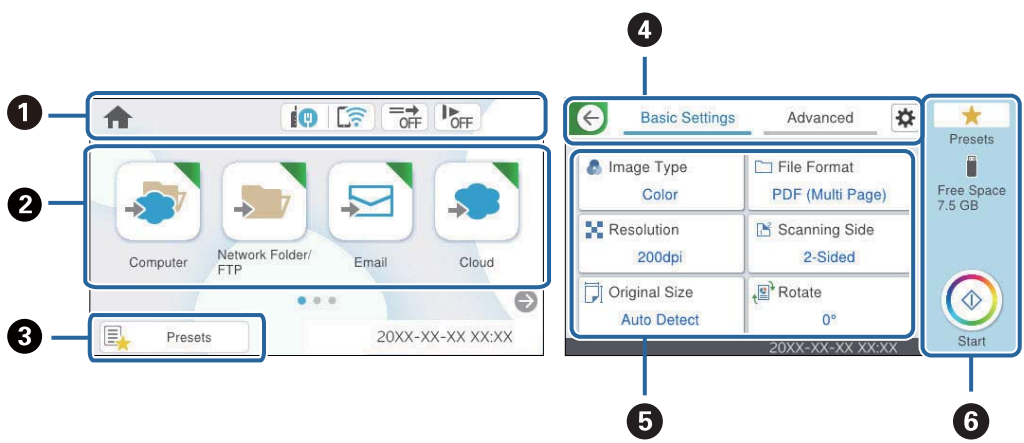



















1	Indicates the scanner status as icons. Select the icon to check the current settings or access each setting menu.
2	Displays menus. You can add menu icons and change the display order.
3	Displays the presets list. You can load your presets and register new presets.

4	Switch tabs.
5	Displays the list of setting items. Select each item to set or change the settings. Grayed out items are not available.
6	Starts scanning using current settings.

Icons Displayed on the LCD Screen

The following icons are displayed on depending on the scanner's status.

	This icon indicates that you are on the home screen.
	Displays the network connection status. Select the icon to check and change the current settings. This is the shortcut for the following menu. Settings > Network Settings > Wi-Fi Setup
	The scanner is not connected to a wired (Ethernet) network or unset it.
	The scanner is connected to a wired (Ethernet) network.
	The scanner is not connected to a wireless (Wi-Fi) network.
	The scanner is searching for SSID, unset IP address, or having a problem with a wireless (Wi-Fi) network.
	The scanner is connected to a wireless (Wi-Fi) network. The number of bars indicates the signal strength of the connection. The more bars there are, the stronger the connection.
	The scanner is not connected to a wireless (Wi-Fi) network in Wi-Fi Direct (Simple AP) mode.
	The scanner is connected to a wireless (Wi-Fi) network in Wi-Fi Direct (Simple AP) mode.
	This icon indicates whether or not the DFDS Function (Double Feed Detection Skip Function) feature is enabled. When enabled, the icon changes to  . This feature skips double feed detection once and continues scanning. Enable this to scan originals that are detected as double feeds, for example plastic cards or envelopes.
	This icon indicates whether or not the Slow feature is enabled. When enabled, the icon changes to  . This feature slows down the scanning speed. Enable this to scan originals that are likely to jam, such as thin paper.
	Indicates that the user restriction feature is enabled. Select this icon to log in to the scanner. You need to enter the password. Contact your scanner administrator for the password. When  is displayed, a user with access permission has logged in. Select the icon to logout.
	Returns to the previous screen.

	Indicates that the scan settings have been changed from the factory default or the default set in User Settings .
	Indicates that there is additional information. Select the icon to display the message.
	Indicates a problem with the items. Select the icon to check how to solve the problem. <ul style="list-style-type: none"> <input type="checkbox"/> Roller Replacement: The number of scans exceeds the life cycle of the rollers. Replace the rollers. <input type="checkbox"/> Glass Cleaning: Dirt has been detected on the glass surface inside the scanner. Clean the inside of the scanner. <input type="checkbox"/> Regular Cleaning: It is time to clean inside the scanner.

Logging in to the Scanner from the Control Panel

When **Lock Setting** or **Access Control** is enabled,  is displayed on the control panel, and the functions are restricted.



In this situation, users cannot change the scanner settings, and only some functions are available. You need to log in to use the scanner.

1. Tap  at the top right of the screen.
2. When the **Select User** screen is displayed, select the user to log in.
3. Enter the password to log in.

Note:

Contact your administrator for the user and password information.

A login complete message is displayed, and then the Home screen on the control panel is displayed.

To log out, tap  at the top right of the screen or press the  button.

Touch Screen Operations

The touchscreen is compatible with the following operations.

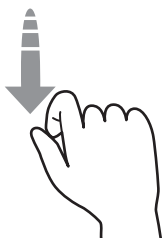
Tap		Press or select the items or the icons.
Flick		Scroll the screen swiftly.

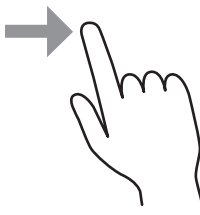
Slide		Hold and move the items around.
-------	---	---------------------------------

Entering Characters

You can enter characters and symbols by using on-screen keyboard when you register a contact, make network settings, and so on.

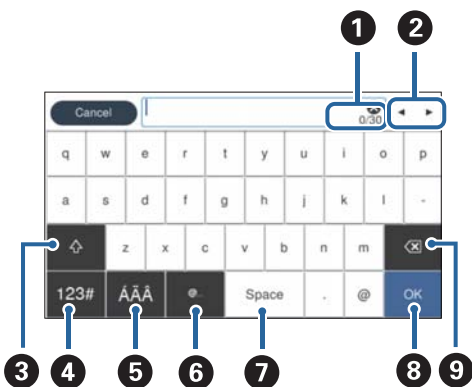

Note:

Available icons vary depending on the setting item.

1	Displays the number of characters.
2	Moves the cursor to the input position.
3	Switches between upper case and lower case or numbers and symbols.
4	Switches the character type. <div style="border: 1px solid black; padding: 2px; display: inline-block; margin: 5px;">123#</div> : You can enter numbers and symbols. <div style="border: 1px solid black; padding: 2px; display: inline-block; margin: 5px;">ABC</div> : You can enter letters.
5	Switches the character type. You can enter alphanumerics and special characters such as umlauts and accents.
6	Enters frequently used email domain addresses or URLs by simply selecting the item.
7	Enters a space.
8	Fixes the entered characters.
9	Deletes the entered characters.

Viewing Animations

You can load various kinds of originals by viewing guidance animations on the control panel.

- ❑ Select **Help** on the home screen of the control panel: Displays help screen. Select **How To** and select the items that you want to view.
- ❑ Select **How To** at the bottom of the operation screen: Displays the context-sensitive animation. Note that the animation depends on the scanner model.

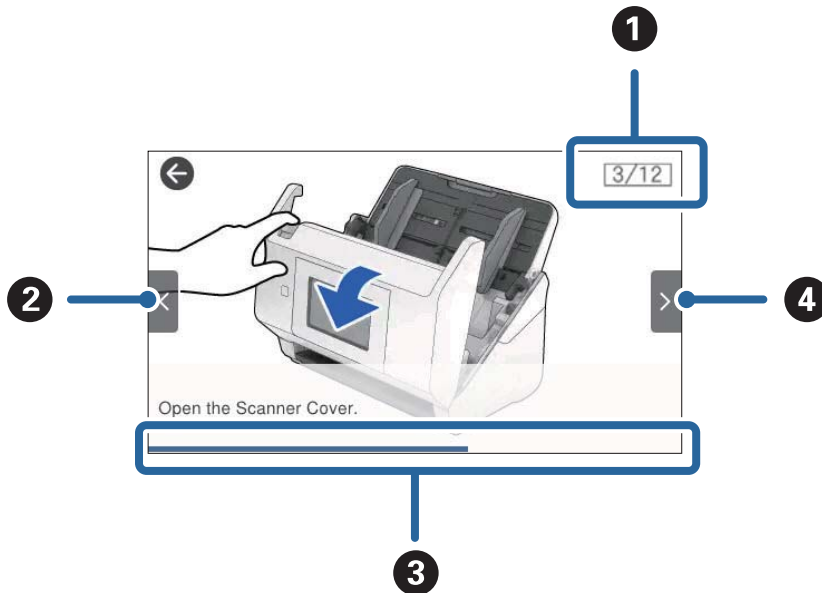

1	Indicates the total number of steps and the current step number. The example shows step 3 of 12.
2	Back to the previous step.
3	Indicates your progress through the current step. The animation repeats when the progress bar reaches the end.
4	Moves to next step.

Inserting and Removing a USB Drive

Note:

If you connect an authentication device to the external interface USB port, you cannot use the port to connect a USB drive to save the scanned image.

Inserting a USB Drive

Insert a USB drive into the external interface USB port.

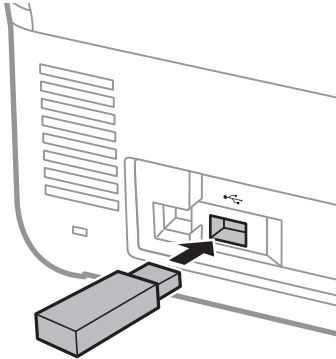

Removing a USB Drive

Remove a USB drive.

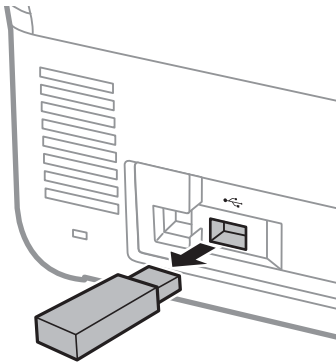

! **Important:**

- If you remove the USB drive device while transferring data to the scanner, the data on the USB drive may be lost.
- While transferring data, a message is displayed on the control panel.

Also, backup the data in external storage device to another media as necessary.

The data may be lost or corrupted in the following situations:

- When affected by static electricity or electrical noise
- When used incorrectly
- When broken or repaired
- When damaged by natural disaster

Information on Applications

This section introduces the application products available for your scanner. The latest application can be installed at the Epson Web site.

Application for Scanning Documents (Document Capture Pro / Document Capture)

Document Capture Pro* is an application that allows you to efficiently scan originals such as documents.

You can register a set of operations, such as Scan-Save-Send, as a “job”. By registering a series of operations in advance as a job, you can perform all of the operations by simply selecting the job. By assigning a job to the scanner's control panel, you can start a job from the control panel (Button Assignment).

See the Document Capture Pro help (Windows) or Document Capture (Mac OS) for details on using the application.

* This name is for Windows. For Mac OS, the name is Document Capture.

Starting on Windows

Windows 11

Click the start button, and then select **All apps > Epson Software > Document Capture Pro**.

Windows 10

Click the start button, and then select **Epson Software > Document Capture Pro**.

Windows 8.1/Windows 8

Enter the application name in the search charm, and then select the displayed icon.

Windows 7

Click the start button, and then select **All Programs > Epson Software > Document Capture Pro**.

Starting on Mac OS

Select **Go > Applications > Epson Software > Document Capture**.

Application for Controlling the Scanner (Epson Scan 2)

Epson Scan 2 is a scanner driver that allows you to control the scanner. You can adjust the size, resolution, brightness, contrast, and quality of the scanned image. You can also start this application from a TWAIN-compliant scanning application.

See the Epson Scan 2 help for details on using the application.

Starting on Windows

Note:

*For Windows Server operating systems, make sure the **Desktop Experience** feature is installed.*

Windows 11/Windows Server 2022

Click the start button, and then select **All apps > EPSON > Epson Scan 2**.

- Windows 10/Windows Server 2016/Windows Server 2019

Click the start button, and then select **EPSON > Epson Scan 2**.

- Windows 8.1/Windows 8/Windows Server 2012 R2/Windows Server 2012

Enter the application name in the search charm, and then select the displayed icon.

- Windows 7/Windows Server 2008 R2/Windows Server 2008

Click the start button, and then select **All Programs** or **Programs > EPSON > Epson Scan 2 > Epson Scan 2**.

Starting on Mac OS

Select **Go > Application > Epson Software > Epson Scan 2**.

Application for Scanning from Smart Devices (Epson Smart Panel)

Epson Smart Panel is an application that allows you to scan documents using smart devices such as smart phones and tablet devices. You can save the scanned data in smart devices or cloud services, and send by e-mail.

Even if you do not have a wireless router, you can automatically connect Wi-Fi enabled smart devices to the scanner by using Wi-Fi Direct.

You can download and install Epson Smart Panel from the App Store or Google Play.

Application for Updating Software and Firmware (EPSON Software Updater)

EPSON Software Updater is an application that installs new software, and updates firmware and manuals over the Internet. If you want to check for update information regularly, you can set the interval for checking for updates in EPSON Software Updater's auto update settings.

Note:

Windows Server operating systems are not supported.

Starting on Windows

- Windows 11

Click the start button, and then select **All apps > Epson Software > EPSON Software Updater**.

- Windows 10

Click the start button, and then select **Epson Software > EPSON Software Updater**.

- Windows 8.1/Windows 8

Enter the application name in the search charm, and then select the displayed icon.

- Windows 7

Click the start button, and then select **All Programs > Epson Software > EPSON Software Updater**.

Starting on Mac OS

Select **Go > Applications > Epson Software > EPSON Software Updater**.

Application for Configuring Scanner Operations (Web Config)

Web Config is an application that runs in web browsers, such as Microsoft Edge and Safari, on a computer or a smart device. You can confirm the scanner status or change the network service and scanner settings. To use Web Config, connect the scanner and the computer or device to the same network.

The following browsers are supported. Use the latest version.

Microsoft Edge, Windows Internet Explorer, Firefox, Chrome, Safari

Note:

You may be prompted to enter the administrator password while using this device. See the following for details on the administrator password.

[“Notes on the Administrator Password” on page 13](#)

Related Information

➔ [“Cannot Access Web Config” on page 178](#)

How to Run Web Config in a Web Browser

The scanner comes with built-in software called Web Config (a Web page where you can make settings). To access Web Config, simply enter the IP address of a network-connected scanner in your browser.

1. Check the scanner's IP address.

Select **Settings** > **Network Settings** > **Network Status** on the scanner's control panel. Then select the active connection method (**Wired LAN/Wi-Fi Status** or **Wi-Fi Direct Status**) to confirm the scanner's IP address.

Example IP address: 192.168.100.201

2. Launch a browser from a computer or a smart device, and then enter the scanner's IP address in the address bar.

Format: http://scanner's IP address/

Example: http://192.168.100.201/

If a warning screen is displayed in your browser, you can safely ignore the warning and display the Web page (Web Config). Since the scanner uses a self-signed certificate when accessing HTTPS, a warning is displayed on the browser when you start Web Config; this does not indicate a problem and can be safely ignored.

Depending on your browser, you may need to click on **Advanced Settings** to view the Web page.

Example: For Microsoft Edge

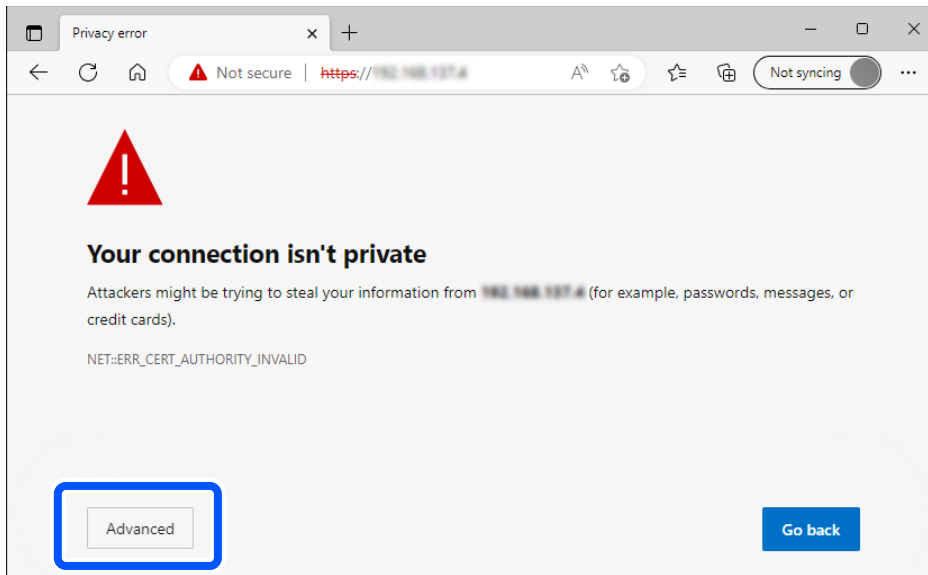

Note:

- If a warning screen is not displayed, go to the next step.
- For IPv6 addresses, use the following format.
 Format: *http://[scanner's IP address]/*
 Example: *http://[2001:db8::1000:1]/*

3. To change scanner settings, you need to log in as a Web Config administrator.

Click **Log in** at the top-right of the screen. Enter the **User Name** and **Current password**, and then click **OK**.

The following provides the initial values for the Web Config administrator information.

- User name: none (blank)
- Password: Depends on the label attached to product.

If there is a "PASSWORD" label attached to the back, enter the 8-digit number shown on the label. If there is no "PASSWORD" label attached, enter the serial number on the label attached to the back of the product for the initial administrator password.

Note:

- If **Log out** is displayed at the top-right of the screen, you are already logged in as an administrator.
- You will be logged out automatically after approximately 20 minutes of inactivity.

Application for Setting up the Device on a Network (EpsonNet Config)

EpsonNet Config is an application that allows you to set network interface addresses and protocols. See the operations guide for EpsonNet Config or the application's help for more details.

Starting on Windows

- Windows 11/Windows Server 2022

Click the start button, and then select **All apps > EpsonNet > EpsonNet Config**.

- ❑ Windows 10/Windows Server 2019/Windows Server 2016

Click the start button, and then select **EpsonNet > EpsonNet Config**.

- ❑ Windows 8.1/Windows 8/Windows Server 2012 R2/Windows Server 2012

Enter the application name in the search charm, and then select the displayed icon.

- ❑ Windows 7/Windows Vista/Windows Server 2008 R2/Windows Server 2008/Windows Server 2003 R2/Windows Server 2003

Click the start button, and select **All Programs** or **Programs > EpsonNet > EpsonNet Config SE > EpsonNet Config**.

Starting on Mac OS

Go > **Applications > Epson Software > EpsonNet > EpsonNet Config SE > EpsonNet Config**.

Software for Managing Devices on the Network (Epson Device Admin)

Epson Device Admin is a multifunctional application software that manages the device on the network.

The following functions are available.

- ❑ Monitor or manage up to 2,000 printers or scanners over the segment
- ❑ Make a detailed report, such as for the consumable or product status
- ❑ Update the firmware of the product
- ❑ Introduce the device to the network
- ❑ Apply the unified settings to multiple devices.

You can download Epson Device Admin from Epson support website. For more information, see the documentation or help of Epson Device Admin.

Application for Creating Driver Packages (EpsonNet SetupManager)

EpsonNet SetupManager is a software to create a package for a simple scanner installation, such as installing the scanner driver and so on. This software allows the administrator to create unique software packages and distribute them among groups.

For more information, visit your regional Epson website.

<http://www.epson.com>

Software that uses a Server for Authenticated Scanning (Epson Print Admin)

This option allows you to build an authentication system using a server for authentication. A variety of authentication methods are available such as touching the scanner with an ID card.

To achieve a secure scanning environment, the scanning function and destination settings are displayed on the panel for each user to prevent accidental operations, and a usage log management function is used.

Contact your dealer for more information.

Option to Extend Scanning Functionality (EPA Advanced Workflows)

You can add scan settings using the EPA Advanced Workflows option.

- Extending scan setting items
- Sorting scan results
- Extending scan destinations
- Outputting information when scanning

Software that does not use a Server for Authenticated Scanning (Epson Print Admin Serverless)

This option allows you to use the authentication function built into the scanner without the need for a server. A variety of authentication methods are available such as touching the scanner with an ID card.

To achieve a secure scanning environment, the scanning function and destination settings are displayed on the panel for each user to prevent accidental operations.

Contact your dealer for more information.

Option Items and Consumables Information

Carrier Sheet Codes

Using a Carrier Sheet allows you to scan irregular shaped originals or photos that can be easily scratched. You can scan originals larger than A4 size with a carrier sheet by folding it in half.

Part name	Codes *1	Replacement cycle
Carrier Sheet	B12B819051	3,000*2

*1 You can only use the carrier sheet with the code.

*2 This number is a guide to the replacement cycle. Do not use a Carrier Sheet that is scratched.

Note:

*You can only use the Carrier Sheet when scanning from a computer, or when scanning from the scanner's control panel using the **Computer** feature.*

You cannot use a Carrier Sheet when scanning from the scanner's control panel using the following features:

- Network Folder/FTP
- Email
- Cloud
- USB Drive
- WSD
- Scan to My Email (When using Epson Print Admin/Epson Print Admin Serverless)
- Scan to My Folder (When using Epson Print Admin/Epson Print Admin Serverless)
- Preset scan (When using Epson Print Admin)

Related Information

- ➔ [“General Specifications for Originals being Scanned” on page 41](#)
- ➔ [“Placing Large Size Originals” on page 61](#)
- ➔ [“Placing Irregular Shaped Originals” on page 64](#)
- ➔ [“Placing Photographs” on page 67](#)

Roller Assembly Kit Codes

Parts (the pickup roller and separation roller) should be replaced when the number of scans exceeds the service number. You can check the latest number of scans on the control panel or in the Epson Scan 2 Utility.

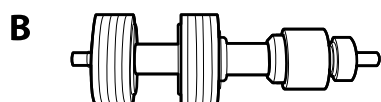
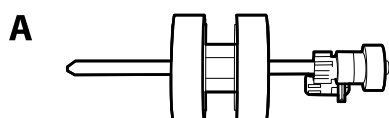

A: pickup roller, B: separation roller

Part name	Codes	Life cycle
Roller Assembly Kit 2	B12B819711 B12B819721 (India only)	200,000*

* This number was reached by consecutively scanning using Epson test original papers, and is a guide to the replacement cycle. The replacement cycle may vary depending on different paper types, such as paper that generates a lot of paper dust or paper with a rough surface that may shorten the life cycle.

Related Information

- ➔ [“Replacing the Roller Assembly Kit” on page 166](#)
- ➔ [“Resetting the Number of Scans After Replacing the Rollers” on page 171](#)

Paper Alignment Plate Codes

This helps to improve the alignment of ejected originals. This is useful when scanning originals that are a mixture of different sizes.

Note:

One is supplied with the DS-900WN.

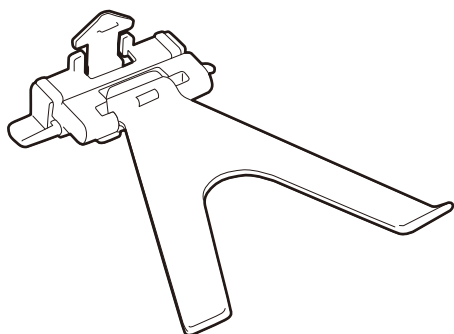

Part Name	Codes
Paper alignment plate	B12B819691 B12B819701 (India only)

Note:

Raise the Paper Alignment Plate in the following situations.

- When scanning thin paper: Paper cannot be ejected correctly.
- When closing the output tray: The output tray cannot be stowed, and the Paper Alignment Plate may be damaged.

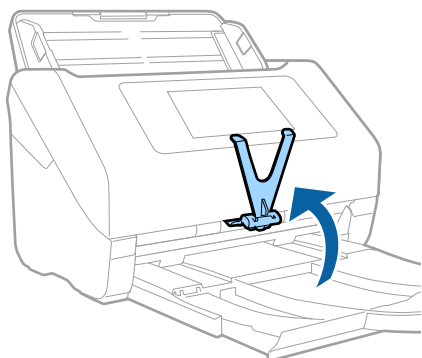

Cleaning Kit Codes

Use this when cleaning inside the scanner. This kit is composed of cleaning liquid and a cleaning cloth.

Part name	Codes
Cleaning Kit	B12B819291

Related Information

➔ [“Cleaning Inside the Scanner” on page 161](#)

Specifications and Placing of Originals

Specifications for Originals that can be Scanned.	41
Placing Originals.	47

Specifications for Originals that can be Scanned

This section explains the specifications and conditions of originals that can be loaded in the ADF.

General Specifications for Originals being Scanned

Type of Original	Thickness	Size
Plain paper	27 to 413 g/m ²	Maximum: 215.9×6,096.0 mm (8.5×240.0 in.)
Fine paper	A8 size or less: 127 to 413 g/m ²	Minimum: 50.8×50.8 mm (2.0×2.0 in.)
Recycled paper	Plastic cards: 1.24 mm (0.05 in.) or less (including emboss)	The loadable size varies depending on the type of the originals, the scanning resolution, and the scanning method.
Post card	Laminated Cards: 0.8 mm (0.03 in.) or less	
Business card		
Envelopes		
Plastic cards complying with ISO7810 ID-1 type (with or without emboss)		
Laminated cards		
Thermal paper		

Note:

- ❑ All originals must be flat at the leading edge.
- ❑ Make sure that curls on the leading edge of the originals are kept within the following range.
 - ① must be 3 mm or less.
 - ② must be 1 mm or less while ② is equal to or less than ③. When ③ is equal to or more than 10 times the size of ②, ② can be more than 1 mm.

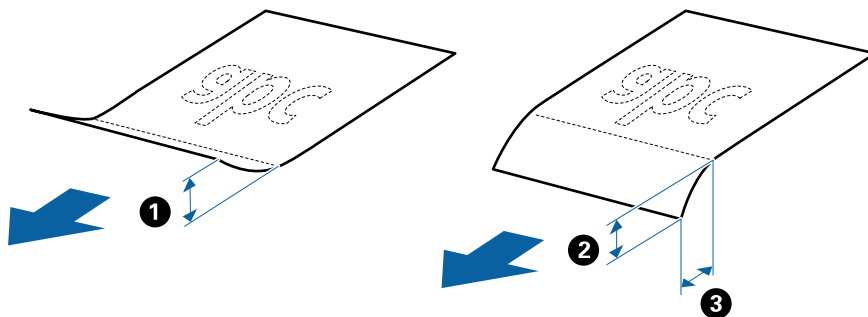

- ❑ Even when the original meets the specifications for originals that can be placed in the ADF, it may not feed from the ADF or the scan quality may decline depending on the paper properties or quality.

Specifications of Standard Size Originals

The list of the standard size originals you can load on the scanner.

Size	Measurement	Thickness	Paper Type	Loading Capacity *
Legal	215.9×355.6 mm (8.5×14 in.)	27 to 413 g/m ²	Plain paper Fine paper Recycled paper	Thickness of the originals stack: under 12 mm (0.47 in.) 80 g/m ² : 80 sheets 90 g/m ² : 69 sheets 104 g/m ² : 59 sheets 127 g/m ² : 50 sheets 157 g/m ² : 40 sheets 209 g/m ² : 30 sheets 256 g/m ² : 24 sheets 413 g/m ² : 14 sheets The loading capacity varies depending on the paper type.
Letter	215.9×279.4 mm (8.5×11 in.)			Thickness of the originals stack: under 12 mm (0.47 in.)
A4	210×297 mm (8.3×11.7 in.)			80 g/m ² : 100 sheets 90 g/m ² : 86 sheets 104 g/m ² : 74 sheets
B5	182×257 mm (7.2×10.1 in.)			127 g/m ² : 62 sheets 157 g/m ² : 50 sheets
A5	148×210 mm (5.8×8.3 in.)			209 g/m ² : 38 sheets 256 g/m ² : 30 sheets
B6	128×182 mm (5.0×7.2 in.)			413 g/m ² : 18 sheets
A6	105×148 mm (4.1×5.8 in.)			The loading capacity varies depending on the paper type.
A8	52×74 mm (2.1×2.9 in.)	127 to 413 g/m ²		
Business Card	55×89 mm (2.1×3.4 in.)	210 g/m ²		Thickness of the originals stack: under 12 mm (0.47 in.) 30 sheets

* You can refill the originals up to the maximum capacity during scanning.

Specifications of Long Paper

The specification of long paper you can load into the scanner.

Note:

- Long paper means originals with a length of 393.8 mm (15.5 in.) or more.
- When scanning long paper, scanning speed is reduced.

Size	Thickness	Paper Type	Loading Capacity
Maximum width: 215.9 mm (8.5 in.) Maximum length: 6,096.0 mm (240.0 in.)*	50 to 130 g/m ²	Plain paper Fine paper Recycled paper	1 sheet

Maximum Length for Long Paper

The following shows the maximum length according to the scanning resolution and the scanning method.

Scanning Method	Scanning Resolution	Maximum Length
<input type="checkbox"/> Scanning from a computer <input type="checkbox"/> Scanning from the scanner's control panel using the Computer feature	50 to 200 dpi	6,096.0 mm (240.0 in.)
	201 to 300 dpi	5,461.0 mm (215.0 in.)
	301 to 600 dpi	1,346.0 mm (53.0 in.)
Scanning from the scanner's control panel using the following features: <input type="checkbox"/> Network Folder/FTP <input type="checkbox"/> Email <input type="checkbox"/> Cloud <input type="checkbox"/> USB Drive <input type="checkbox"/> Scan to My Email* <input type="checkbox"/> Scan to My Folder*	200 dpi	914.4 mm (36.0 in.)
	300 dpi	
	600 dpi	Long paper is not supported
Scanning from the scanner's control panel using the WSD feature	100 dpi 300 dpi	Long paper is not supported
Scan with Epson Smart Panel	200 dpi 300 dpi 600 dpi	Long paper is not supported

* When using Epson Print Admin/Epson Print Admin Serverless

Note:

You cannot scan long paper using Epson Smart Panel.

Specifications of Plastic Cards

The specification of plastic card you can load into the scanner.

Size	Card Type	Thickness	Loading Capacity	Loading Direction
ISO7810 ID-1 Type 54.0×85.6 mm (2.1×3.3 in.)	With embossing	1.24 mm (0.05 in.) or less	1 card	Horizontal (Landscape)
	Without embossing	0.76 mm (0.03 in.) to 1.1 mm (0.04 in.) *	5 cards	
		Less than 0.76 mm (0.03 in.)	5 cards	

* You can scan these cards only when the resolution is 300 dpi or less, and disabling **Slow** mode.

Specifications of Laminated Cards

The specification of laminated cards you can load into the scanner.

Size	Thickness	Loading Capacity
120.0×150.0 mm (4.7×5.9 in.) or less	0.8 mm (0.03 in.) or less	1 card

Note:

You cannot scan laminated cards using Epson Smart Panel.

Specifications for Originals Using the Carrier Sheet

The optional Carrier Sheet is a sheet designed to transport originals through the scanner. You can scan originals that are larger than A4/Letter size, important documents or photos which must not be damaged, thin paper, irregular shaped originals, and so on.

The following table provides the conditions for using the Carrier Sheet.

Type	Size	Thickness	Loading Capacity of the Carrier Sheet
Originals that cannot be loaded directly into the scanner	A3* ¹ A4 B4* ¹ Letter Legal* ¹ B5 A5 B6 A6 A8 Custom size: <input type="checkbox"/> Width: up to 431.8 mm (17 in.) * ² <input type="checkbox"/> Length: up to 297 mm (11.7 in.) * ³	0.3 mm (0.012 in.) or less (excluding the thickness of the Carrier Sheet)	10 sheets

*1 Fold in half to set.

*2 Originals that are wider than 215.9 mm (8.5 in.) need to be folded in half.

*3 The leading edge of the original must be placed at the binding part of the Carrier Sheet when scanning an original approximately 297 mm (11.7 in.) long. Otherwise, the length of the scanned image may be longer than intended as the scanner scans to the end of the Carrier Sheet when you select **Auto Detect** as the **Document Size** setting in the application.

Note:

You cannot scan originals using the Carrier Sheet using Epson Smart Panel on smart device.

Related Information

➔ [“Carrier Sheet Codes” on page 37](#)

Specifications of Envelopes

The specification of envelopes you can load into the scanner.

Size	Measurement	Thickness	Loading Capacity
C6	114×162 mm (4.49×6.38 in.) (standard size)	0.38 mm (0.015 in.) or less	10 envelopes
DL	110×220 mm (4.33×8.66 in.) (standard size)		

Types of Originals that Require Attention

The following types of originals may not be successfully scanned.

- Originals with an uneven surface such as letter head paper.
- Originals with wrinkles or fold lines
- Perforated originals
- Original with labels or stickers
- Carbon-less paper
- Curled originals
- Coated paper

Important:

Carbon-less paper contains chemical substances that may harm the rollers. If you scan carbon-less paper, clean the pickup roller and the separation roller regularly. Also, scanning carbon-less paper may shorten the life cycle of the rollers faster than scanning plain paper.

Note:

- Crinkled originals may scan better if you slow down the feeding speed during scanning or smooth out the crinkles before loading.*
- To scan delicate originals or originals that are easily crinkled, use the Carrier Sheet (sold separately).*
- To scan originals that are incorrectly detected as double feeds, set the **DFDS Function** (Double Feed Detection Skip Function) to **On** on the control panel before you resume scanning, or select **Off** in **Detect Double Feed** on the **Main Settings** tab in the Epson Scan 2 window.
*When you are using Document Capture Pro, you can open the window by pressing the **Detailed Settings** button on the **Scan Settings** screen.**
- Labels or stickers must be firmly stuck to the originals with no glue protruding.*
- Try to flatten the curled originals before scanning.*

Related Information

- ➔ [“Scanner Basics” on page 21](#)
- ➔ [“Maintenance” on page 160](#)

Types of Originals that Must Not be Scanned

The following types of originals must not be scanned.

- Photos
- Booklets
- Bank books
- Passports
- Non-paper original (such as clear files, fabric, and metal foil)
- Originals with staples or paper clips
- Originals with glue attached

- Ripped originals
- Heavily wrinkled or curled originals
- Transparent originals such as OHP film
- Originals with carbon paper on the back
- Originals with wet ink
- Originals with sticky notes attached

Note:

- Do not feed valuable original artwork, or important documents which you do not want to damage or deface into the scanner directly. Misfeeding may wrinkle or damage the original. When scanning such originals, make sure you use the Carrier Sheet (sold separately).*
- Photos, rippled, wrinkled, or curled originals can also be scanned if you use the Carrier Sheet (sold separately).*

Related Information

- ➔ [“Photographs” on page 67](#)

Placing Originals

Standard Size Originals

Specifications of Standard Size Originals

The list of the standard size originals you can load on the scanner.

Size	Measurement	Thickness	Paper Type	Loading Capacity *
Legal	215.9×355.6 mm (8.5×14 in.)	27 to 413 g/m ²	Plain paper Fine paper Recycled paper	Thickness of the originals stack: under 12 mm (0.47 in.) 80 g/m ² : 80 sheets 90 g/m ² : 69 sheets 104 g/m ² : 59 sheets 127 g/m ² : 50 sheets 157 g/m ² : 40 sheets 209 g/m ² : 30 sheets 256 g/m ² : 24 sheets 413 g/m ² : 14 sheets The loading capacity varies depending on the paper type.
Letter	215.9×279.4 mm (8.5×11 in.)			Thickness of the originals stack: under 12 mm (0.47 in.)
A4	210×297 mm (8.3×11.7 in.)			80 g/m ² : 100 sheets 90 g/m ² : 86 sheets 104 g/m ² : 74 sheets
B5	182×257 mm (7.2×10.1 in.)			127 g/m ² : 62 sheets 157 g/m ² : 50 sheets
A5	148×210 mm (5.8×8.3 in.)			209 g/m ² : 38 sheets 256 g/m ² : 30 sheets
B6	128×182 mm (5.0×7.2 in.)			413 g/m ² : 18 sheets The loading capacity varies depending on the paper type.
A6	105×148 mm (4.1×5.8 in.)			
A8	52×74 mm (2.1×2.9 in.)	127 to 413 g/m ²		
Business Card	55×89 mm (2.1×3.4 in.)	210 g/m ²		Thickness of the originals stack: under 12 mm (0.47 in.) 30 sheets

* You can refill the originals up to the maximum capacity during scanning.

Placing Standard Size Originals

1. Extend the input tray extension. Slide out the output tray, extend the output tray extension, and then raise the stopper.

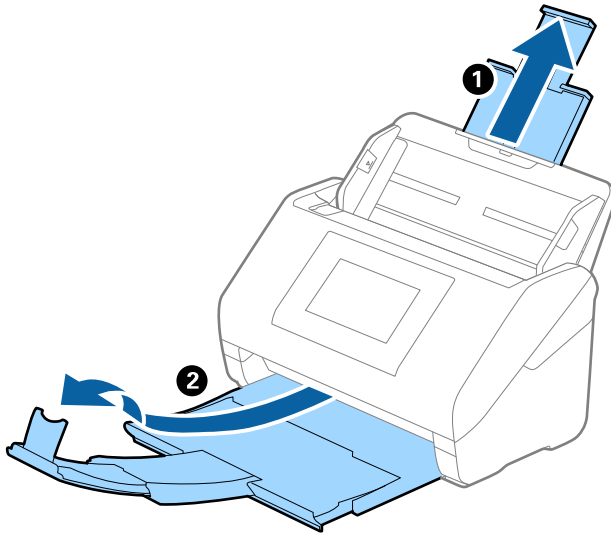

Note:

- ❑ For A4 size or larger originals, make sure you pull out and extend the input tray extension.
- ❑ Make sure you pull out and extend the output tray extensions so that they are a little bit longer than the length of the original, and raise the stopper so that the ejected originals can be stacked comfortably on the output tray.

When loading A4 size originals, extend the output tray as shown in the following image.

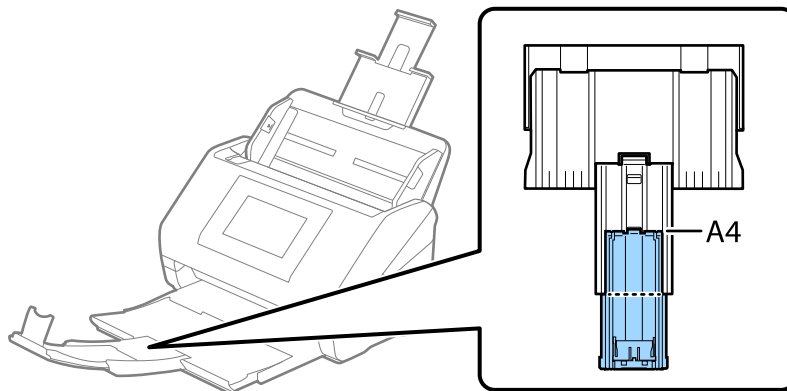

- ❑ The stopper can move forward and backward on the output tray extension so that you can easily adjust the stopper position to the best position for the originals being scanned.
- ❑ If thick originals bump into the output tray and fall from it, store the output tray and do not use it to stack the ejected originals.
- ❑ If scanned images are still affected by ejected originals hitting the surface below the scanner, we recommend placing the scanner on the edge of a table where the ejected originals can drop freely and you can catch them.

- Slide the edge guides on the input tray all the way out.

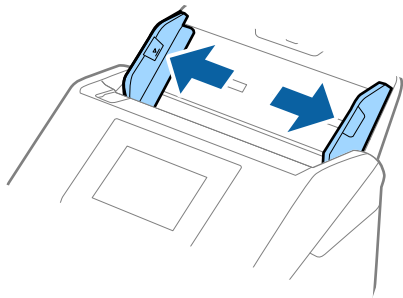

- Fan the originals.
Hold both ends of the originals and fan them a few times.

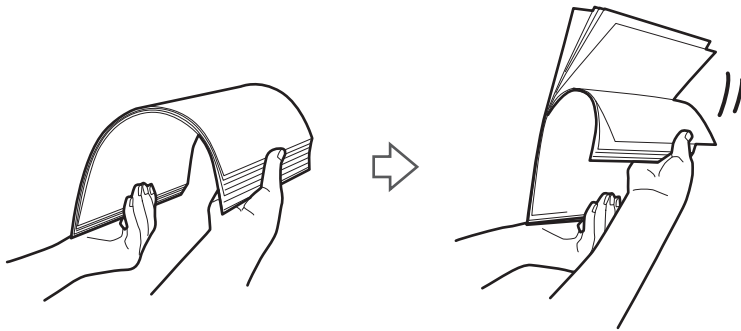

- Align the edges of the originals with the printed side facing down and slide the leading edge into a wedge shape.

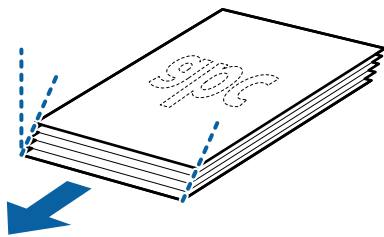

5. Load the originals into the input tray facing down with the top edge facing into the ADF. Slide the originals into the ADF until they meet resistance.

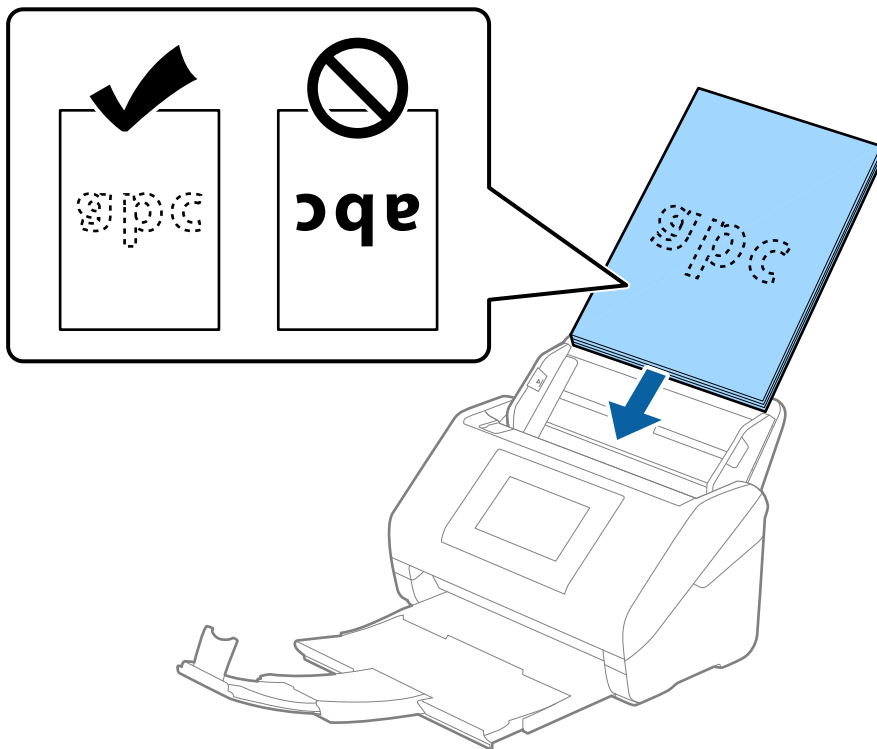

6. Slide the edge guides to fit the edge of the originals making sure there are no gaps between the originals and the edge guides. Otherwise, the originals may be fed skewed.

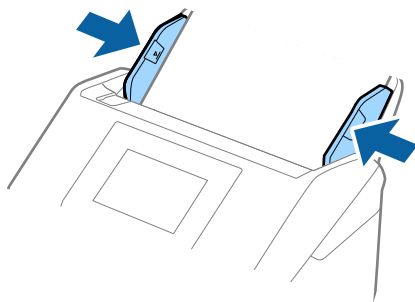

Note:

- ❑ When scanning originals with punch holes such as loose leaf paper, load the originals with the holes facing to the side or facing down. There must not be any holes within a 30 mm (1.2 inches) strip at the center of the originals. However, there can be holes within 30 mm (1.2 inches) from the leading edge of the originals. Make sure that the edges of the punch holes do not have burrs or curls.

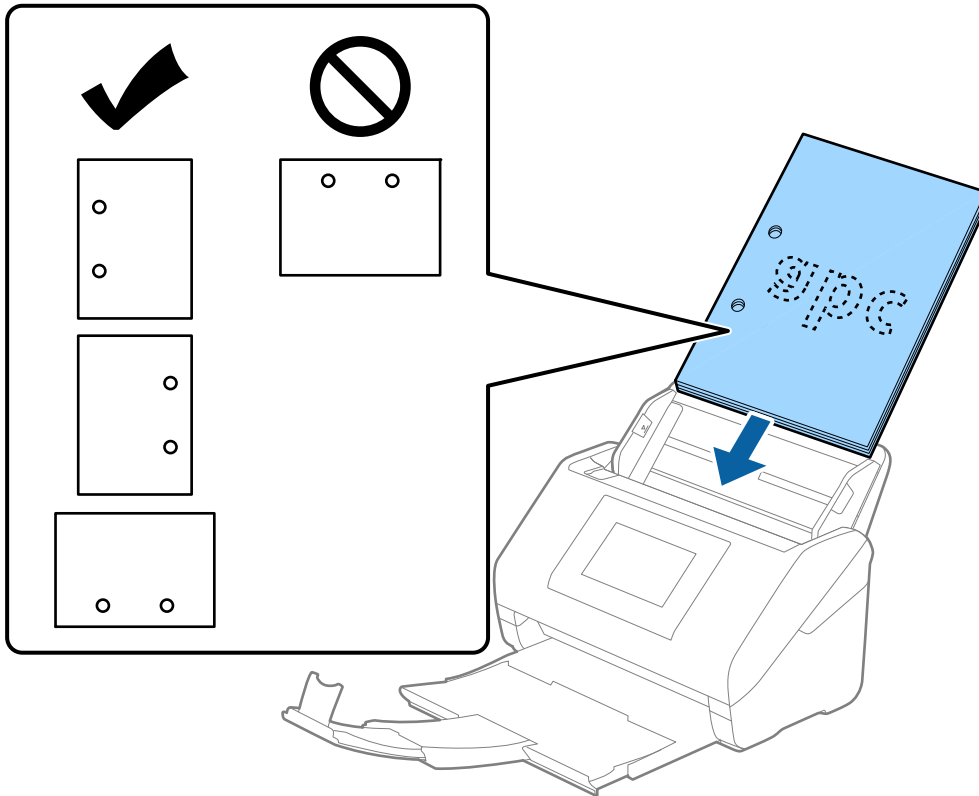

- ❑ When scanning thin paper with crinkles that are causing paper jams or double feeds, you may be able to improve the situation by enabling **Slow**. To do this, select **Settings > Scanner Settings > Slow** on the control panel and set it to **On** to slow down the feeding speed.

Long Paper

Specifications of Long Paper

The specification of long paper you can load into the scanner.

Note:

- ❑ Long paper means originals with a length of 393.8 mm (15.5 in.) or more.
- ❑ When scanning long paper, scanning speed is reduced.

Size	Thickness	Paper Type	Loading Capacity
Maximum width: 215.9 mm (8.5 in.) Maximum length: 6,096.0 mm (240.0 in.)*	50 to 130 g/m ²	Plain paper Fine paper Recycled paper	1 sheet

Maximum Length for Long Paper

The following shows the maximum length according to the scanning resolution and the scanning method.

Scanning Method	Scanning Resolution	Maximum Length
<input type="checkbox"/> Scanning from a computer <input type="checkbox"/> Scanning from the scanner's control panel using the Computer feature	50 to 200 dpi	6,096.0 mm (240.0 in.)
	201 to 300 dpi	5,461.0 mm (215.0 in.)
	301 to 600 dpi	1,346.0 mm (53.0 in.)
Scanning from the scanner's control panel using the following features: <input type="checkbox"/> Network Folder/FTP <input type="checkbox"/> Email <input type="checkbox"/> Cloud <input type="checkbox"/> USB Drive <input type="checkbox"/> Scan to My Email* <input type="checkbox"/> Scan to My Folder*	200 dpi	914.4 mm (36.0 in.)
	300 dpi	
	600 dpi	Long paper is not supported
Scanning from the scanner's control panel using the WSD feature	100 dpi 300 dpi	Long paper is not supported
Scan with Epson Smart Panel	200 dpi 300 dpi 600 dpi	Long paper is not supported

* When using Epson Print Admin/Epson Print Admin Serverless

Note:

You cannot scan long paper using Epson Smart Panel.

Placing Long Paper

1. Slide out the output tray.

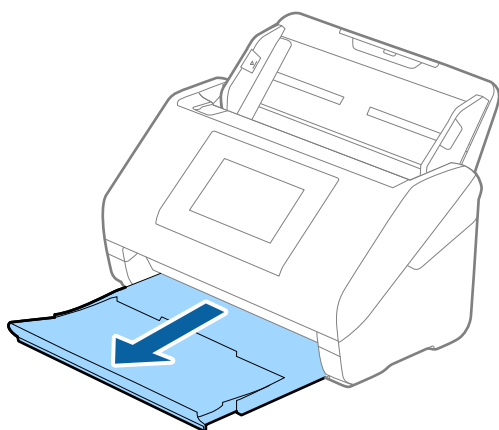

Note:

Do not extend the input tray extension and output tray extensions and do not raise the stopper.

- Slide the edge guides on the input tray all the way out.

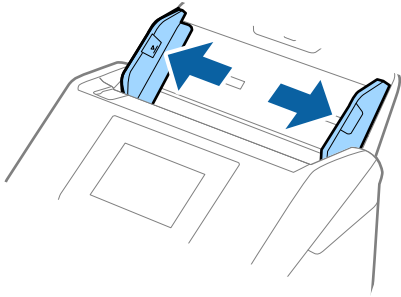

- Load the original straight into the input tray, facing down with the top edge facing into the ADF. Slide the original into the ADF until it meets resistance.

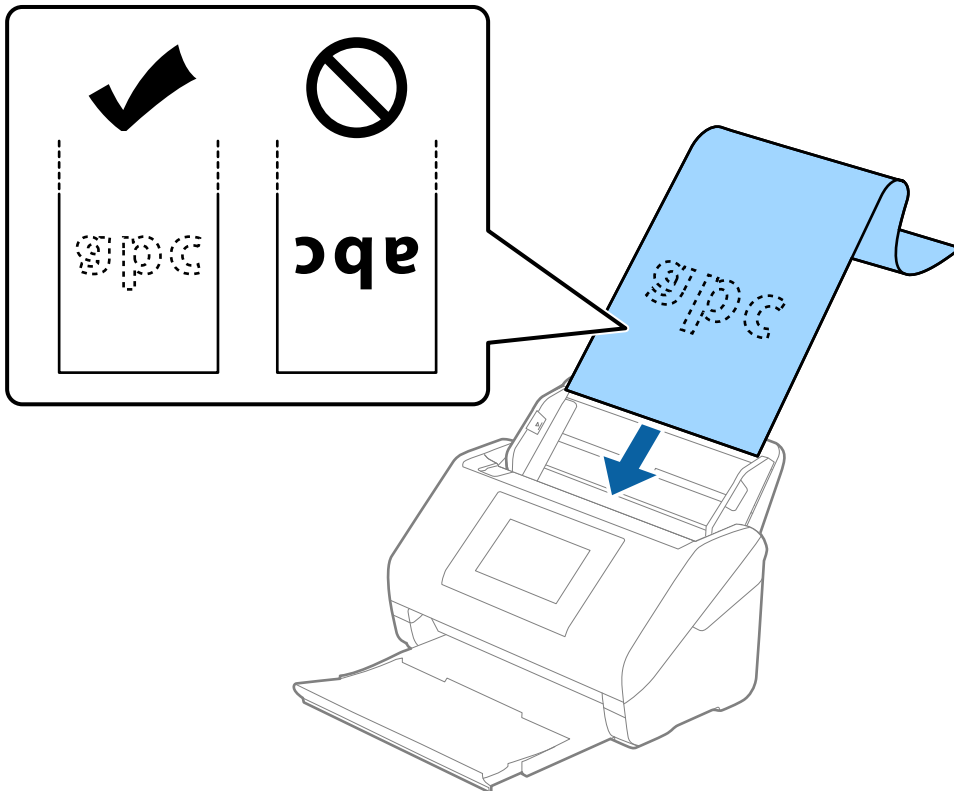

4. Adjust the edge guides to fit the edge of the long paper making sure there are no gaps between the edge of the paper and the edge guides. Otherwise, the originals may be fed skewed.

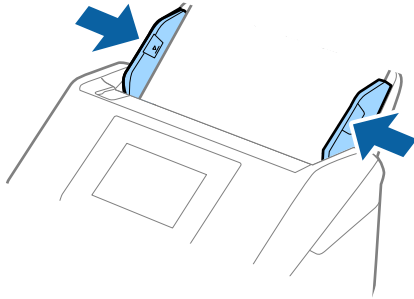

Note:

- ❑ See the following for the maximum lengths depending on the situation.

“Maximum Length for Long Paper” on page 43

- ❑ You need to specify the paper size in the Epson Scan 2 window.

*When you are using Document Capture Pro, you can open the window by pressing the **Detailed Settings** button on the **Scan Settings** screen.*

There are three ways to specify the paper size in the Epson Scan 2 window.

*If the paper length is 3,048 mm (120 inches) or less, you can select **Auto Detect (Long Paper)** to detect the size automatically.*

*If the paper length is more than 3,048 mm (120 inches), you need to select **Customize** and enter the size of the paper.*

*If the paper length is 5,461 mm (215 inches) or less, you can use **Detect paper length** instead of entering the paper height. If the paper is longer than 5,461 mm (215 inches), you need to enter the width and height of the paper.*

- ❑ Support long paper at the input side so that it does not drop out of the ADF, and on the output side so that the ejected paper does not fall from the output tray.

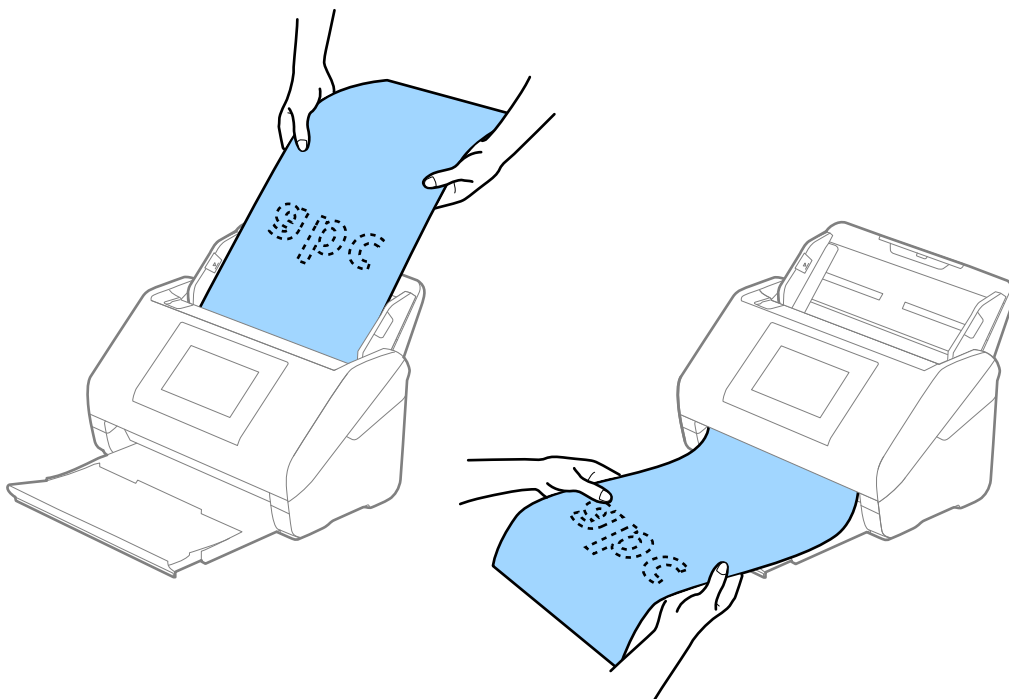

Related Information

➔ [“Required Settings for Special Originals in Epson Scan 2 Window” on page 113](#)

Plastic Cards

Specifications of Plastic Cards

The specification of plastic card you can load into the scanner.

Size	Card Type	Thickness	Loading Capacity	Loading Direction
ISO7810 ID-1 Type 54.0×85.6 mm (2.1×3.3 in.)	With embossing	1.24 mm (0.05 in.) or less	1 card	Horizontal (Landscape)
	Without embossing	0.76 mm (0.03 in.) to 1.1 mm (0.04 in.) *	5 cards	
		Less than 0.76 mm (0.03 in.)	5 cards	

* You can scan these cards only when the resolution is 300 dpi or less, and disabling **Slow** mode.

Placing Plastic Cards

1. Slide out the output tray and raise the stopper.

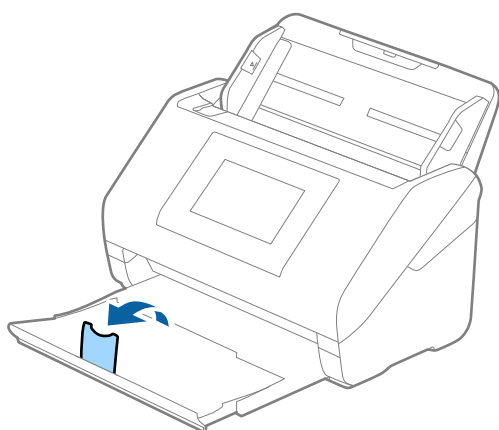

2. Slide the edge guides on the input tray all the way out.

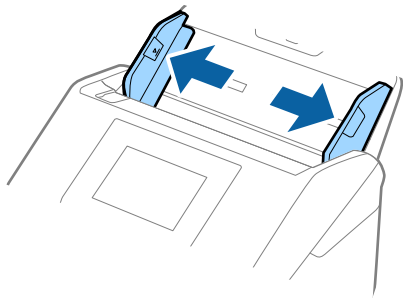

3. Load the plastic cards into the input tray facing down with the top edge facing into the ADF. Slide the plastic cards into the ADF until they meet resistance.

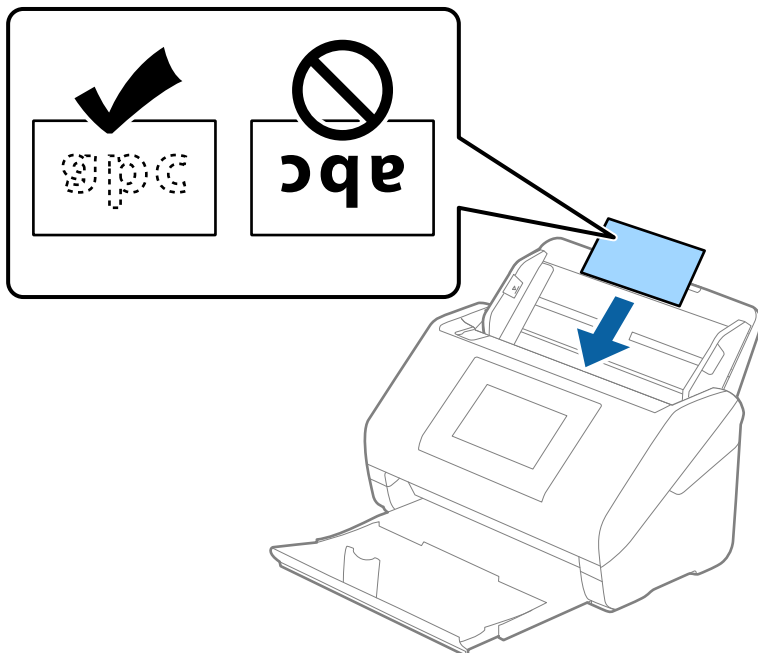

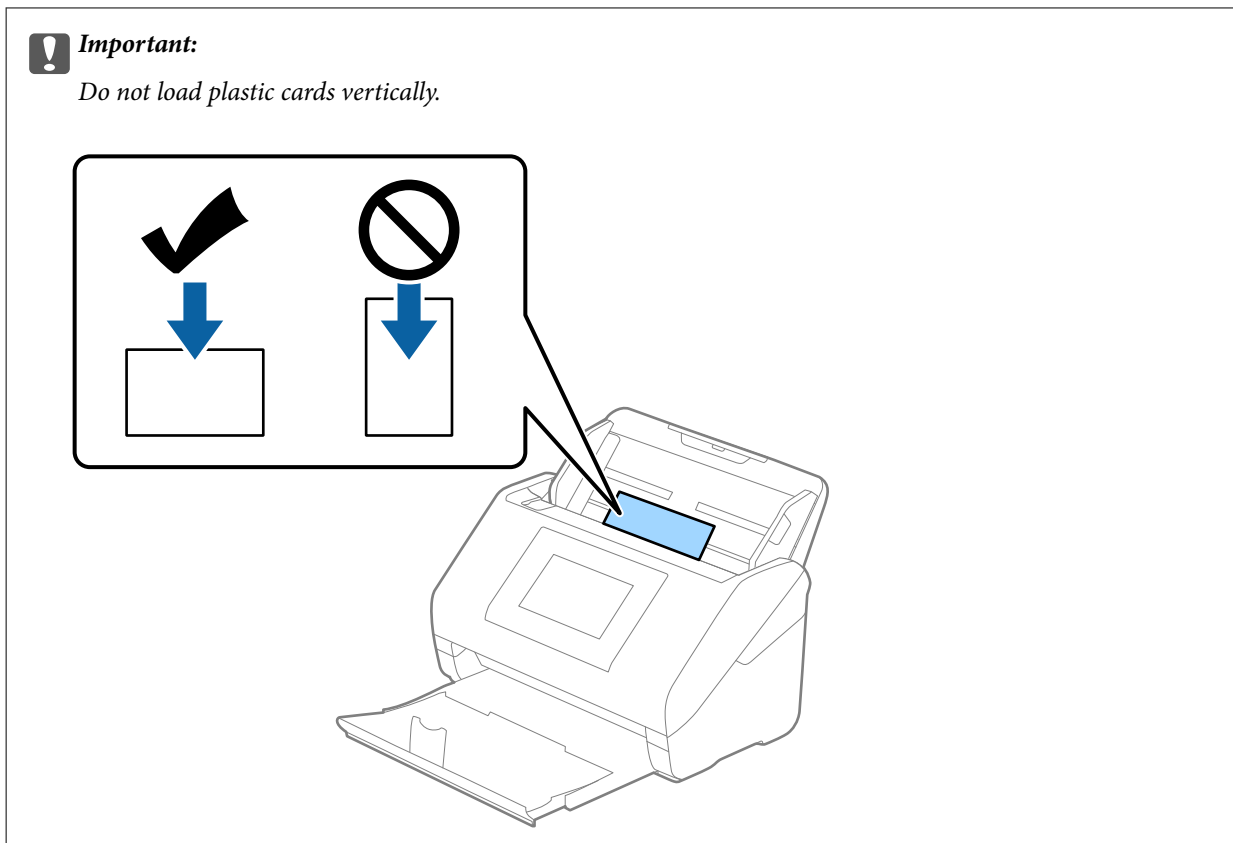

- Slide the edge guides to fit the edge of the plastic cards.

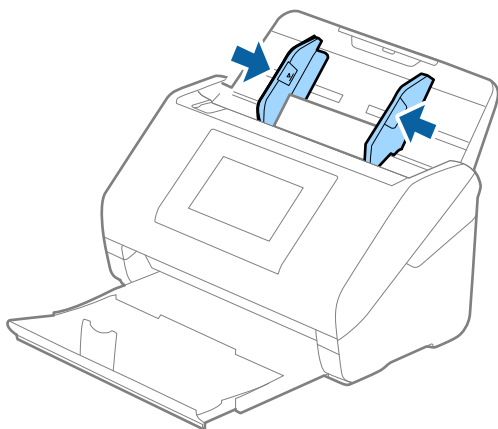

Note:

To scan plastic cards, set the appropriate setting in the Epson Scan 2 window.

When you are using Document Capture Pro, you can open the window by pressing the **Detailed Settings** button on the **Scan Settings** screen.

Select **Plastic Card** in **Document Size** or select **Off** in **Detect Double Feed** on the **Main Settings** tab in Epson Scan 2. See the Epson Scan 2 help for details.

If **Detect Double Feed** in the Epson Scan 2 window is enabled and a double feed error occurs, remove the card from the ADF and then reload it, tap **DFDS Function** on the control panel's screen to set it to **On** which disables **Detect Double Feed** for the next scan, and then scan again. The **DFDS Function** (Double Feed Detection Skip function) only disables **Detect Double Feed** for one sheet.

Related Information

➔ [“Required Settings for Special Originals in Epson Scan 2 Window” on page 113](#)

Laminated Cards

Specifications of Laminated Cards

The specification of laminated cards you can load into the scanner.

Size	Thickness	Loading Capacity
120.0×150.0 mm (4.7×5.9 in.) or less	0.8 mm (0.03 in.) or less	1 card

Note:

You cannot scan laminated cards using Epson Smart Panel.

Placing Laminated Cards

1. Slide out the output tray and raise the stopper.

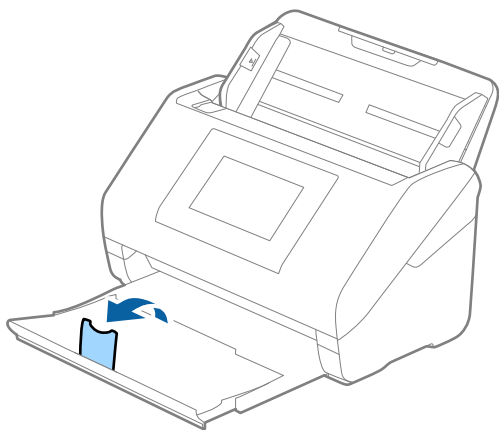

2. Slide the edge guides on the input tray all the way out.

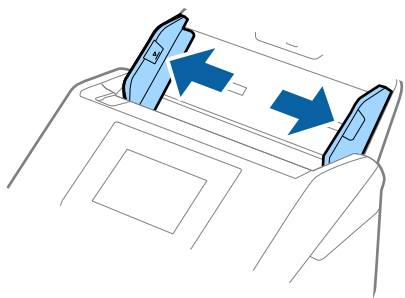

3. Load the laminated cards into the input tray facing down with the top edge facing into the ADF.
Slide the laminated cards into the ADF until they meet resistance.

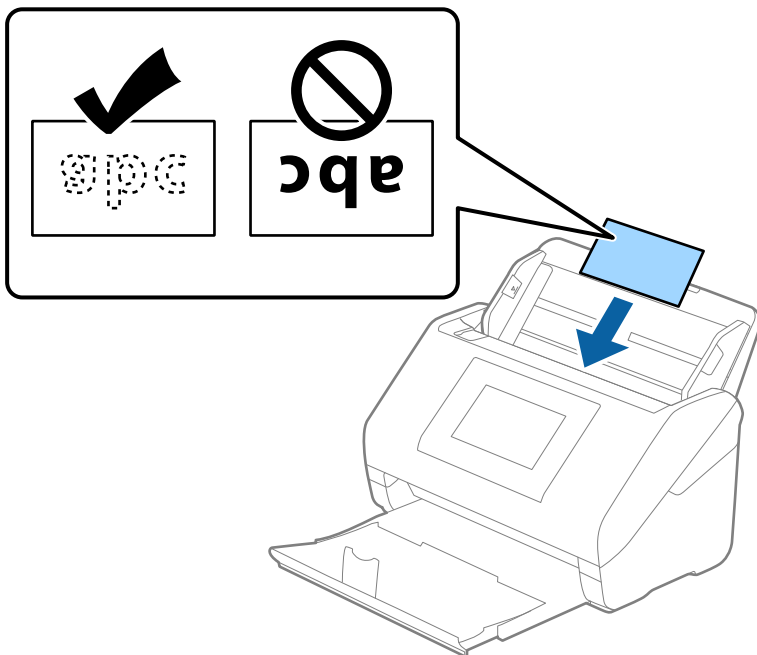

4. Slide the edge guides to fit the edge of the laminated cards.

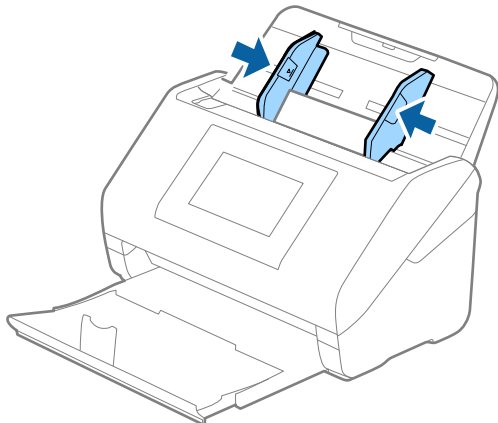

Note:

To scan laminated cards, set the appropriate setting in the Epson Scan 2 window.

When you are using Document Capture Pro, you can open the window by pressing the **Detailed Settings** button on the **Scan Settings** screen.

- ❑ To increase the accuracy of auto size detection, select the **Main Settings** tab > **Document Size** > **Settings** > **Scan laminated card**. See the Epson Scan 2 help for details.
- ❑ Select the **Main Settings** tab > **Detect Double Feed** > **Off**. See the Epson Scan 2 help for details.

If **Detect Double Feed** is enabled in the Epson Scan 2 window and a double feed error occurs, remove the card from the ADF and then reload it, tap **DFDS Function** on the control panel's screen to set it to **On** which disables **Detect Double Feed** for the next scan, and then scan again. The **DFDS Function** (Double Feed Detection Skip function) only disables **Detect Double Feed** for one sheet.

Related Information

➔ [“Required Settings for Special Originals in Epson Scan 2 Window” on page 113](#)

Large Size Originals

Specifications of Large Size Originals

By using the Carrier Sheet sold separately and folding the originals in half, you can scan originals larger than A4 size, such as A3 or B4 sizes.

Size	Thickness	Paper Type	Loading Capacity of the Carrier Sheet
Up to A3	0.3 mm (0.012 in.) or less (excluding the thickness of the Carrier Sheet)	Plain paper Fine paper Recycled paper	10 carrier sheets

Placing Large Size Originals

1. Extend the input tray extension. Slide out the output tray, extend the output tray extension, and then raise the stopper.

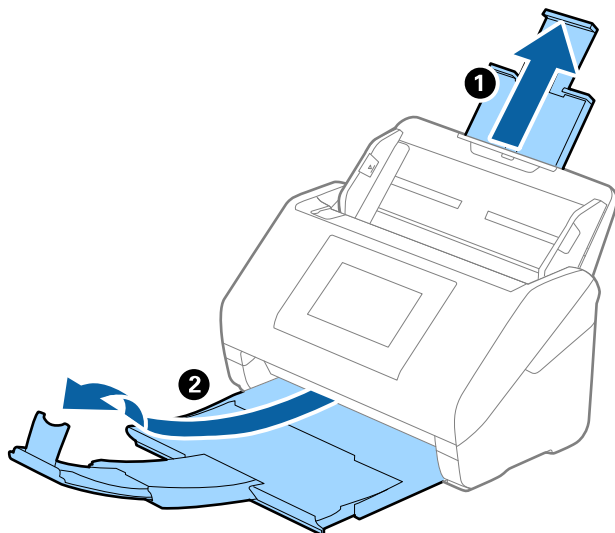

- Slide the edge guides on the input tray all the way out.

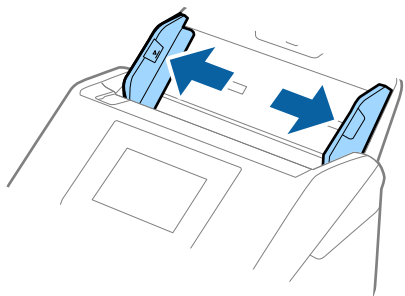

- Place the Carrier Sheet with the illustration on the front edge facing up and place the original in the carrier sheet by folding it in half so that the side to be scanned is facing out, with the right side at the front.

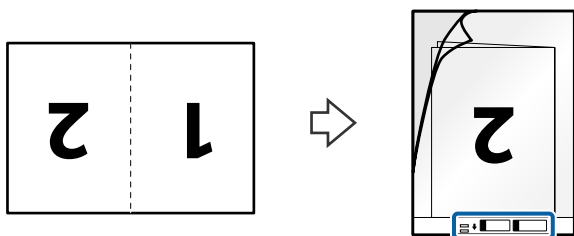

- Load the Carrier Sheet into the input tray with the top edge (bound edge) facing into the ADF. Make sure that the side with usage instructions is facing up. Slide the Carrier Sheet into the ADF until it meets resistance.

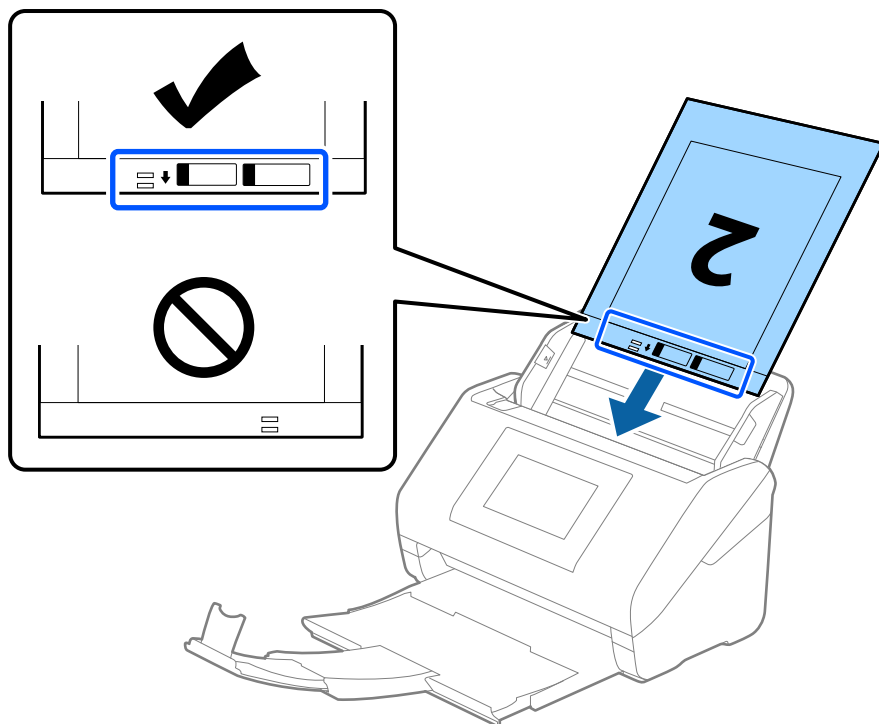

5. Slide the edge guides to fit the edge of the Carrier Sheet making sure there are no gaps between the Carrier Sheet and the edge guides. Otherwise, the carrier sheet may be fed skewed.

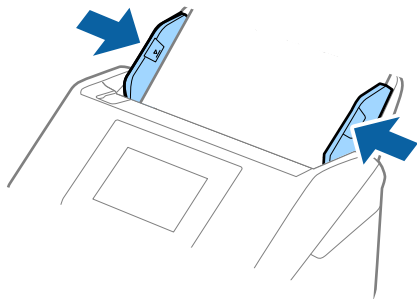

Note:

- You may need to stop using a Carrier Sheet that is scratched or has been scanned more than 3,000 times.
- To scan both sizes and stitch them together, set the appropriate setting in the Epson Scan 2 window.
When you are using Document Capture Pro, you can open the window by pressing the **Detailed Settings** button on the **Scan Settings** screen.
Select **Double-Sided** from **Scanning Side** and select **Left & Right** from **Stitch Images** in the Epson Scan 2 window. See the Epson Scan 2 help for details.
- When scanning a Carrier Sheet by selecting **Auto Detect** as the **Document Size** setting, the image is automatically scanned by applying **Paper Skew** in the **Correct Document Skew** setting.
- The leading edge of the original must be placed at the binding part of the Carrier Sheet when scanning an original approximately 297 mm long. Otherwise, the length of the scanned image may be longer than intended as the scanner scans to the end of the Carrier Sheet when you select **Auto Detect** as the **Document Size** setting in the Epson Scan 2 window.
- Only use the Carrier Sheet designed for your scanner. The Carrier Sheet is automatically recognized by the scanner by detecting two small rectangular holes on the front edge. Keep the holes clean and not covered.

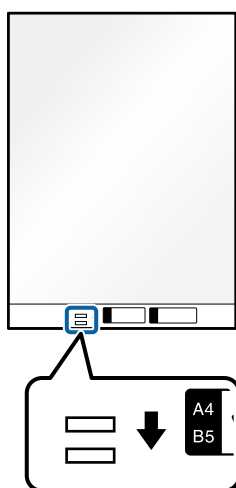

Related Information

- ➔ [“Carrier Sheet Codes” on page 37](#)
- ➔ [“Required Settings for Special Originals in Epson Scan 2 Window” on page 113](#)

Irregular Shaped Originals

Specifications of Irregular Shaped Originals

By using the Carrier Sheet sold separately, you can scan originals that are wrinkled, curled, very thin, or irregularly shaped.

Size	Thickness	Loading Capacity of the Carrier Sheet
Up to A4	0.3 mm (0.012 in.) or less (excluding the thickness of the Carrier Sheet)	10 sheets

Placing Irregular Shaped Originals

1. Extend the input tray extension. Slide out the output tray, extend the output tray extension, and then raise the stopper.

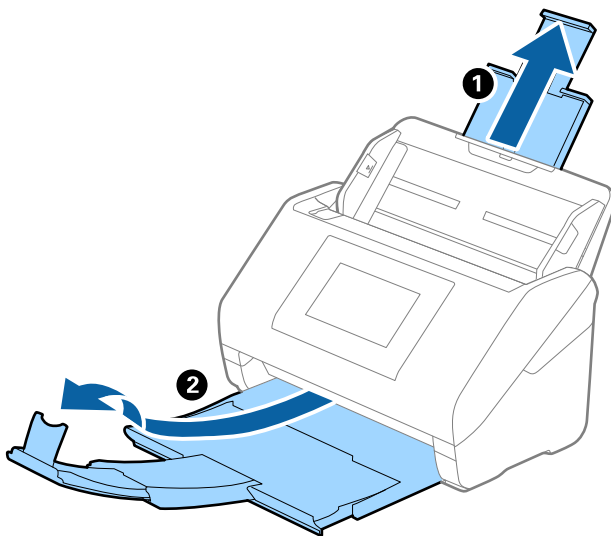

2. Slide the edge guides on the input tray all the way out.

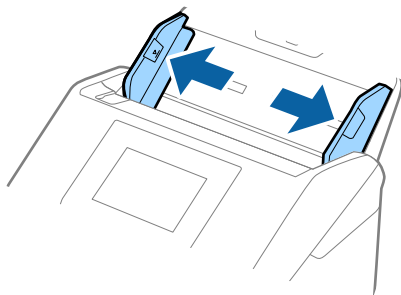

3. Place the Carrier Sheet with the illustration on the front edge facing up and place the original in the center of the Carrier Sheet with the side to be scanned facing down.

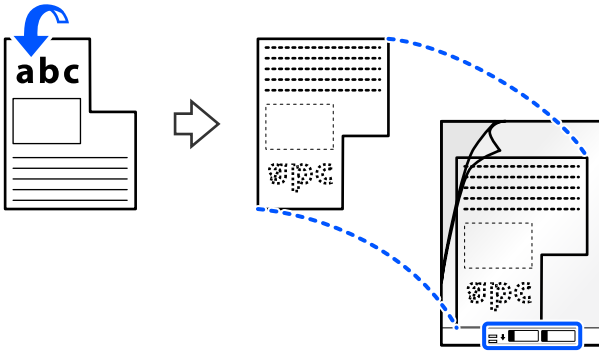

4. Load the Carrier Sheet into the input tray with the top edge (bound edge) facing into the ADF. Make sure that the side with usage instructions is facing up. Slide the Carrier Sheet into the ADF until it meets resistance.

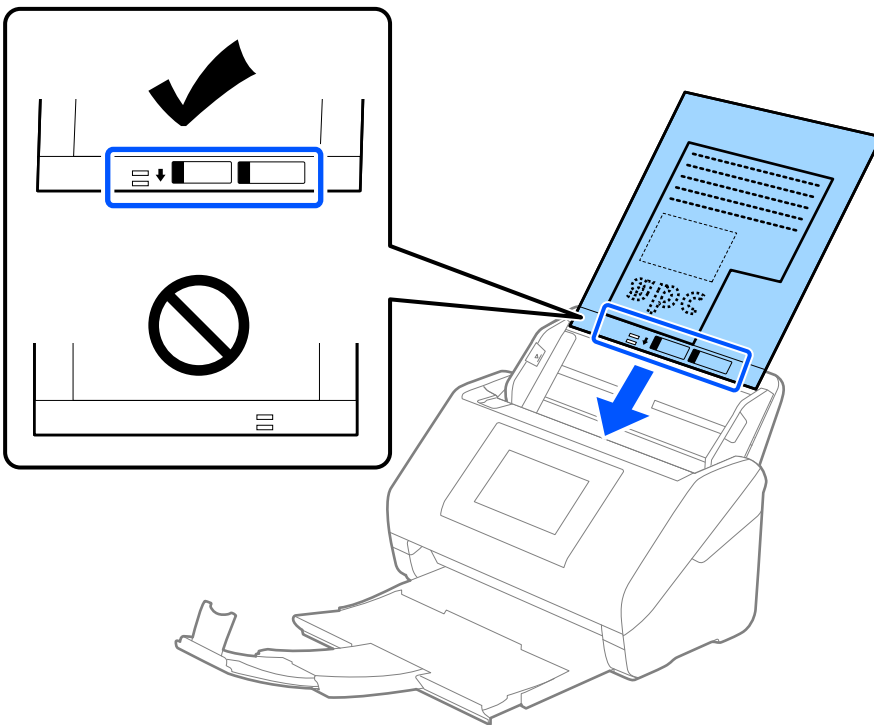

- Slide the edge guides to fit the edge of the Carrier Sheet making sure there are no gaps between the Carrier Sheet and the edge guides. Otherwise, the carrier sheet may be fed skewed.

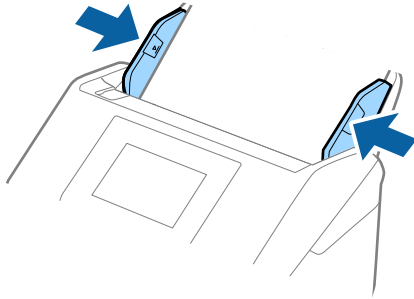

Note:

- You may need to stop using a Carrier Sheet that is scratched or has been scanned more than 3,000 times.
- If you cannot find an appropriate size for the original you want to scan in the **Document Size** list, select **Auto Detect**.
When using Epson Scan 2, you can also select **Customize** to create a custom document size.
- When scanning a Carrier Sheet by selecting **Auto Detect** as the **Document Size** setting, the image is automatically scanned by applying **Paper Skew** in the **Correct Document Skew** setting.
- Only use the Carrier Sheet designed for your scanner. The Carrier Sheet is automatically recognized by the scanner by detecting two small rectangular holes on the front edge. Keep the holes clean and not covered.

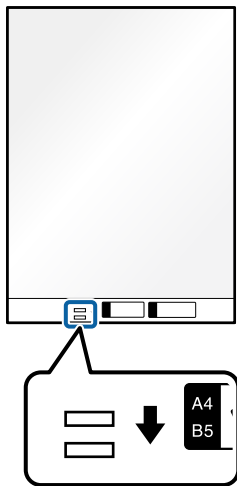

Related Information

- ➔ [“Carrier Sheet Codes” on page 37](#)
- ➔ [“Required Settings for Special Originals in Epson Scan 2 Window” on page 113](#)

Photographs

Specifications of Photographs

By using the Carrier Sheet sold separately, you can scan photographs without worrying about them being damaged.

Size	Thickness	Loading Capacity of the Carrier Sheet
Up to A4	0.3 mm (0.012 in.) or less (excluding the thickness of the Carrier Sheet)	10 sheets

Placing Photographs

1. Extend the input tray extension. Slide out the output tray, extend the output tray extension, and then raise the stopper.

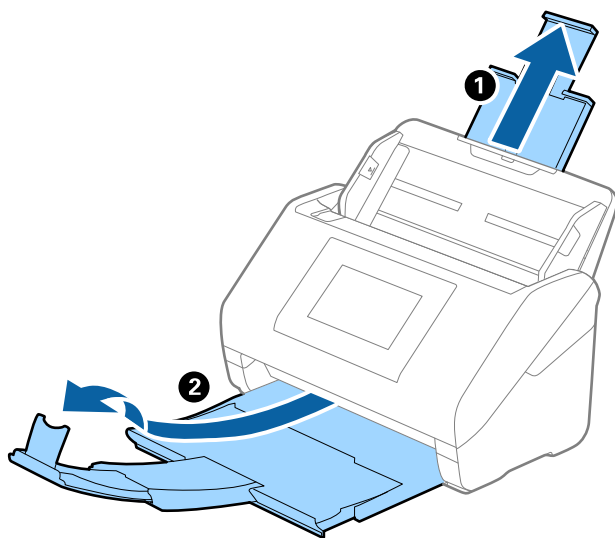

2. Slide the edge guides on the input tray all the way out.

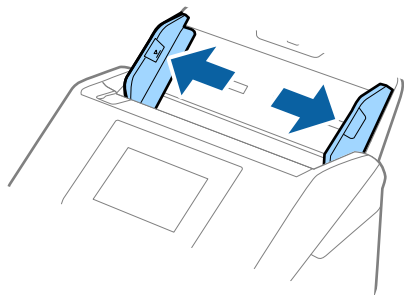

- Place the Carrier Sheet with the illustration on the front edge facing up and place the photo in the center of the Carrier Sheet with the side to be scanned facing down.

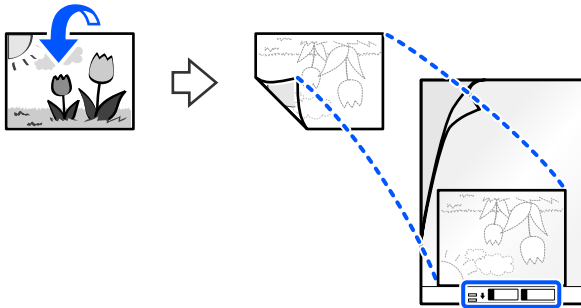

- Load the Carrier Sheet into the input tray with the top edge (bound edge) facing into the ADF. Make sure that the side with usage instructions is facing up. Slide the Carrier Sheet into the ADF until it meets resistance.

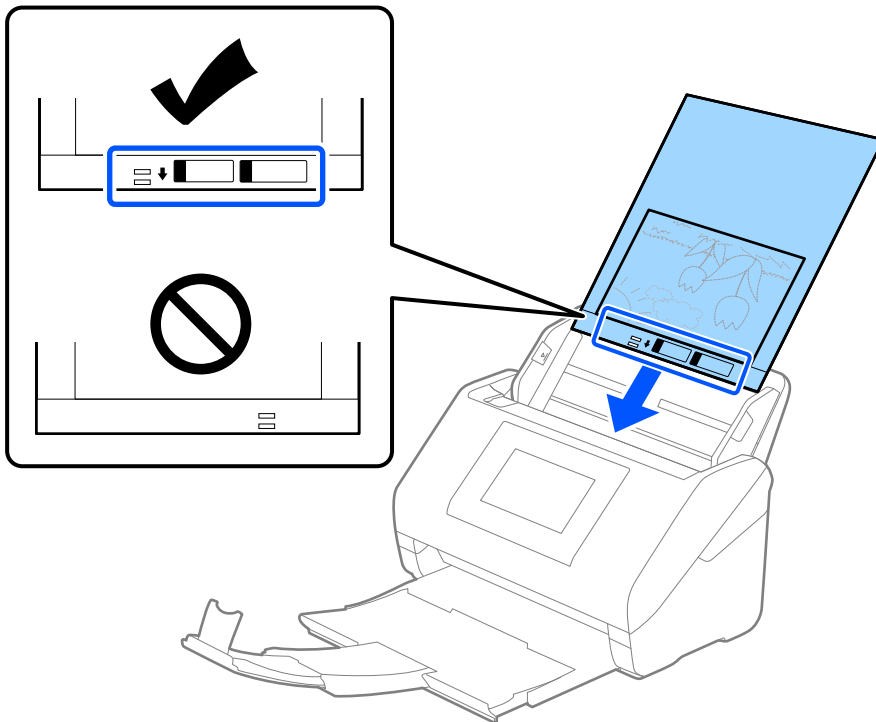

- Slide the edge guides to fit the edge of the Carrier Sheet making sure there are no gaps between the Carrier Sheet and the edge guides. Otherwise, the carrier sheet may be fed skewed.

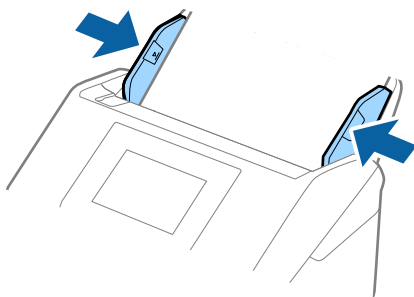

Note:

- ❑ You may need to stop using a Carrier Sheet that is scratched or has been scanned more than 3,000 times.
- ❑ If you cannot find an appropriate size for the original you want to scan in the **Document Size** list, select **Auto Detect**.
When using Epson Scan 2, you can also select **Customize** to create a custom document size.
- ❑ When scanning a Carrier Sheet by selecting **Auto Detect** as the **Document Size** setting, the image is automatically scanned by applying **Paper Skew** in the **Correct Document Skew** setting.
- ❑ Do not leave photos inside the Carrier Sheet for a long time.
- ❑ Only use the Carrier Sheet designed for your scanner. The Carrier Sheet is automatically recognized by the scanner by detecting two small rectangular holes on the front edge. Keep the holes clean and not covered.

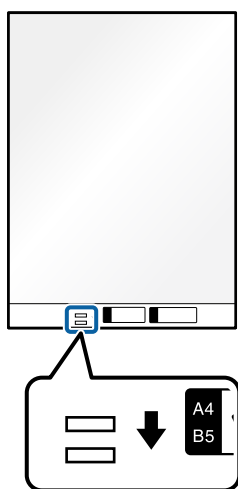

Related Information

- ➔ [“Carrier Sheet Codes” on page 37](#)
- ➔ [“Required Settings for Special Originals in Epson Scan 2 Window” on page 113](#)

Envelopes

Specifications of Envelopes

The specification of envelopes you can load into the scanner.

Size	Measurement	Thickness	Loading Capacity
C6	114×162 mm (4.49×6.38 in.) (standard size)	0.38 mm (0.015 in.) or less	10 envelopes
DL	110×220 mm (4.33×8.66 in.) (standard size)		

Placing Envelopes

1. Extend the input tray extension. Slide out the output tray, extend the output tray extension, and then raise the stopper.

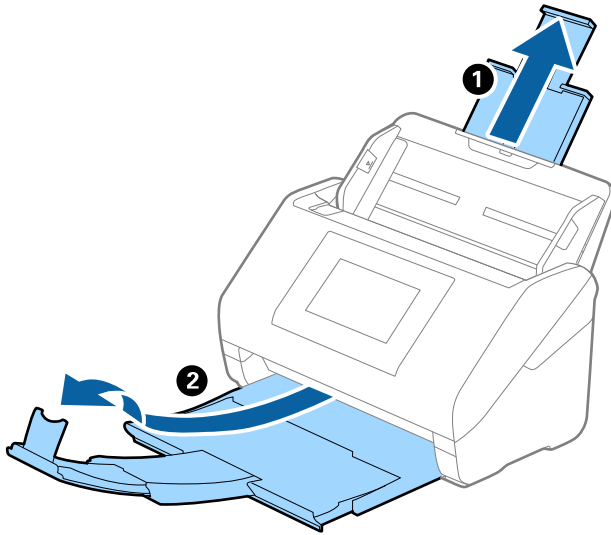

2. Slide the edge guides on the input tray all the way out.

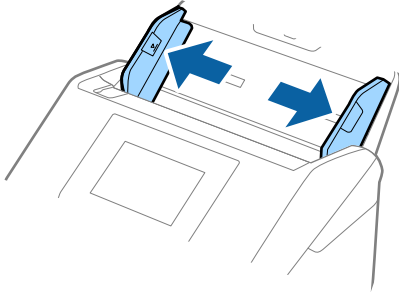

3. Load the envelopes into the input tray facing down making sure that the opened edge (flap side) of the envelope is facing to the side. For envelopes with the opened edge (flap side) on the shorter side, you can load the envelope with the opened edge (flap side) facing up.

Slide the envelopes into the ADF until they meet resistance.

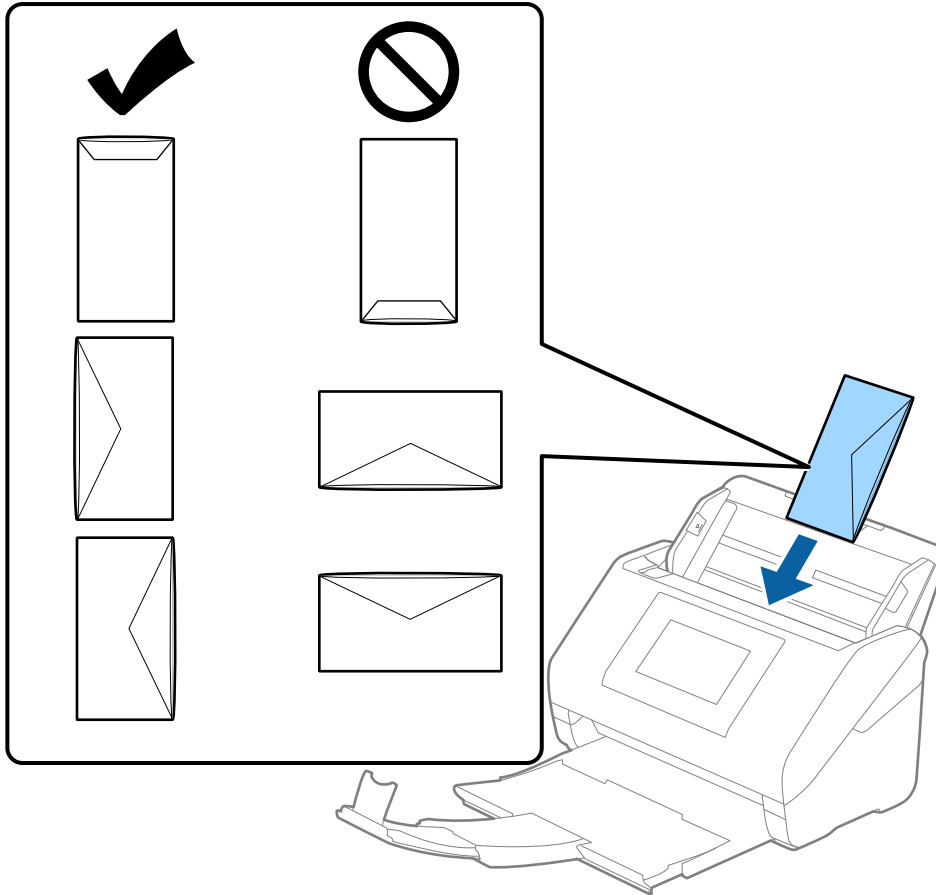

Important:

Do not load envelopes with adhesives on them.

Note:

- Envelopes that are not opened by cutting sharply at the flap edge may not be scanned correctly.
- Envelopes that have not yet been sealed can be loaded with the flap open and facing up.

- Slide the edge guides to fit the edge of the envelopes making sure there are no gaps between the envelopes and the edge guides. Otherwise, the envelopes may be fed skewed.

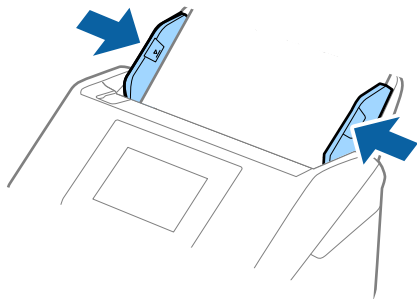

Note:

- We recommend selecting the appropriate rotation angle or **Auto** as the **Rotate** setting in the application.
- To scan envelopes, set the appropriate setting in the Epson Scan 2 window.
When you are using Document Capture Pro, you can open the window by pressing the **Detailed Settings** button on the **Scan Settings** screen.

Select **Main Settings** tab > **Detect Double Feed** > **Off**. See the Epson Scan 2 help for details.

Detect Double Feed is enabled in the Epson Scan 2 window and a double feed error occurs, remove the envelope from the ADF and then reload it, tap **DFDS Function** on the control panel's screen to set it to **On** which disables **Detect Double Feed** for the next scan, and then scan again. The **DFDS Function** (Double Feed Detection Skip function) only disables **Detect Double Feed** for one sheet.

Related Information

➔ [“Required Settings for Special Originals in Epson Scan 2 Window” on page 113](#)

Mixture of Originals

Specifications of Originals that are a Mixture of Different Sizes

You can load a mixture of originals from 50.8×50.8 mm (2.0×2.0 in.) to A4 (or Letter) size. You can also load a mixture of paper types or thickness.

You can improve the alignment of ejected originals by using the optional or supplied Paper Alignment Plate.

Important:

- When placing and scanning originals that are a mixture of different sizes, originals may be fed askew because not all of the originals are supported by edge guides.
- Originals may be jammed or fed askew if you set different types or very different sizes of originals, such as in the following cases.
 - Thin paper and Thick paper
 - A4 size paper and card size paper
 If originals are fed askew, check whether or not the scanned image is available.

Note:

- ❑ If originals are jammed or are not fed correctly, enabling **Slow mode** may improve feeding.
- ❑ Alternatively, you can scan originals of different paper sizes and types by loading them one by one using **Automatic Feeding Mode**.

Related Information

➔ [“Paper Alignment Plate Codes” on page 38](#)

Placing a Mixture of Originals at Different Sizes

1. Extend the input tray extension. Slide out the output tray, extend the output tray extension, and then raise the stopper.

Note:

If there are any thick originals, to stop them from bumping into the output tray and falling out, store the output tray and do not use it to stack the ejected originals.

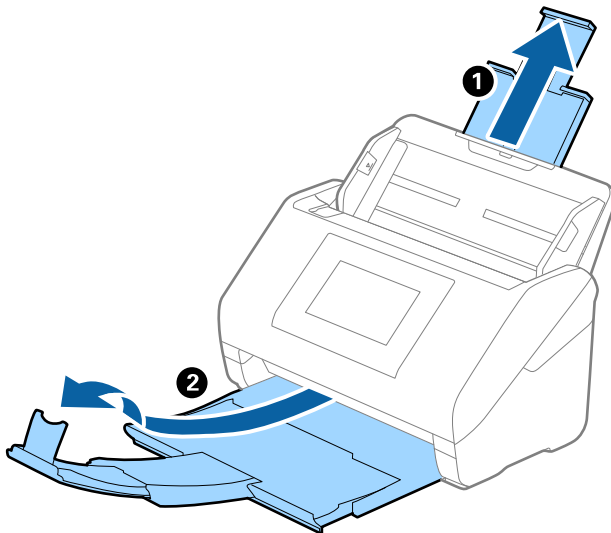

2. Slide the edge guides on the input tray all the way out.

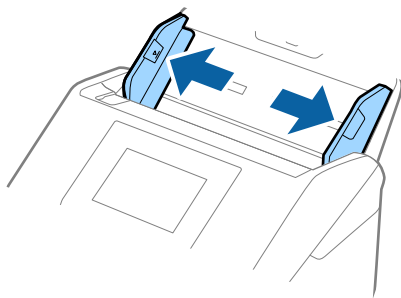

3. Load the originals at the center of the input tray in descending order of paper size with the widest at the back and the narrowest at the front.

! **Important:**

Check the following points when setting different sizes of originals.

- Slide the originals with their leading edges aligned, until they meet resistance in the ADF.
- Set the originals at the center of the input tray. Refer to the ▲ mark on the scanner as your guide.
- Set the originals straight.

If not, originals may be fed askew or jammed.

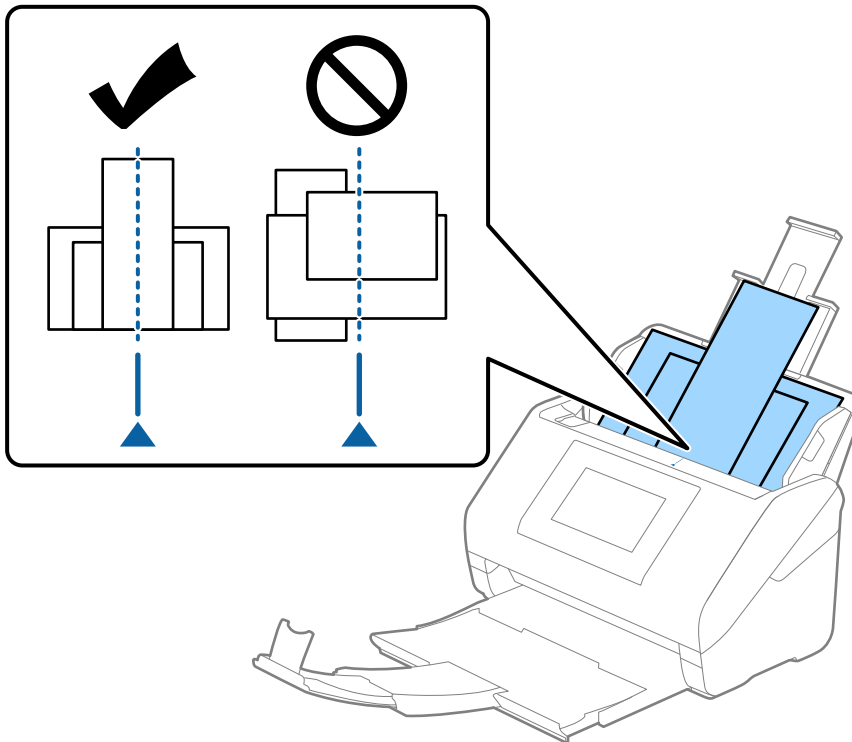

Note:

Load the originals into the input tray facing down and slightly displace the top edges at an angle facing into the ADF.

4. Slide the edge guides to fit the edges of the widest original.

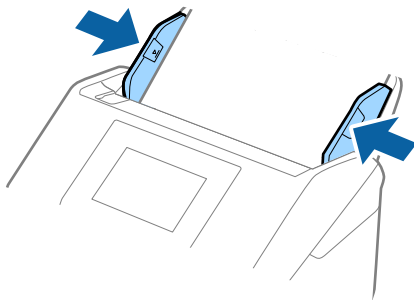

Related Information

➔ [“Scanning in Automatic Feeding Mode” on page 118](#)

Scanning

Scanning Using the Scanner's Control Panel.	77
Scanning Using Presets Settings.	97
Scanning from a Computer.	97
Setting a Job.	116
Scanning in Automatic Feeding Mode.	118
Scanning from a Smart Device.	120

Scanning Using the Scanner's Control Panel

You can save scanned images from the scanner's control panel to the following destinations.

Computer

You can save the scanned image to a computer connected to the scanner.

Network Folder/FTP

You can save the scanned image to a pre-configured network folder.

Email

You can send the scanned image by email directly from the scanner through a pre-configured email server.

Cloud

You can send the scanned image directly to cloud services that have been registered in advance.

USB Drive

You can save the scanned image directly to a USB drive connected to the scanner.

WSD

You can save the scanned image to a computer connected to the scanner using the WSD feature.

Related Information

- ➔ [“Scanning Originals to a Computer” on page 77](#)
- ➔ [“Scanning to a Network Folder” on page 78](#)
- ➔ [“Scanning Originals to an Email” on page 83](#)
- ➔ [“Scanning to the Cloud” on page 87](#)
- ➔ [“Scanning to a USB Drive” on page 91](#)
- ➔ [“Scanning Using WSD” on page 95](#)

Scanning Originals to a Computer

You can scan originals from the control panel by using jobs created in Document Capture Pro (Windows)/ Document Capture (Mac OS).

Note:

- Before scanning, install Document Capture Pro/Document Capture on your computer, create the job, and then assign the job on the control panel. There is a preset job that saves scanned images as PDF.
- Before scanning, make sure that the scanner is correctly connected to the computer.

1. Place the originals.
2. Select **Computer** on the home screen on the scanner's control panel.
3. If the **Select Computer** screen is displayed, select the computer.

Note:

The scanner's control panel displays up to 111 computers on which Document Capture Pro is installed.

- If the **Select Job** screen is displayed, select the job.

Note:

If you have set only one job, you do not need to select the job. Proceed to the next step.

- Confirm the computer and the job you selected.

Note:

Select ★ to save your settings as a preset.

- Tap ⬇.

Document Capture Pro automatically starts on your computer, and scanning starts.

Related Information

- ➔ “Setting a Job” on page 116
- ➔ “Creating a Job and Assigning a Job to the Control Panel (Windows)” on page 117
- ➔ “Assigning a Job to the Control Panel (Mac OS)” on page 117

Scanning to a Network Folder

You can save the scanned image to a specified folder on a network. You can specify the folder by entering a folder path directly, but it may be easier if you register the folder information in the contacts list first.

Before scanning, you need to set a network folder or FTP server.

Note:

- Make sure the scanner’s **Date/Time** and **Time Difference** settings are correct. Select **Settings > Basic Settings > Date/Time Settings** on the control panel.
- You can check destination before scanning. Select **Settings > Scanner Settings**, and then enable the **Confirm Recipient**.

- Place the originals.
- Select **Network Folder/FTP** on the home screen of the scanner’s control panel.
- Specify the folder.

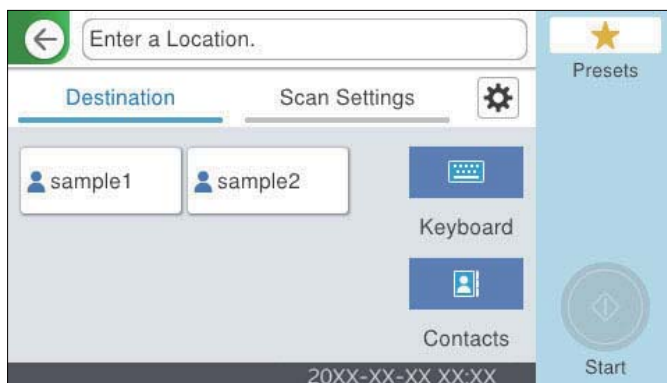

- To select frequently used addresses: Select the icons displayed on the screen.
- To enter the folder path directly: Select **Keyboard**. Select **Communication Mode**, and then enter the folder path as the **Location (Required)**. Set the other items necessary.

- To select from the contacts list: Select **Contacts**, select a contact, and then select **Close**.

You can search for a folder from the contacts list. Enter the search keyword into the box at the top of the screen.

4. Select **Scan Settings**, check settings such as the save format, and then change them if necessary.

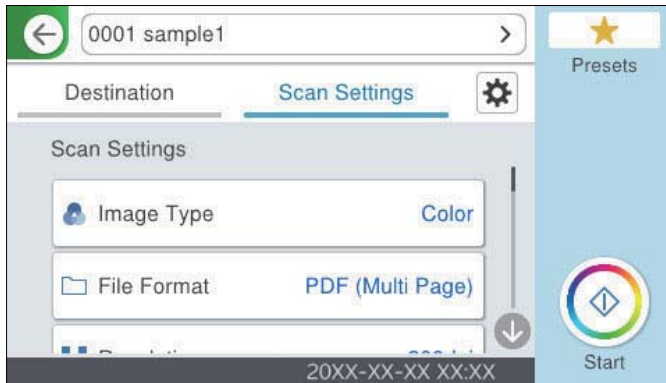

Note:

Select  to save your settings as a preset.

5. Select , check the **Scanner Settings**, and then change them if necessary.

You can change the settings such as **Slow** or **DFDS Function**.

6. Tap .

Related Information

➔ [“Creating a Network Folder” on page 126](#)

Destination Menu Options for Scanning to a Folder

Keyboard:

Open the **Edit Location** screen. Enter the folder path and set each item on the screen.

- Communication Mode

Select the communication mode for the folder.

Location (Required)

Enter a folder path in which to save the scanned image. Enter the folder path in the following format.

When using SMB: \\host name\folder name

When using FTP: ftp://host name/folder name

When using FTPS: ftps://host name/folder name

When using WebDAV (HTTP)*: http://host name/folder name

When using WebDAV (HTTPS)*: https://host name/folder name

*SharePoint Online is not supported when scanning to **Network Folder/FTP** from the scanner's control panel.

If you want to save the scanned image to SharePoint Online, use Document Capture Pro after installing the SharePoint Online Connector. See the Document Capture Pro manual for details.

<https://support.epson.net/dcp/>

User Name

Enter a user name to log on to the specified folder.

Password

Enter a password corresponding to the user name.

Connection Mode

Select the connection mode for the folder.

Port Number

Enter a port number for the folder.

Proxy Server Settings:

Select whether or not to use a proxy server.

Contacts:

Select a folder in which to save the scanned image from the contacts list.

Scan Menu Options for Scanning to a Folder

Note:

The items may not be available depending on other settings you made.

Image Type:

Select the color of the output image.

When you select the following, the scanner detects the color of the originals automatically and saves the images using the detected colors.

Color/Grayscale/B&W

Converts the scanned image into 24-bit color, 8-bit gray, or monochrome (black and white binary). When this is selected, set the sensitivity to determine whether the original is grayscale or monochrome when scanning a non-color original.

Color/Grayscale:

Converts the scanned image into 24-bit color or 8-bit gray.

Color/Black & White:

Converts the scanned image into 24-bit color or monochrome (black and white binary).

The available image types may vary depending on the File Format you selected. See the following for more details.

[“Combinations for Available File Format and Image Type” on page 95](#)

File Format:

Select the format in which to save the scanned image.

When you want to save as PDF, PDF/A, or TIFF, select whether to save all originals as one file (multi-page) or save each original separately (single page).

Compression Ratio:

Select how much to compress the scanned image.

PDF Settings:

When you have selected PDF as the save format setting, use these settings to protect PDF files.

To create a PDF file that requires a password when opening, set Document Open Password. To create a PDF file that requires a password when printing or editing, set Permissions Password.

Resolution:

Select the scanning resolution.

Scanning Side:

Select the side of the original you want to scan.

Binding(Original):

Select the binding direction of the original.

Original Size:

Select the size of the original you placed.

Crop Margins for Size "Auto":

Adjust the cropping area when selecting **Auto Detect**.

Scan laminated card:

For laminated originals, transparent areas around the edges are also scanned.

Note:

The appropriate effects may not be achieved depending on the original.

Rotate:

Rotate the scanned image clockwise. Select the rotation angle depending on the original you want to scan.

Density:

Select the contrast of the scanned image.

Remove Background:

Remove the background color of the originals from the scanned image.

To use this feature, the background color of the originals should be the lightest color in the originals, and should be uniform. This feature is not applied correctly if there are patterns in the background, or there are text or illustrations which are a lighter color than the background.

Text Enhancement:

You can make blurred letters in the original clear and sharp. You can also reduce the offset or unevenness of the background.

Emphasize light letters / Remove background:

You can set the level of correction between text and background. When you move the slider closer to **Emphasize light letters**, the light letters in the scanned image are emphasized. When you move the slider closer to **Remove background**, the background color, pattern, wrinkles, or offset in the scanned image is removed.

Remove spot noise:

You can remove black dots in the background of the original that cannot be removed by lightening the background. You can adjust the level of the effect.

Note:

When you select this feature, it may also remove small dots as well as the black dots in the background.

Remove Shadow:

Remove the shadows of the original that appear in the scanned image.

Frame:

Remove the shadows at the edge of the original.

Correct Document Skew:

Correct skew in the scanned image.

This feature may not be able to correct documents that have been over skewed.

Skip Blank Pages:

Skip blank pages when scanning if there are any in the originals.

If the result is not what you expected, adjust detection level.

Note:

Some pages may be incorrectly skipped as blank pages.

This feature is not available when scanning double-sided originals that are stitched.

Automatic Feeding Mode:

Set Automatic Feeding Mode. This feature allows you to continue scanning automatically after the originals are scanned. This feature is useful when scanning different sizes or types of originals one by one.

Adjust the edge guides of the scanner before placing each original.

On (Full-Auto): Start scanning when an original is set while the continuation confirmation message is displayed.

On (Semi-Auto): Start scanning when the **Start Scanning** button is pressed while the continuation confirmation message is displayed.

Detect Double Feed:

Display a warning when multiple originals are fed at the same time.

- Ultrasonic sensor: Detect a double feed using an ultrasonic sensor. You can specify the detection range.
- Length: Detect a double feed by the length. When the length of the second original scanned is different from the first, this is identified as a double feed. You can specify the difference in length for detection.

File Name:

- Filename Prefix:
Enter a prefix for the name of the images in alphanumeric characters and symbols.
- Add Date:
Add the date to the file name.
- Add Time:
Add the time to the file name.

Clear All Settings

Resets the scan settings to their defaults.

Scanning Originals to an Email

You can send the scanned image by email directly from the scanner. Before scanning, you need to configure the email server.

You can specify the email address by entering directly, but it may be easier if you register the email address in the contacts list first.

Note:

- Make sure the scanner's **Date/Time** and **Time Difference** settings are correct. Select **Settings > Basic Settings > Date/Time Settings** on the control panel.
- You can check destination before scanning. Select **Settings > Scanner Settings**, and then enable the **Confirm Recipient**.

1. Place the originals.
2. Select **Email** on the home screen of the scanner's control panel.
3. Specify the destination.



- To select frequently used addresses: Select the icons displayed on the screen.
- To enter the email address manually: Select **Keyboard**, enter the email address, and then select **OK**.

- ❑ To select from the contacts list: Select **Contacts**, select a contact or a group, and then select **Close**.
You can search for a contact from the contacts list. Enter the search keyword into the box at the top of the screen.
- ❑ To select from the history list: Select **History**, select a contact, and then select **Close**.

Note:

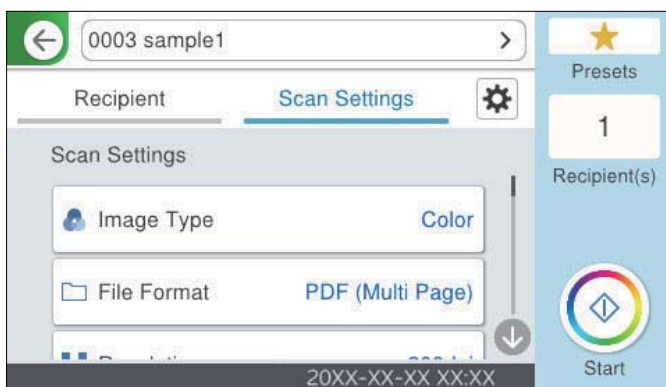

- ❑ *The number of recipients you selected is displayed on the right of the screen. You can send emails to up to 10 addresses and groups.
If groups is included in recipients, you can select up to 200 individual addresses in total, taking addresses in the groups into account.*
- ❑ *Select the address box at the top of the screen to display the list of selected addresses.*

4. Select **Scan Settings**, check settings such as the save format, and then change them if necessary.



Note:

Select  to save your settings as a preset.

5. Select , check the **Scanner Settings**, and then change them if necessary.
You can change the settings such as **Slow** or **DFDS Function**.
6. Tap .

Related Information

➔ [“Registering an Email Server” on page 123](#)

Scan Menu Options for Scanning to an Email

Note:

The items may not be available depending on other settings you made.

Image Type:

Select the color of the output image.

When you select the following, the scanner detects the color of the originals automatically and saves the images using the detected colors.

Color/Grayscale/B&W

Converts the scanned image into 24-bit color, 8-bit gray, or monochrome (black and white binary). When this is selected, set the sensitivity to determine whether the original is grayscale or monochrome when scanning a non-color original.

Color/Grayscale:

Converts the scanned image into 24-bit color or 8-bit gray.

Color/Black & White:

Converts the scanned image into 24-bit color or monochrome (black and white binary).

The available image types may vary depending on the File Format you selected. See the following for more details.

[“Combinations for Available File Format and Image Type” on page 95](#)

File Format:

Select the format in which to save the scanned image.

When you want to save as PDF, PDF/A, or TIFF, select whether to save all originals as one file (multi-page) or save each original separately (single page).

Compression Ratio:

Select how much to compress the scanned image.

PDF Settings:

When you have selected PDF as the save format setting, use these settings to protect PDF files.

To create a PDF file that requires a password when opening, set Document Open Password. To create a PDF file that requires a password when printing or editing, set Permissions Password.

Resolution:

Select the scanning resolution.

Scanning Side:

Select the side of the original you want to scan.

Binding(Original):

Select the binding direction of the original.

Original Size:

Select the size of the original you placed.

Crop Margins for Size "Auto":

Adjust the cropping area when selecting **Auto Detect**.

Scan laminated card:

For laminated originals, transparent areas around the edges are also scanned.

Note:

The appropriate effects may not be achieved depending on the original.

Rotate:

Rotate the scanned image clockwise. Select the rotation angle depending on the original you want to scan.

Density:

Select the contrast of the scanned image.

Remove Background:

Remove the background color of the originals from the scanned image.

To use this feature, the background color of the originals should be the lightest color in the originals, and should be uniform. This feature is not applied correctly if there are patterns in the background, or there are text or illustrations which are a lighter color than the background.

Text Enhancement:

You can make blurred letters in the original clear and sharp. You can also reduce the offset or unevenness of the background.

Emphasize light letters / Remove background:

You can set the level of correction between text and background. When you move the slider closer to **Emphasize light letters**, the light letters in the scanned image are emphasized. When you move the slider closer to **Remove background**, the background color, pattern, wrinkles, or offset in the scanned image is removed.

Remove spot noise:

You can remove black dots in the background of the original that cannot be removed by lightening the background. You can adjust the level of the effect.

Note:

When you select this feature, it may also remove small dots as well as the black dots in the background.

Remove Shadow:

Remove the shadows of the original that appear in the scanned image.

Frame:

Remove the shadows at the edge of the original.

Correct Document Skew:

Correct skew in the scanned image.

This feature may not be able to correct documents that have been over skewed.

Skip Blank Pages:

Skip blank pages when scanning if there are any in the originals.

If the result is not what you expected, adjust detection level.

Note:

Some pages may be incorrectly skipped as blank pages.

This feature is not available when scanning double-sided originals that are stitched.

Automatic Feeding Mode:

Set Automatic Feeding Mode. This feature allows you to continue scanning automatically after the originals are scanned. This feature is useful when scanning different sizes or types of originals one by one.

Adjust the edge guides of the scanner before placing each original.

On (Full-Auto): Start scanning when an original is set while the continuation confirmation message is displayed.

- On (Semi-Auto): Start scanning when the **Start Scanning** button is pressed while the continuation confirmation message is displayed.

Detect Double Feed:

Display a warning when multiple originals are fed at the same time.

- Ultrasonic sensor: Detect a double feed using an ultrasonic sensor. You can specify the detection range.
- Length: Detect a double feed by the length. When the length of the second original scanned is different from the first, this is identified as a double feed. You can specify the difference in length for detection.

Subject:

Enter a subject for the email in alphanumeric characters and symbols.

Attached File Max Size:

Select the maximum file size that can be attached to the email.

File Name:

- Filename Prefix:

Enter a prefix for the name of the images in alphanumeric characters and symbols.

- Add Date:

Add the date to the file name.

- Add Time:

Add the time to the file name.

Clear All Settings

Resets the scan settings to their defaults.

Scanning to the Cloud

You can send scanned images to cloud services. Before using this feature, make settings using Epson Connect. See the Epson Connect portal website for details.

<https://www.epsonconnect.com/>

<http://www.epsonconnect.eu> (Europe only)

1. Place the originals.
2. Select **Cloud** on the home screen of the scanner's control panel.
3. Select  on the top of the screen, and then select a destination.

4. Set items on **Basic Settings** tab, such as the save format.

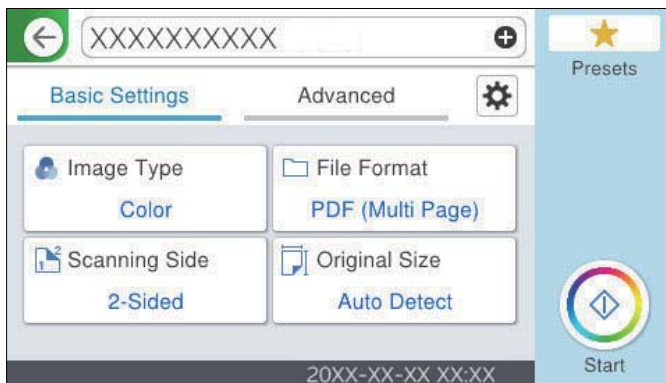

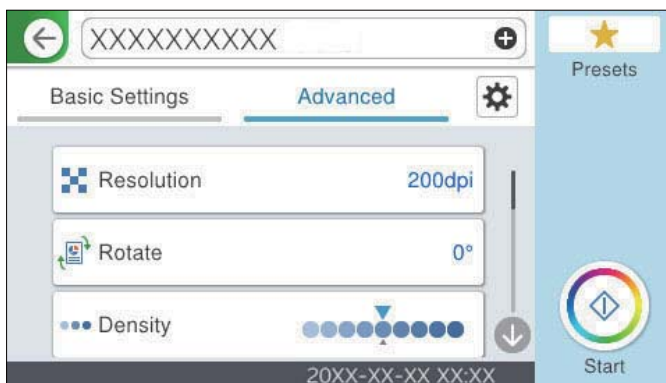

5. Select **Advanced**, and then check settings, and change them if necessary.



Note:

Select  to save your settings as a preset.

6. Select , check the **Scanner Settings**, and then change them if necessary.
You can change the settings such as **Slow** or **DFDS Function**.
7. Tap .

Basic Menu Options for Scanning to the Cloud

Note:

The items may not be available depending on other settings you made.

Image Type:

Select the color of the output image.

When you select the following, the scanner detects the color of the originals automatically and saves the images using the detected colors.

- Color/Grayscale:

Converts the scanned image into 24-bit color or 8-bit gray.

The available image types may vary depending on the File Format you selected. See the following for more details.

[“Combinations for Available File Format and Image Type” on page 95](#)

File Format:

Select the format in which to save the scanned image.

When you want to save as PDF, select whether to save all originals as one file (multi-page) or save each original separately (single page).

Scanning Side:

Select the side of the original you want to scan.

Binding(Original):

Select the binding direction of the original.

Original Size:

Select the size of the original you placed.

Crop Margins for Size "Auto":

Adjust the cropping area when selecting **Auto Detect**.

Scan laminated card:

For laminated originals, transparent areas around the edges are also scanned.

Note:

The appropriate effects may not be achieved depending on the original.

Advanced Menu Options for Scanning to the Cloud

Note:

The items may not be available depending on other settings you made.

Resolution:

Select the scanning resolution.

Rotate:

Rotate the scanned image clockwise. Select the rotation angle depending on the original you want to scan.

Density:

Select the contrast of the scanned image.

Remove Background:

Remove the background color of the originals from the scanned image.

To use this feature, the background color of the originals should be the lightest color in the originals, and should be uniform. This feature is not applied correctly if there are patterns in the background, or there are text or illustrations which are a lighter color than the background.

Text Enhancement:

You can make blurred letters in the original clear and sharp. You can also reduce the offset or unevenness of the background.

Emphasize light letters / Remove background:

You can set the level of correction between text and background. When you move the slider closer to **Emphasize light letters**, the light letters in the scanned image are emphasized. When you move the slider closer to **Remove background**, the background color, pattern, wrinkles, or offset in the scanned image is removed.

Remove spot noise:

You can remove black dots in the background of the original that cannot be removed by lightening the background. You can adjust the level of the effect.

Note:

When you select this feature, it may also remove small dots as well as the black dots in the background.

Remove Shadow:

Remove the shadows of the original that appear in the scanned image.

Frame:

Remove the shadows at the edge of the original.

Correct Document Skew:

Correct skew in the scanned image.

This feature may not be able to correct documents that have been over skewed.

Skip Blank Pages:

Skip blank pages when scanning if there are any in the originals.

If the result is not what you expected, adjust detection level.

Note:

Some pages may be incorrectly skipped as blank pages.

This feature is not available when scanning double-sided originals that are stitched.

Automatic Feeding Mode:

Set Automatic Feeding Mode. This feature allows you to continue scanning automatically after the originals are scanned. This feature is useful when scanning different sizes or types of originals one by one.

Adjust the edge guides of the scanner before placing each original.

On (Full-Auto): Start scanning when an original is set while the continuation confirmation message is displayed.

On (Semi-Auto): Start scanning when the **Start Scanning** button is pressed while the continuation confirmation message is displayed.

Detect Double Feed:

Display a warning when multiple originals are fed at the same time.

Ultrasonic sensor: Detect a double feed using an ultrasonic sensor. You can specify the detection range.

- ❑ Length: Detect a double feed by the length. When the length of the second original scanned is different from the first, this is identified as a double feed. You can specify the difference in length for detection.

Clear All Settings

Resets the scan settings to their defaults.

Scanning to a USB Drive

You can save the scanned image to a USB drive.

1. Place the originals.
2. Insert a USB drive into the scanner's external interface USB port.
3. Select **USB Drive** on the home screen of the scanner's control panel.
4. Set items on **Basic Settings** tab, such as the save format.

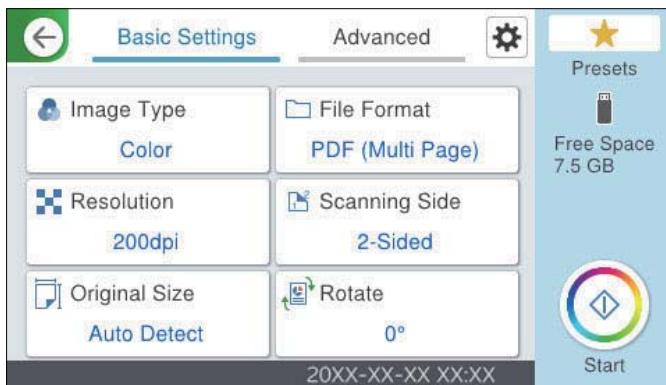

5. Select **Advanced**, and then check settings, and change them if necessary.

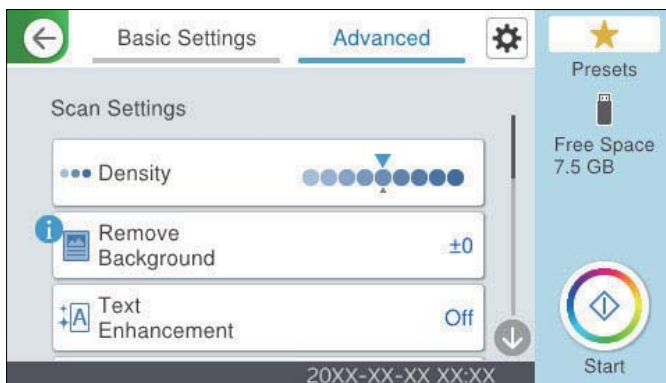

Note:

Select ★ to save your settings as a preset.

6. Select ⚙️, check the **Scanner Settings**, and then change them if necessary. You can change the settings such as **Slow** or **DFDS Function**.

7. Tap .

Related Information

➔ [“Inserting and Removing a USB Drive” on page 30](#)

Basic Menu Options for Scanning to a USB Drive

Note:

The items may not be available depending on other settings you made.

Image Type:

Select the color of the output image.

When you select the following, the scanner detects the color of the originals automatically and saves the images using the detected colors.

Color/Grayscale/B&W

Converts the scanned image into 24-bit color, 8-bit gray, or monochrome (black and white binary). When this is selected, set the sensitivity to determine whether the original is grayscale or monochrome when scanning a non-color original.

Color/Grayscale:

Converts the scanned image into 24-bit color or 8-bit gray.

Color/Black & White:

Converts the scanned image into 24-bit color or monochrome (black and white binary).

The available image types may vary depending on the File Format you selected. See the following for more details.

[“Combinations for Available File Format and Image Type” on page 95](#)

File Format:

Select the format in which to save the scanned image.

When you want to save as PDF, PDF/A, or TIFF, select whether to save all originals as one file (multi-page) or save each original separately (single page).

Compression Ratio:

Select how much to compress the scanned image.

PDF Settings:

When you have selected PDF as the save format setting, use these settings to protect PDF files.

To create a PDF file that requires a password when opening, set Document Open Password. To create a PDF file that requires a password when printing or editing, set Permissions Password.

Resolution:

Select the scanning resolution.

Scanning Side:

Select the side of the original you want to scan.

Binding(Original):

Select the binding direction of the original.

Original Size:

Select the size of the original you placed.

- Crop Margins for Size "Auto":

Adjust the cropping area when selecting **Auto Detect**.

- Scan laminated card:

For laminated originals, transparent areas around the edges are also scanned.

Note:

The appropriate effects may not be achieved depending on the original.

Rotate:

Rotate the scanned image clockwise. Select the rotation angle depending on the original you want to scan.

Advanced Menu Options for Scanning to a USB Drive

Note:

The items may not be available depending on other settings you made.

Density:

Select the contrast of the scanned image.

Remove Background:

Remove the background color of the originals from the scanned image.

To use this feature, the background color of the originals should be the lightest color in the originals, and should be uniform. This feature is not applied correctly if there are patterns in the background, or there are text or illustrations which are a lighter color than the background.

Text Enhancement:

You can make blurred letters in the original clear and sharp. You can also reduce the offset or unevenness of the background.

- Emphasize light letters / Remove background:

You can set the level of correction between text and background. When you move the slider closer to **Emphasize light letters**, the light letters in the scanned image are emphasized. When you move the slider closer to **Remove background**, the background color, pattern, wrinkles, or offset in the scanned image is removed.

- Remove spot noise:

You can remove black dots in the background of the original that cannot be removed by lightening the background. You can adjust the level of the effect.

Note:

When you select this feature, it may also remove small dots as well as the black dots in the background.

Remove Shadow:

Remove the shadows of the original that appear in the scanned image.

- Frame:

Remove the shadows at the edge of the original.

Correct Document Skew:

Correct skew in the scanned image.

This feature may not be able to correct documents that have been over skewed.

Skip Blank Pages:

Skip blank pages when scanning if there are any in the originals.

If the result is not what you expected, adjust detection level.

Note:

- Some pages may be incorrectly skipped as blank pages.*
- This feature is not available when scanning double-sided originals that are stitched.*

Automatic Feeding Mode:

Set Automatic Feeding Mode. This feature allows you to continue scanning automatically after the originals are scanned. This feature is useful when scanning different sizes or types of originals one by one.

Adjust the edge guides of the scanner before placing each original.

- On (Full-Auto):** Start scanning when an original is set while the continuation confirmation message is displayed.
- On (Semi-Auto):** Start scanning when the **Start Scanning** button is pressed while the continuation confirmation message is displayed.

Detect Double Feed:

Display a warning when multiple originals are fed at the same time.

- Ultrasonic sensor:** Detect a double feed using an ultrasonic sensor. You can specify the detection range.
- Length:** Detect a double feed by the length. When the length of the second original scanned is different from the first, this is identified as a double feed. You can specify the difference in length for detection.

File Name:

- Filename Prefix:**
Enter a prefix for the name of the images in alphanumeric characters and symbols.
- Add Date:**
Add the date to the file name.
- Add Time:**
Add the time to the file name.

Clear All Settings

Resets the scan settings to their defaults.

Scanning Using WSD

Note:

This feature is only available for computers running Windows Vista or later.

If a destination computer is not displayed, follow the steps below to add a WSD scan device.

[“Adding a WSD Scan Device” on page 95](#)

1. Place the originals.
2. Select **WSD** on the home screen of the scanner's control panel.
3. Select a destination.
4. Tap .
5. Follow the on-screen instructions when the **WSD Scan Device** screen is displayed on your computer.

Adding a WSD Scan Device

Depending on your environment, you may need to add a WSD scan device on your computer.

The following procedure is an example for Windows 10. The procedure may differ depending on your environment.

1. Display the device list.
Click the start button, and then select **Settings > Devices > Printers & scanners**.
2. Click **Add a printer or scanner**.
3. Select your scanner, and then click **Add device**.

Note:

If you do not know the device name of your scanner, you can check the name on the scanner's control panel.

*Select **Settings > Network Settings > Network Status** on the scanner's control panel, and then select the active connection method status to check the **Device Name**.*

The procedure is complete when the scanner is added to the list.

Note:

- You can change the WSD scan event. Click the scanner you added, and then click **Manage > Scanner properties > Properties > Events**.*
- You can add a WSD scan device from the Windows Control Panel.
Select **Control Panel > Hardware and Sound > View devices and printers**, and then click **Add a device**.*

Combinations for Available File Format and Image Type

You can select the following image types according to the feature being used and the File Format in which they will be saved.

Scan to Computer Feature

Depends on the Document Capture Pro settings.

Scan to USB Drive Feature, Scan to Network Folder/FTP Feature

✓ : Can be selected. - : Cannot be selected.

Image Type	File Format			
	JPEG	PDF (Single Page) PDF (Multi Page) PDF/A (Single Page) PDF/A (Multi Page)	TIFF (Single Page)	TIFF (Multi Page)
Color	✓	✓	✓	-
B&W	-	✓	✓	✓
Gray	✓	✓	✓	-
Color/ Grayscale/B&W	-	✓	✓	-
Color/Black & White	-	✓	✓	-
Color/Grayscale	✓	✓	✓	-

Scan to Cloud Feature

✓ : Can be selected. - : Cannot be selected.

Image Type	File Format			
	JPEG	PDF (Single Page) PDF (Multi Page)	TIFF (Single Page)	TIFF (Multi Page)
Color	✓	✓	-	-
B&W	-	✓	-	-
Gray	✓	✓	-	-
Color/ Grayscale/B&W	-	-	-	-
Color/Black & White	-	-	-	-
Color/Grayscale	✓	✓	-	-

Scan to Email Feature

✓ : Can be selected. - : Cannot be selected.

Image Type	File Format			
	JPEG	PDF (Single Page) PDF (Multi Page) PDF/A (Single Page) PDF/A (Multi Page)	TIFF (Single Page)	TIFF (Multi Page)
Color	✓	✓	-	-
B&W	-	✓	✓	✓
Gray	✓	✓	-	-
Color/ Grayscale/B&W	-	✓	-	-
Color/Black & White	-	✓	-	-
Color/Grayscale	✓	✓	-	-

Scanning Using Presets Settings

You can load the pre-configured **Presets** settings you want to use to scan.

- Use one of the following methods to load the **Presets**.
 - Select **Presets** on the home screen of the scanner's control panel, and then select the setting from the list.
 - Select  on the scanning menu, select **Load Presets**, and then select the setting from the list.
 - If you have added the **Presets** icon to the home screen, select the icon on the home screen.

Note:

*If you have enabled **Quick Send** in the preset settings, on the preset setting, scanning starts immediately.*

- If the loading confirmation screen is displayed, select **Close** to close the screen.
- Check the loaded **Presets** settings.
- Tap .

Related Information

➔ [“Registering Presets” on page 144](#)

Scanning from a Computer

Scanning Using Document Capture Pro (Windows)

Document Capture Pro allows you to easily and efficiently digitize originals and forms to suit your needs.

The following functions are available with Document Capture Pro.

- You can manage and perform a set of operations, such as scanning and saving, as a "job".
- You can configure a "job" to save scanned images in various formats (PDF/BMP/JPEG/JPEG2000/TIFF/Multi-TIFF/PNG/DOCX/XLSX/PPTX).
- You can sort jobs automatically by inserting dividing paper between the originals or by using barcode information on the originals.
- You can output scanning information or items necessary for the scanned content as index data.
- You can set multiple destinations.
- You can scan using simple operations without having to create a job.

By using these functions, you can digitize paper documents more efficiently, such as scanning a large number of documents or using them over a network.

Note:

- For detailed information on how to use Document Capture Pro, refer to the following URL:
<https://support.epson.net/dcp/>
- Document Capture Pro does not support Windows Server.

What is a Job Scan?

By registering a series of frequently used operations as a job, you can execute these operations by simply selecting the job.

By assigning a job to the control panel of a scanner, you can also execute the job from the control panel.

Performing a Job Scan

This section explains the workflow of scanning using an existing job.

1. Select the scanner you want to use from the Document Capture Pro top screen. When you start the software it automatically connects to the last scanner you used.

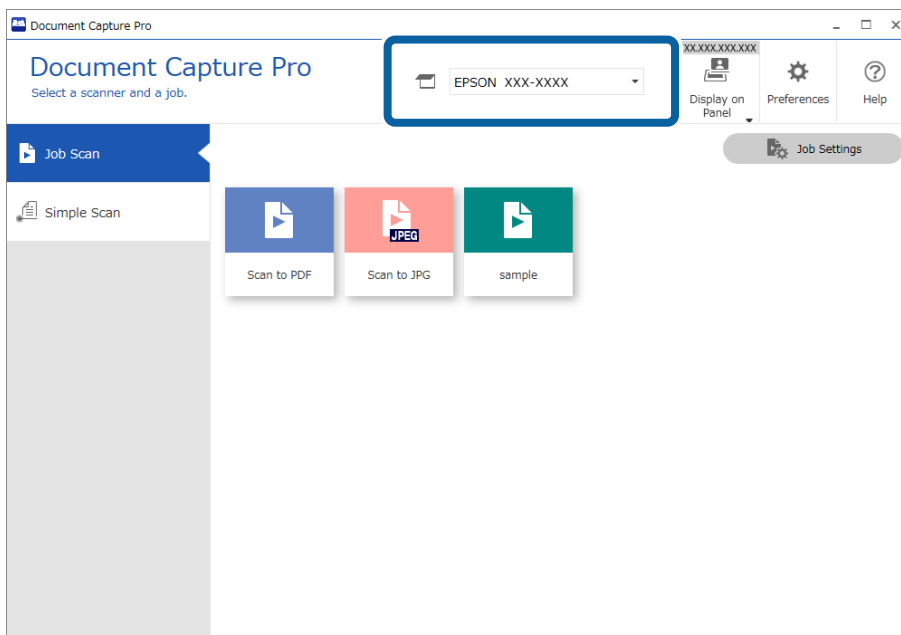

2. Click the **Job Scan** tab, and then click the icon of the job you want to perform.

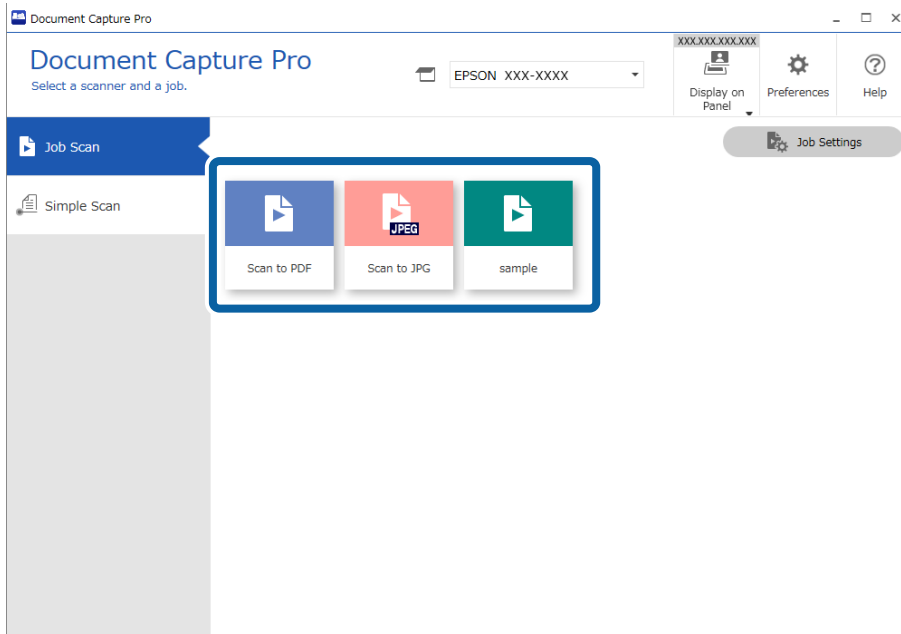

The selected job is performed.

When you perform a job for which **Show the preview while scanning** has been selected in the Scan Settings, a preview screen is displayed while scanning.

3. If you execute a job that contains the following elements in the File Name Settings, Separation Settings, or User-Defined Index Settings from Save Settings, and the elements are detected in the scanned page, the detection area is displayed on the image as a marquee. Correct the recognition results manually if necessary, or change the area and run the recognition again.
 - OCR
 - Barcode
 - Form
 - MRZ in passports

❑ MRZ in travel documents

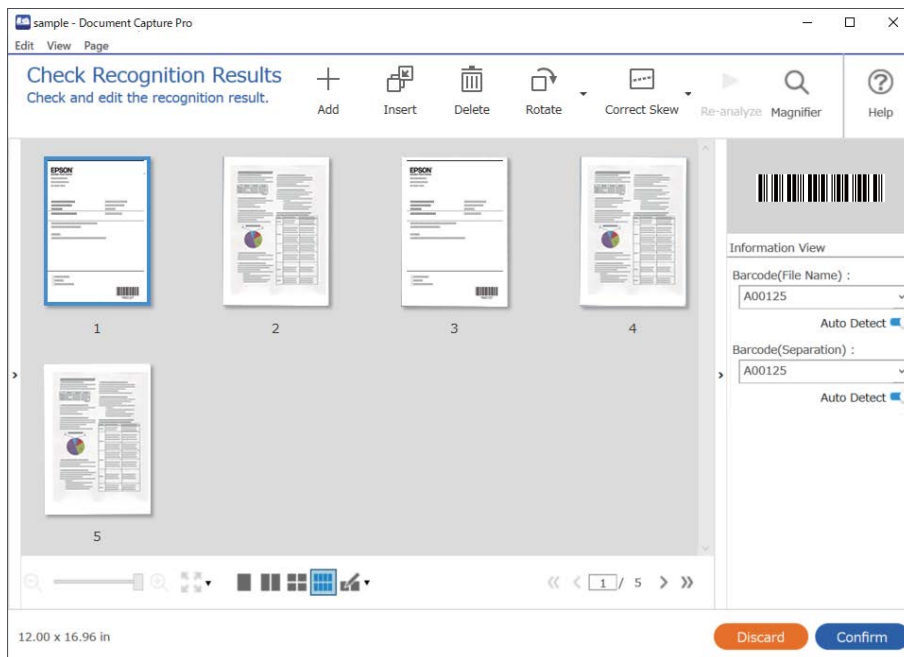

- For jobs for which **Show Edit Page dialog before saving** has been selected in the Scan Settings, check the scan results on the **Edit Scanned Results** screen after scanning, and then make edits as necessary.

You can check and edit the following on the **Edit Scanned Results** screen.

- ❑ Results of separation
- ❑ Scanned images
- ❑ Index data

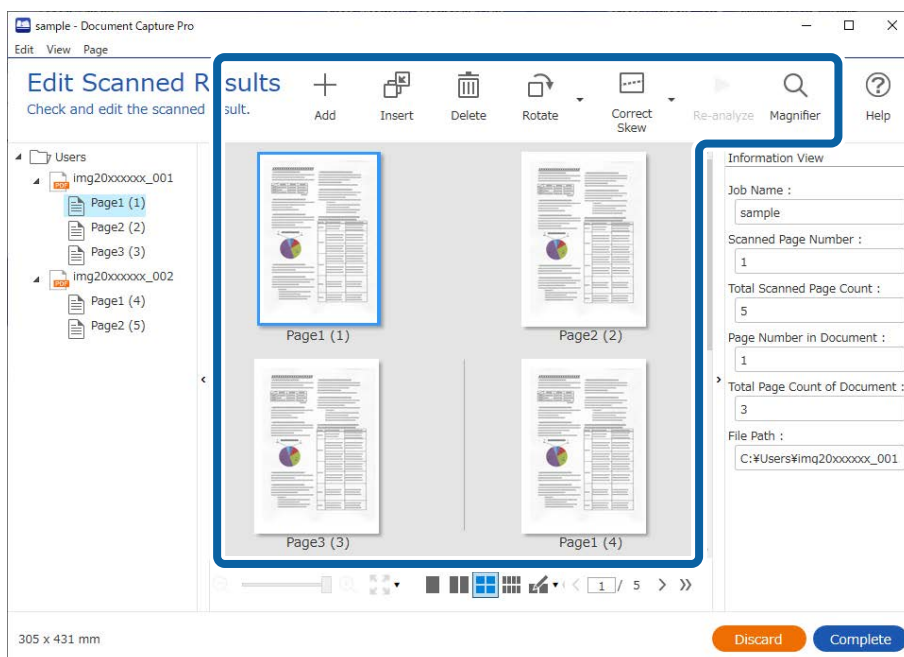

5. Click **Complete** to finish performing the Job Scan.

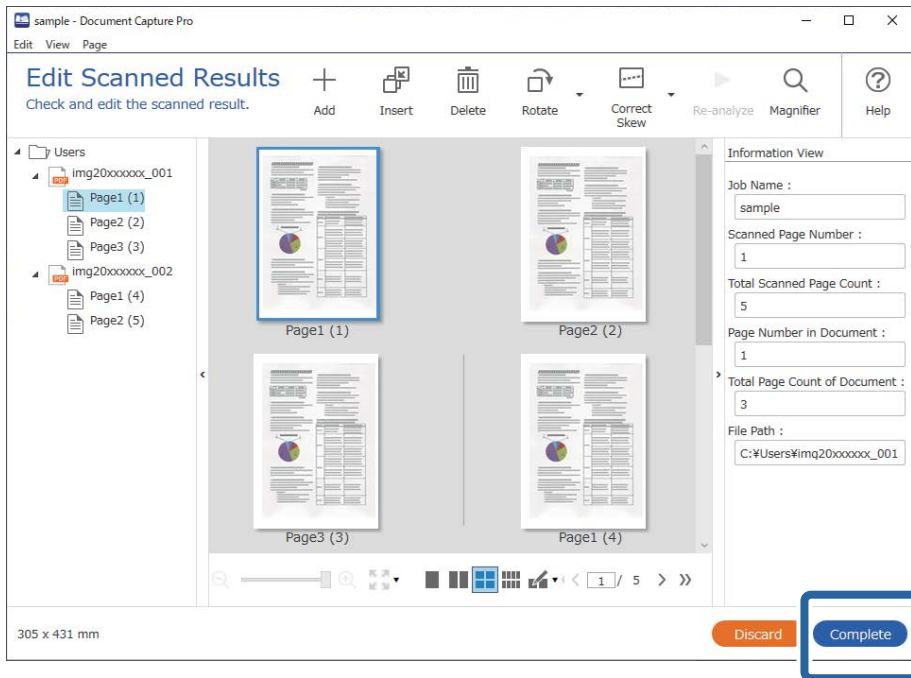

What is a Simple Scan?

You can scan documents without creating a job. Check the results after scanning, and then save or set the destination.

By assigning Simple Scan Settings to the control panel of a scanner, you can also execute the Simple Scan from the control panel.

Performing a Simple Scan

This section explains the workflow of scanning without using a job.

1. Select the scanner you want to use from the Document Capture Pro top screen. When you start the software it automatically connects to the last scanner you used.

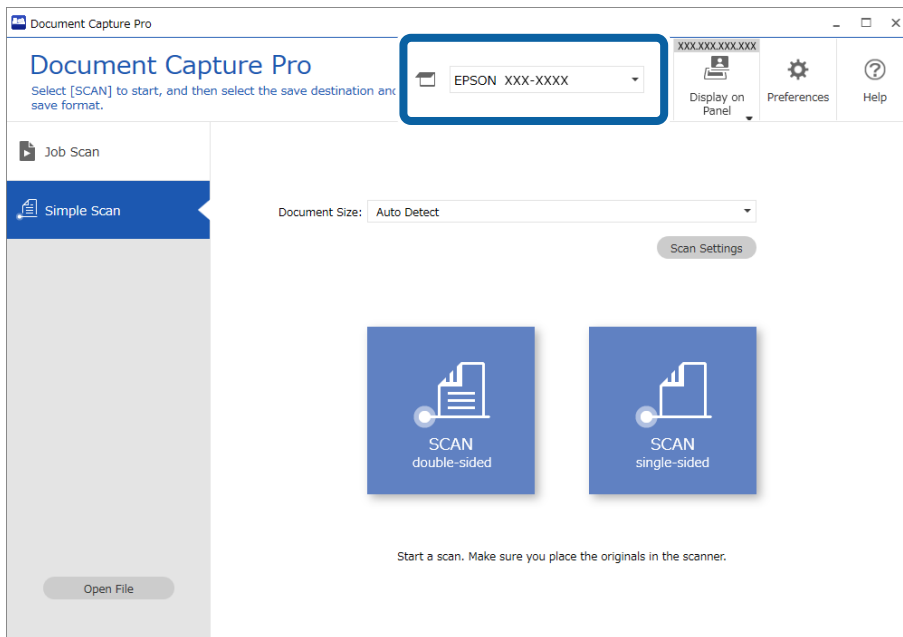

2. Click the **Simple Scan** tab, select **Document Size**, and then click the **SCANdouble-sided** or **SCANsingle-sided** icon.

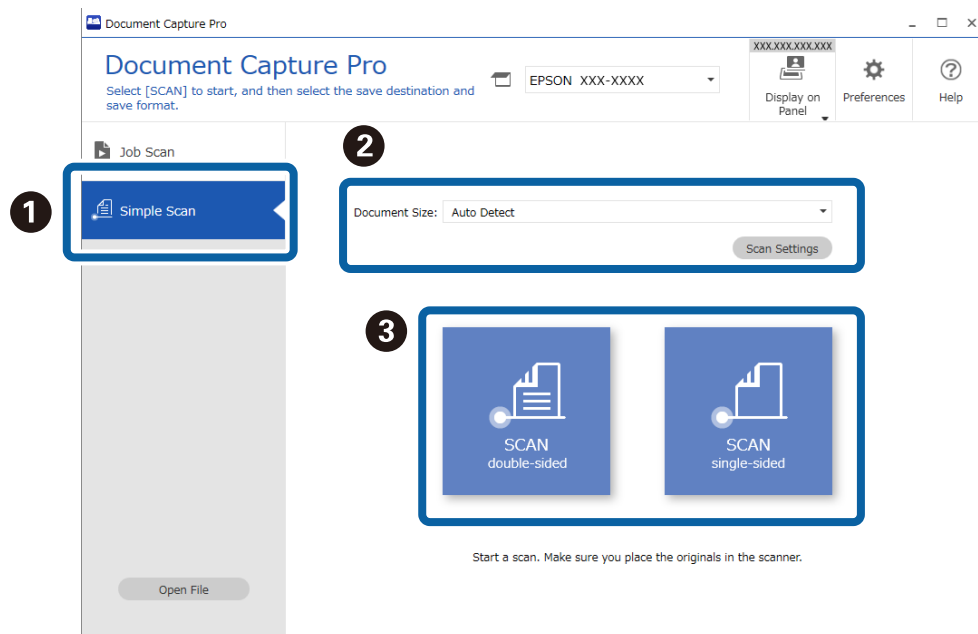

Note:

Click **Scan Settings** to set the resolution. You can make more detailed settings from Epson Scan 2.

The image being scanned is displayed.

3. Check the scan results on the **Edit Scanned Results** screen, make edits as necessary, and then click **Next**.

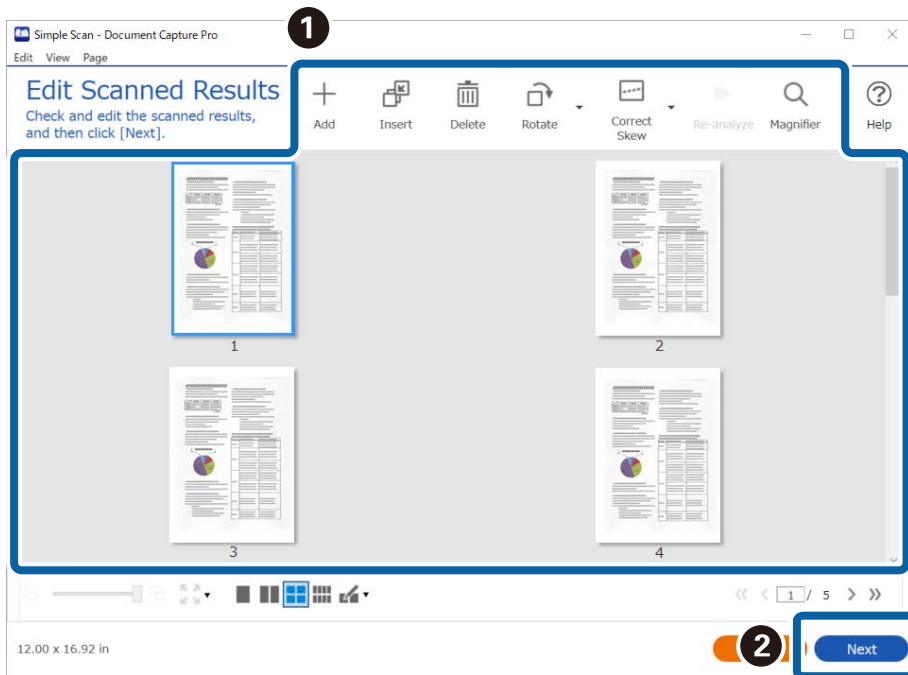

4. Select the destination for the scanned data on the **Select Destination** screen.

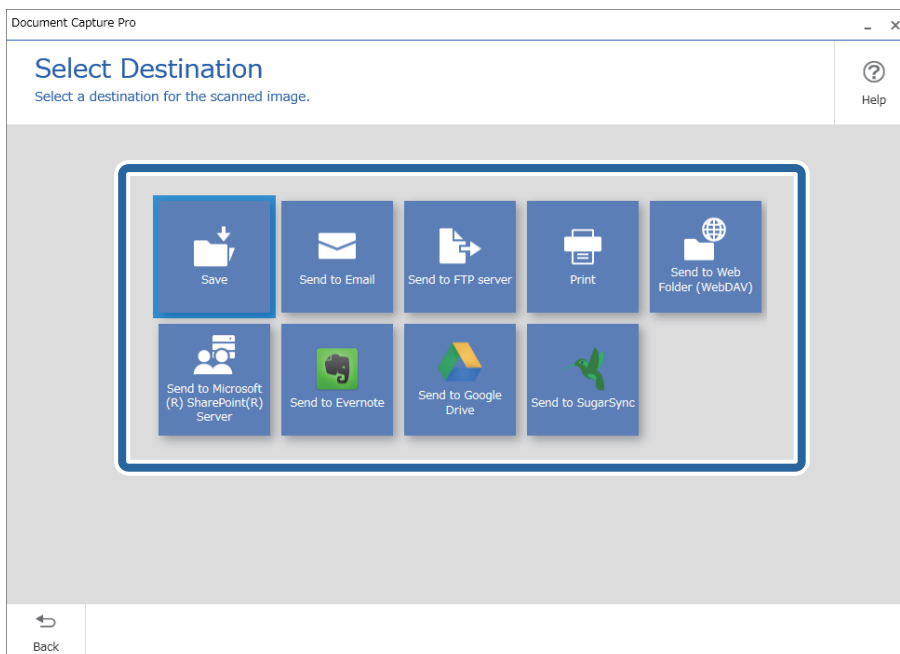

5. Set the file you want to save and the save format on the **Destination Settings** screen. You can also make more detailed settings according to the destination.

Displayed items depend on the destination. The following screen is displayed when **Save** is selected.

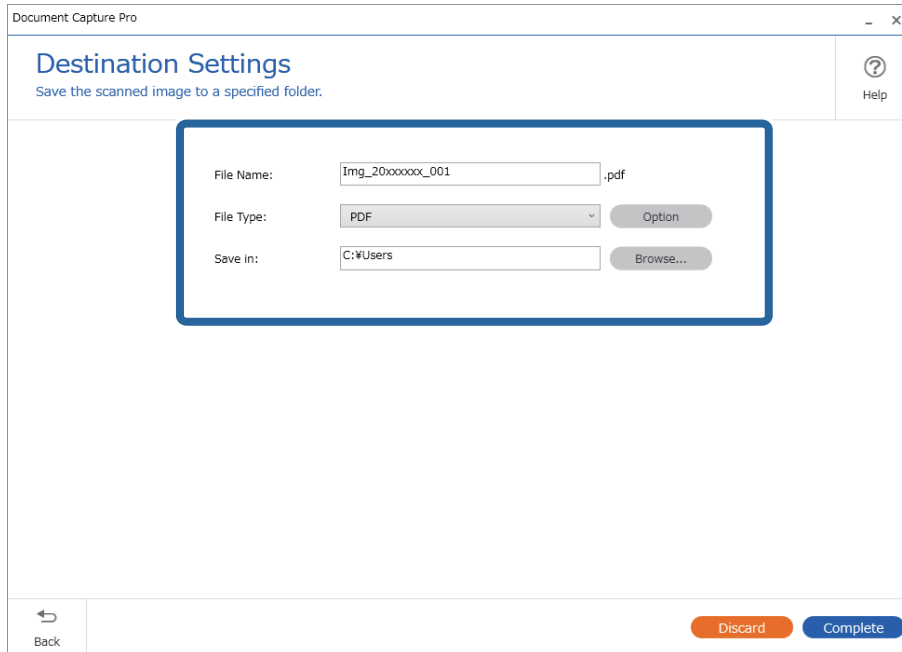

6. Click **Complete** to finish performing the Simple Scan.

Scanning Using Document Capture (Mac OS)

This application allows you to perform various tasks such as saving the image to your computer, sending it by email, printing, and uploading to a server or a cloud service. You can also register scanning settings for a job to simplify scanning operations.

See the Document Capture help for details on the features.

Note:

Do not use the Fast User Switching function while using your scanner.

1. Start Document Capture.

Select **Finder > Go > Applications > Epson Software > Document Capture**.

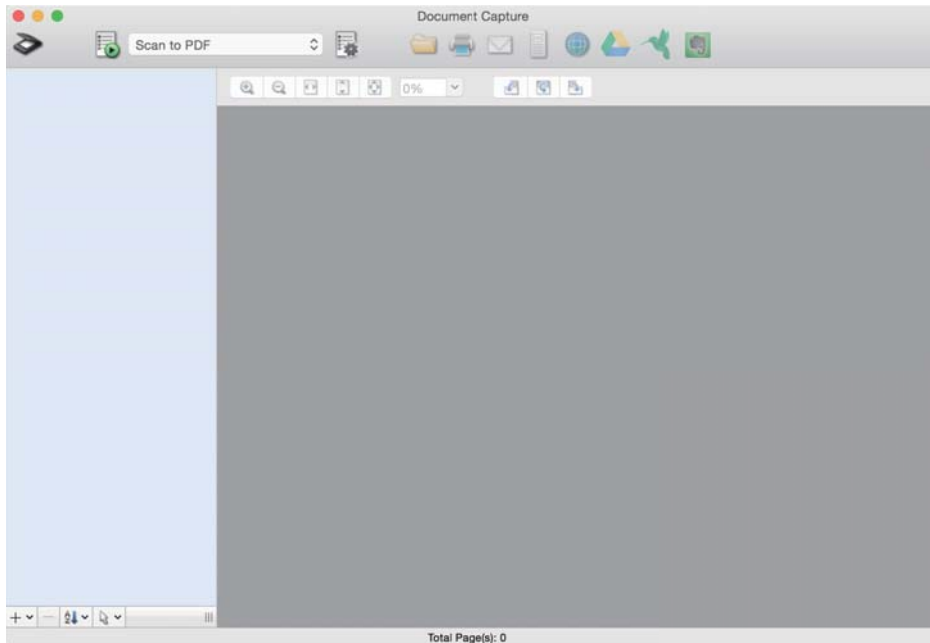

Note:

You may need to select the scanner you want to use from the scanners list.

2. Click .

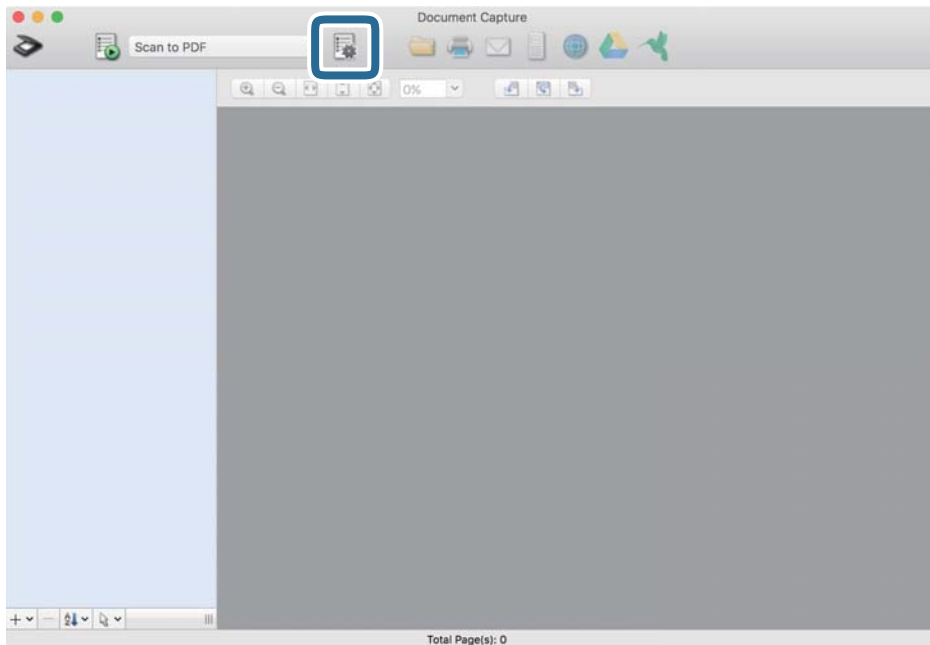

The **Job List** screen is displayed.

Note:

A preset job is available that allows you to save scanned images as a PDF. When using this job, skip this procedure and go to procedure 10.

3. Click the + icon.

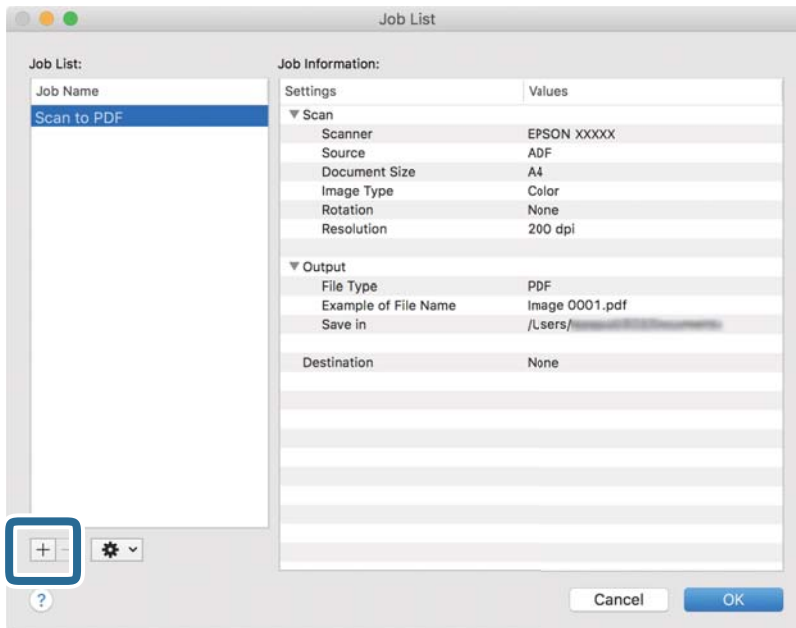

The job setting screen is displayed.

4. Set the **Job Name**.

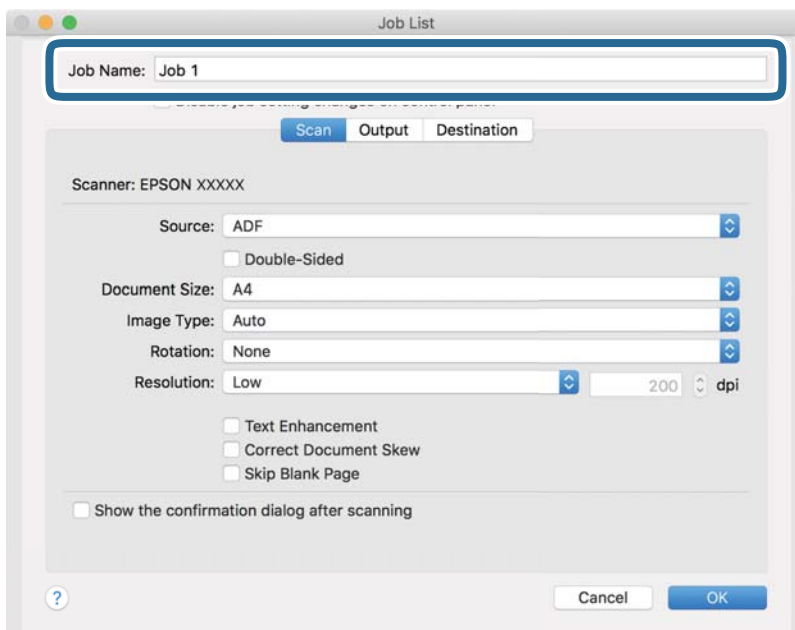

5. Make scanning settings on the **Scan** tab.

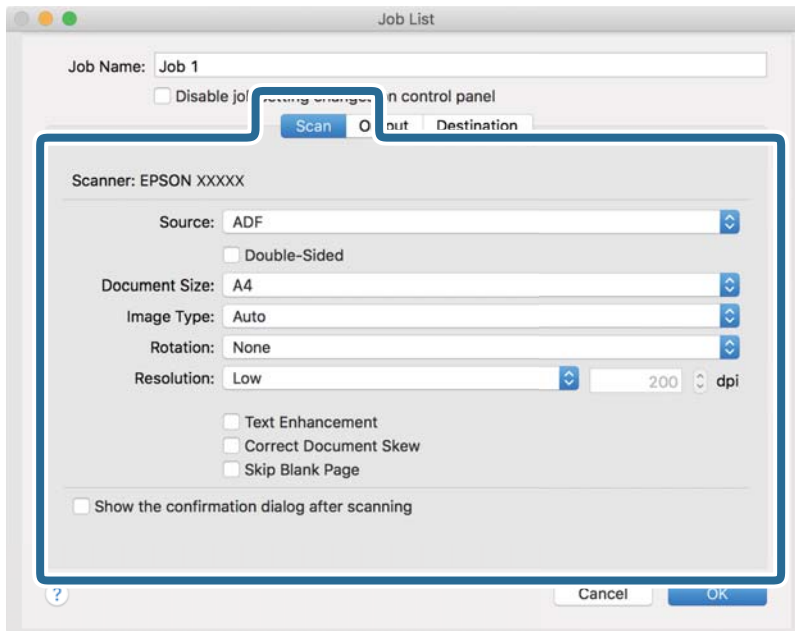

- Source:** Select the source where the original is placed. Select double-sided to scan both sides of the originals.
- Document Size:** Select the size of the original you placed.
- Image Type:** Select the color you want to use to save the scanned image.
- Rotation:** Select the rotation angle depending on the original you want to scan.
- Resolution:** Select the resolution.

Note:

You can also adjust the image using following items.

- Text Enhancement:** Select to make blurred letters in the original clear and sharp.
- Correct Document Skew:** Select to correct the slant of the original.
- Skip Blank Page:** Select to skip blank pages if there are any in the originals.

6. Click **Output**, and then make the output settings.

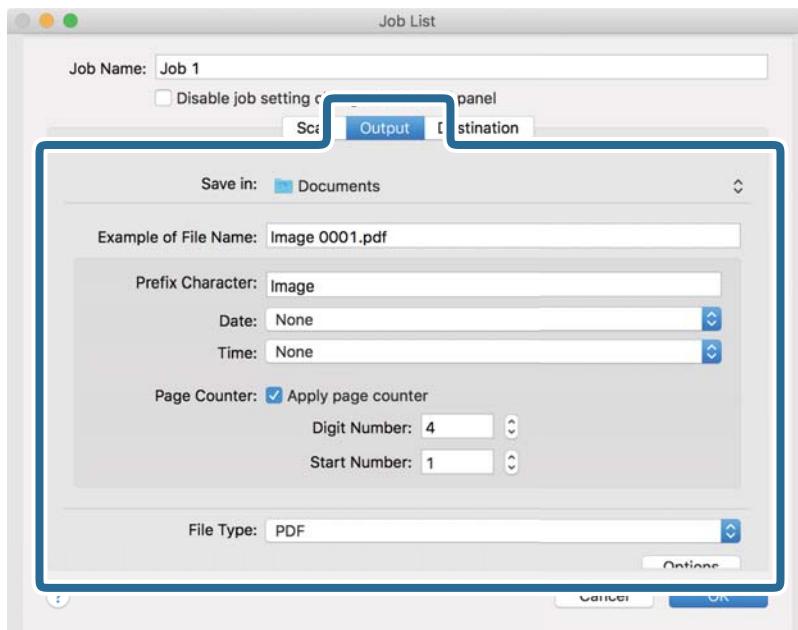

- Save in:** Select the save folder for the scanned image.
- Example of File Name:** Display an example of the file name for the current settings.
- Prefix Character:** Set a prefix for the file name.
- Date:** Add the date to the file name.
- Time:** Add the time to the file name.
- Page Counter:** Add the page counter to the file name.
- File Type:** Select the save format from the list. Click **Options** to make detailed settings for the file.

7. Click **Destination**, and then select the **Destination**.

Destination setting items are displayed according to the destination you selected. Make detailed settings as necessary. Click the ? (Help) icon for details on each item.

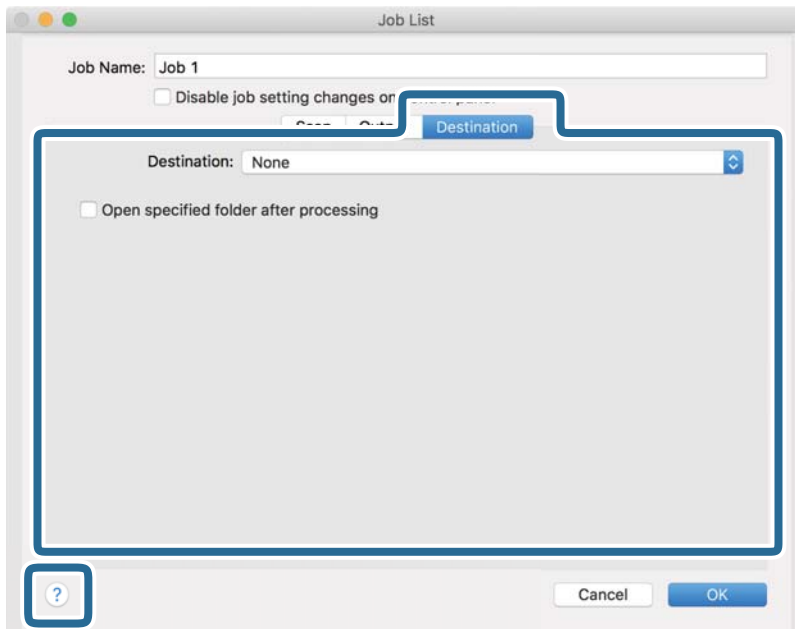

Note:

- If you want to upload to a cloud service, you need to set up your account with the cloud service in advance.
- If you want to use Evernote as the destination, download the Evernote application from the Evernote Corporation Website and install it before using this feature.

8. Click **OK** to close the job settings screen.
9. Click **OK** to close the **Job List** screen.
10. Place the original.

11. Select the job from the pull down list, and then click the  icon.

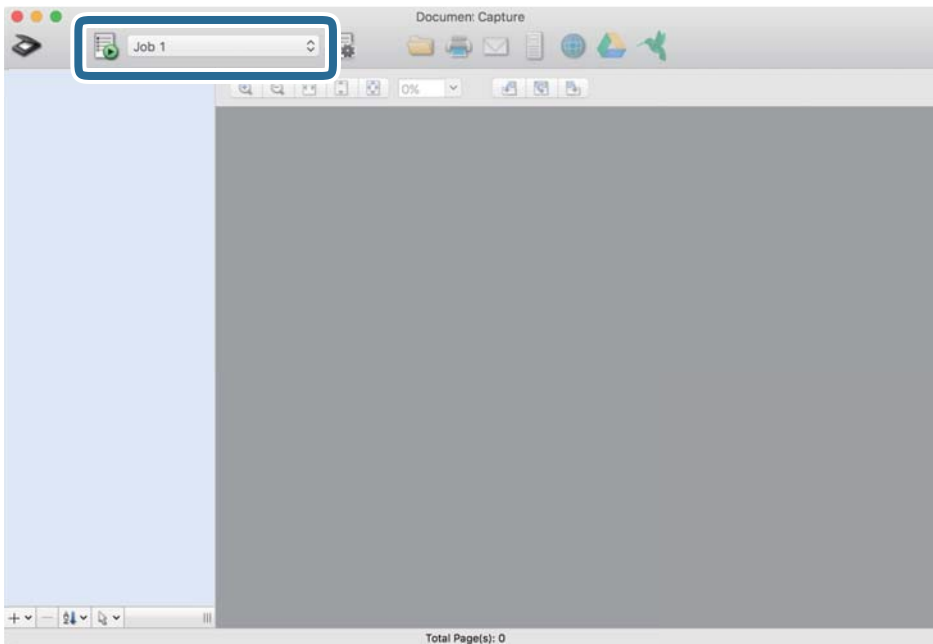

The selected job is performed.

12. Follow the on-screen instructions.

The scanned image is saved using the settings you made for the job.

Note:

You can scan the originals and send the scanned image without using the job. Click  and make scanning settings, and then click **Preview Scan**. Next, click the destination to which you want to send the scanned image.

Scanning Using Epson Scan 2

You can scan the originals using detailed settings that are suitable for text documents.

1. Place the original.
2. Start Epson Scan 2.
 - Windows 11
Click the start button, and then select **All apps > EPSON > Epson Scan 2**.
 - Windows 10/Windows Server 2022/Windows Server 2019/Windows Server 2016
Click the start button, and then select **EPSON > Epson Scan 2**.
 - Windows 8.1/Windows 8/Windows Server 2012 R2/Windows Server 2012
Enter the application name in the search charm, and then select the displayed icon.
 - Windows 7/Windows Server 2008 R2/Windows Server 2008
Click the start button, and then select **All Programs or Programs > EPSON > Epson Scan 2 > Epson Scan 2**.

❑ Mac OS

Select **Go > Applications > Epson Software > Epson Scan 2**.

3. Make the following settings on the **Main Settings** tab.

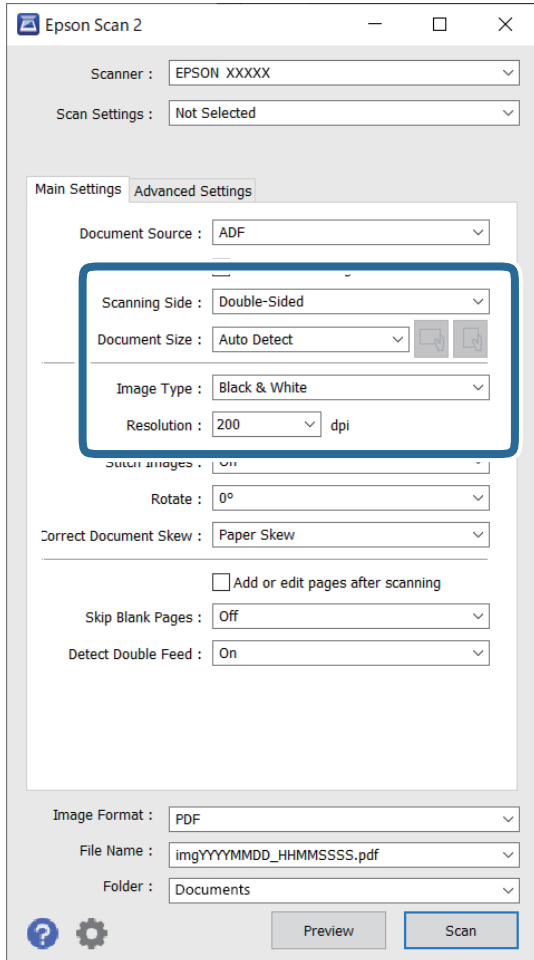

- ❑ **Scanning Side:** Select the side of the original you want to scan. Select **Double-Sided** to scan both sides of the originals.
- ❑ **Document Size:** Select the size of the original you placed.
- ❑  (Original orientation) buttons: Select the set orientation of the original you placed. Depending on the size of the original, this item may be set automatically and cannot be changed.
- ❑ **Image Type:** Select the color for saving the scanned image.
- ❑ **Resolution:** Select the resolution.

Note:

- ADF is set as the **Document Source** automatically.*
- On the **Main Settings** tab, you can also make the following settings.*
 - Stitch Images:** Select to stitch the images on the front and rear when scanning both sides of the original.
 - Rotate:** Select to rotate the original clockwise and scan it.
 - Correct Document Skew:** Select to correct the slant of the original.
 - Add or edit pages after scanning:** Select to add different originals or edit (rotate, move, and delete) the scanned pages after scanning.
 - Skip Blank Pages:** Select to skip blank pages if there are any in the originals.
 - Detect Double Feed:** Select to display a warning when multiple originals are fed at the same time.

4. Make other scan settings if necessary.

- You can preview the scanned image of the first side of the first page of the originals. Load only the first page of your originals into the input tray and click the **Preview** button. The preview window opens, the previewed image is displayed, and the page is ejected from the scanner.
Replace the ejected page together with the rest of the originals.
- On the **Advanced Settings** tab, you can make image adjustments using detailed settings which are suitable for text documents, such as the following.
 - Remove Background:** Select to remove the background from the originals.
 - Text Enhancement:** Select to make blurred letters in the original clear and sharp.
 - Auto Area Segmentation:** Select to make letters clear and images smooth when performing black and white scanning for a document that contains images.
 - Dropout:** Select to remove the color specified from the scanned image, and then save it in grayscale or black and white. For example, you can erase marks or notes you wrote in the margins with color pen when scanning.
 - Color Enhance:** Select to enhance the color specified for the scanned image, and then save it in grayscale or black and white. For example, you can enhance letters or lines that are in light colors.

Note:

Some items may not be available depending on other settings you made.

5. Set the file saving settings.

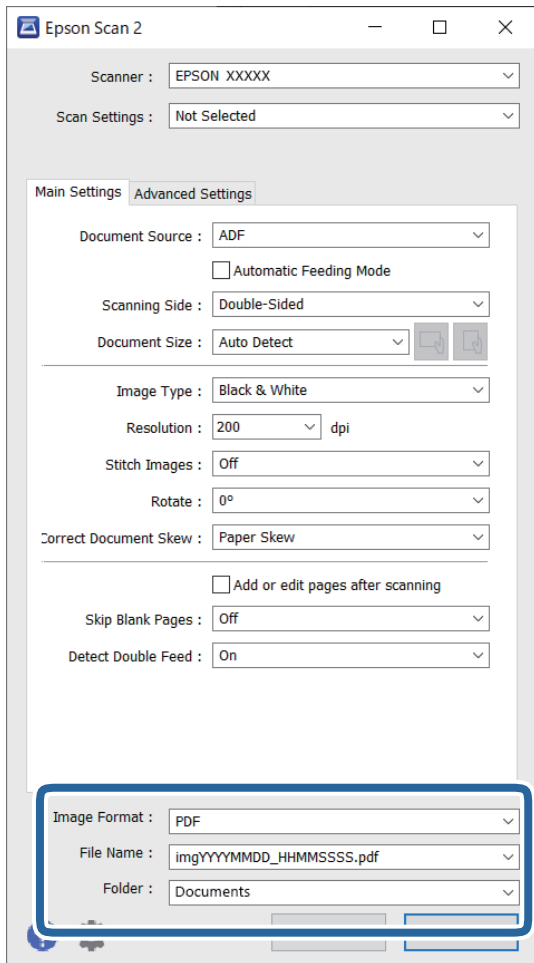

- ❑ **Image Format:** Select the save format from the list.

You can make detailed settings for each save format except BITMAP and PNG. After selecting the save format, select **Options** from the list.

- ❑ **File Name:** Check the save file name displayed.

You can change settings for file name by selecting **Settings** from the list.

- ❑ **Folder:** Select the save folder for the scanned image from the list.

You can select other folder or create a new folder by selecting **Select** from the list.

6. Click **Scan**.

Note:

- ❑ You can also start scanning by pressing the  button on the scanner's control panel.
- ❑ To scan originals that are likely to jam, for example thin paper, enable **Slow** on the control panel to slow down the scanning speed.

The scanned image is saved to the folder you specified.

Required Settings for Special Originals in Epson Scan 2 Window

You need to set certain items on the **Main Settings** tab in Epson Scan 2 window when scanning special originals.

When you are using Document Capture Pro, you can open the window by pressing the **Detailed Settings** button on the **Scan Settings** screen.

Type of Original	Required Settings
Envelopes	Select Off in Detect Double Feed .
Plastic cards	Select Plastic Card on the Document Size list, or select Off in Detect Double Feed .
Carrier Sheet	<input type="checkbox"/> If you select Auto Detect from the Document Size list, paper skew in the original is automatically corrected even if you select Off in Correct Document Skew . <input type="checkbox"/> If you select a other size than Auto Detect from the Document Size list, you can only use Contents Skew when using Correct Document Skew . Paper Skew is not applied when this is selected. When you select Paper and Contents Skew , only contents skew is corrected.
Large size originals	If the size of the original you want to scan is not on the Document Size list, select Customize to create the size manually on the window.
Long paper	If the size is not listed on the Document Size list, select Auto Detect (Long Paper) or select Customize to create a custom document size.
Laminated cards	To scan transparent areas around the edges, select Settings on the Document Size list to open the Document Size Settings window. Next, select Scan laminated card in the window. <i>Note:</i> <i>The appropriate effect may not be achieved depending on the original. If transparent areas around the edges are not scanned, select Customize from the Document Size list, and then create the size manually.</i>

Setting a Resolution That Suits the Scanning Purpose

Advantages and Disadvantages of Increasing the Resolution

Resolution indicates the number of pixels (smallest area of an image) for each inch (25.4 mm), and is measured in dpi (dots per inch). The advantage of increasing the resolution is that the details in the image become fine. The disadvantage is that the file size becomes large.

- File size becomes large
(When you double the resolution, the file size becomes about four times larger.)
- Scanning, saving, and reading the image takes a long time
- Sending and receiving emails or faxes takes a long time
- The image becomes too large to fit the display or print on the paper

List of Recommended Resolutions to Suit Your Purpose

See the table and set the appropriate resolution for the purpose of your scanned image.

Purpose	Resolution (Reference)
Displaying on a screen Sending by email	Up to 200 dpi

Purpose	Resolution (Reference)
Using Optical Character Recognition (OCR) Creating a text searchable PDF	200 to 300 dpi
Printing using a printer Sending by fax	200 to 300 dpi

Software Image Quality Adjustment Features

The Epson Scan 2 (scanner driver) feature allows you to adjust the image quality when scanning. When you are using Document Capture Pro, you can open the Epson Scan 2 window by clicking the **Detailed Settings** button on the scan settings screen.

You can adjust the image quality of the scanned images using the features on the **Advanced Settings** tab. For more details on each feature, see the help on the screen displayed.

Note:

Some items may not be available depending on other settings you made.

Scanning from a Computer Using a Scanner with Access Control Enabled

When the access control function is enabled for a scanner, you need to register a User Name and Password when scanning using Epson Scan 2. Contact your administrator if you do not know the password.

1. Start Epson Scan 2.
2. On the Epson Scan 2 screen, make sure that your scanner is selected in the **Scanner** list.
3. Select **Settings** from **Scanner** to open the **Scanner Settings** screen.
4. Click **Access Control**.
5. On the **Access Control** screen, enter the **User Name** and the **Password** for an account that has permission to scan.
6. Click **OK**.

Using AirPrint

AirPrint enables instant scanning from a Mac without the need to install drivers or download software.



1. Load your originals.
2. Connect the product to the same network that your Mac is connected to, or connect the product to your Mac with a USB cable.

3. On the **System Preferences** screen on your Mac, click **Printers & Scanners**.
4. Select your scanner from the list, then click **Open Scanner**.
5. Select scan settings as needed, then start scanning.

Note:

For details, see the *macOS User Guide*.

Scanning Using Chromebook

You can scan using a Chromebook.

1. Place the originals.
2. Connect the scanner to the network that your Chromebook is connected to, or connect the scanner to your Chromebook using a USB cable.
3. Open the Scan app on your Chromebook.
Select the time in the bottom-right of the screen > **Settings** button > **Advanced** > **Print and scan** > **Scan**.
4. Select your scanner, and then set other items if necessary.
5. Scan from your Chromebook with your scanner.

Note:

For more details, check <https://www.google.com/chromebook/>.

Setting a Job

You can register a set of operations, such as Scan-Save-Send, as a "job".

By registering a series of operations in advance as a job using Document Capture Pro (Windows) or Document Capture (Mac OS), you can perform all of the operations by simply selecting the job.

Note:

You can set the registered job as **Presets** on the scanner's control panel. This is available only for computers connected over a network.

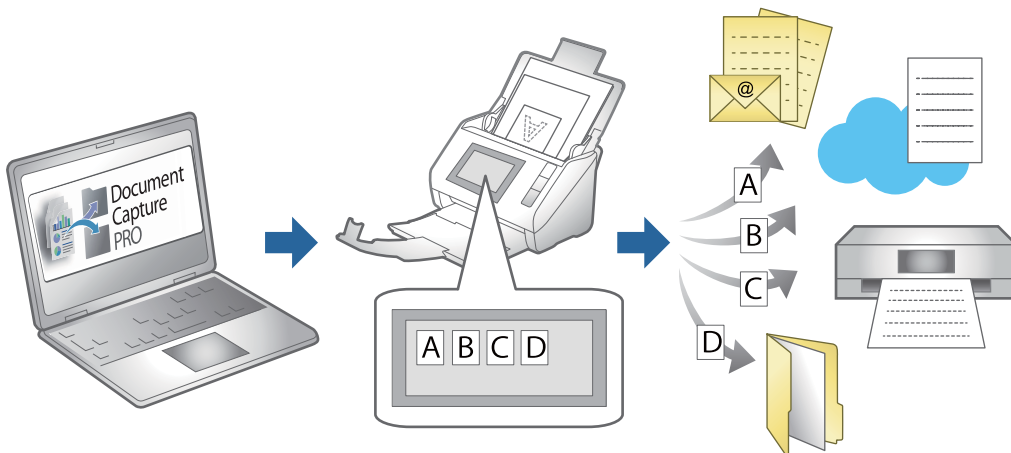

Creating a Job and Assigning a Job to the Control Panel (Windows)

See the Document Capture Pro manual for details. Access the URL below to view the latest manual.

<https://support.epson.net/dcp/>

Note:

There is a preset job that saves scanned images as PDFs.

Related Information

➔ [“Scanning Originals to a Computer” on page 77](#)



Creating and Registering a Job (Mac OS)

Explains how to set a job in Document Capture. See the Document Capture help for details on the features.

1. Start Document Capture.
2. Click the  icon on the main window.
The **Job List** window is displayed.
3. Click the + icon.
The **Job Settings** window is displayed.
4. Make the job settings on the **Job Settings** window.
 - Job Name:** Enter the name of the job you want to register.
 - Scan:** Make scan settings such as the size of the originals or the resolution.
 - Output:** Set the saving destination, the saving format, the naming rules of the files, and so on.
 - Destination:** Select the destination of the scanned images. You can send them by email or forward them to an FTP server or Web server.
5. Click **OK** to return to the **Job List** window.
The created job is registered in the **Job List**.
6. Click **OK** to return to the main window.

Assigning a Job to the Control Panel (Mac OS)

Explains how to assign a job to the scanner's control panel in Document Capture. See the Document Capture help for details on the features.

1. Start Document Capture.
2. Click the  icon on the main window.
The **Job List** window is displayed.
3. Click the  icon and select **Event Settings**.

4. Select the job you want to run on the control panel from the pull-down menu.
5. Click **OK** to return to the **Job List** window.
The job is assigned to the scanner's control panel.
6. Click **OK** to return to the main window.

Related Information

➔ [“Scanning Originals to a Computer” on page 77](#)

Scanning in Automatic Feeding Mode

In Automatic Feeding Mode, scanning starts automatically when originals are loaded into the ADF. This is useful when you want to scan originals one by one, or add originals to the current scanning process.

When you are using Document Capture Pro, you can also use Automatic Feeding Mode.

1. Start Epson Scan 2.

Note:

*When you are using Document Capture Pro, you can open the Epson Scan 2 window by pressing the **Detailed Settings** button on the scan settings screen.*

2. Select **Automatic Feeding Mode** on the **Main Settings** tab.

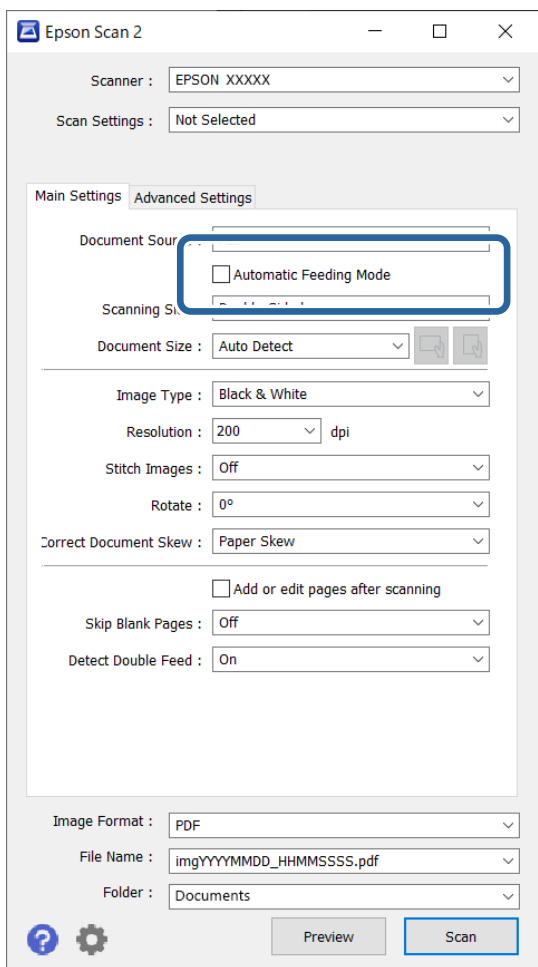

3. Make other settings for scanning in the Epson Scan 2 main window.
4. Click **Scan**.

Note:

When you are using Document Capture Pro, click **Save** to save the scan settings. When you start scanning, Automatic Feeding Mode starts.

Automatic Feeding Mode starts.

The **Automatic Feeding Mode** window is displayed on your computer and the scanner.

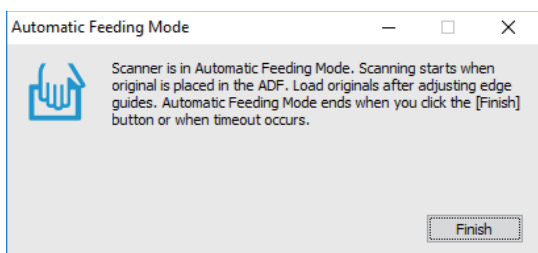

5. Adjust the edge guides, and then place the original in the ADF.
Scanning starts automatically.

6. After scanning stops, place the next original in the ADF.

Repeat this procedure until you have scanned all originals.

Note:

You can set **Scanner Settings** on the scanner's control panel.

- **Slow:** Slows down the scanning speed. Use this to scan originals that are likely to jam, for example thin paper.
- **Double Feed Stop Timing:** Set the operation when any double feed is detect.
- **DFDS Function:** Skips double feed detection once and continues scanning. Use this to scan originals that are detected as double feeds, for example plastic cards or envelopes.
- **Paper Protection:** Reduces damage to the originals by stopping scanning immediately when a feeding error occurs.
- **Glass Dirt Detection:** Detects dirt on the glass surface inside the scanner.

7. After you have scanned all originals, close Automatic Feeding Mode.

Select **Done** on the scanner's control panel or press **Finish** on the **Automatic Feeding Mode** screen displayed on your computer.

Note:

You can make timeout settings to exit **Automatic Feeding Mode**.

Select **Settings** on the **Document Source** list to open the **Document Source Settings** screen. Set the timeout time on the screen displayed.

The scanned image is saved to the folder you specified.

Related Information

- ➔ [“Placing Originals” on page 47](#)

Scanning from a Smart Device

Scanning Using Epson Smart Panel

To scan from your smart device, search for and install Epson Smart Panel from App Store or Google Play.

Note:

Connect the scanner to the smart device before scanning.

1. Place the original.
2. Start Epson Smart Panel.
3. Follow the on-screen instructions to scan.

Note:

If the size of your original does not appear in the list, select **Auto**.

The scanned image is saved to your smart device, send to cloud service, or send to email.

Scanning Using Mopria Scan

Mopria Scan enables instant network scanning from Android smart phones or tablets.



1. Install Mopria Scan from Google Play.
2. Place the originals.
3. Set up your scanner for network scanning. See the link below.
<https://epson.sn>
4. Connect your Android device over a wireless connection (Wi-Fi) to the same network that your scanner is using.
5. Scan from your device with your scanner.

Note:

For more details, access the Mopria Web site at <https://mopria.org>.

Required Settings for Scanning

Connecting the Scanner to the Network.	123
Registering an Email Server.	123
Creating a Network Folder.	126
Making Contacts Available.	132
Setting Up AirPrint.	141

Connecting the Scanner to the Network

If the scanner is not connected to the network, use the installer to connect the scanner to the network.

To start the installer, access the following website, and then enter the product name. Go to **Setup**, and then start setting up.

<https://epson.sn>

You can view the operating instructions in the Web Movie Manuals. Access the following URL.

<https://support.epson.net/publist/vlink.php?code=NPD7509>

Related Information

➔ [“Checking the Network Connection Status” on page 211](#)

Registering an Email Server

Check the following before configuring the email server.

- The scanner is connected to the network
- Setup information for email server

When you are using an Internet based email server, check the setting information from the provider or website.

How to Register

Access Web Config, select the **Network** tab > **Email Server** > **Basic**.

[“How to Run Web Config in a Web Browser” on page 34](#)

You can also make settings on the scanner's control panel. Select **Settings** > **Network Settings** > **Advanced** > **Email Server** > **Server Settings**.

Email Server Setting Items

Item	Settings and Explanation	
Authentication Method	Specify the authentication method for the scanner to access the mail server.	
	Off	Authentication is disabled when communicating with a mail server.
	SMTP AUTH	The email server needs to support SMTP authentication.
	POP before SMTP	When you select this item, set a POP3 server.
Authenticated Account	If you select SMTP AUTH or POP before SMTP as the Authentication Method , enter the authenticated account name. Enter within 0 to 255 characters in ASCII (0x20 - 0x7E).	
Authenticated Password	If you select SMTP AUTH or POP before SMTP as the Authentication Method , enter the authenticated password. Enter between 0 and 20 characters in ASCII (0x20-0x7E).	
Sender's Email Address	Set the email address that will be used to send emails from the scanner. Although you can use an existing email address, we recommend that you acquire and set up a dedicated email address so that it can be distinguished from emails sent from the scanner. Enter within 0 to 255 characters in ASCII (0x20 - 0x7E) except for : () < > [] ; ¥. A period "." cannot be the first character.	

Item	Settings and Explanation	
SMTP Server Address	Enter between 0 and 255 characters using A-Z a-z 0-9 . - . You can use IPv4 or FQDN format.	
SMTP Server Port Number	Enter a number between 1 and 65535.	
Secure Connection	Specify the secure connection method for the email server.	
	None	If you select POP before SMTP in Authentication Method , the connection method is set to None .
	SSL/TLS	This is available when Authentication Method is set to Off or SMTP AUTH .
	STARTTLS	This is available when Authentication Method is set to Off or SMTP AUTH .
Certificate Validation (Web Config only)	The certificate is validated when this is enabled. We recommend setting this to Enable when Secure Connection is set to anything other than None .	
POP3 Server Address	If you select POP before SMTP as the Authentication Method , enter the server address of the POP3 server. You can enter between 0 and 255 characters using A-Z a-z 0-9. You can use IPv4 or FQDN format.	
POP3 Server Port Number	Set when you select POP before SMTP in Authentication Method . Enter a number between 1 and 65535.	

Checking an Email Server Connection

1. Select the connection test menu.

When setting up from Web Config:

Select the **Network** tab > **Email Server** > **Connection Test** > **Start**.

When setting from the control panel:

Select **Settings** > **Network Settings** > **Advanced** > **Email Server** > **Connection Check**.

The connection test to the mail server is started.

2. Check the test results.

The test is successful when the message **Connection test was successful.** is displayed.

If an error is displayed, follow the instructions in the message to clear the error.

[“Mail Server Connection Test References” on page 124](#)

Mail Server Connection Test References

Message	Cause
SMTP server communication error. Check the following. - Network Settings	This message appears when <ul style="list-style-type: none"> <input type="checkbox"/> The scanner is not connected to a network <input type="checkbox"/> SMTP server is down <input type="checkbox"/> Network connection is disconnected while communicating <input type="checkbox"/> Received incomplete data

Message	Cause
POP3 server communication error. Check the following. - Network Settings	This message appears when <ul style="list-style-type: none"> <input type="checkbox"/> The scanner is not connected to a network <input type="checkbox"/> POP3 server is down <input type="checkbox"/> Network connection is disconnected while communicating <input type="checkbox"/> Received incomplete data
An error occurred while connecting to SMTP server. Check the followings. - SMTP Server Address - DNS Server	This message appears when <ul style="list-style-type: none"> <input type="checkbox"/> Connecting to a DNS server failed <input type="checkbox"/> Name resolution for an SMTP server failed
An error occurred while connecting to POP3 server. Check the followings. - POP3 Server Address - DNS Server	This message appears when <ul style="list-style-type: none"> <input type="checkbox"/> Connecting to a DNS server failed <input type="checkbox"/> Name resolution for a POP3 server failed
SMTP server authentication error. Check the followings. - Authentication Method - Authenticated Account - Authenticated Password	This message appears when SMTP server authentication failed.
POP3 server authentication error. Check the followings. - Authentication Method - Authenticated Account - Authenticated Password	This message appears when POP3 server authentication failed.
Unsupported communication method. Check the followings. - SMTP Server Address - SMTP Server Port Number	This message appears when you try to communicate with unsupported protocols.
Connection to SMTP server failed. Change Secure Connection to None.	This message appears when an SMTP mismatch occurs between a server and a client, or when the server does not support SMTP secure connection (SSL connection).
Connection to SMTP server failed. Change Secure Connection to SSL/TLS.	This message appears when an SMTP mismatch occurs between a server and a client, or when the server requests to use an SSL/TLS connection for an SMTP secure connection.
Connection to SMTP server failed. Change Secure Connection to STARTTLS.	This message appears when an SMTP mismatch occurs between a server and a client, or when the server requests to use a STARTTLS connection for an SMTP secure connection.
The connection is untrusted. Check the following. - Date and Time	This message appears when the scanner's date and time setting is incorrect or the certificate has expired.
The connection is untrusted. Check the following. - CA Certificate	This message appears when the scanner does not have a root certificate corresponding to the server or a CA Certificate has not been imported.
The connection is not secured.	This message appears when the obtained certificate is damaged.
SMTP server authentication failed. Change Authentication Method to SMTP-AUTH.	This message appears when an authentication method mismatch occurs between a server and a client. The server supports SMTP AUTH.
SMTP server authentication failed. Change Authentication Method to POP before SMTP.	This message appears when an authentication method mismatch occurs between a server and a client. The server does not support SMTP AUTH.

Message	Cause
Sender's Email Address is incorrect. Change to the email address for your email service.	This message appears when the specified sender's Email address is wrong.
Cannot access the product until processing is complete.	This message appears when the scanner is busy.

Creating a Network Folder

Create a network folder on your computer. The computer must be connected to the same network as the scanner.

The method to set the network folder varies depending on the environment. This is an example of creating a network folder on the desktop of a computer under the following environment.

- Operating system: Windows 10
- Location for creating shared folder: Desktop
- Folder path: C:\Users\xxxx\Desktop\scan_folder (create a network folder called "scan_folder" on the desktop)

1. Log in to the computer on which you want to create the network folder with a user account that has administrator authority.

Note:

If you do not know which user account has administrator authority, check with your computer administrator.

2. Make sure that the device name (computer name) does not contain double-byte characters. Click the Windows Start button, and then select  **Settings > System > About**.

Note:

If there are double-byte characters in the device name, file saving may fail.

3. Check that the string displayed in **Device Specifications > Device Name** does not contain any double-byte characters.

There should be no issues if the device name contains only single-byte characters. Close the screen.

Example: EPSPUB313

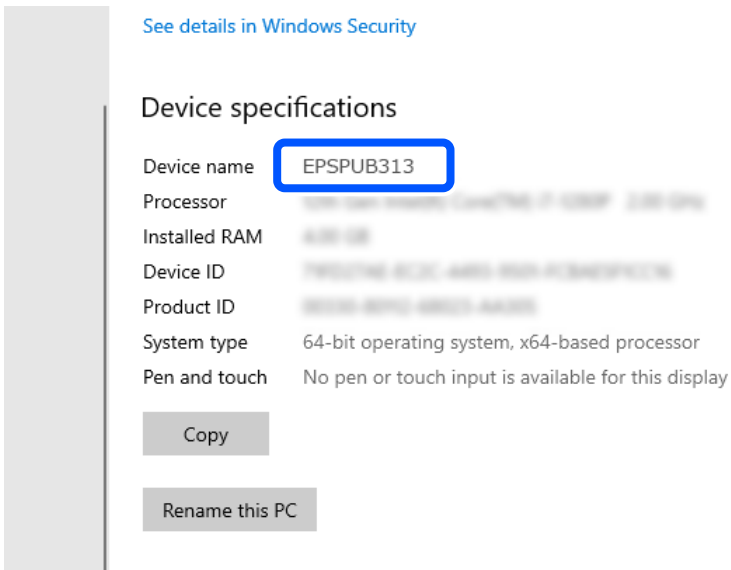

Important:

If the device name contains double-byte characters, use a computer that does not use double-byte characters or rename the device.

If you need to change the device name, make sure you check with your computer administrator in advance as it may affect computer management and access to resources.

Next, check your computer settings.

4. Click the Windows start button, and then select **Windows System > Control Panel**.

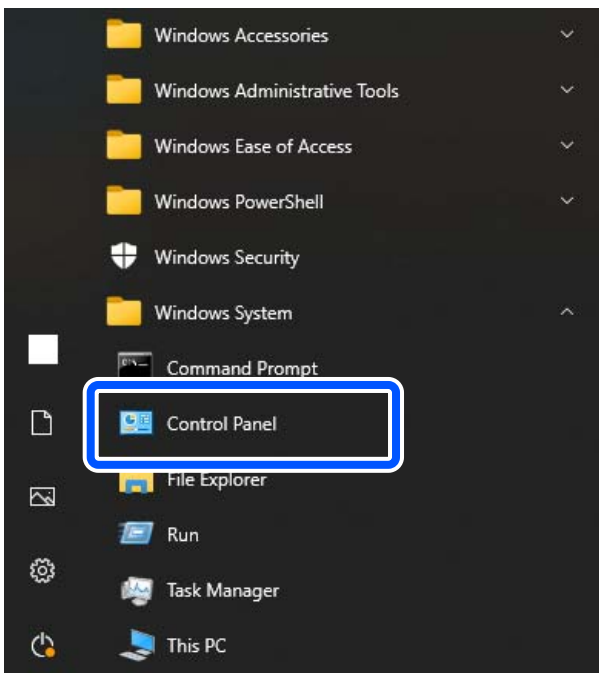

5. On the Control Panel, click **Network and Internet > Network and Sharing Center > Change advanced sharing settings**.

The network profile is displayed.

6. Make sure that **Turn on file and printer sharing** is selected under **File and Printer Sharing** for the network profile (current profile).

If already selected, click **Cancel** and close the window.

When you change the settings, click **Save Changes** and close the window.

Next, create a network folder.

7. Create and name a folder on your desktop.

For the folder name, enter within 1 to 12 alphanumeric characters. If the name exceeds 12 characters, you may not be able to access the folder depending on your environment.

Example: scan_folder

8. Right click the folder, and then select **Properties**.

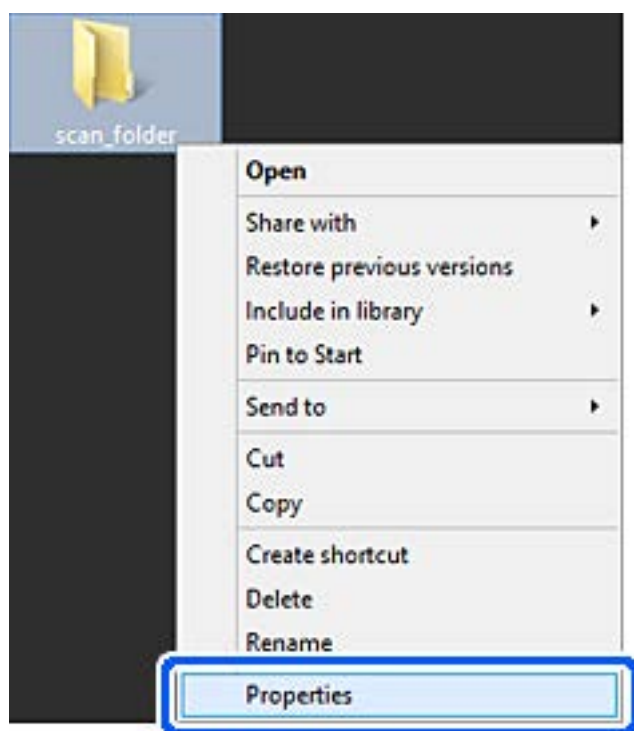

9. Click **Advanced Sharing** on the **Sharing** tab.

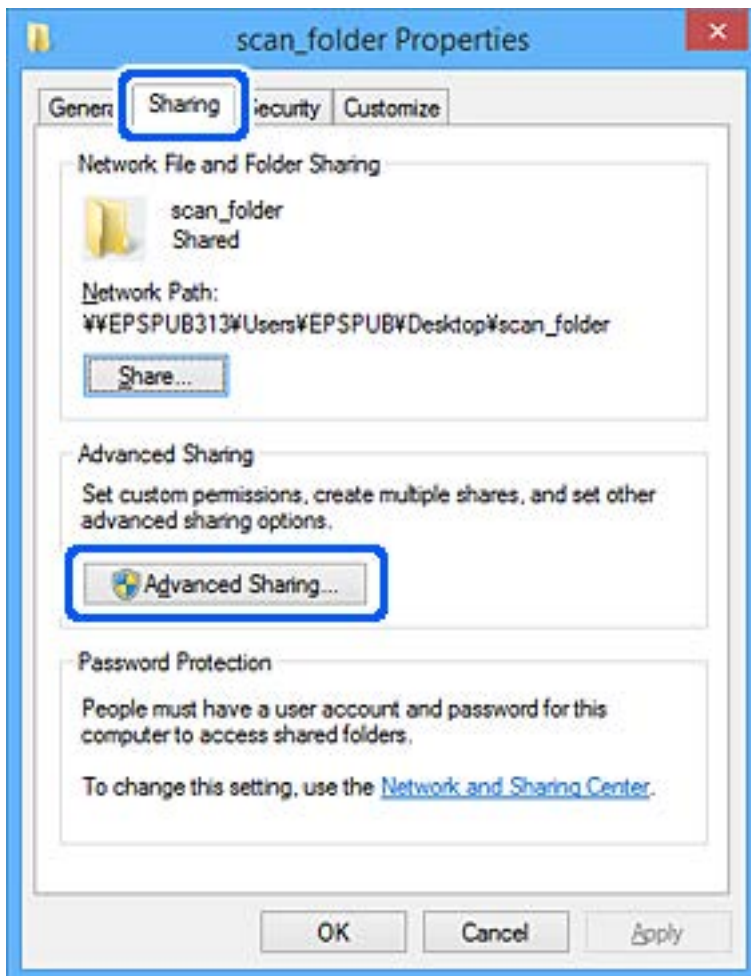

10. Select **Share this folder**, and then click **Permissions**.

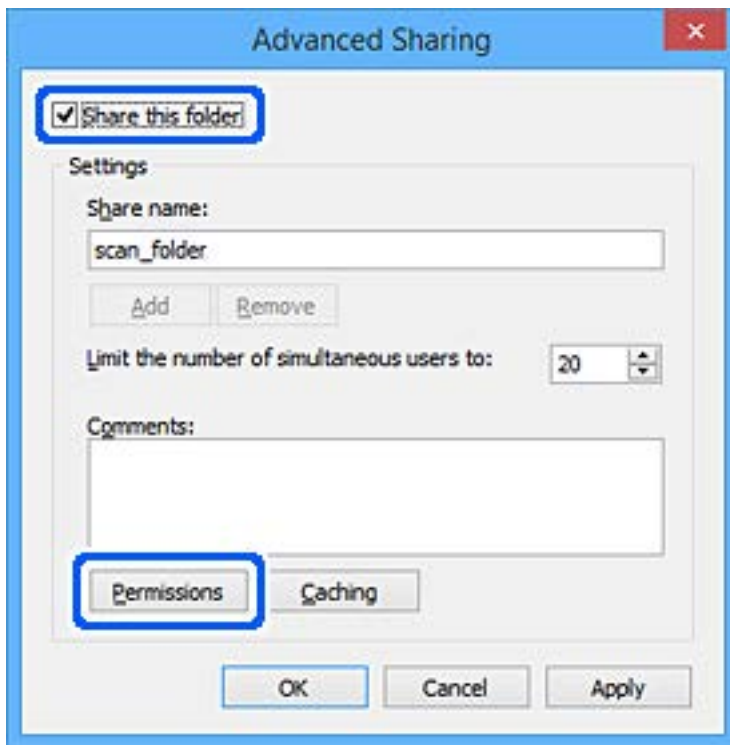

11. Select **Everyone** in **Group or user names**, select **Allow** from **Change**, and then click **OK**.

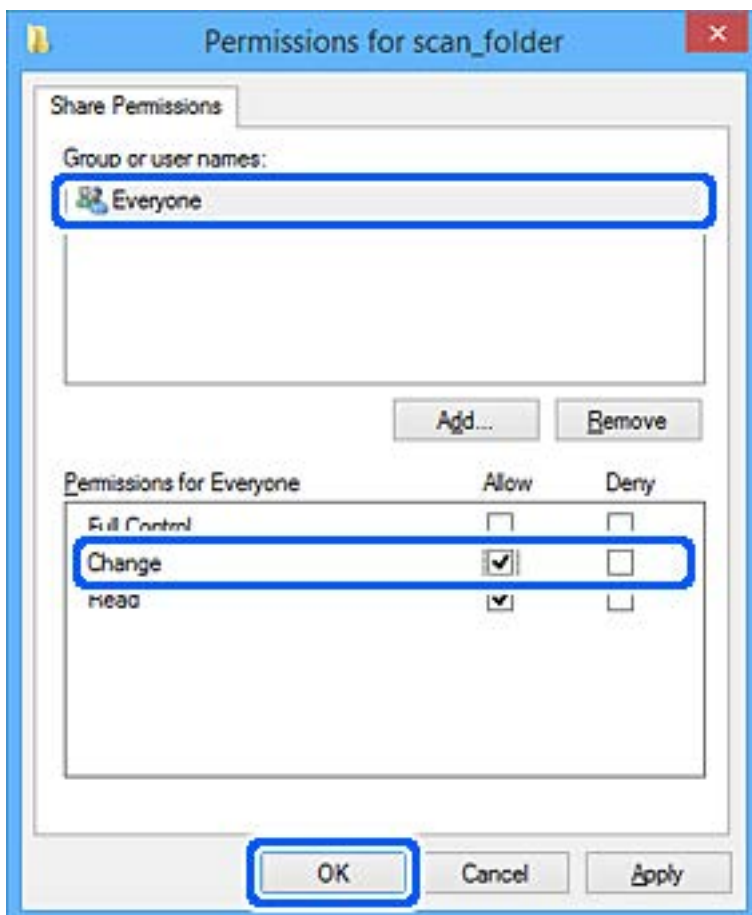

12. Click **OK** to close the screen and return to the Properties window.

Note:

You can check which groups or users have access to the network folder on the **Security** tab > **Group or user names**.

Example: When the user logged on to the computer as well as Administrators can access the network folder

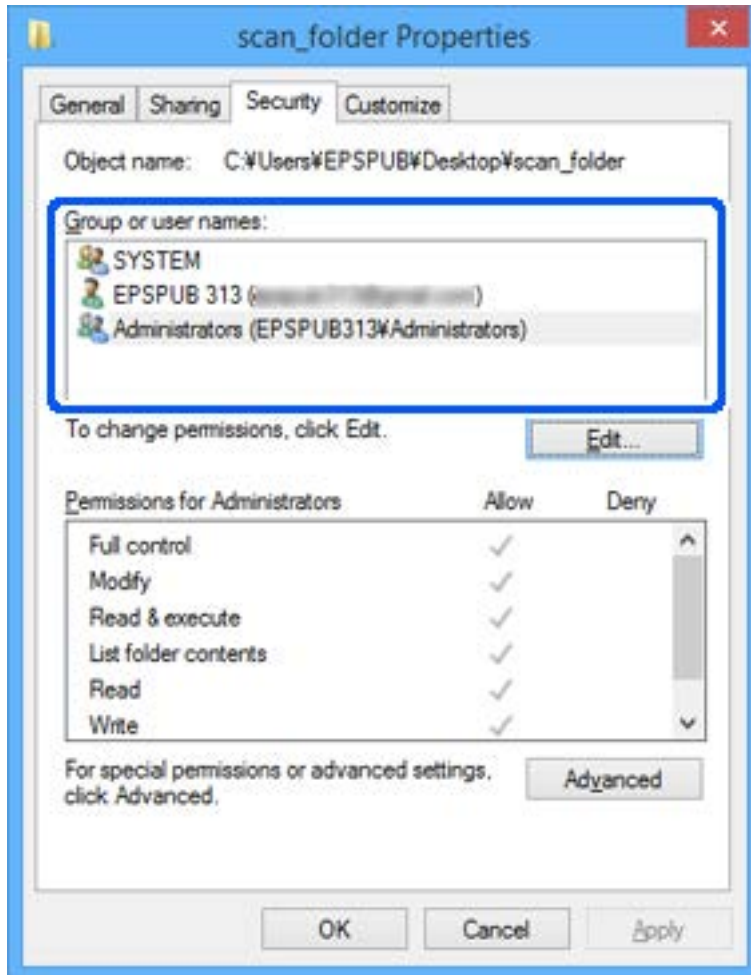

13. Select the **Sharing** tab.

The network path for the network folder is displayed. This is used when registering to your contacts for the scanner. Please write it down.

Example: \\EPSPUB313\scan_folder

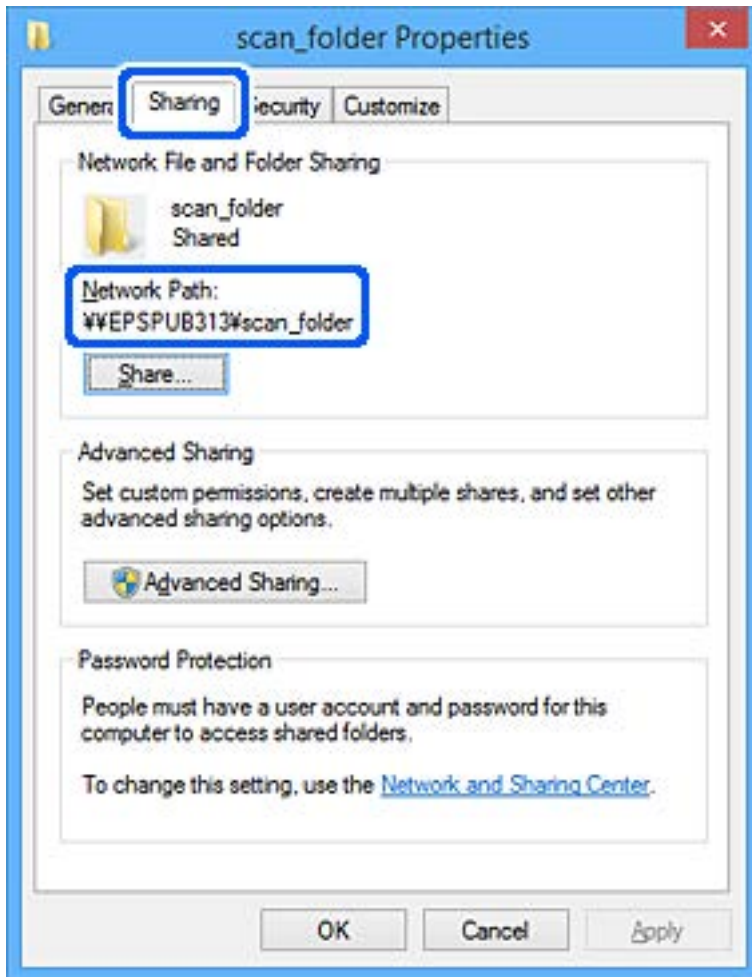

14. Click **Close** or **OK** to close the window.

This completes creating a network folder.

Making Contacts Available

Registering destinations in the scanner's contacts list allows you to easily enter the destination when scanning. You can register the following types of destinations in the contacts list. You can register up to 300 entries in total.

Note:

You can also use the LDAP server (LDAP search) to enter the destination.

Email	Destination for email. You need to configure the email server settings beforehand.
Network Folder	Destination for scan data. You need to prepare the network folder beforehand.

Related Information

➔ [“Cooperation between the LDAP Server and Users” on page 138](#)

Contacts Configuration Comparison

There are three tools for configuring the scanner's contacts: Web Config, Epson Device Admin, and the scanner's control panel. The differences between three tools are listed in the table below.

Features	Web Config*	Epson Device Admin	Scanner's control panel
Registering a destination	✓	✓	✓
Editing a destination	✓	✓	✓
Adding a group	✓	✓	✓
Editing a group	✓	✓	✓
Deleting a destination or groups	✓	✓	✓
Deleting all destinations	✓	✓	–
Importing a file	✓	✓	–
Exporting to a file	✓	✓	–

* Log on as an administrator to make settings.

Registering a Destination to Contacts using Web Config

Note:

You can also register the contacts on the scanner's control panel.

1. Access Web Config and select the **Scan** tab > **Contacts**.
2. Select the number that you want to register, and then click **Edit**.
3. Enter **Name** and **Index Word**.
4. Select the destination type as the **Type** option.

Note:

You cannot change the **Type** option after registration is complete. If you want to change the type, delete the destination and then register again.

5. Enter a value for each item, and then click **Apply**.

Related Information

➔ [“How to Run Web Config in a Web Browser” on page 34](#)

Destination Setting Items

Items	Settings and Explanation
Common Settings	
Name	Enter a name displayed in the contacts in 30 characters or less in Unicode (UTF-16). If you do not specify this, leave it blank.
Index Word	Enter a name using 30 characters or less in Unicode (UTF-16) to search the contacts on the scanner's control panel. If you do not specify this, leave it blank.
Type	Select the type of the address that you want to register.
Assign to Frequent Use	Select to set the registered address as a frequently used address. When setting as a frequently used address, it is displayed on the top screen of scan, and you can specify the destination without displaying the contacts.
Email	
Email Address	Enter between 1 and 255 characters using A-Z a-z 0-9! # \$ % & ' * + - . / = ? ^ _ { } ~ @.
Network Folder (SMB)	
Save to	\\"Folder path" Enter the location where the target folder is located between 1 and 253 characters in Unicode (UTF-16), omitting "\\". Enter the network path displayed on the folder's property screen. See the following for details on setting the network path. "Creating a Network Folder" on page 126
User Name	Enter a user name to access a network folder in 30 characters or less in Unicode (UTF-16). However, avoid using control characters (0x00 to 0x1f, 0x7F).
Password	Enter a password to access a network folder between 0 and 20 characters in Unicode (UTF-16). However, avoid using control characters (0x00 to 0x1f, 0x7F).
FTP	
Secure Connection	Select FTP or FTPS according to the file transfer protocol the FTP server supports. Select FTPS to allow the scanner to communicate with security measures.
Save to	Enter the server name between 1 and 253 characters in Unicode (UTF-16), omitting "ftp://" or "ftps://".
User Name	Enter a user name to access an FTP server in 30 characters or less in Unicode (UTF-16). However, avoid using control characters (0x00 to 0x1f, 0x7F). If the server allows anonymous connections, enter a user name such as Anonymous and FTP. If you do not specify this, leave it blank.
Password	Enter a password to access to an FTP server between 0 and 20 characters in Unicode (UTF-16). However, avoid using control characters (0x00 to 0x1f, 0x7F). If you do not specify this, leave it blank.
Connection Mode	Select the connection mode from the menu. If a firewall is set between the scanner and the FTP server, select Passive Mode .
Port Number	Enter the FTP server port number between 1 and 65535.

Items	Settings and Explanation
Certificate Validation	The FTP server's certificate is validated when this is enabled. This is available when FTPS is selected for Secure Connection . To set up, you need to import the CA Certificate to the scanner.
SharePoint(WebDAV)*	
Secure Connection	Select HTTP or HTTPS according to the file transfer protocol the server supports. Select HTTPS to allow the scanner to communicate with security measures.
Save to	Enter the server name between 1 and 253 characters in Unicode (UTF-16), omitting "http://" or "https://".
User Name	Enter a user name to access a server in 30 characters or less in Unicode (UTF-16). However, avoid using control characters (0x00 to 0x1f, 0x7F). If you do not specify this, leave it blank.
Password	Enter a password to access to a server between 0 and 20 characters in Unicode (UTF-16). However, avoid using control characters (0x00 to 0x1f, 0x7F). If you do not specify this, leave it blank.
Certificate Validation	The server's certificate is validated when this is enabled. This is available when HTTPS is selected for Secure Connection . To set up, you need to import the CA Certificate to the scanner.
Proxy Server	Select whether or not to use a proxy server.

*SharePoint Online is not supported when scanning to network folder from the scanner's control panel.

If you want to save the scanned image to SharePoint Online, use Document Capture Pro after installing the SharePoint Online Connector. See the Document Capture Pro manual for details.

<https://support.epson.net/dcp/>

Registering Destinations as a Group Using Web Config

If the destination type is set to **Email**, you can register the destinations as a group.

1. Access Web Config and select the **Scan** tab > **Contacts**.
2. Select the number that you want to register, and then click **Edit**.
3. Select a group from **Type**.
4. Click **Select for Contact(s) for Group**.
The available destinations are displayed.
5. Select the destination that you want to register to the group, and then click **Select**.
6. Enter a **Name** and **Index Word**.
7. Select whether or not you assign the registered group to the frequently used group.

Note:

Destinations can be registered to multiple groups.

8. Click **Apply**.

Related Information

- ➔ [“How to Run Web Config in a Web Browser” on page 34](#)

Backing Up and Importing Contacts

Using Web Config or other tools, you can back up and import contacts.

For Web Config, you can back up contacts by exporting the scanner settings that include contacts. The exported file cannot be edited because it is exported as a binary file.

When importing the scanner settings to the scanner, contacts are overwritten.

For Epson Device Admin, only contacts can be exported from the device's property screen. Also, if you do not export the security-related items, you can edit the exported contacts and import them because this can be saved as a SYLK file or CSV file.

Importing Contacts Using Web Config

If you have a scanner that allows you to backup contacts and is compatible with this scanner, you can register contacts easily by importing the backup file.

Note:

For instructions on how to back up the scanner contacts, see the manual provided with the scanner.

Follow the steps below to import the contacts to this scanner.

1. Access Web Config, select **Device Management** tab > **Export and Import Setting Value** > **Import**.
2. Select the backup file you created in **File**, enter the password, and then click **Next**.
3. Select the **Contacts** checkbox, and then click **Next**.

Backing up Contacts Using Web Config

Contacts data may be lost due to a scanner malfunction. We recommend that you make a backup of the data whenever you update the data. Epson shall not be responsible for the loss of any data, for backing up or recovering data and/or settings even during a warranty period.

Using Web Config, you can back up the contact data stored in the scanner to the computer.

1. Access Web Config, and then select the **Device Management** tab > **Export and Import Setting Value** > **Export**.
2. Select the **Contacts** checkbox under the **Scan** category.
3. Enter a password to encrypt the exported file.
You need the password to import the file. Leave this blank if you do not want to encrypt the file.
4. Click **Export**.

Export and Bulk Registration of Contacts Using Tool

If you use Epson Device Admin, you can back up just the contacts and edit the exported files, then register them all at once.

It is useful if you want to back up only the contacts or when you replace the scanner and you want to transfer the contacts from the old one to new one.

Exporting Contacts

Save the contacts information to the file.

You can edit files saved in SYLK format or csv format by using a spreadsheet application or text editor. You can register all at once after deleting or adding the information.

Information that includes security items such as password and personal information can be saved in binary format with a password. You cannot edit the file. This can be used as the backup file of the information including the security items.

1. Start Epson Device Admin.
2. Select **Devices** on the side bar task menu.
3. Select the device you want to configure from the device list.
4. Click **Device Configuration** on the **Home** tab on the ribbon menu.
When the administrator password has been set, enter the password and click **OK**.
5. Click **Common > Contacts**.
6. Select the export format from **Export > Export items**.

All Items

Export the encrypted binary file. Select when you want to include the security items such as password and personal information. You cannot edit the file. If you select it, you have to set the password. Click **Configuration** and set a password between 8 and 63 characters long in ASCII. This password is required when importing the binary file.

Items except Security Information

Export the SYLK format or csv format files. Select when you want to edit the information of the exported file.

7. Click **Export**.
8. Specify the place to save the file, select the file type, and then click **Save**.
The completion message is displayed.
9. Click **OK**.
Check that the file is saved to the specified place.

Importing Contacts

Import the contacts information from the file.

You can import the files saved in SYLK format or csv format or the backed-up binary file that includes the security items.

1. Start Epson Device Admin.
2. Select **Devices** on the side bar task menu.
3. Select the device you want to configure from the device list.
4. Click **Device Configuration** on the **Home** tab on the ribbon menu.
When the administrator password has been set, enter the password and click **OK**.
5. Click **Common > Contacts**.
6. Click **Browse** on **Import**.
7. Select the file you want to import and then click **Open**.
When you select the binary file, in **Password** enter the password you set when exporting the file.
8. Click **Import**.
The confirmation screen is displayed.
9. Click **OK**.
The validation result is displayed.
 - Edit the information read
Click when you want to edit the information individually.
 - Read more file
Click when you want to import multiple files.
10. Click **Import**, and then click **OK** on the import completion screen.
Return to the device's property screen.
11. Click **Transmit**.
12. Click **OK** on the confirmation message.
The settings are sent to the scanner.
13. On the sending completion screen, click **OK**.
The scanner's information is updated.
Open the contacts from Web Config or scanner's control panel, and then check that the contact is updated.

Cooperation between the LDAP Server and Users

When cooperating with the LDAP server, you can use the address information registered to the LDAP server as the destination of an email.

Configuring the LDAP Server

To use the LDAP server information, register it on the scanner.

1. Access the Web Config and select the **Network** tab > **LDAP Server** > **Basic**.
2. Enter a value for each item.
3. Select **OK**.

The settings you have selected are displayed.

LDAP Server Setting Items

Items	Settings and Explanation
Use LDAP Server	Select Use or Do Not Use .
LDAP Server Address	Enter the address of the LDAP server. Enter between 1 and 255 characters of either IPv4, IPv6, or FQDN format. For the FQDN format, you can use alphanumeric characters in ASCII (0x20-0x7E) and "-" except for the beginning and end of the address.
LDAP server Port Number	Enter the LDAP server port number between 1 and 65535.
Secure Connection	Specify the authentication method when the scanner accesses the LDAP server.
Certificate Validation	When this is enabled, the certificate of the LDAP sever is validated. We recommend this is set to Enable . To set up, the CA Certificate needs to be imported to the scanner.
Search Timeout (sec)	Set the length of time for searching before timeout occurs between 5 and 300.
Authentication Method	Select one of the methods. If you select Kerberos Authentication , select Kerberos Settings to make settings for Kerberos. To perform Kerberos Authentication, the following environment is required. <ul style="list-style-type: none"> <input type="checkbox"/> The scanner and the DNS server can communicate. <input type="checkbox"/> The time of the scanner, KDC server, and the server that is required for authentication (LDAP server, SMTP server, File server) are synchronized. <input type="checkbox"/> When the service server is assigned as the IP address, the FQDN of the service server is registered on the DNS server reverse lookup zone.
Kerberos Realm to be Used	If you select Kerberos Authentication for Authentication Method , select the Kerberos realm that you want to use.
Administrator DN / User Name	Enter the user name for the LDAP server in 128 characters or less in Unicode (UTF-8). You cannot use control characters, such as 0x00-0x1F and 0X7F. This setting is not used when Anonymous Authentication is selected as the Authentication Method . If you do not specify this, leave it blank.
Password	Enter the password for the LDAP server authentication in 128 characters or less in Unicode (UTF-8). You cannot use control characters, such as 0x00-0x1F and 0X7F. This setting is not used when Anonymous Authentication is selected as the Authentication Method . If you do not specify this, leave it blank.

Kerberos Settings

If you select **Kerberos Authentication** for **Authentication Method** of **LDAP Server** > **Basic**, make the following Kerberos settings from the **Network** tab > **Kerberos Settings**. You can register up to 10 settings for the Kerberos settings.

Items	Settings and Explanation
Realm (Domain)	Enter the realm of the Kerberos authentication in 255 characters or less in ASCII (0x20-0x7E). If you do not register this, leave it blank.
KDC Address	Enter the address of the Kerberos authentication server. Enter 255 characters or less in either IPv4, IPv6 or FQDN format. If you do not register this, leave it blank.
Port Number (Kerberos)	Enter the Kerberos server port number between 1 and 65535.

Configuring the LDAP Server Search Settings

When you set up the search settings, you can use the email address registered to the LDAP server.

1. Access Web Config and select the **Network** tab > **LDAP Server** > **Search Settings**.
2. Enter a value for each item.
3. Click **OK** to display the setting result.

The settings you have selected are displayed.

LDAP Server Search Setting Items

Items	Settings and Explanation
Search Base (Distinguished Name)	If you want to search an arbitrary domain, specify the domain name of the LDAP server. Enter between 0 and 128 characters in Unicode (UTF-8). If you do not search for arbitrary attribute, leave this blank. Example for the local server directory: dc=server,dc=local
Number of search entries	Specify the number of search entries between 5 and 500. The specified number of the search entries is saved and displayed temporarily. Even if the number of the search entries is over the specified number and an error message appears, the search can be completed.
User name Attribute	Specify the attribute name to display when searching for user names. Enter between 1 and 255 characters in Unicode (UTF-8). The first character should be a-z or A-Z. Example: cn, uid
User name Display Attribute	Specify the attribute name to display as the user name. Enter between 0 and 255 characters in Unicode (UTF-8). The first character should be a-z or A-Z. Example: cn, sn
Email Address Attribute	Specify the attribute name to display when searching for email addresses. Enter a combination of between 1 and 255 characters using A-Z, a-z, 0-9, and -. The first character should be a-z or A-Z. Example: mail

Items	Settings and Explanation
Arbitrary Attribute 1 - Arbitrary Attribute 4	You can specify other arbitrary attributes to search for. Enter between 0 and 255 characters in Unicode (UTF-8). The first character should be a-z or A-Z. If you do not want to search for arbitrary attributes, leave this blank. Example: o, ou

Checking the LDAP Server Connection

Performs the connection test to the LDAP server by using the parameter set on **LDAP Server > Search Settings**.

1. Access Web Config and select the **Network** tab > **LDAP Server** > **Connection Test**.
2. Select **Start**.

The connection test is started. After the test, the check report is displayed.

LDAP Server Connection Test References

Messages	Explanation
Connection test was successful.	This message appears when the connection with the server is successful.
Connection test failed. Check the settings.	This message appears for the following reasons: <ul style="list-style-type: none"> <input type="checkbox"/> The LDAP server address or the port number is incorrect. <input type="checkbox"/> A timeout has occurred. <input type="checkbox"/> Do Not Use is selected as the Use LDAP Server. <input type="checkbox"/> If Kerberos Authentication is selected as the Authentication Method, settings such as Realm (Domain), KDC Address and Port Number (Kerberos) are incorrect.
Connection test failed. Check the date and time on your product or server.	This message appears when the connection fails because the time settings for the scanner and the LDAP server are mismatched.
Authentication failed. Check the settings.	This message appears for the following reasons: <ul style="list-style-type: none"> <input type="checkbox"/> User Name and/or Password is incorrect. <input type="checkbox"/> If Kerberos Authentication is selected as the Authentication Method, the time/date may not be configured.
Cannot access the product until processing is complete.	This message appears when the scanner is busy.

Setting Up AirPrint

Access Web Config, select the **Network** tab, then select **AirPrint Setup**.

Items	Explanation
Bonjour Service Name	Enter a Bonjour service name, using ASCII text (0x20-0x7E) and up to 41 characters.
Bonjour Location	Enter a description of the scanner's location, using Unicode (UTF-8) text and up to 127 bytes.
Wide-Area Bonjour	Set whether or not to use Wide-Area Bonjour. If you use it, the scanner must be registered on the DNS server in order to search for the scanner over the segment.
Enable AirPrint	Enables Bonjour and AirPrint (Scan service). This button is available only when AirPrint is disabled. Note: <i>If AirPrint is disabled, Mopria scanning from Chromebooks, Windows, and the Mopria Scan app is also disabled.</i>

Customizing the Control Panel Display

Registering Presets.	144
Editing the Home Screen of the Control Panel.	146

Registering Presets

You can register frequently used scanning setting as **Presets**. You can register up to 48 presets.

Note:

- ❑ You can register the current settings by selecting  on the start scanning screen.
- ❑ You can also register **Presets** in Web Config.
Select the **Scan** tab > **Presets**.
- ❑ If you select **Scan to Computer** when registering, you can register the job created in Document Capture Pro as **Presets**. This is available only for computers connected over a network. Register the job in Document Capture Pro in advance.
- ❑ If **Lock Setting** is enabled on the control panel, only the administrator can register **Presets**.

1. Select **Presets** on the home screen on the scanner's control panel.

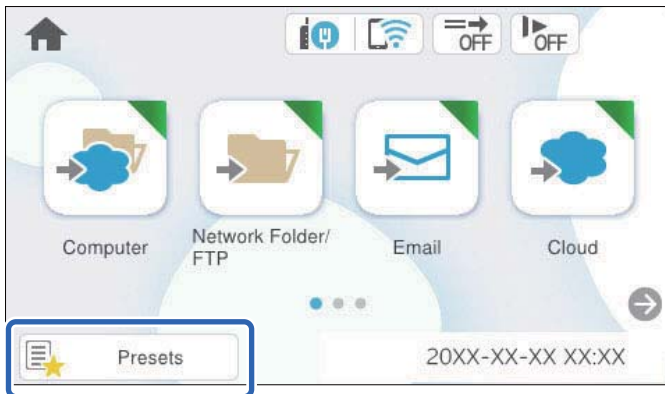

2. Select .

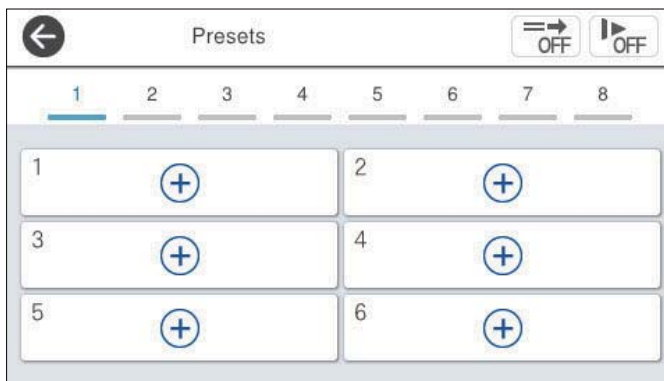

3. Select the menu you want to use to register a preset.



4. Set each item, and then select .

Note:

When you select **Scan to Computer**, select the computer on which Document Capture Pro is installed, and then select a registered job. This is available only for computers connected over a network.

5. Make the preset settings.
 - Name:** Set the name.
 - Set Icon:** Set the image and color of the icon to display.
 - Quick Send Setting:** Immediately starts scanning without confirmation when the preset is selected.
 - Contents:** Check scan settings.

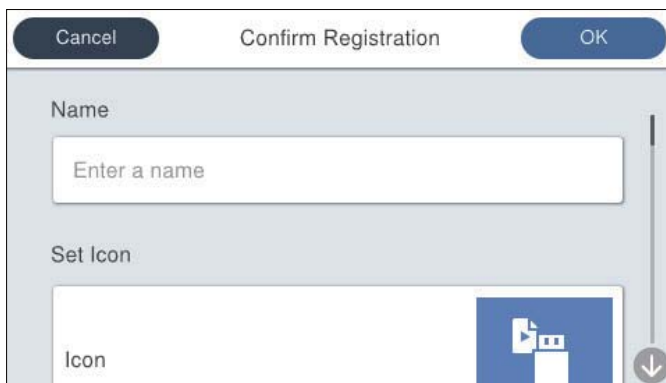

6. Select OK.

Related Information

➔ [“Setting a Job” on page 116](#)

Menu Options of Presets

You can change the settings of a preset by selecting  in each preset.

Change Name:

Changes the preset name.

Change Icon:

Changes the icon image and color of the preset.

Quick Send Setting:

Immediately starts scanning without confirmation when the preset is selected.

Change Position:

Changes the display order of the presets.

Delete:

Deletes the preset.

Add or Remove Icon on Home:

Adds or deletes the preset icon from the home screen.

Confirm Details:

View the settings of a preset. You can load the preset by selecting **Use This Setting**.

Editing the Home Screen of the Control Panel

You can customize the home screen by selecting **Settings** > **Edit Home** on the scanner's control panel.

- Layout** : Changes the display method of the menu icons.
[“Changing the Layout of the Home Screen” on page 146](#)
- Add Icon**: Adds icons to the **Presets** settings you have made, or restores icons that have been removed from the screen.
[“Add Icon” on page 147](#)
- Remove Icon** : Removes icons from the home screen.
[“Remove Icon” on page 148](#)
- Move Icon** : Changes the display order of the icons.
[“Move Icon” on page 149](#)
- Restore Default Icon Display** : Restores the default display settings for the home screen.

Changing the Layout of the Home Screen

1. Select **Settings** > **Edit Home** > **Layout** on the scanner's control panel.

2. Select **Line** or **Matrix**.

Line:



Matrix:



3. Select  to return and check the home screen.

Add Icon

1. Select **Settings** > **Edit Home** > **Add Icon** on the scanner's control panel.
2. Select **Function** or **Presets**.
 - Function:** Displays the default functions shown on the home screen.
 - Presets:** Displays registered presets.

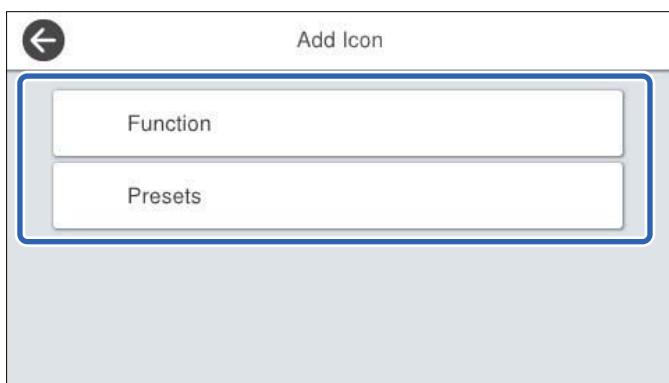

3. Select the item you want to add to the home screen.

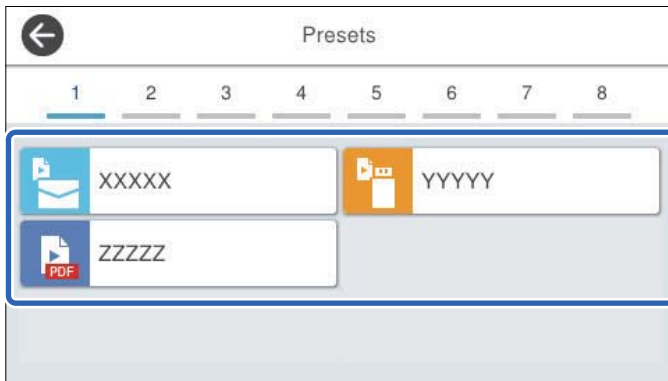

4. Select the blank space where you want to add the item.
If you want to add multiple icons, repeat steps 3 to 4.

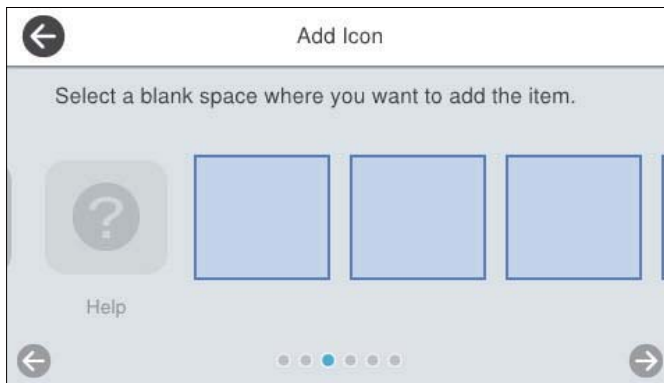

5. Select  to return and check the home screen.

Remove Icon

1. Select **Settings** > **Edit Home** > **Remove Icon** on the scanner's control panel.
2. Select the icon you want to remove.

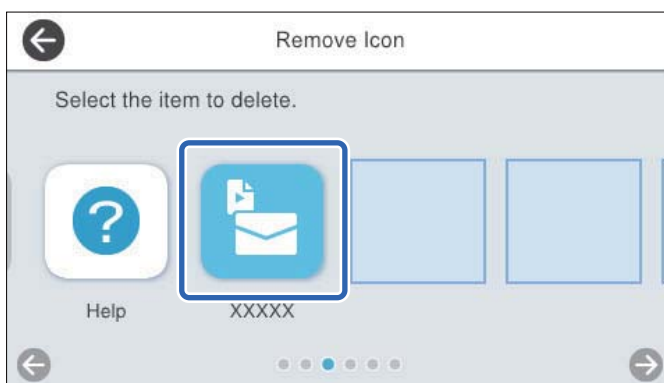

3. Select **Yes** to finish.

If you want to remove multiple icons, repeat procedure 2 to 3.

4. Select  to return and check the home screen.

Move Icon

1. Select **Settings** > **Edit Home** > **Move Icon** on the scanner's control panel.
2. Select the icon you want to move.

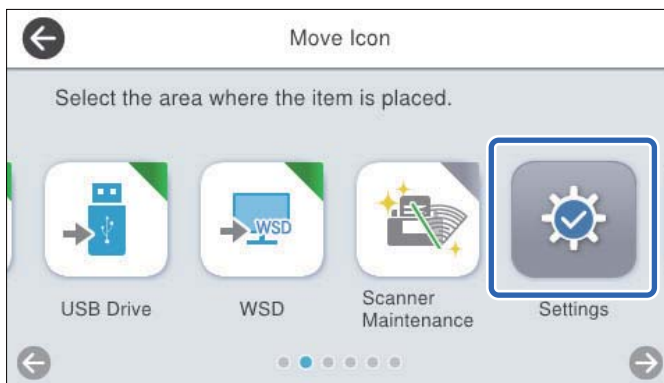

3. Select the destination frame.

If another icon is already set in the destination frame, the icons are replaced.

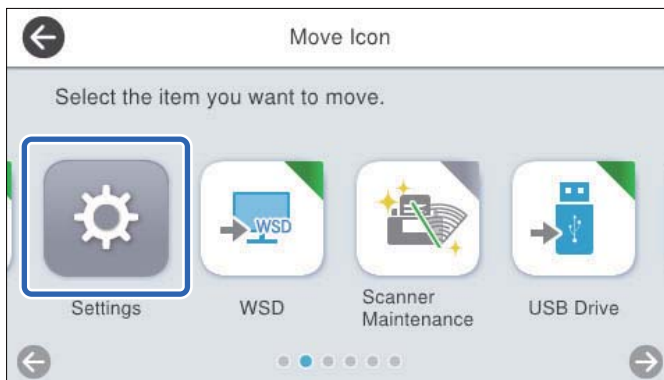

4. Select  to return and check the home screen.

Menu Options for Settings

Basic Settings.	151
Scanner Settings.	152
Edit Home.	153
User Settings.	154
Network Settings.	154
Web Service Settings.	155
Document Capture Pro.	156
Contacts Manager.	156
System Administration.	156
Device Information.	158
Scanner Maintenance.	159
Roller Replacement Alert Setting.	159
Regular Cleaning Alert Settings.	159

Basic Settings

LCD Brightness

Adjust the brightness of the LCD screen.

Sounds

- Button Press: Set the volume for tapping sounds on the control panel, or when authentication is successful on the login screen.
- Error Tone: Set the volume for when an error occurs, or an authentication fails on the login screen.

Sleep Timer

Adjust the time period for entering sleep mode (energy saving mode) when the scanner has not performed any operations. The LCD screen turns black when the set time has passed.

When you are logged in to the control panel as an administrator, you are logged out when the scanner enters sleep mode.

Note:

You can also set from Web Config. Select **Device Management > Power Saving > Sleep Timer**.

Power Off Settings

Your product may have this feature or the **Power Off Timer** feature depending on the location of purchase.

Turn off the scanner automatically.

Power Off If Inactive

Select this setting to turn the scanner off automatically if it is not used for a specified period of time. Any increase will affect the product's energy efficiency. Please consider the environment before making any change.

Power Off If Disconnected

Select this setting to turn the scanner off after a specified period of time when all ports including the USB port are disconnected. This feature may not be available depending on your region.

See the following website for the specified period of time.

<https://www.epson.eu/energy-consumption>

Direct power on

Turn on the scanner directly when it is connected to the power source without pressing the power button.

Date/Time Settings

- Date/Time: Enter the current date and time.
- Daylight Saving Time: Select the summer time setting that applies to your area.
- Time Difference: Enter the time difference between your local time and UTC (Coordinated Universal Time).

Language

Select the country or region in which you are using your scanner.

Keyboard

Change the layout of the keyboard on the LCD screen.

Operation Time Out

When set Operation Time Out to **On**, you are returned to the Home screen when no operations have been performed for the specified time. This setting is applied when any screen other than the Home screen is displayed.

When you are logged in to the control panel as an administrator, you are logged out when you are returned to the home screen when the non-operation timer is set.

PC Connection via USB

You can restrict the usage of the USB connection from the computer. If you want to restrict it, select **Disable**.

Scanner Settings

Slow

Slows down the feeding speed whenever scanning. When set to **On**, the icon changes to .

Enable this in the following situations:

- When originals jam frequently
- When loading thin originals
- When scanning different types or sizes of originals at once
- If you feel that the scanner is noisy

Double Feed Stop Timing

Set the operation when any double feed is detect.

- Immediate: Stops feeding immediately after any double feed is detected.
- After Eject: Originals detected as double feed are scanned as is, and the subsequent feed of originals is temporarily stopped.

If the scanned image has no problem, you can resume scanning as is.

DFDS Function

Skips double feed detection once and continues scanning. When set to **On**, the icon changes to .

Enable this to scan originals that are detected as double feeds, for example plastic cards or envelopes.

Paper Protection

Reduces damage to the originals by stopping scanning immediately when the following status is detected.

- A feeding error for the originals occurs
- Originals are fed askew

Select the detection level to enable this feature. See the table below for details on each level.

Level	Description
On-Low	Lower the sensitivity to detect the skew of the originals.
On-Medium	Detect the skew of the stapled originals and the skew that On-Low could not detect.
On-High	Increase the sensitivity to detect the skew of the originals.



Important:

- This function does not always prevent damage of originals.
- Depending on the condition of the originals being fed, feeding errors cannot be detected.

Note:

Depending on the original, the condition of feeding, or the level you set, this feature may not work correctly.

- Select **Off** to disable the feature when scanning plastic cards or thick paper.
- When misdetection occurs frequently, lower the level of this feature.
- Some originals may be misdetected as feeding errors, such as irregular shaped originals or originals scanned askew.
- When loading multiple originals, make sure to align the leading edge of the originals. Originals may be misdetected as feeding errors if the edges of the originals are not aligned, even if they are scanned correctly.
- To scan the originals without skewing, adjust the edge guides to fit the originals before scanning.

Glass Dirt Detection

Detects dirt on the glass surface inside the scanner. You can select the level of the detection.
Depending on the dirt, this feature may not work correctly.

Ultrasonic Double Feed Detection

Detects a double feed error when multiple originals are fed and stops scanning.
Use this when you cannot set double feed detection from the external software.
Depending on the original, such as envelopes, plastic cards, originals with labels or stickers, and so on, this feature may not work correctly.

Automatic Feeding Mode Timeout

Set the timeout when using Automatic Feeding Mode.
This setting is only available when scanning from "Network Folder/FTP", "Email", "Cloud", or "USB Drive". You can set the time to finish scanning automatically when "Automatic Feeding Mode" is set to "On".

Confirm Recipient

Check destination before scanning.

Edit Home

You can edit the display settings for the home screen.

- Layout
Changes the display method for the menu icons.
- Add Icon
Adds icons to the **Presets** you have set, or returns icons you have previously removed from the screen.
- Remove Icon
Removes the icons from the home screen. If you want to re-display removed icons, select **Add Icon** or **Restore Default Icon Display**.
- Move Icon
Changes the display order of the icons.
- Restore Default Icon Display
Restores the default display settings for the home screen.

User Settings

You can change the initial scanning settings for the following.

- Scan to Network Folder/FTP
- Scan to Email
- Scan to USB Drive
- Scan to Cloud



Network Settings

Wi-Fi Setup:

Set up or change wireless network settings. Choose the connection method from following and then follow the instructions on the control panel.

Router:

- Wi-Fi Setup Wizard
- Push Button Setup(WPS)
- Others
 - PIN Code Setup(WPS)
 - Wi-Fi Auto Connect
 - Disable Wi-Fi

You may be able to resolve network problems by disabling the Wi-Fi settings or making the Wi-Fi settings again. Tap   > **Router** > **Change Settings** > **Others** > **Disable Wi-Fi** > **Start Setup**.

Wi-Fi Direct:

Displays the information to connect to the smartphone.

Tap **Change** to change the settings.

- Change Network Name
- Change Password
- Change Frequency Range
 - This setting may not be displayed depending on the region.
- Disable Wi-Fi Direct
- Restore Default Settings

Wired LAN Setup:

Set up or change a network connection that uses a LAN cable and router. When this is being used, Wi-Fi connections are disabled.

Network Status

Displays the current network settings for the following items.

- Wired LAN/Wi-Fi Status
- Wi-Fi Direct Status
- Email Server Status

Advanced

Make the following detailed settings.

- Device Name
- TCP/IP
- Proxy Server
- Email Server
 - Server Settings
 - Connection Check
- IPv6 Address
- Link Speed & Duplex
- Redirect HTTP to HTTPS
- Disable IPsec/IP Filtering
- Disable IEEE802.1X

Web Service Settings

Epson Connect Services:

Displays whether the scanner is registered and connected to Epson Connect.

You can register to the service by selecting **Register** and follow the instructions.

When you have registered, you can change the following settings.

- Suspend/Resume
- Unregister

For details, see the following web site.

<https://www.epsonconnect.com/>

<http://www.epsonconnect.eu> (Europe only)

Document Capture Pro

Group Settings

Enable group settings on the scanner. Use this item when you have enabled group settings on Document Capture Pro.

Group

Enter the group number when **Group Settings** is enabled.

Contacts Manager

Register/Delete:

Register and/or delete contacts for the Scan to Email, and Scan to Network Folder/FTP menus.

Frequent:

Register frequently used contacts to access them quickly. You can also change the order of the list.

View Options:

Change the way the contact list is displayed.

Search Options:

Change the method for searching contacts.

System Administration

Contacts Manager

Register/Delete:

Register and/or delete contacts for the Scan to Email, and Scan to Network Folder/FTP menus.

Frequent:

Register frequently used contacts to access them quickly. You can also change the order of the list.

View Options:

Change the way the contact list is displayed.

Search Options:

Change the method for searching contacts.

Admin Settings

- Admin Password:** Register an administrator password that allows only an administrator to change the settings. Your password must be 8 to 20 characters long.
- Lock Setting:** Lock the scanner settings to protect them from being changed by other users.

Restrictions

Permit to change the settings of the following items when panel lock is enabled.

- Access to Register/Delete Contacts
- Access to Recent of Scan to Email
- Access to Language
- Protection of Personal Data

Access Control:

Access Control:

Select **On** to restrict product features. This requires users to log into the product control panel with their user name and password before they can use control panel features.

Accept Unknown User Jobs:

You can select whether or not to allow jobs that do not have the necessary authentication information.

Password Encryption

Encrypt your password.

If you turn the power off while restart is in progress, data may be damaged and the scanner settings are restored to defaults. In that case, set password information again.

Program Verification on Start Up

At start up, the scanner checks if unauthorized third parties have tampered with the program. If any issues are detected, the scanner does not start.

Customer Research

Select **Approve** to provide product usage information such as the number of scans to Seiko Epson Corporation.

WSD Settings

Enable or disable the WSD (Web Service for Devices) feature.

Restore Default Settings

- Network Settings:** Restore network related settings to their initial status.
- All Except Network Settings:** Restore other settings to their initial status except for network related settings.
- All Settings:** Restore all settings to their initial status when purchased.



Important:

*If you select **All Settings**, all setting data registered to the scanner including the contacts will be deleted. You cannot restore deleted settings.*

Firmware Update:

You can acquire scanner firmware information such as your current version and information on available updates.

Update:

Check if the latest version of the firmware has been uploaded to the network server. If an update is available, you can select whether or not to start updating.

Notification:

Select **On** to receive a notification if a firmware update is available.

Device Information

Serial Number

Displays the serial number of the scanner.

Current Version

Displays the current firmware version.

Total Number of Scans

Displays the total number of scans.

Number of 1-Sided Scans

Displays the number of single-sided scans.

Number of 2-Sided Scans

Displays the number of double-sided scans.

Number of Scans of Carrier Sheet

Displays the number of scans using a Carrier Sheet.

Number of Scans After Replacing Roller

Displays the number of scans after replacing the roller assembly kit.

To reset, select  from **Device Information**, select **Number of Scans After Replacing Roller**, and then select **Yes**.

Number of Scans After Regular Cleaning

Displays the number of scans after performing regular cleaning.

To reset, select  from **Device Information**, select **Number of Scans After Regular Cleaning**, and then select **Yes**.

Authentication Device Status

Displays the status of the authentication device.

Epson Open Platform Information

Displays the status of the Epson Open Platform.

Scanner Maintenance

Roller Cleaning

Displays how to clean the roller inside the scanner.

Roller Replacement

Displays how to replace the roller assembly kit. You can also reset the number after replacing the roller assembly kit.

Regular Cleaning

Displays how to perform regular cleaning of the inside of the scanner. You can also reset the number after performing regular cleaning.

Glass Cleaning

Displays how to perform cleaning for the scanner glass inside the scanner.

Roller Replacement Alert Setting

Count Alert Setting

Changes the scanning number when the roller replacement notification will be displayed.

Regular Cleaning Alert Settings

Warning Alert Setting

Notifies you when to clean inside of the scanner.

Count Alert Setting

Changes the scanning number when the cleaning notification will be displayed.

Maintenance

Cleaning Outside the Scanner.	161
Cleaning Inside the Scanner.	161
Replacing the Roller Assembly Kit.	166
Resetting the Number of Scans After Replacing the Rollers.	171
Energy Saving.	171
Transporting the Scanner.	171
Updating Applications and Firmware.	172

Cleaning Outside the Scanner

Wipe off any stains on the outer case with a dry cloth or a cloth dampened with mild detergent and water.

 **Important:**

- Never use alcohol, thinner, or any corrosive solvent to clean the scanner. Deformation or discoloration may occur.
- Do not let water get inside the product. This could cause a malfunction to occur.
- Never open the scanner case.

1. Press the  button to turn off the scanner.
2. Unplug the AC adapter from the scanner.
3. Clean the outer case with a cloth dampened with mild detergent and water.

Note:

Wipe the touchscreen by using a soft, dry cloth.

Cleaning Inside the Scanner

After using the scanner for a while, paper and room dust on the roller or the glass part inside the scanner may cause paper feed or scanned image quality problems. Clean the inside of the scanner every 5,000 scans.

You can check the latest number of scans on the control panel or in the Epson Scan 2 Utility.

If a surface is stained with a hard-to-remove material, use a genuine Epson cleaning kit to remove the stains. Use a small amount of cleaner on the cleaning cloth to remove the stains.

 **Important:**

- Never use alcohol, thinner, or any corrosive solvent to clean the scanner. Deformation or discoloration may occur.
- Never spray any liquid or lubricant on the scanner. Damage to equipment or circuits may cause abnormal operations.
- Never open the scanner case.

1. Press the  button to turn off the scanner.
2. Unplug the AC adapter from the scanner.

3. Pull the lever and open the scanner cover.

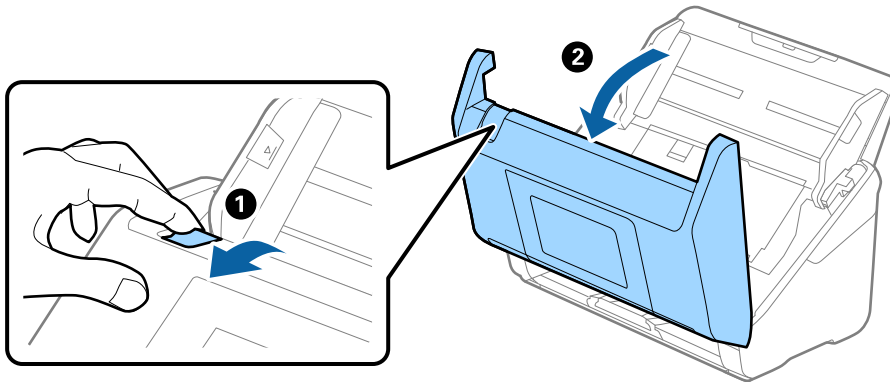

4. Wipe off any stains on the plastic roller (4 locations) and glass surface at the bottom inside of the scanner cover. Wipe with a soft, lint-free cloth dampened with a small amount of dedicated cleaner or water.

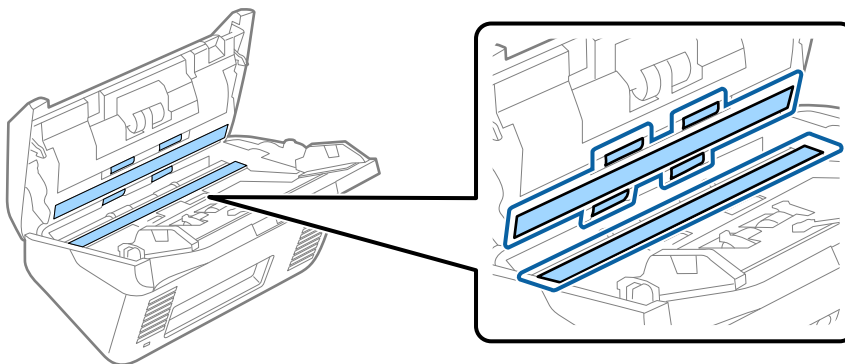

! **Important:**

- Do not place too much force on the glass surface.
- Do not use a brush or a hard tool. Any scratches on the glass may affect the scan quality.
- Do not spray cleaner directly onto the glass surface.

5. Wipe off any stains on the sensors with a cotton swab.

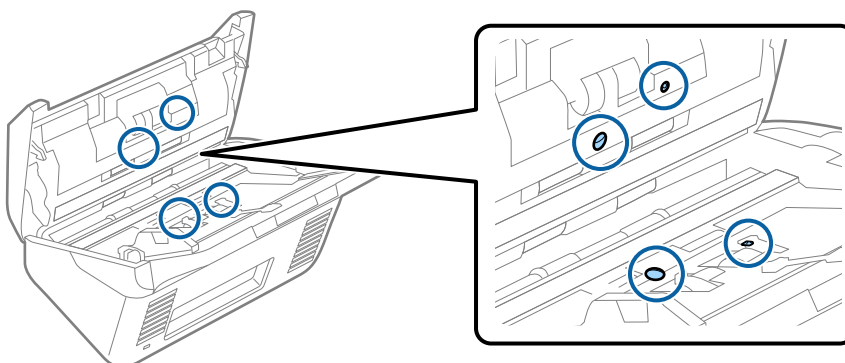

! **Important:**

Do not use liquid such as a cleaner on a cotton swab.

6. Open the cover, and then remove the separation roller.
See “Replacing the Roller Assembly Kit” for more details.

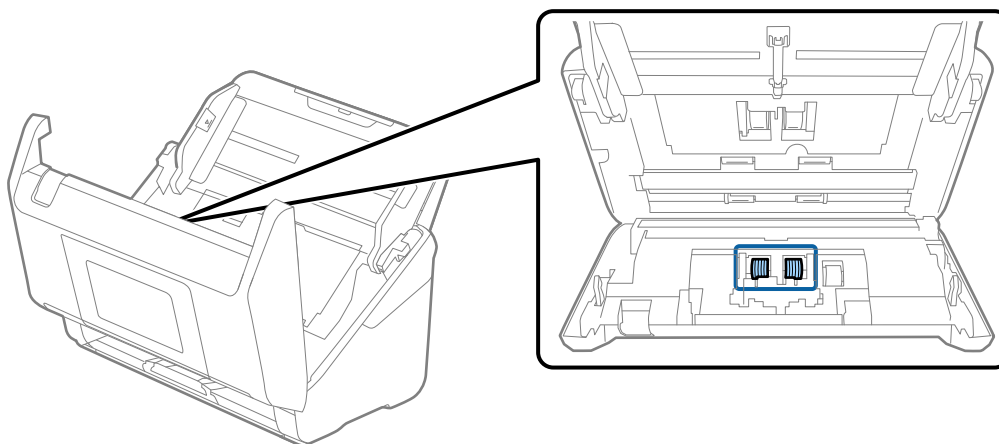

7. Wipe the separation roller. Wipe with a soft, lint-free cloth dampened with a small amount of dedicated cleaner or water.

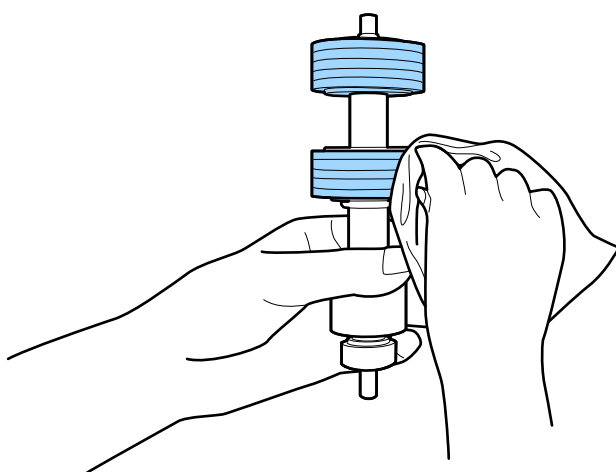

! **Important:**

Use only a genuine Epson cleaning kit or a soft, moist cloth to clean the roller. Using a dry cloth may damage the surface of the roller.

- Open the cover, and then remove the pickup roller.
See “Replacing the Roller Assembly Kit” for more details.

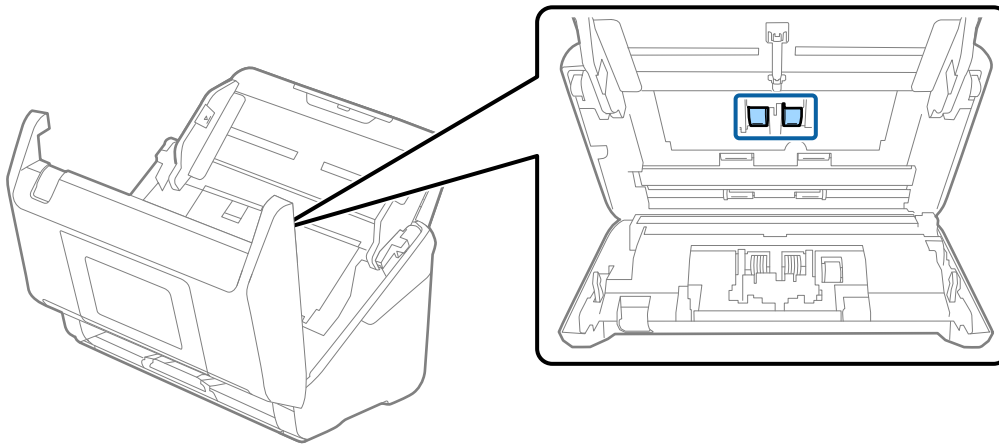

- Wipe the pickup roller. Wipe with a soft, lint-free cloth dampened with a small amount of dedicated cleaner or water.

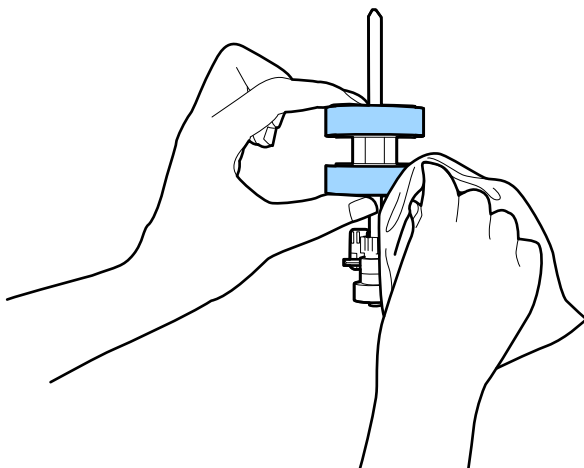

Important:

Use only a genuine Epson cleaning kit or a soft, moist cloth to clean the roller. Using a dry cloth may damage the surface of the roller.

- Close the scanner cover.
- Plug in the AC adapter, and then turn on the scanner.
- Select **Scanner Maintenance** from the home screen.
- On the **Scanner Maintenance** screen, select **Roller Cleaning**.
- Pull the lever to open the scanner cover.
The scanner enters roller cleaning mode.

15. Slowly rotate the rollers at the bottom by tapping anywhere on the LCD. Wipe the surface of the rollers using a genuine Epson cleaning kit or a soft cloth dampened with water. Repeat this until the rollers are clean.

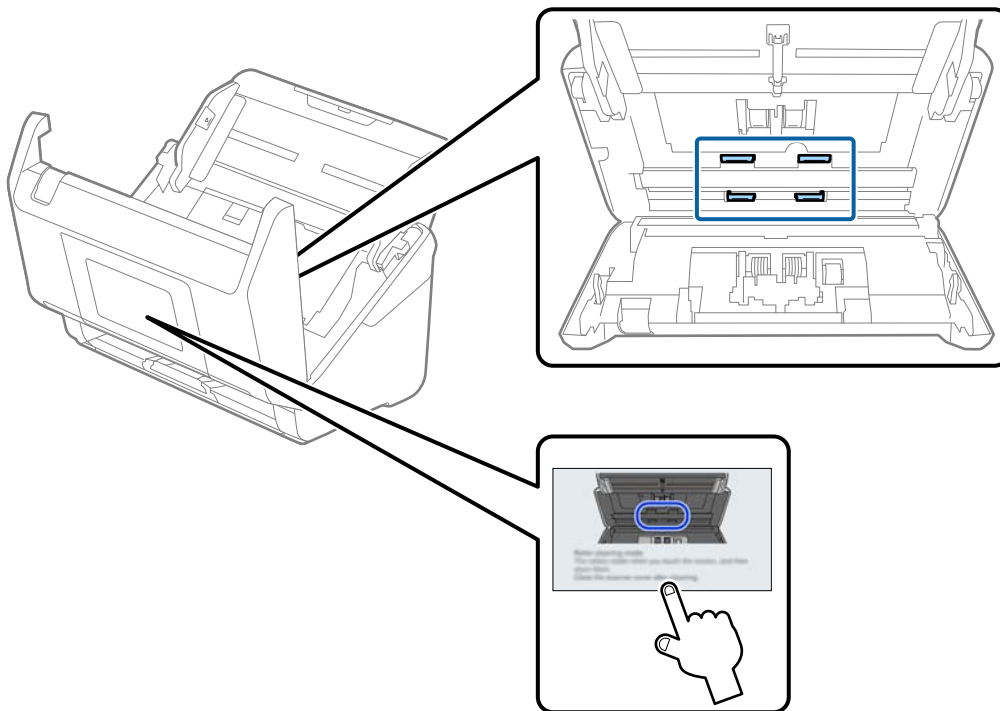

Caution:

Be careful not to get your hands or hair caught in the mechanism when operating the roller. This could cause an injury.

16. Close the scanner cover.
The scanner exits roller cleaning mode.

Related Information

- ➔ [“Cleaning Kit Codes” on page 39](#)
- ➔ [“Replacing the Roller Assembly Kit” on page 166](#)

Replacing the Roller Assembly Kit

The roller assembly kit (the pickup roller and the separation roller) needs to be replaced when the number of scans exceeds the life cycle of the rollers. When a replacement message is displayed on the control panel or your computer screen, follow the steps below to replace it.

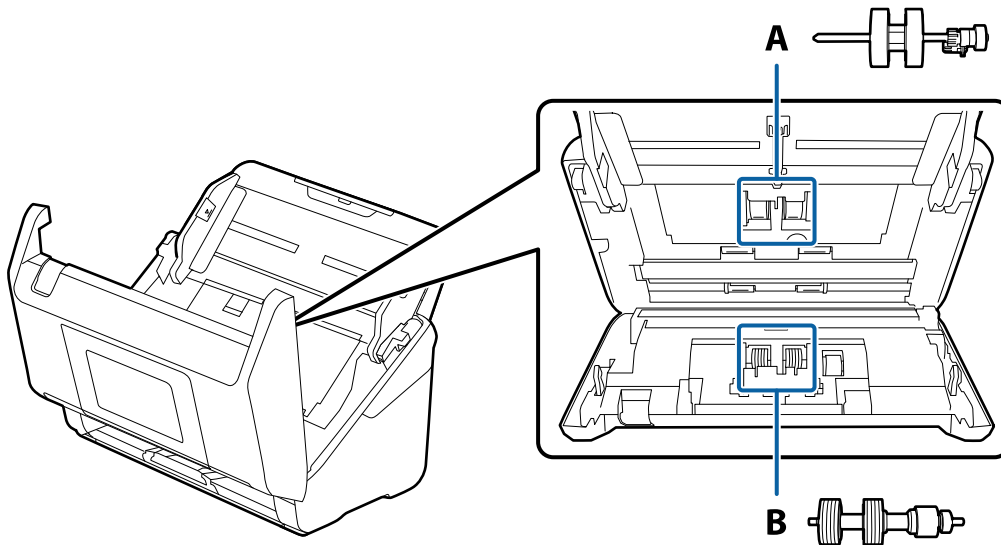

A: pickup roller, B: separation roller

1. Press the  button to turn off the scanner.
2. Unplug the AC adapter from the scanner.
3. Pull the lever and open the scanner cover.

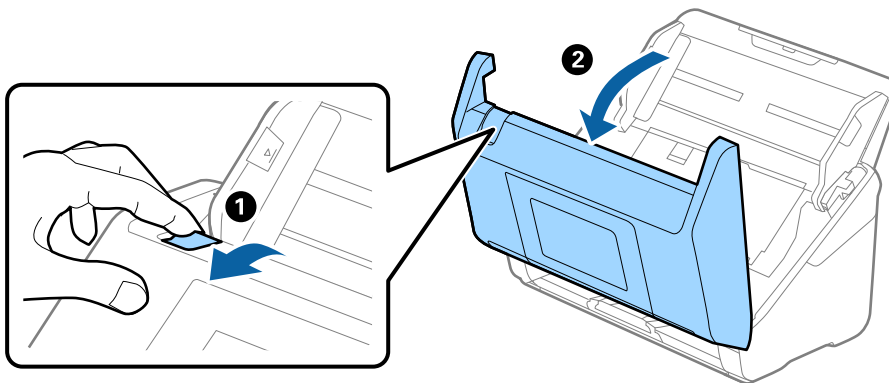

4. Open the cover of the pickup roller, and then slide and remove it.

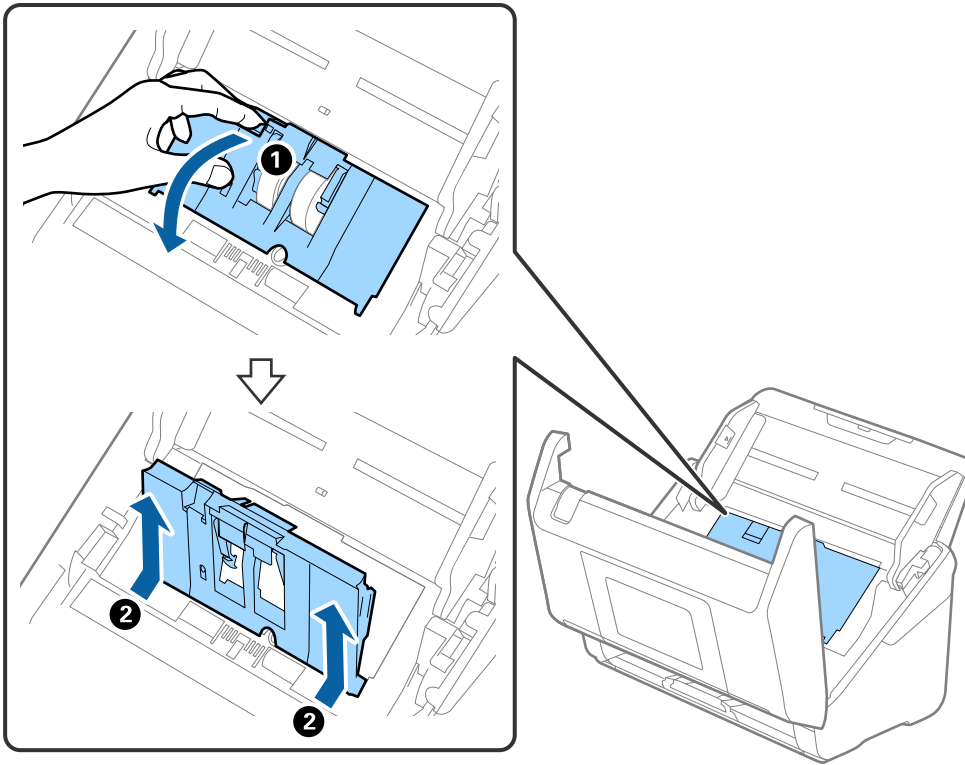

5. Pull down the fixture of the roller axis, and then slide and remove the installed pickup rollers.

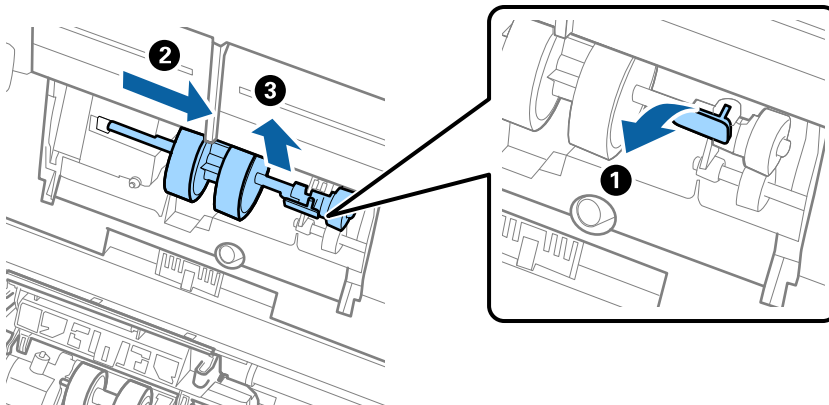

Important:

Do not pull out the pickup roller forcibly. This could damage the inside of the scanner.

6. While holding down the fixture, slide the new pickup roller to the left and insert it into the hole in the scanner. Press the fixture to secure it.

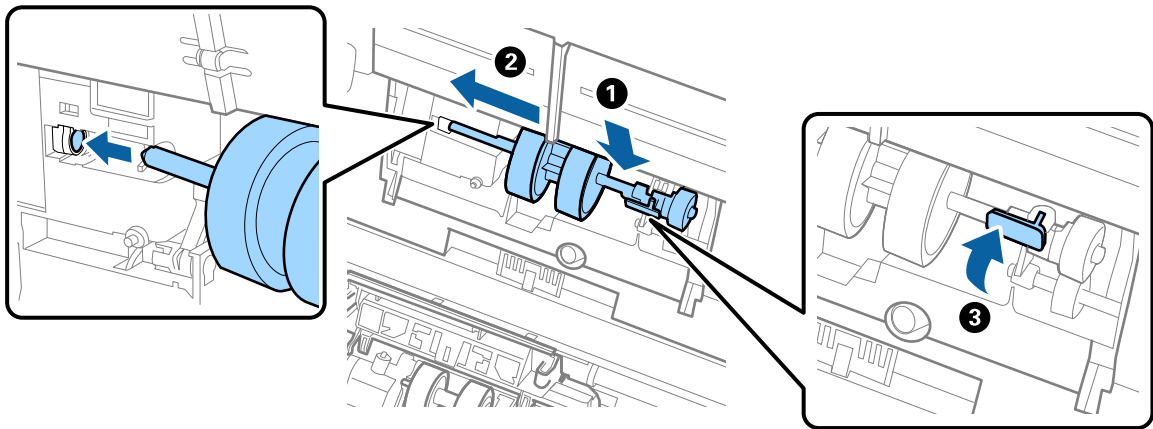

7. Put the edge of the cover of the pickup roller into the groove and slide it. Close the cover firmly.

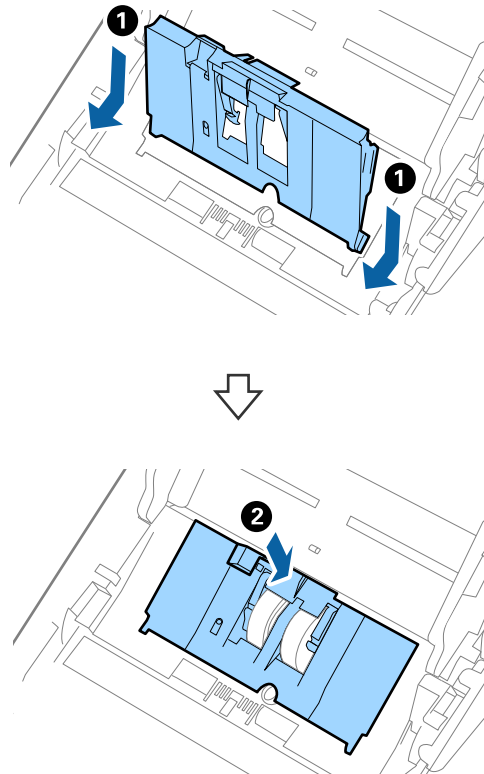

! *Important:*

- Make sure the pick up cover is closed correctly.*
- Make sure the pickup rollers are installed correctly if the cover is hard to close.*
- Do not install the cover while it is raised.*

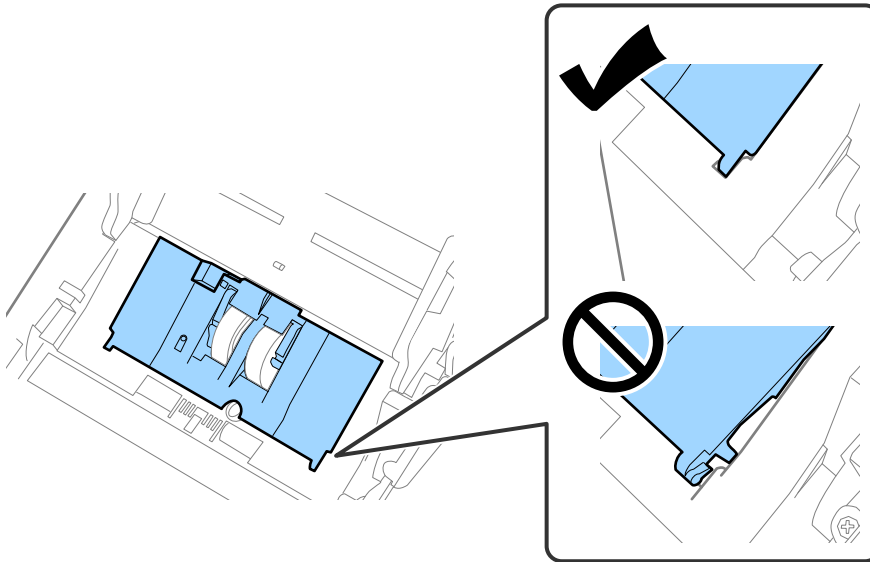

8. Push the hooks on both ends of the separation roller cover to open the cover.

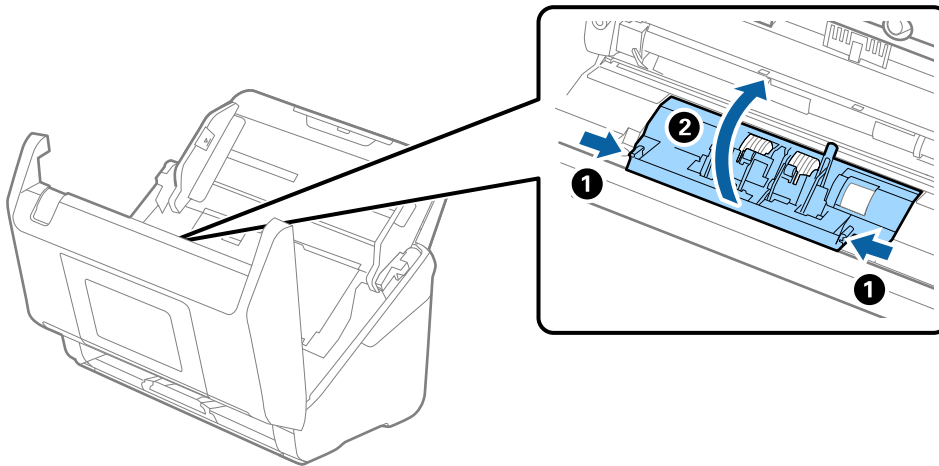

9. Lift the left side of the separation roller, and then slide and remove the installed separation rollers.

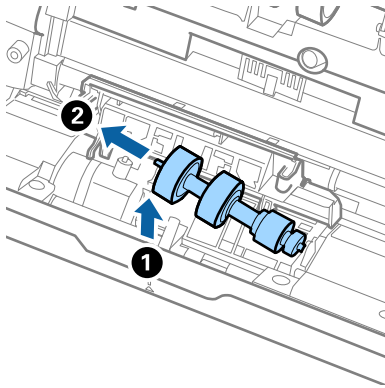

10. Insert the new separation roller axis into the hole on the right side, and then lower the roller.

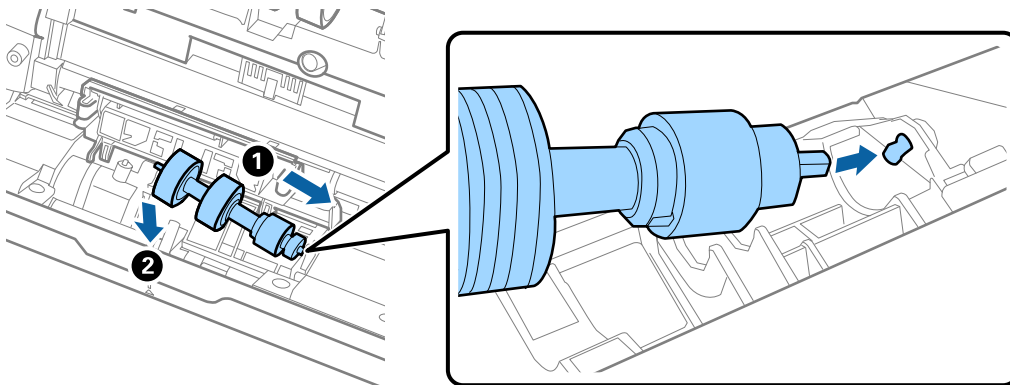

11. Close the separation roller cover.



Important:

If the cover is hard to close, make sure the separation rollers are installed correctly.

12. Close the scanner cover.
13. Plug in the AC adapter, and then turn on the scanner.
14. Reset the scan number on the control panel.

Note:

Dispose of the pickup roller and the separation roller following the rules and regulations of your local authority. Do not disassemble them.

Related Information

➔ [“Roller Assembly Kit Codes” on page 38](#)

Resetting the Number of Scans After Replacing the Rollers

Reset the number of scans using the control panel or Epson Scan 2 Utility after replacing the roller assembly kit.

This section explains how to reset using the control panel.

1. Tap **Scanner Maintenance** on the home screen.
2. Tap **Roller Replacement**.
3. Tap **Reset the Number of Scans**.
4. Select **Number of Scans After Replacing Roller**, and then tap **Yes**.

Note:

To reset from the Epson Scan 2 Utility, start the Epson Scan 2 Utility, click the **Counter** tab, and then click **Reset in Roller Assembly Kit**.

Related Information

➔ [“Replacing the Roller Assembly Kit” on page 166](#)

Energy Saving

You can save energy by using the sleep mode or auto power off mode when no operations are performed by the scanner. You can set the time period before the scanner enters sleep mode and turns off automatically. Any increase will affect the product's energy efficiency. Please consider the environment before making any changes.

1. Select **Settings** on the home screen.
2. Select **Basic Settings**.
3. Select **Sleep Timer** or **Power Off Settings**, and then make settings.

Note:

Available features may vary depending on the location of purchase.

Transporting the Scanner

When you need to transport the scanner to move or for repairs, follow the steps below to pack the scanner.

1. Press the  button to turn off the scanner.
2. Unplug the AC adapter.
3. Remove the cables and the devices.
Remove the optional or supplied Paper Alignment Plate if attached.

4. Close the input tray extension and output tray.

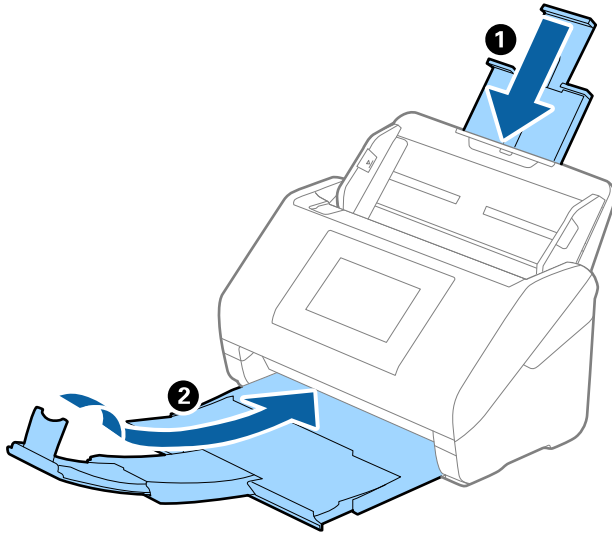

Important:

Make sure you close the output tray securely; otherwise it may be damaged during transport.

5. Remove the input tray.

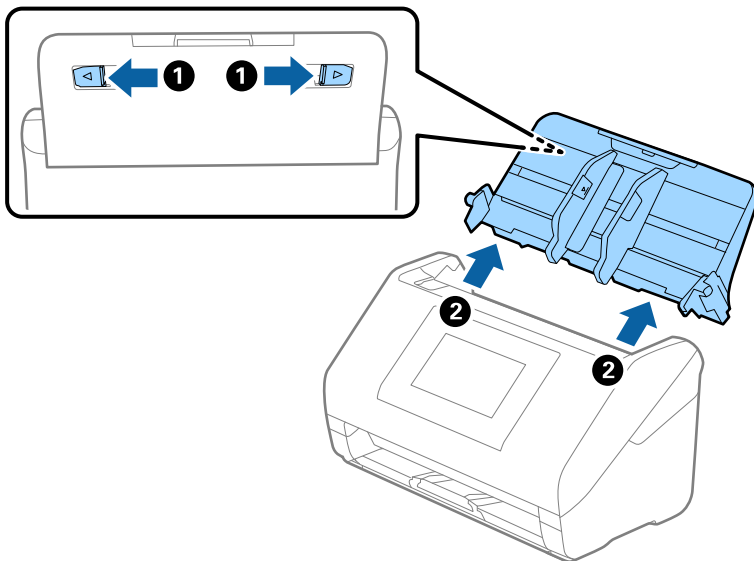

6. Attach the packing materials that came with the scanner, and then repack the scanner in its original box or a sturdy box.

Updating Applications and Firmware

You may be able to clear certain problems and improve or add functions by updating the applications and the firmware. Make sure you use the latest version of the applications and firmware.

 **Important:**

- Do not turn off the computer or the scanner while updating.

Note:

When the scanner can connect to the Internet, you can update the firmware from Web Config. Select the **Device Management** tab > **Firmware Update**, check the displayed message, and then click **Start**.

1. Make sure that the scanner and the computer are connected, and the computer is connected to the internet.
2. Start EPSON Software Updater, and update the applications or the firmware.

Note:

Windows Server operating systems are not supported.

- Windows 11

Click the start button, and then select **All apps > Epson Software > EPSON Software Updater**.

- Windows 10

Click the start button, and then select **Epson Software > EPSON Software Updater**.

- Windows 8.1/Windows 8

Enter the application name in the search charm, and then select the displayed icon.

- Windows 7

Click the start button, and then select **All Programs** or **Programs > Epson Software > EPSON Software Updater**.

- Mac OS

Select **Finder > Go > Applications > Epson Software > EPSON Software Updater**.

Note:

If you cannot find the application you want to update in the list, you cannot update using the EPSON Software Updater. Check for the latest versions of the applications on your local Epson website.

<http://www.epson.com>

Updating the Scanner's Firmware using the Control Panel

If the scanner can be connected to the Internet, you can update the scanner's firmware using the control panel. You can also set the scanner to regularly check for firmware updates and notify you if any are available.

1. Select **Settings** on the home screen.
2. Select **System Administration > Firmware Update > Update**.

Note:

Select **Notification > On** to set the scanner to regularly check for available firmware updates.

3. Check the message displayed on the screen and start searching for available updates.

4. If a message is displayed on the LCD screen informing you that a firmware update is available, follow the on-screen instructions to start the update.



Important:

- Do not turn off or unplug the scanner until the update is complete; otherwise, the scanner may malfunction.
- If the firmware update is not completed or is unsuccessful, the scanner does not start up normally and "Recovery Mode" is displayed on the LCD screen the next time the scanner is turned on. In this situation, you need to update the firmware again using a computer. Connect the scanner to the computer with a USB cable. While "Recovery Mode" is displayed on the scanner, you cannot update the firmware over a network connection. On the computer, access your local Epson website, and then download the latest scanner firmware. See the instructions on the website for the next steps.

Updating Firmware Using Web Config

When the scanner can connect to the Internet, you can update the firmware from Web Config.

1. Access Web Config and select the **Device Management** tab > **Firmware Update**.
2. Click **Start**, and then follow the on-screen instructions.

The firmware confirmation starts, and the firmware information is displayed if the updated firmware exists.

Note:

You can also update the firmware using Epson Device Admin. You can visually confirm the firmware information on the device list. It is useful when you want to update multiple devices' firmware. See the Epson Device Admin guide or help for more details.

Related Information

➔ ["Application for Configuring Scanner Operations \(Web Config\)" on page 34](#)

Updating Firmware without Connecting to the Internet

You can download the device's firmware from Epson website on the computer, and then connect the device and the computer by USB cable to update the firmware. If you cannot update over the network, try this method.

Note:

Before updating, make sure that the scanner driver Epson Scan 2 is installed on your computer. If Epson Scan 2 is not installed, install it again.

1. Check the Epson website for the latest firmware update releases.
<http://www.epson.com>
 - If there is the firmware for your scanner, download it and go to the next step.
 - If there is no firmware information on the website, you are already using the latest firmware.
2. Connect the computer that contains the downloaded firmware to the scanner by USB cable.
3. Double-click the downloaded .exe file.
Epson Firmware Updater starts.
4. Follow the on-screen instructions.

Solving Problems

Problems with the Scanner.	176
Problems when Preparing Network Scanning.	177
Problems Starting Scanning.	179
Paper Feeding Problems.	189
Scanned Image Problems.	194
Document Capture Pro Problems.	199
Uninstalling and Installing Applications.	199

Problems with the Scanner

Checking Error Messages on the Control Panel

If an error message is displayed on the control panel, follow the on-screen instructions or the solutions below to solve the problem.

Note:

See the following if an error message is displayed when scanning to a network folder.

“Messages are Displayed on the Control Panel when Scanning to a Network Folder” on page 187

Error Messages	Solutions
<p>Check the following if a computer is not found. - Connection between the scanner and the computer (USB or network) - Installation of a necessary application - Application version - Power supply to the computer - Firewall and security software settings - Group settings of a scanner and Document Capture Pro - Execution of re-searching For details, see your documentation.</p>	<ul style="list-style-type: none"> <input type="checkbox"/> Make sure the scanner is connected to your computer properly. <input type="checkbox"/> Install Epson Scan 2 and Document Capture Pro/ Document Capture on your computer. <input type="checkbox"/> Install the latest version of the application. <input type="checkbox"/> Make sure the AC adapter is securely connected to the scanner and an electrical outlet. Check that the electrical outlet is working. Plug another device into the electrical outlet and check that you can turn the power on. <input type="checkbox"/> Check the firewall settings for Epson software. <input type="checkbox"/> Set the same group for the scanner and the computer. <input type="checkbox"/> Search for the computer again.
<p>The combination of the IP address and the subnet mask is invalid. See your documentation for more details.</p>	<p>Enter the correct IP address or default gateway. Contact the person who setup the network for assistance.</p>
<p>Recovery Mode</p>	<p>The scanner has started in recovery mode because the firmware update failed. Follow the steps below to try to update the firmware again.</p> <ol style="list-style-type: none"> 1. Connect the computer and the scanner with a USB cable. (During recovery mode, you cannot update the firmware over a network connection.) 2. Visit your local Epson website for further instructions.

Related Information

- ➔ [“Updating Applications and Firmware” on page 172](#)
- ➔ [“Installing Your Applications” on page 200](#)

The Scanner Does Not Turn On

- Make sure the AC adapter is securely connected to the scanner and an electrical outlet.
- Check that the electrical outlet is working. Plug another device into the electrical outlet and check that you can turn the power on.

The Scanner Turns Off Unexpectedly

Check the settings in **Power Off Settings**. If **Power Off Settings** is enabled, the scanner turns off automatically after a set time.

Related Information

➔ [“Energy Saving” on page 171](#)

Forgot Your Administrator's Password

You need help from service personnel. Contact your local dealer.

Note:

The following provides the initial values for the Web Config administrator.

User name: none (blank)

Password: Depends on the label attached to product.

If there is a "PASSWORD" label attached to the back, enter the 8-digit number shown on the label.

If there is no "PASSWORD" label attached, enter the serial number on the label attached to the back of the product for the initial administrator password.

If you restore the administrator password, it is reset to the initial value at the time of purchase.

Problems when Preparing Network Scanning

Hints to Solving Problems

Checking the error message

When trouble has occurred, first check whether there are any messages on the scanner's control panel or driver screen. If you have the notification email set when the events occur, you can promptly learn the status.

Checking the communication status

Check the communication status of server computer or client computer by using the command such as ping and ipconfig.

Connection test

For checking the connection between the scanner to the mail server, perform the connection test from the scanner. Also, check the connection from the client computer to the server to check the communication status.

Initializing the settings

If the settings and communication status show no problem, the problems may be solved by disabling or initializing the network settings of the scanner, and then setting up again.

Related Information

➔ [“Registering an Email Server” on page 123](#)

➔ [“Checking Error Messages on the Control Panel” on page 176](#)

Cannot Access Web Config

■ The IP address is not assigned to the scanner.

Solutions

A valid IP address may not be assigned to the scanner. Configure the IP address using the scanner's control panel. You can confirm the current setting information from the scanner's control panel.

■ Web browser does not support the Encryption Strength for SSL/TLS.

Solutions

SSL/TLS has the Encryption Strength. You can open Web Config by using a web browser that supports bulk encryptions as indicated below. Check you are using the a supported browser.

- 80bit: AES256/AES128/3DES
- 112bit: AES256/AES128/3DES
- 128bit: AES256/AES128
- 192bit: AES256
- 256bit: AES256

■ CA-signed Certificate is expired.

Solutions

If there is a problem with the expiration date of the certificate, "The certificate has expired" is displayed when connecting to Web Config with SSL/TLS communication (https). If the message appears before its expiration date, make sure that the scanner's date is configured correctly.

■ The common name of the certificate and the scanner do not match.

Solutions

If the common name of the certificate and the scanner do not match, the message "The name of the security certificate does not match..." is displayed when accessing Web Config using SSL/TLS communication (https). This happens because the following IP addresses do not match.

- The scanner's IP address entered to common name for creating a Self-signed Certificate or CSR
- IP address entered to web browser when running Web Config

For Self-signed Certificate, update the certificate.

For CA-signed Certificate, take the certificate again for the scanner.

■ The proxy server setting of local address is not set to web browser.

Solutions

When the scanner is set to use a proxy server, configure the web browser not to connect to the local address via the proxy server.

- Windows:

Select **Control Panel > Network and Internet > Internet Options > Connections > LAN settings > Proxy server**, and then configure not to use the proxy server for LAN (local addresses).

Mac OS:

Select **System Preferences** (or **System Settings**) > **Network** > **Advanced** > **Proxies**, and then register the local address for **Bypass proxy settings for these Hosts & Domains**.

Example:

192.168.1.*: Local address 192.168.1.XXX, subnet mask 255.255.255.0

192.168.*.*: Local address 192.168.XXX.XXX, subnet mask 255.255.0.0

DHCP is disabled in the computer's settings.

Solutions

If the DHCP for obtaining an IP address automatically is disabled on the computer, you may not be able to access Web Config. Enable DHCP.

Example for Windows 10:

Open the Control Panel and then click **Network and Internet** > **Network and Sharing Center** > **Change adapter settings**. Open the Properties screen of the connection you are using, and then open the properties screen for **Internet Protocol Version 4 (TCP/IPv4)** or **Internet Protocol Version 6 (TCP/IPv6)**. Check that **Obtain an IP address automatically** is selected on the displayed screen.

Problems Starting Scanning

Cannot Start Scanning from Computer

Make sure the computer and the scanner are connected correctly.

The cause and solution to the problem differ depending on whether or not they are connected.

Checking the Connection Status (Windows)

Use the Epson Scan 2 Utility to check the connection status.

Note:

Epson Scan 2 Utility is an application supplied with the scanner software.

1. Start the Epson Scan 2 Utility.

Windows 11

Click the start button, and then select **All apps** > **EPSON** > **Epson Scan 2 Utility**.

Windows 10

Click the start button, and then select **EPSON** > **Epson Scan 2 Utility**.

Windows 8.1/Windows 8

Enter the application name in the search charm, and then select the displayed icon.

Windows 7

Click the start button, and then select **All Programs** or **Programs** > **EPSON** > **Epson Scan 2** > **Epson Scan 2 Utility**.

2. On the **Epson Scan 2 Utility** screen, open the **Scanner** list, and then click **Settings** to open the **Scanner Settings** screen.

If the **Scanner Settings** screen is already displayed instead of the **Epson Scan 2 Utility** screen, go to the next.

3. If the scanner is not displayed on the **Scanner Settings** screen, your scanner is not detected.

Click **Add**, and then add your scanner on the **Add Network Scanner** screen.

If you cannot search for the scanner or cannot scan even if the correct scanner is selected, see the related information.

Related Information

- ➔ [“Cannot connect to a Network” on page 180](#)
- ➔ [“The Scanner Cannot Connect by USB” on page 183](#)
- ➔ [“Cannot Scan Even Though a Connection has been Correctly Established” on page 184](#)

Checking the Connection Status (Mac OS)

Use Epson Scan 2 Utility to check the connection status.

Note:

Epson Scan 2 Utility is an application supplied with the scanner software.

1. Start the Epson Scan 2 Utility.

Select **Go > Applications > Epson Software > Epson Scan 2 Utility**.

2. On the **Epson Scan 2 Utility** screen, open the **Scanner** list, and then click **Settings** to open the **Scanner Settings** screen.

If the **Scanner Settings** screen is already displayed instead of the **Epson Scan 2 Utility** screen, go to the next

3. If the scanner is not displayed on the **Scanner Settings** screen, your scanner is not detected.

Click the  icon, and then allow the software to make changes.

4. Click the  icon, and then add your scanner on the **Add Network Scanner** screen.

If you cannot search for the scanner or cannot scan even if the correct scanner is selected, see the related information.

Related Information

- ➔ [“Cannot connect to a Network” on page 180](#)
- ➔ [“The Scanner Cannot Connect by USB” on page 183](#)
- ➔ [“Cannot Scan Even Though a Connection has been Correctly Established” on page 184](#)

Cannot connect to a Network

The problem could be one of the following issues.

Something is wrong with the network devices for Wi-Fi connection.

Solutions

Turn off the devices you want to connect to the network. Wait for about 10 seconds, and then turn on the devices in the following order; wireless router, computer or smart device, and then scanner. Move the scanner and computer or smart device closer to the wireless router to help with radio wave communication, and then try to make network settings again.

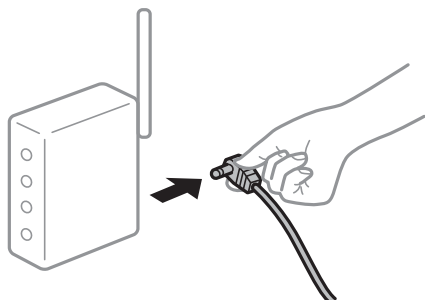

Devices cannot receive signals from the wireless router because they are too far apart.

Solutions

After moving the computer or the smart device and the scanner closer to the wireless router, turn off the wireless router, and then turn it back on.

When changing the wireless router, the settings do not match the new router.

Solutions

Make the connection settings again so that they match the new wireless router.

➔ [“When Replacing the Wireless Router” on page 206](#)

The SSIDs connected from the computer or smart device and computer are different.

Solutions

When you are using multiple wireless routers at the same time or the wireless router has multiple SSIDs and devices are connected to different SSIDs, you cannot connect to the wireless router.

Connect the computer or smart device to the same SSID as the scanner.

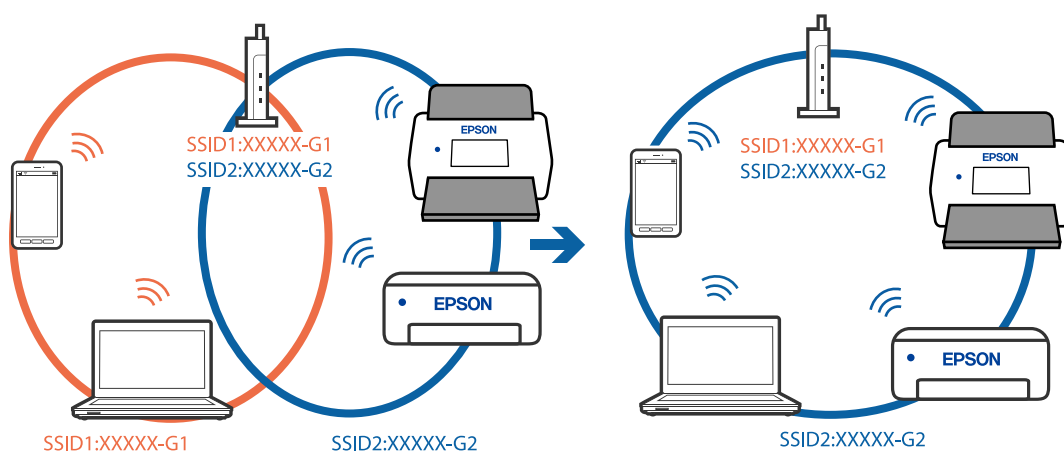

■ A privacy separator on the wireless router is available.

Solutions

Most wireless routers have a privacy separator feature that blocks communication between connected devices. If you cannot communicate between the scanner and the computer or smart device even if they are connected to the same network, disable the privacy separator on the wireless router. See the manual provided with the wireless router for details.

■ The IP address is incorrectly assigned.

Solutions

If the IP address assigned to the scanner is 169.254.XXX.XXX, and the subnet mask is 255.255.0.0, the IP address may not be assigned correctly.

Select **Settings - Network Settings - Advanced - TCP/IP** on the scanner's control panel, and then check the IP address and the subnet mask assigned to the scanner.

Restart the wireless router or reset the network settings for the scanner.

➔ [“Re-setting the Network Connection” on page 206](#)

■ There is a problem with the network settings on the computer.

Solutions

Try accessing any website from your computer to make sure that your computer's network settings are correct. If you cannot access any website, there is a problem on the computer.

Check the network connection of the computer. See the documentation provided with the computer for details.

■ The scanner has been connected by Ethernet using devices that support IEEE802.3az (Energy Efficient Ethernet).

Solutions

When you connect the scanner by Ethernet using devices that support IEEE802.3az (Energy Efficient Ethernet), the following problems may occur depending on the hub or router that you are using.

- Connection becomes unstable, the scanner is connected and disconnected again and again.
- Cannot connect to the scanner.
- The communication speed becomes slow.

Follow the steps below to disable IEEE802.3az for the scanner and then connect.

1. Remove the Ethernet cable connected to the computer and the scanner.
2. When IEEE802.3az for the computer is enabled, disable it.
See the documentation provided with the computer for details.
3. Connect the computer and the scanner with an Ethernet cable directly.
4. On the scanner, check the network settings.
Select **Settings > Network Settings > Network Status > Wired LAN/Wi-Fi Status**.
5. Check the scanner's IP address.

6. On the computer, access Web Config.
Launch a Web browser, and then enter the scanner's IP address.
[“How to Run Web Config in a Web Browser” on page 34](#)
7. Select the **Network** tab > **Wired LAN**.
8. Select **OFF** for **IEEE 802.3az**.
9. Click **Next**.
10. Click **OK**.
11. Remove the Ethernet cable connected to the computer and the scanner.
12. If you disabled IEEE802.3az for the computer in step 2, enable it.
13. Connect the Ethernet cables that you removed in step 1 to the computer and the scanner.
If the problem still occurs, devices other than the scanner may be causing the problem.

■ **The scanner is off.**

Solutions

Make sure the scanner is turned on.

Also, wait until the status light stops flashing indicating that the scanner is ready to scan.

The Scanner Cannot Connect by USB

The following causes can be considered.

■ **The USB cable is not plugged into the electrical outlet correctly.**

Solutions

Connect the USB cable securely to the scanner and the computer.

■ **There is a problem with the USB hub.**

Solutions

If you are using a USB hub, try to connect the scanner directly to the computer.

■ **There is a problem with the USB cable or the USB inlet.**

Solutions

If the USB cable cannot be recognized, change the port, or change the USB cable.

■ **The scanner is off.**

Solutions

Make sure the scanner is turned on.

Also, wait until the status light stops flashing indicating that the scanner is ready to scan.

Cannot Scan Even Though a Connection has been Correctly Established

Required applications are not installed on your computer.

Solutions

Make sure the following applications are installed:

- Document Capture Pro (Windows) or Document Capture (Mac OS)
- Epson Scan 2

If the applications are not installed, install them again.

➔ [“Installing Your Applications” on page 200](#)

Job is not assigned to the scanner's control panel.

Solutions

Check that the job is correctly assigned to the scanner's control panel in Document Capture Pro (Windows) or Document Capture (Mac OS).

➔ [“Creating a Job and Assigning a Job to the Control Panel \(Windows\)” on page 117](#)

If you are using any TWAIN-compliant programs, the correct scanner is not selected as the source setting. (Windows)

Solutions

Make sure that you select the correct scanner from your programs list.

Network Scanning Settings are Disabled

Solutions

In Web Config, select the **Scan** tab > **Network Scan**, and then select **Enable scanning** in **Epson Scan 2**.

AirPrint is disabled.

Solutions

Enable the AirPrint setting in Web Config.

Cannot Start Scanning from Smart Device

Make sure the smart device and the scanner are connected correctly.

The cause and solution to the problem differ depending on whether or not they are connected.

Checking the Connection Status (Smart Device)

You can use Epson Smart Panel to check the connection status for the smart device and the scanner.

1. Start Epson Smart Panel on your smart device.

2. Check whether or not the scanner name is displayed in Epson Smart Panel.

If the scanner name is displayed, a connection has been successfully established between the smart device and the scanner.

If a message is displayed saying that the scanner is not selected, a connection has not been established between the smart device and the scanner. Follow the instructions on the Epson Smart Panel to connect to the scanner.

If you cannot connect to the scanner over a network, check the Related Information.

Related Information

➔ [“Cannot connect to a Network” on page 185](#)

Cannot connect to a Network

The problem could be one of the following issues.

■ Something is wrong with the network devices for Wi-Fi connection.

Solutions

Turn off the devices you want to connect to the network. Wait for about 10 seconds, and then turn on the devices in the following order; wireless router, computer or smart device, and then scanner. Move the scanner and computer or smart device closer to the wireless router to help with radio wave communication, and then try to make network settings again.

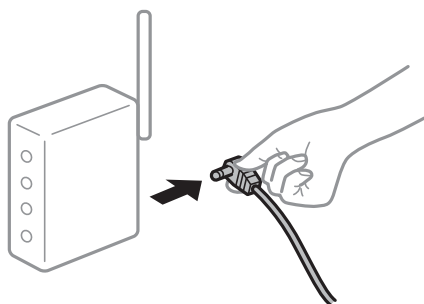

■ Devices cannot receive signals from the wireless router because they are too far apart.

Solutions

After moving the computer or the smart device and the scanner closer to the wireless router, turn off the wireless router, and then turn it back on.

■ When changing the wireless router, the settings do not match the new router.

Solutions

Make the connection settings again so that they match the new wireless router.

➔ [“When Replacing the Wireless Router” on page 206](#)

■ The SSIDs connected from the computer or smart device and computer are different.

Solutions

When you are using multiple wireless routers at the same time or the wireless router has multiple SSIDs and devices are connected to different SSIDs, you cannot connect to the wireless router.

Connect the computer or smart device to the same SSID as the scanner.

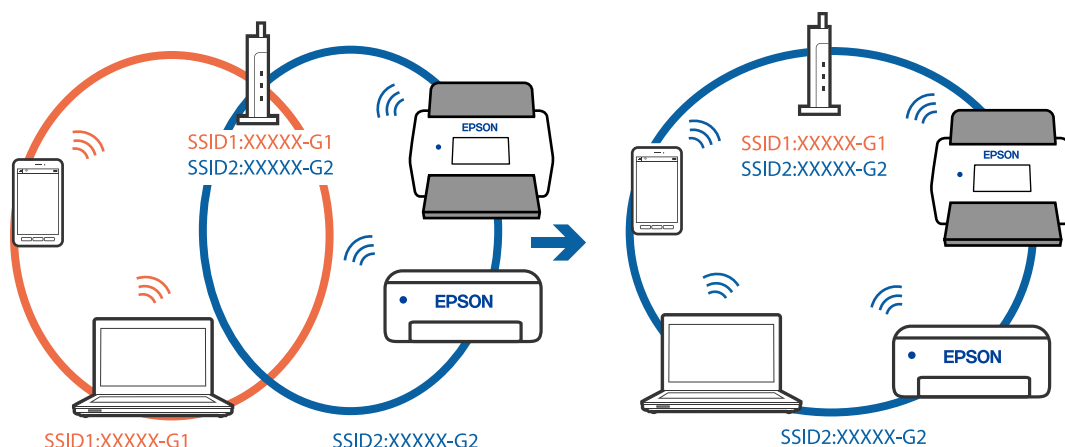

■ **A privacy separator on the wireless router is available.**

Solutions

Most wireless routers have a privacy separator feature that blocks communication between connected devices. If you cannot communicate between the scanner and the computer or smart device even if they are connected to the same network, disable the privacy separator on the wireless router. See the manual provided with the wireless router for details.

■ **The IP address is incorrectly assigned.**

Solutions

If the IP address assigned to the scanner is 169.254.XXX.XXX, and the subnet mask is 255.255.0.0, the IP address may not be assigned correctly.

Select **Settings - Network Settings - Advanced - TCP/IP** on the scanner’s control panel, and then check the IP address and the subnet mask assigned to the scanner.

Restart the wireless router or reset the network settings for the scanner.

➔ [“Re-setting the Network Connection” on page 206](#)

■ **There is a problem with the network settings on the smart device.**

Solutions

Try accessing any website from your smart device to make sure that your smart device’s network settings are correct. If you cannot access any website, there is a problem on the smart device.

Check the network connection of the computer. See the documentation provided with the smart device for details.

■ **The scanner is off.**

Solutions

Make sure the scanner is turned on.

Also, wait until the status light stops flashing indicating that the scanner is ready to scan.

Cannot Save Scanned Images to the Shared Folder

Messages are Displayed on the Control Panel when Scanning to a Network Folder

When error messages are displayed on the control panel, check the message itself or the following list to solve the problems.

Messages	Solutions
DNS error. Check DNS settings.	<p>Cannot connect to the computer. Check the following.</p> <ul style="list-style-type: none"> <input type="checkbox"/> Make sure that the address in the contacts list on the scanner and the address of the shared folder are the same. <input type="checkbox"/> If the IP address of the computer is static and is set manually, change the computer name in the network path to the IP address. Example: \\EPSON02\SCAN to \\192.168.xxx.xxx\SCAN <input type="checkbox"/> Make sure that the computer is turned on and does not sleep. If the computer sleeps, you cannot save scanned images to the shared folder. <input type="checkbox"/> Temporarily disable the computer's Firewall and security software. If this clears the error, check the settings in the security software. <input type="checkbox"/> If Public network is selected as the network place, you cannot save the scanned images to the shared folder. Set the forward settings for each port. <input type="checkbox"/> If you are using a laptop computer and the IP address is set as DHCP, the IP address may change when reconnecting to the network. Obtain the IP address again. <input type="checkbox"/> Make sure the DNS setting is correct. Contact your network administrator about the DNS settings. <input type="checkbox"/> The computer name and the IP address may differ when the management table of the DNS server is not updated. Contact your DNS server administrator.
Authentication error. Check the location, user name and password.	<p>Make sure the user name and the password are correct on the computer and the contacts on the scanner. Also, make sure that the password has not expired.</p>
Communication error. Check the Wi-Fi/network connection.	<p>Cannot communicate with a network folder that is registered on the contacts list. Check the following.</p> <ul style="list-style-type: none"> <input type="checkbox"/> Make sure that the address in the contacts list on the scanner and the address of the shared folder are the same. <input type="checkbox"/> Access rights for the user in the contacts list should be added on the Sharing tab and the Security tab of the shared folder's properties. Also, the permissions for the user should be set to "allowed".
The file name is already in use. Rename the file and scan again.	<p>Change the file name settings. Otherwise, move or delete the files, or change the file name on the shared folder.</p>
Scanned file(s) are too large. Only XX page(s) have been sent. Check if the destination has enough space.	<p>There is not enough disk space on the computer. Increase the free space on the computer.</p>

Checking the Point where the Error Occurred

When saving scanned images to the shared folder, saving process proceeds as following. You can then check the point where the error occurred.

Items	Operation	Error Messages
Connecting	Connect to the computer from the scanner.	DNS error. Check DNS settings.
Logging on to the computer	Log on to the computer with the user name and the password.	Authentication error. Check the location, user name and password.
Checking the folder to save	Check the network path of the shared folder.	Communication error. Check the Wi-Fi/ network connection.
Checking the file name	Check if there is a file with the same name as the file you want to save in the folder.	The file name is already in use. Rename the file and scan again.
Writing the file	Write a new file.	Scanned file(s) are too large. Only XX page(s) have been sent. Check if the destination has enough space.

Saving the Scanned Images Takes a Long Time

It takes a long time for the name resolution to correspond to the "Domain Name" and the "IP Address".

Solutions

Check the following points.

- Make sure the DNS setting is correct.
- Make sure each DNS setting is correct when checking the Web Config.
- Make sure the DNS domain name is correct.

Cannot Send Scanned Images to the Cloud

- When using the Scan to Cloud feature, see the troubleshooting page on the Epson Connect website for details.
<https://www.epsonconnect.com/> > **Learn More** on the Scan to Cloud feature > Contents pull down list > Troubleshooting for Epson Connect Services > Scan to Cloud feature
- Make sure you enter the correct information when you login.
- Make sure the service is running. The service may be down due to system maintenance. Check the accounting service website for more detailed information.

Cannot Send Scanned Images to an Email

- Make sure that the entered email address is working.
- Make sure that the email server settings are correct.
- Contact the email server administrator to make sure the server is running.

Related Information

➔ [“Checking an Email Server Connection” on page 124](#)

Paper Feeding Problems

Multiple Originals Are Fed (Double Feed)

Check the following when a double feed occurs.

- When originals are jammed inside the scanner, open the scanner cover and remove the originals, and then close the scanner cover.
- Check the scanned image, and then scan the originals again if necessary.

If multiple originals are fed frequently, try the following.

- If you load unsupported originals, the scanner may feed multiple originals at a time.
- Clean the rollers inside the scanner.
- Reduce the number of originals being placed at a time.
- Select **Slow** on the control panel to slow down the scanning speed.
- Use **Automatic Feeding Mode**, and scan originals one by one.

When you are using Document Capture Pro, you can open the Epson Scan 2 window by pressing the **Detailed Settings** button on the **Scan Settings** screen.

Related Information

- ➔ [“Scanning in Automatic Feeding Mode” on page 118](#)
- ➔ [“Cleaning Inside the Scanner” on page 161](#)
- ➔ [“Removing Jammed Originals from the Scanner” on page 189](#)

Removing Jammed Originals from the Scanner

If an original has jammed inside the scanner, follow these steps to remove it.

Note:

Epson Smart Panel does not support scanning for long paper (393.8 mm (15.5 in.) or more).

1. Remove all originals remaining in the input tray.
2. Pull the lever and open the scanner cover.

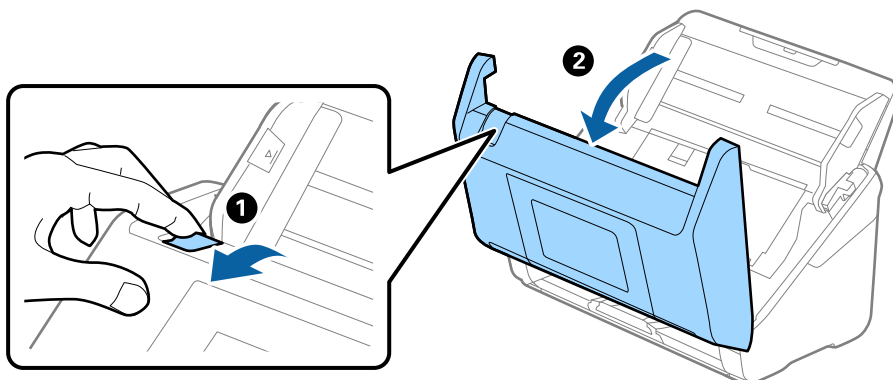

- Carefully remove any originals remaining inside the scanner.

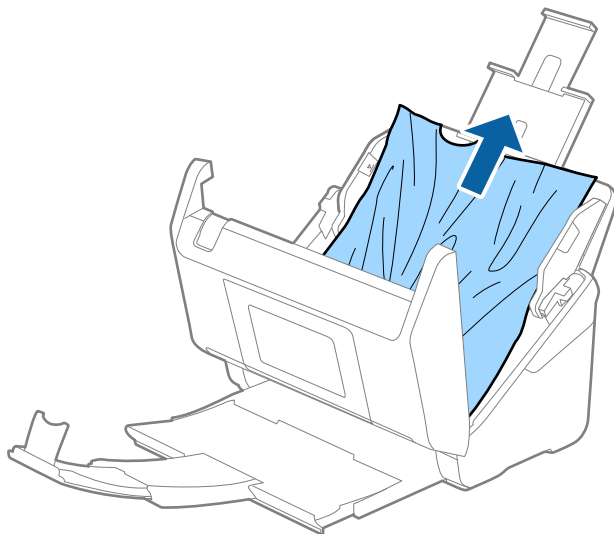

- If you cannot pull originals straight up, carefully pull out any jammed originals from the output tray in the direction of the arrow.

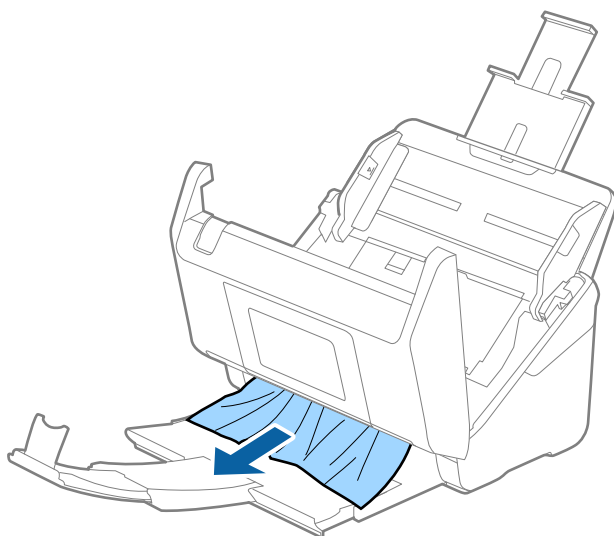

Important:

Make sure there is no paper inside the scanner.

- Close the scanner cover.

Related Information

- ➔ [“Multiple Originals Are Fed \(Double Feed\)” on page 189](#)
- ➔ [“Paper Protection Does not Work Correctly” on page 192](#)
- ➔ [“Paper Jams, Paper Feed Errors, and Document Protection Issues Occur Frequently” on page 191](#)

Paper Jams, Paper Feed Errors, and Document Protection Issues Occur Frequently

If the following problems occur, check the original and the status of the scanner.

- Originals jam frequently
- Paper feed errors occur frequently
- Document protection issues occur frequently

Points to check when loading originals

- For originals with folds or that are curled, flatten the original before loading.
- When loading originals with a mixture of different sizes, load the originals with the side to be scanned facing down and in descending order of paper size with the widest at the back and the narrowest at the center of the input tray. Next, slide the edge guides to align them with the widest originals.

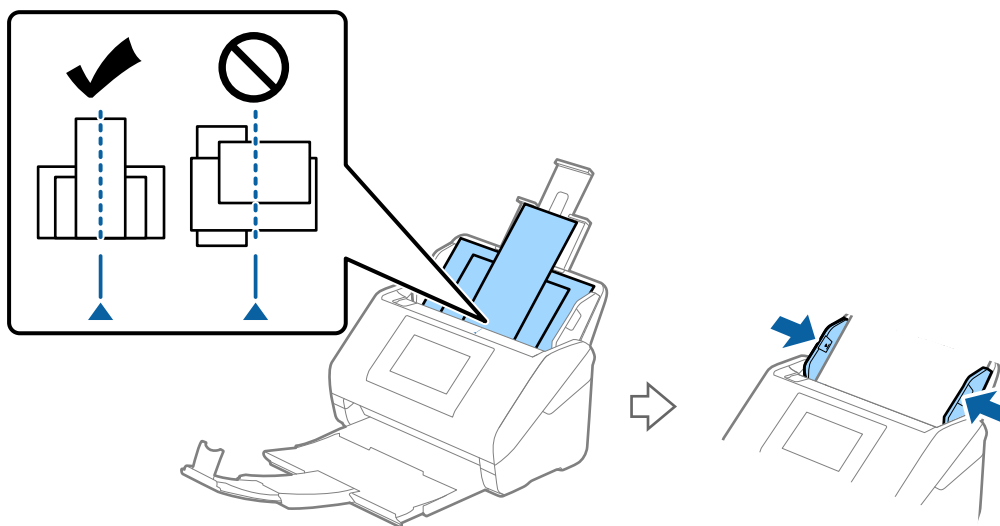

[“Mixture of Originals” on page 72](#)

If the problem is not solved, try scanning the originals at each size separately, or scan the originals one by one. Align the edge guides to the width of the originals each time you load them.

Note:

You can use the following methods to scan the originals multiple times separately and then save them to one file.

- When you are using Epson Scan 2, select **Add or edit pages after scanning** checkbox, and then scan the original. You can add different originals or edit (rotate, move, and delete) the scanned pages after scanning. See the Epson Scan 2 help for details.
- When you are using Document Capture Pro, you can add and edit pages after scanning on the **Edit Scanned Results** screen. See the Document Capture Pro help for details.
- When you are using Epson Smart Panel, load the next original, and then tap **+Scan** after scanning the first page to display the Edit screen. You can rotate, move, and delete pages on the Edit screen.
- When you are scanning from the control panel (Scan to Features), set Automatic Feeding Mode to **On (Semi-Auto)**, and then scan the originals in the order you want to save them.

However, when you scan the originals and save to computer (Scan to Computer), you need to make the job settings. See the Document Capture Pro help for details.

- Enable Slow Mode to slow down the paper feeding speed. Select  > **Slow**.
- After scanning, remove the original from the output tray.

Points to check on the scanner

- Clean the rollers inside the scanner.
[“Cleaning Inside the Scanner” on page 161](#)
- Check the number of sheets scanned by the pickup roller. If the number of scans exceeds the pickup roller's service life (200,000 sheets), replace the roller assembly kit with a new one.
Even if the number of scans does not exceed the pickup roller's service life, we recommend replacing the roller assembly kit with a new one if the surface of the roller is worn out.
[“Replacing the Roller Assembly Kit” on page 166](#)

Note:

You can check the number of scans by the pickup roller on the control panel or in the Epson Scan 2 Utility.

To check from the control panel, tap **Scanner Maintenance** > **Roller Replacement** on the Home screen, and then check the number of scans displayed.

To check from the Epson Scan 2 Utility, start the Epson Scan 2 Utility, click the **Counter** tab, and then check the **Number of Scans** in **Roller Assembly Kit**.

Related Information

- ➔ [“Types of Originals that Require Attention” on page 46](#)
- ➔ [“Placing a Mixture of Originals at Different Sizes” on page 73](#)
- ➔ [“Cleaning Inside the Scanner” on page 161](#)
- ➔ [“Multiple Originals Are Fed \(Double Feed\)” on page 189](#)
- ➔ [“Paper Protection Does not Work Correctly” on page 192](#)

Paper Protection Does not Work Correctly

Depending on the original and the level you set, this feature may not work correctly.

- Select **Off** to disable the feature when scanning plastic cards or thick paper.
- When misdetection occurs frequently, lower the level of this feature.
- If your original is damaged, check that this feature is enabled. If it is already enabled, increase the level of protection for the feature.

Related Information

- ➔ [“Scanner Settings” on page 152](#)
- ➔ [“Removing Jammed Originals from the Scanner” on page 189](#)

Originals are not Ejected Neatly

If originals are not ejected neatly, make sure you extend the output tray extensions so that they are a little bit longer than the length of the originals, and raise the stopper so that the ejected originals can be stacked neatly on the output tray.

Also, when loading A4 size originals, extend the output tray as shown in the following image.

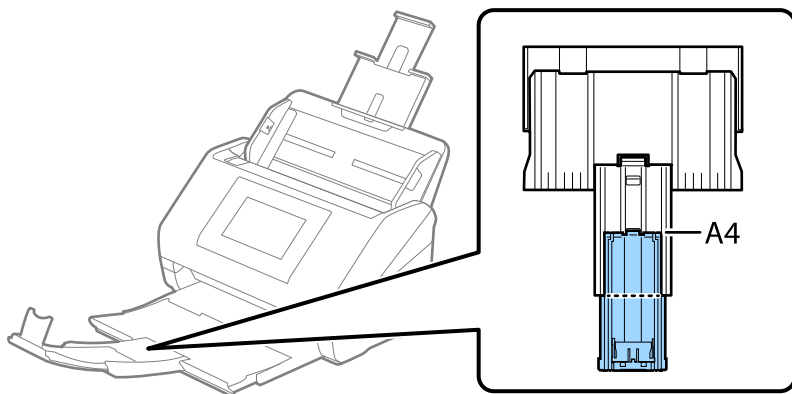

When scanning originals that are a mixture of different sizes, you can improve the alignment of ejected originals by using the optional or supplied Paper Alignment Plate. One is supplied with the DS-900WN.

Related Information

➔ [“Paper Alignment Plate Codes” on page 38](#)

The Originals Get Dirty

Clean the inside of the scanner.

Related Information

➔ [“Cleaning Inside the Scanner” on page 161](#)

Scanning Speed Slows Down when Scanning Continuously

When scanning continuously using the ADF, scanning slows down to prevent the scanner mechanism from overheating and being damaged. However, you can continue scanning.

To regain normal scanning speed, leave the scanner idle for at least 30 minutes. Scanning speed does not recover even if the power is off.

Scanning Takes a Long Time

- ❑ The scanning speed may slow down depending on the scanning conditions, such as high resolution, image adjustment features, file format, communication mode, and so on.
- ❑ Computers with USB 3.0 (SuperSpeed) or USB 2.0 (Hi-Speed) ports can scan faster than those with USB 1.1 ports. If you are using a USB 3.0 or USB 2.0 port with the scanner, make sure it meets the system requirements.
- ❑ When using security software, exclude the TWAIN.log file from monitoring, or set the TWAIN.log as a read-only file. For more information on your security software's functions, see the help and so on supplied with the software. The TWAIN.log file is saved in the following locations.

C:\Users*(user name)*\AppData\Local\Temp

Scanned Image Problems

Lines (Streaks) Appear when Scanning from ADF

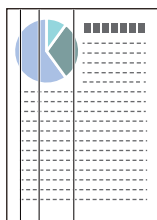

- Clean the ADF.

Straight lines (streaks) may appear in the image when debris or dirt gets into the ADF.

- Remove any debris or dirt that adheres to the original.

- Using **Glass Dirt Detection** feature, a notification is displayed when dirt is detected on the scanner glass inside the scanner.

Select **Settings** on the home screen > **Scanner Settings** > **Glass Dirt Detection**, and then select **On-Low** or **On-High**.

When an alert is displayed, clean the glass surfaces inside your scanner using a genuine Epson cleaning kit or a soft cloth.

[“Cleaning Inside the Scanner” on page 161](#)

Note:

- Some stains may not be detected correctly.*

- If the detection does not work correctly, change the setting.*

*If no stains are detected, select **On-High**. If stains are detected incorrectly, select **On-Low** or **Off**.*

Related Information

➔ [“Cleaning Inside the Scanner” on page 161](#)

Alert About Stains Inside the Scanner Still Appears

If the alert screen appears after cleaning the inside of the scanner, glass part will be required to replace. Contact your local dealer to repair.

Related Information

➔ [“Cleaning Inside the Scanner” on page 161](#)

Colors Are Uneven in the Scanned Image

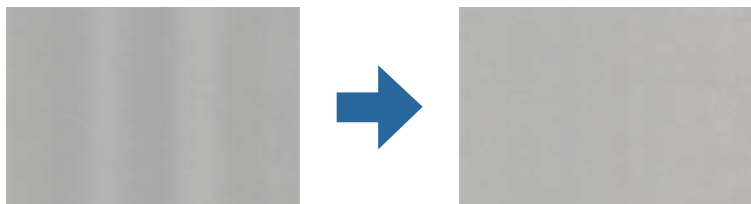

If the scanner is subject to strong light such as direct sunlight, the sensor inside the scanner misdetects the light and colors in the scanned image become uneven.

- Change the orientation of the scanner so that no strong light is falling on the front of the scanner.
- Move the scanner to a location where it will not be subjected to strong light.

Expanding or Contracting the Scanned Image

When expanding or contracting the scanned image, you can adjust the expansion ratio by using the **Adjustments** feature in Epson Scan 2 Utility. This feature is only available for Windows.

Note:

Epson Scan 2 Utility is one of the applications supplied with the scanner software.

1. Start Epson Scan 2 Utility.
 - Windows 11/Windows Server 2019/Windows Server 2022
Click the start button, and then select **All apps > EPSON > Epson Scan 2 Utility**.
 - Windows 10/Windows Server 2016
Click the start button, and then select **EPSON > Epson Scan 2 Utility**.
 - Windows 8.1/Windows 8/Windows Server 2012 R2/Windows Server 2012
Enter the application name in the search charm, and then select the displayed icon.
 - Windows 7/Windows Server 2008 R2
Click the start button, and then select **All Programs or Programs > EPSON > Epson Scan 2 > Epson Scan 2 Utility**.
2. Select the **Adjustments** tab.
3. Use **Expansion/Contraction** to adjust the expansion ratio for scanned images.
4. Click **Set** to apply the settings to the scanner.

An Image on the Back of Your Original Appears in Your Scanned Image

Images on the back of the original may appear in the scanned image.

- When **Auto**, **Color**, or **Grayscale** is selected as the **Image Type**:
 - Check that **Remove Background** is selected.

Control panel: Enable **Remove Background** in Scan Settings.

Document Capture Pro (Windows)/Document Capture (Mac OS X): Press the **Detailed Settings** button on the **Scan Settings** screen to open the Epson Scan 2 screen. Click the **Advanced Settings** tab > **Remove Background**.

Epson Scan 2: On the **Advanced Settings** tab, select **Remove Background**.
 - Check that **Text Enhancement** is selected.

Control panel: Enable **Text Enhancement** in Scan Settings.

Document Capture Pro (Windows)/Document Capture (Mac OS X): On the **Scan Settings** screen, select **Text Enhancement**.

Epson Scan 2: On the **Advanced Settings** tab, select **Text Enhancement**.
- When you select **Black & White** from **Image Type**:

Check that **Text Enhancement** is selected.

Control panel: Enable **Text Enhancement** in Scan Settings.

Document Capture Pro (Windows)/Document Capture (Mac OS X): On the **Scan Settings** screen, select **Text Enhancement**.

Epson Scan 2: On the **Advanced Settings** tab, select **Text Enhancement**.

Depending on the condition of your scanned image, click **Settings**, and then move the slider towards **Remove background**.

Scanned Text or Images are Missing or Blurred

You can adjust the appearance of the scanned image or text by increasing the resolution or adjusting the image quality.

- Change the resolution, and then scan again.

Set the appropriate resolution for the purpose of your scanned image.
- Check that **Text Enhancement** is selected.

Control panel: Enable **Text Enhancement** in Scan Settings.

Document Capture Pro (Windows)/Document Capture (Mac OS X): On the **Scan Settings** screen, select **Text Enhancement**.

Epson Scan 2: On the **Advanced Settings** tab, select **Text Enhancement**.

When you select **Black & White** as the **Image Type**, depending on the condition of the scanned image, click **Settings** and adjust the slider for **Emphasize light letters / Remove background**, turn off **Remove spot noise**, or set the level to **Low**.
- If you are scanning in JPEG format, try changing the compression level.

Document Capture Pro (Windows)/Document Capture (Mac OS X): Click **Option** on the **Save Settings** screen to change the JPEG quality.

Epson Scan 2: Click **Image Format** > **Options**, and then change the **Image Quality**.

List of Recommended Resolutions to Suit Your Purpose

See the table and set the appropriate resolution for the purpose of your scanned image.

Purpose	Resolution (Reference)
Displaying on a screen Sending by email	Up to 200 dpi
Using Optical Character Recognition (OCR) Creating a text searchable PDF	200 to 300 dpi
Printing using a printer Sending by fax	200 to 300 dpi

Moiré Patterns (Web-Like Shadows) Appear

If the original is a printed document, moiré patterns (web-like shadows) may appear in the scanned image.

- ❑ Check that **Descreening** is selected in the Epson Scan 2 window. When you are using Document Capture Pro, you can open the window by pressing the **Detailed Settings** button on the **Scan Settings** screen.

Click the **Advanced Settings** tab > **Descreening**.



- ❑ Change the resolution, and then scan again.

The Edge of the Original is Not Scanned when Automatically Detecting the Size of the Original

Depending on the original, the edge of the original may not be scanned when automatically detecting the size of the original.

- ❑ Adjust **Crop Margins for Size "Auto"** in the Epson Scan 2 window. When you are using Document Capture Pro, you can open the window by pressing the **Detailed Settings** button on the **Scan Settings** screen.
Click the **Main Settings** tab > **Document Size** > **Settings**. On the **Document Size Settings** screen, adjust **Crop Margins for Size "Auto"**.
- ❑ Depending on the original, the area of the original may not be detected correctly when using the **Auto Detect** feature. Select the appropriate size of the original from the **Document Size** list.

Note:

*If the size of the original you want to scan is not on the list, create the size manually in the Epson Scan 2 window. When you are using Document Capture Pro, you can open the window by pressing the **Detailed Settings** button on the **Scan Settings** screen.*

*Click the **Main Settings** tab > **Document Size**, and then select **Customize**.*

Character is not Recognized Correctly

Check the following to increase the recognition rate of OCR (Optical Character Recognition).

- Check that the original is placed straight.
- Use an original with clear text. Text recognition may decline for the following types of originals.
 - Originals that have been copied many times
 - Originals received by fax (at low resolutions)
 - Originals with tightly spaced characters or line spacing
 - Originals with ruled lines or underlined text
 - Originals with hand-written text
 - Originals with creases or wrinkles
- Paper type made of thermal paper such as receipts may deteriorate due to age or friction. Scan them as soon as possible.
- When saving to Microsoft® Office or **Searchable PDF** files, check that the correct languages are selected.
- If you have set **Image Type** to **Color** or **Grayscale** in Epson Scan 2, try adjusting the **Text Enhancement** setting. Click the **Advanced Settings** tab > **Text Enhancement** > **Settings**, and then select **Emphasize light letters for OCR** as the **Mode**.

Note:

You need the EPSON Scan OCR component to save as a **Searchable PDF**. This is installed automatically when you set up the scanner using the installer.

Cannot Solve Problems in the Scanned Image

If you have tried all of the solutions and have not solved the problem, initialize the scanner driver (Epson Scan 2) settings using Epson Scan 2 Utility.

Note:

Epson Scan 2 Utility is one of the applications supplied with the scanner software.

1. Start Epson Scan 2 Utility.
 - Windows 11/Windows Server 2019/Windows Server 2022
Click the start button, and then select **All apps > EPSON > Epson Scan 2 Utility**.
 - Windows 10/Windows Server 2016
Click the start button, and then select **EPSON > Epson Scan 2 Utility**.
 - Windows 8.1/Windows 8/Windows Server 2012 R2/Windows Server 2012
Enter the application name in the search charm, and then select the displayed icon.
 - Windows 7/Windows Server 2008 R2/Windows Server 2008
Click the start button, and then select **All Programs or Programs > EPSON > Epson Scan 2 > Epson Scan 2 Utility**.
 - Mac OS
Select **Go > Applications > Epson Software > Epson Scan 2 Utility**.
2. Select the **Other** tab.

3. Click **Reset**.

Note:

If initialization does not solve the problem, uninstall and re-install the scanner driver (Epson Scan 2).

Document Capture Pro Problems

For problems that occur when scanning using Document Capture Pro, access the following URL to check the Document Capture Pro manual.

<https://support.epson.net/dcp/>

Uninstalling and Installing Applications

Uninstalling Your Applications

You may need to uninstall and then reinstall your applications to solve certain problems or if you upgrade your operating system. Log on to your computer as an administrator. Enter the administrator password if the computer prompts you.

Uninstalling Your Applications for Windows

1. Quit all running applications.
2. Disconnect the scanner from your computer.
3. Open the Control Panel:
 - Windows 11/Windows Server 2022
Click the start button, and then select **All apps > Windows Tools > Control Panel**.
 - Windows 10/Windows Server 2016/Windows Server 2019
Click the start button, and then select **Windows System > Control Panel**.
 - Windows 8.1/Windows 8/Windows Server 2012 R2/Windows Server 2012
Select **Desktop > Settings > Control Panel**.
 - Windows 7/Windows Server 2008 R2
Click the start button, and then select **Control Panel**.
4. Select **Uninstall a program** in **Programs**.
5. Select the application you want to uninstall.
6. Click **Uninstall/Change** or **Uninstall**.

Note:

If the User Account Control window is displayed, click Continue.

7. Follow the on-screen instructions.

Note:

A message may be displayed prompting you to restart your computer. If it is displayed, make sure **I want to restart my computer now** is selected, and then click **Finish**.

Uninstalling Your Applications for Mac OS

Note:

Make sure you installed EPSON Software Updater.

1. Download the Uninstaller using EPSON Software Updater.
Once you have downloaded the Uninstaller, you do not need to download it again each time you uninstall the application.
2. Disconnect the scanner from your computer.
3. To uninstall the scanner driver, select **System Preferences** from the Apple menu > **Printers & Scanners** (or **Print & Scan, Print & Fax**), and then remove the scanner from the enabled scanner list.
4. Quit all running applications.
5. Select **Go > Applications > Epson Software > Uninstaller**.
6. Select the application you want to uninstall, and then click Uninstall.



Important:

The Uninstaller removes all drivers for Epson scanners on the computer. If you use multiple Epson scanners and you only want to delete some of the drivers, delete all of them first, and then install the necessary scanner drivers again.

Note:

If you cannot find the application you want to uninstall in the application list, you cannot uninstall using the Uninstaller. In this situation, select **Go > Applications > Epson Software**, select the application you want to uninstall, and then drag it to the trash icon.

Installing Your Applications

Follow the steps below to install the necessary applications.

Note:

- Log on to your computer as an administrator. Enter the administrator password if the computer prompts you.
- When reinstalling applications, you need to uninstall them first.

1. Quit all running applications.
2. When installing scanner driver (Epson Scan 2), disconnect the scanner and the computer temporarily.

Note:

Do not connect the scanner and the computer until you are instructed to do so.

3. Install the application by following the instructions on the Website below.

<https://epson.sn>

Adding or Replacing the Computer or Devices

Connecting to a Scanner that has been Connected to the Network.	203
Connecting a Smart Device and Scanner Directly (Wi-Fi Direct).	204
Re-setting the Network Connection.	206
Checking the Network Connection Status.	211

Connecting to a Scanner that has been Connected to the Network

When the scanner has already been connected to the network, you can connect a computer or a smart device to the scanner over the network.

Using a Network Scanner from a Second Computer

We recommend using the installer to connect the scanner to a computer.

To start the installer, access the following website, and then enter the product name. Go to **Setup**, and then start setting up.

<https://epson.sn>

You can view the operating instructions in the Web Movie Manuals. Access the following URL.

<https://support.epson.net/publist/vlink.php?code=NPD7509>

Selecting the Scanner

Follow the on-screen instructions until the following screen is displayed, select the scanner name you want to connect to, and then click **Next**.

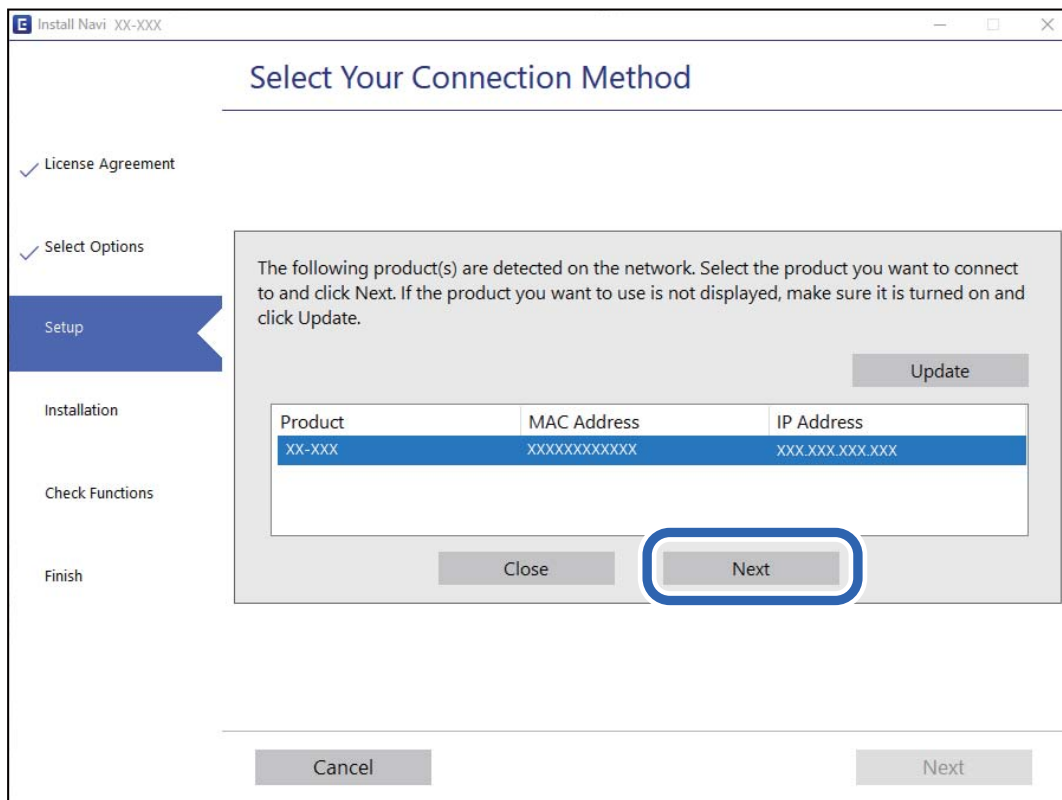

Follow the on-screen instructions.

Using a Network Scanner from a Smart Device

You can connect a smart device to the scanner using one of the following methods.

Connecting over a wireless router

Connect the smart device to the same Wi-Fi network (SSID) as the scanner.

See the following for more details.

[“Making Settings for Connecting to the Smart Device” on page 207](#)

Connecting by Wi-Fi Direct

Connect the smart device to the scanner directly without a wireless router.

See the following for more details.

[“Connecting a Smart Device and Scanner Directly \(Wi-Fi Direct\)” on page 204](#)

Connecting a Smart Device and Scanner Directly (Wi-Fi Direct)

Wi-Fi Direct (Simple AP) allows you to connect a smart device directly to the scanner without a wireless router and scan from the smart device.

About Wi-Fi Direct

Use this connection method when you are not using Wi-Fi at home or at the office, or when you want to connect the scanner and the computer or smart device directly. In this mode, the scanner acts as an wireless router and you can connect up to 8 devices to the scanner without having to use a standard wireless router. However, devices directly connected to the scanner cannot communicate with each other through the scanner.

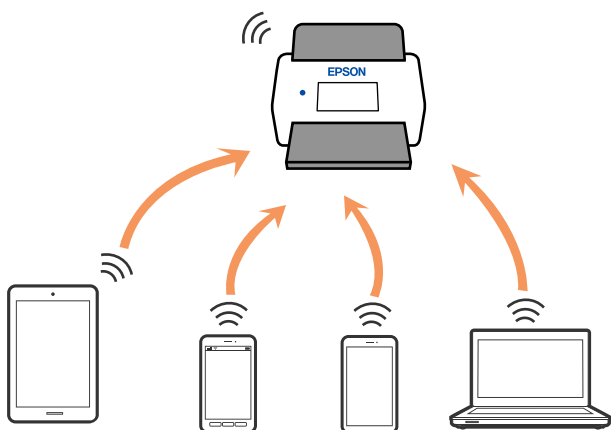

The scanner can be connected by Wi-Fi or Ethernet, and Wi-Fi Direct (Simple AP) connection simultaneously. However, if you start a network connection in Wi-Fi Direct (Simple AP) connection when the scanner is connected by Wi-Fi, the Wi-Fi is temporarily disconnected.

Connecting to a Smart Device using Wi-Fi Direct

This method allows you to connect the scanner directly to smart devices without a wireless router.

1. Select  on the home screen.
2. Select **Wi-Fi Direct**.
3. Select **Start Setup**.
4. Start Epson Smart Panel on your smart device.
5. Follow the instructions displayed on the Epson Smart Panel to connect to your scanner.
When your smart device is connected to the scanner, go to the next step.
6. On the scanner's control panel, select **Complete**.

Disconnecting Wi-Fi Direct (Simple AP) Connection

There are two methods available to disable a Wi-Fi Direct (Simple AP) connection; you can disable all connections by using the scanner's control panel, or disable each connection from the computer or the smart device.

When you want to disable all connections, select  > **Wi-Fi Direct** > **Start Setup** > **Change** > **Disable Wi-Fi Direct**.

Important:

When Wi-Fi Direct (Simple AP) connection disabled, all computers and smart devices connected to the scanner in Wi-Fi Direct (Simple AP) connection are disconnected.

Note:

If you want to disconnect a specific device, disconnect from the device instead of the scanner. Use one of the following methods to disconnect the Wi-Fi Direct (Simple AP) connection from the device.

- Disconnect the Wi-Fi connection to the scanner's network name (SSID).
- Connect to another network name (SSID).

Changing the Wi-Fi Direct (Simple AP) Settings Such as the SSID

When Wi-Fi Direct (simple AP) connection is enabled, you can change the settings from  > **Wi-Fi Direct** > **Start Setup** > **Change**, and then the following menu items are displayed.

Change Network Name

Change the Wi-Fi Direct (simple AP) network name (SSID) used for connecting to the scanner to your arbitrary name. You can set the network name (SSID) in ASCII characters that is displayed on the software keyboard on the control panel. You can enter up to 22 characters.

When changing the network name (SSID), all connected devices are disconnected. Use the new network name (SSID) if you want to re-connect the device.

Change Password

Change the Wi-Fi Direct (simple AP) password for connecting to the scanner to your arbitrary value. You can set the password in ASCII characters that is displayed on the software keyboard on the control panel. You can enter 8 to 22 characters.

When changing the password, all connected devices are disconnected. Use the new password if you want to re-connect the device.

Change Frequency Range

Change the frequency range of Wi-Fi Direct used for connecting to the scanner. You can select 2.4 GHz or 5 GHz.

When changing the frequency range, all connected devices are disconnected. Re-connect the device.

Note that you cannot re-connect from devices that do not support 5 GHz frequency range when changing to 5 GHz.

Depending on the region, this setting may not be displayed.

Disable Wi-Fi Direct

Disable Wi-Fi Direct (simple AP) settings of the scanner. When disabling it, all devices connected to the scanner in Wi-Fi Direct (Simple AP) connection are disconnected.

Restore Default Settings

Restore all Wi-Fi Direct (simple AP) settings to their defaults.

The Wi-Fi Direct (simple AP) connection information of the smart device saved to the scanner is deleted.

Note:

You can also set up from the **Network** tab > **Wi-Fi Direct** on Web Config for the following settings.

- Enabling or disabling Wi-Fi Direct (simple AP)*
- Changing network name (SSID)*
- Changing password*
- Changing the frequency range*
Depending on the region, this setting may not be displayed.
- Restoring the Wi-Fi Direct (simple AP) settings*

Re-setting the Network Connection

This section explains how to make the network connection settings and change the connection method when replacing the wireless router or the computer.

When Replacing the Wireless Router

When you replace the wireless router, make settings for the connection between the computer or the smart device and the scanner.

You need to make these settings if you change your Internet service provider and so on.

Making Settings for Connecting to the Computer

We recommend using the installer to connect the scanner to a computer.

To start the installer, access the following website, and then enter the product name. Go to **Setup**, and then start setting up.

<https://epson.sn>

You can view the operating instructions in the Web Movie Manuals. Access the following URL.

<https://support.epson.net/publist/vlink.php?code=NPD7509>

Selecting a Connection Method

Follow the on-screen instructions. On the **Select Install Option** screen, select **Set up Scanner connection again (for new network router or changing USB to network, etc.)**, and then click **Next**.

Follow the on-screen instructions to finish setup.

If you cannot connect, see the following to try to solve the problem.

[“Cannot connect to a Network” on page 180](#)

Making Settings for Connecting to the Smart Device

You can use the scanner from a smart device when you connect the scanner to the same Wi-Fi network (SSID) as the smart device. To use the scanner from a smart device, access the following website, and then enter the product name. Go to **Setup**, and then start setting up.

<https://epson.sn>

Access to the website from the smart device that you want to connect to the scanner.

When Changing the Computer

When changing the computer, make connection settings between the computer and the scanner.

Making Settings for Connecting to the Computer

We recommend using the installer to connect the scanner to a computer.

To start the installer, access the following website, and then enter the product name. Go to **Setup**, and then start setting up.

<https://epson.sn>

You can view the operating instructions in the Web Movie Manuals. Access the following URL.

<https://support.epson.net/publist/vlink.php?code=NPD7509>

Follow the on-screen instructions.

Changing the Connection Method to the Computer

This section explains how to change the connection method when the computer and the scanner have been connected.

Changing the Network Connection from Ethernet to Wi-Fi

Change the Ethernet connection to Wi-Fi connection from the scanner's control panel. The changing connection method is basically the same as the Wi-Fi connection settings.

Related Information

➔ [“Making Wi-Fi Settings from the Control Panel” on page 208](#)

Changing the Network Connection from Wi-Fi to Ethernet

Follow the steps below to change from a Wi-Fi connection to an Ethernet connection.

1. Select **Settings** on the home screen.
2. Select **Network Settings** > **Wired LAN Setup**.
3. Set each item.

Changing from USB to a Network Connection

Using the installer and re-set up in a different connection method.

Access the following website, and then enter the product name. Go to **Setup**, and then start setting up.

<https://epson.sn>

Selecting Change the Connection Methods

Follow the instructions in each window. On the **Select Install Option** screen, select **Set up Scanner connection again (for new network router or changing USB to network, etc.)**, and then click **Next**.

Select the network connection that you want to use, **Connect via wireless network (Wi-Fi)** or **Connect via wired LAN (Ethernet)**, and then click **Next**.

Follow the on-screen instructions to finish setup.

Making Wi-Fi Settings from the Control Panel

You can make network settings from the scanner's control panel in several ways. Choose the connection method that matches the environment and conditions that you are using.

If you know the information for the wireless router such as SSID and password, you can make settings manually.

If the wireless router supports WPS, you can make settings by using push button setup.

After connecting the scanner to the network, connect to the scanner from the device that you want to use (computer, smart device, tablet, and so on.)

Note when Using a Wi-Fi 5 GHz Connection

This product normally uses W52 (36ch) as the channel when connecting to Wi-Fi Direct (Simple AP). Since the channel for wireless LAN (Wi-Fi) connection is selected automatically, the channel used may differ when used at the same time as a Wi-Fi Direct connection. If the channels differ, data communication with the scanner may be

slow. If it does not interfere with use, connect to the SSID in the 2.4 GHz band. In the 2.4 GHz frequency band, the channels used will match.

When setting the wireless LAN to 5 GHz, we recommend disabling Wi-Fi Direct.

Making Wi-Fi Settings by Entering the SSID and Password

You can set up a Wi-Fi network by entering the information necessary to connect to a wireless router from the scanner's control panel. To set up using this method, you need the SSID and password for a wireless router.

Note:

If you are using a wireless router with its default settings, the SSID and password are on the label. If you do not know the SSID and password, contact the person who set up the wireless router, or see the documentation provided with the wireless router.

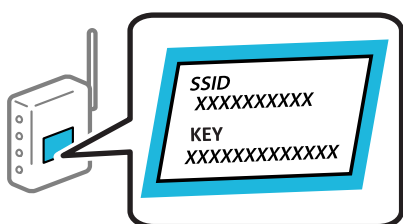

1. Tap  on the home screen.

2. Select **Router**.

3. Tap **Start Setup**.

If the network connection is already set up, the connection details are displayed. Tap **Change to Wi-Fi connection**, or **Change Settings** to change the settings.

4. Select **Wi-Fi Setup Wizard**.

5. Follow the on-screen instructions to select the SSID, enter the password for the wireless router, and start setup.

If you want to check the network connection status for the scanner after setup is complete, see the related information link below for details.

Note:

- If you do not know the SSID, check if it is written on the label of the wireless router. If you are using the wireless router with its default settings, use the SSID written on the label. If you cannot find any information, see the documentation provided with the wireless router.*
- The password is case-sensitive.*
- If you do not know the password, check if the information is written on the label of the wireless router. On the label, the password may be written "Network Key", "Wireless Password", and so on. If you are using the wireless router with its default settings, use the password written on the label.*
- If you cannot see the SSID you want to connect to, use software or an app to set up the Wi-Fi from your computer or smart device, such as a smartphone or tablet. For more information, enter "<https://epson.sn>" in your browser to access the website, enter the name of your product, and go to **Setup**.*

Related Information

➔ [“Checking the Network Connection Status” on page 211](#)

Making Wi-Fi Settings by Push Button Setup (WPS)

You can automatically set up a Wi-Fi network by pressing a button on the wireless router. If the following conditions are met, you can set up by using this method.

- The wireless router is compatible with WPS (Wi-Fi Protected Setup).
- The current Wi-Fi connection was established by pressing a button on the wireless router.

Note:

If you cannot find the button or you are setting up using the software, see the documentation provided with the wireless router.

1. Tap  on the home screen.

2. Select **Router**.

3. Tap **Start Setup**.

If the network connection is already set up, the connection details are displayed. Tap **Change to Wi-Fi connection**, or **Change Settings** to change the settings.

4. Select **Push Button Setup(WPS)**.

5. Follow the on-screen instructions.

If you want to check the network connection status for the scanner after setup is complete, see the related information link below for details.

Note:

If connection fails, restart the wireless router, move it closer to the scanner, and try again.

Related Information

➔ [“Checking the Network Connection Status” on page 211](#)

Making Wi-Fi Settings by PIN Code Setup (WPS)

You can automatically connect to a wireless router by using a PIN code. You can use this method to set up if an wireless router is capable of WPS (Wi-Fi Protected Setup). Use a computer to enter a PIN code into the wireless router.

1. Tap  on the home screen.

2. Select **Router**.

3. Tap **Start Setup**.

If the network connection is already set up, the connection details are displayed. Tap **Change to Wi-Fi connection**, or **Change Settings** to change the settings.

4. Select **Others > PIN Code Setup(WPS)**

5. Follow the on-screen instructions.

If you want to check the network connection status for the scanner after setup is complete, see the related information link below for details.

Note:

See the documentation provided with your wireless router for details on entering a PIN code.

Related Information

➔ [“Checking the Network Connection Status” on page 211](#)

Checking the Network Connection Status

You can check the network connection status in the following way.









Checking the Network Connection Status from the Control Panel

You can check the network connection status using the network icon or the network information on the scanner’s control panel.

Checking the Network Connection Status using the Network Icon

You can check the network connection status and strength of the radio wave using the network icon on the scanner's home screen.



	<p>Displays the network connection status.</p> <p>Select the icon to check and change the current settings. This is the shortcut for the following menu.</p> <p>Settings > Network Settings > Wi-Fi Setup</p>
	<p>The scanner is not connected to a wireless (Wi-Fi) network.</p>
	<p>The scanner is searching for SSID, unset IP address, or having a problem with a wireless (Wi-Fi) network.</p>
	<p>The scanner is connected to a wireless (Wi-Fi) network.</p> <p>The number of bars indicates the signal strength of the connection. The more bars there are, the stronger the connection.</p>
	<p>The scanner is not connected to a wireless (Wi-Fi) network in Wi-Fi Direct (Simple AP) mode.</p>
	<p>The scanner is connected to a wireless (Wi-Fi) network in Wi-Fi Direct (Simple AP) mode.</p>
	<p>The scanner is not connected to a wired (Ethernet) network or unset it.</p>
	<p>The scanner is connected to a wired (Ethernet) network.</p>

Displaying Detailed Network Information on the Control Panel

When your scanner is connected to the network, you can also view other network-related information by selecting the network menus you want to check.

1. Select **Settings** on the home screen.
2. Select **Network Settings > Network Status**.
3. To check the information, select the menus that you want to check.
 - Wired LAN/Wi-Fi Status**
Displays the network information (device name, connection, signal strength, and so on) for Ethernet or Wi-Fi connections.
 - Wi-Fi Direct Status**
Displays whether Wi-Fi Direct is enabled or disabled, and the SSID, password and so on for Wi-Fi Direct connections.
 - Email Server Status**
Displays the network information for email server.

Checking the Network of the Computer (Windows only)

By using the command prompt, check the connection status of the computer and the connection path to the scanner. This will lead you to solve the problems.

ipconfig command

Display the connection status of the network interface that is currently used by the computer.

By comparing the setting information with actual communication, you can check whether the connection is correct. In case there are multiple DHCP servers on the same network, you can find out the actual address assigned to the computer, the referred DNS server, etc.

Format : ipconfig /all

Examples :

```

Administrator: Command Prompt
c:\>ipconfig /all
Windows IP Configuration

Host Name . . . . . : WIN2012R2
Primary Dns Suffix . . . . . : pubs.net
Node Type . . . . . : Hybrid
IP Routing Enabled. . . . . : No
WINS Proxy Enabled. . . . . : No
DNS Suffix Search List. . . . . : pubs.net

Ethernet adapter Ethernet:

Connection-specific DNS Suffix . . . : 
Description . . . . . : Gigabit Network Connection
Physical Address. . . . . : XX-XX-XX-XX-XX-XX
DHCP Enabled. . . . . : No
Autoconfiguration Enabled . . . . . : Yes
Link-local IPv6 Address . . . . . : fe80::38fb:7546:18a8:d20e%14(Preferred)
IPv4 Address. . . . . : 192.168.111.10(Preferred)
Subnet Mask . . . . . : 255.255.255.0
Default Gateway . . . . . : 192.168.111.1
DHCPv6 IAID . . . . . : 283142549
DHCPv6 Client DUID. . . . . : 00-01-00-01-20-40-2F-45-00-1D-73-6A-44-08
DNS Servers . . . . . : 192.168.111.2
NetBIOS over Tcpip. . . . . : Enabled

Tunnel adapter isatap.{00000000-ABCD-EFGH-IJK-LMNOPQRSTUUV}>:

Media State . . . . . : Media disconnected
Connection-specific DNS Suffix . . . : 
Description . . . . . : Microsoft ISATAP Adapter #2
Physical Address. . . . . : 00-00-00-00-00-00-E0
DHCP Enabled. . . . . : No
Autoconfiguration Enabled . . . . . : Yes

c:\>_
    
```

pathping command

You can confirm the list of routers passing through the destination host and the routing of communication.

Format : pathping xxx.xxx.xxx.xxx

Examples : pathping 192.0.2.222

```

Administrator: Command Prompt
c:\>pathping 192.168.111.20
Tracing route to EPSONAB12AB [192.168.111.20]
over a maximum of 30 hops:
 0  WIN2012R2.pubs.net [192.168.111.10]
 1  EPSONAB12AB [192.168.111.20]

Computing statistics for 25 seconds..
Hop  RTT      Source to Here   This Node/Link   Address
 0      0/ 100 = 0%      0/ 100 = 0%      WIN2012R2.pubs.net [192.168.111.10]
 1  38ms     0/ 100 = 0%      0/ 100 = 0%      EPSONAB12AB [192.168.111.20]

Trace complete.

c:\>_
    
```

Technical Specifications

General Scanner Specifications.	215
Network Specifications.	216
Supported Third Party Services.	218
USB Drive Specifications.	218
Using Port for the Scanner.	218
Dimensions and Weight Specifications.	220
Electrical Specifications.	221
Environmental Specifications.	223
System Requirements.	223

General Scanner Specifications

Note:

Specifications are subject to change without notice.

Scanner type	Sheet Feed, one pass duplex color scanner
Photoelectric device	CIS
Effective pixels	5,100×9,300 at 600 dpi 2,550×64,500 at 300 dpi
Light source	RGB LED
Scanning resolution	600 dpi (main scan) 600 dpi (sub scan)
Output resolution	50 to 1200 dpi (in 1 dpi increments) *1
Document Size	Max: 215.9×6,096 mm (8.5×240 inches) *2 Min: 50.8×50.8 mm (2×2 inches)
Paper input	Face-down loading
Paper output	Face-down ejection
Paper capacity	100 sheets of paper at 80 g/m ²
Color Depth	Color <input type="checkbox"/> 30 bits per pixel internal (10 bits per pixel per color internal) <input type="checkbox"/> 24 bits per pixel external (8 bits per pixel per color external) Grayscale <input type="checkbox"/> 10 bits per pixel internal <input type="checkbox"/> 8 bits per pixel external Black and white <input type="checkbox"/> 10 bits per pixel internal <input type="checkbox"/> 1 bit per pixel external
Interface	SuperSpeed USB Hi-Speed USB (Host) IEEE802.11b/g/n or IEEE802.11a/b/g/n/ac *3 Ethernet 1000BASE-T/100BASE-TX/10BASE-T

*1 This value is when scanning with a computer. Available resolutions may vary depending on the scanning method.

*2 Maximum length may vary depending on the scanning method and the resolution. See the following for more details.

[“Maximum Length for Long Paper” on page 43](#)

*3 Available Wi-Fi interfaces vary depending on your region.

Network Specifications

Wi-Fi Specifications

See the following table for Wi-Fi specifications.

Countries or regions except for those listed below	Table A
Ireland, United Kingdom, Austria, Germany, Liechtenstein, Switzerland, France, Belgium, Luxembourg, Netherlands, Italy, Portugal, Spain, Denmark, Finland, Norway, Sweden, Iceland, Croatia, Cyprus, Greece, North Macedonia, Serbia, Slovenia, Malta, Bosnia and Herzegovina, Kosovo, Montenegro, Albania, Bulgaria, Czech Republic, Estonia, Hungary, Latvia, Lithuania, Poland, Romania, Slovakia, Israel, Australia, New Zealand, Taiwan	Table B
Turkey	DS-900WN: Serial numbers starting with XDA8: Table A Serial numbers starting with XDA7: Table B
	DS-800WN: Serial numbers starting with XDA2: Table A Serial numbers starting with XD9Z: Table B

Table A

Standards	IEEE802.11b/g/n*1
Frequency Range	2400-2483.5 MHz
Maximum radio-frequency power transmitted	20 dBm (EIRP)
Channels	1/2/3/4/5/6/7/8/9/10/11/12/13
Connection Modes	Infrastructure, Wi-Fi Direct (Simple AP)*2*3
Security Protocols*4	WEP (64/128bit), WPA2-PSK (AES)*5, WPA3-SAE (AES), WPA2/WPA3-Enterprise

*1 Only available for the HT20

*2 Not supported for IEEE 802.11b

*3 Infrastructure and Wi-Fi Direct modes or an Ethernet connection can be used simultaneously.

*4 Wi-Fi Direct supports WPA2-PSK (AES) only.

*5 Complies with WPA2 standards with support for WPA/WPA2 Personal.

Table B

Standards	IEEE802.11a/b/g/n*1/ac
-----------	------------------------

Frequency Ranges	IEEE802.11b/g/n: 2.4 GHz, IEEE802.11a/n/ac: 5 GHz		
Channels	Wi-Fi	2.4 GHz	1/2/3/4/5/6/7/8/9/10/11/12* ² /13* ²
		5 GHz* ³	W52 (36/40/44/48), W53 (52/56/60/64), W56 (100/104/108/112/116/120/124/128/132/136/140/144), W58 (149/153/157/161/165)
	Wi-Fi Direct	2.4 GHz	1/2/3/4/5/6/7/8/9/10/11/12* ² /13* ²
		5 GHz* ³	W52 (36/40/44/48) W58 (149/153/157/161/165)
Connection Modes	Infrastructure, Wi-Fi Direct (Simple AP) * ⁴ * ⁵		
Security Protocols* ⁶	WEP (64/128bit), WPA2-PSK (AES)* ⁷ , WPA3-SAE (AES), WPA2/WPA3-Enterprise		

*1 Only available for the HT20

*2 Not available in Taiwan

*3 The availability of these channels and use of the product outdoors over these channels varies by location. For more information, see <http://support.epson.net/wifi5ghz/>

*4 Not supported for IEEE 802.11b

*5 Infrastructure and Wi-Fi Direct modes or an Ethernet connection can be used simultaneously.

*6 Wi-Fi Direct only supports WPA2-PSK (AES) .

*7 Complies with WPA2 standards with support for WPA/WPA2 Personal.

Ethernet Specifications

Standards	IEEE802.3i (10BASE-T)* ¹ IEEE802.3u (100BASE-TX)* ¹ IEEE802.3ab (1000BASE-T)* ¹ IEEE802.3az (Energy Efficient Ethernet)* ²
Communication Mode	Auto, 10 Mbps Full duplex, 10 Mbps Half duplex, 100 Mbps Full duplex, 100 Mbps Half duplex
Connector	RJ-45

*1 Use a category 5e or higher STP (Shielded twisted pair) cable to prevent risk of radio interference.

*2 The connected device should comply with IEEE802.3az standards.

Network Features and IPv4/IPv6 Support

Features	Supported
Epson Scan 2	IPv4, IPv6

Features	Supported
Document Capture Pro/Document Capture	IPv4
Epson Connect (Scan to Cloud)	IPv4
AirPrint	IPv4, IPv6

Security Protocol

IEEE802.1X*	
IPsec/IP Filtering	
SSL/TLS	HTTPS Server/Client
SMTPS (STARTTLS, SSL/TLS)	
SNMPv3	

* You need to use a connection device that complies with IEEE802.1X.

Supported Third Party Services

AirPrint	OS X Mavericks (10.9.5) or later
----------	----------------------------------

* We recommend using the latest Mac OS.

USB Drive Specifications

Devices	Maximum Capacities
USB Memory Device	2 TB (formatted in FAT, FAT32, or exFAT.)

You cannot use the following drives:

- A drive that requires a dedicated driver
- A drive with security settings (password, encryption, and so on)

Epson cannot guarantee all operations of externally connected drives.

Using Port for the Scanner

The scanner uses the following port. These ports should be allowed to become available by the network administrator as necessary.

When the Sender (Client) is the Scanner

Use	Destination (Server)	Protocol	Port Number
File sending (When scan to network folder is used from the scanner)	FTP/FTPS server	FTP/FTPS (TCP)	20
			21
	File server	SMB (TCP)	445
		NetBIOS (UDP)	137
		NetBIOS (TCP)	138
	WebDAV server	Protocol HTTP(TCP)	80
		Protocol HTTPS(TCP)	443
Email sending (When scan to mail is used from the scanner)	SMTP server	SMTP (TCP)	25
		SMTP SSL/TLS (TCP)	465
		SMTP STARTTLS (TCP)	587
POP before SMTP connection (When scan to mail is used from the scanner)	POP server	POP3 (TCP)	110
When Epson Connect is used	Epson Connect Server	HTTPS	443
		XMPP	5222
Collecting user information (Use the contacts from the scanner)	LDAP server	LDAP (TCP)	389
		LDAP SSL/TLS (TCP)	636
		LDAP STARTTLS (TCP)	389
User authentication when collecting user information (When using the contacts from the scanner) User authentication when using the scan to network folder (SMB) from the scanner	KDC server	Kerberos	88
Control WSD	Client computer	WSD (TCP)	5357
Search the computer when push scanning to an application	Client computer	Network Push Scan Discovery	2968

When the Sender (Client) is the Client Computer

Use	Destination (Server)	Protocol	Port Number
Discover the scanner from an application such as EpsonNet Config and scanner driver.	Scanner	ENPC (UDP)	3289
Collect and set up the MIB information from an application such as EpsonNet Config and scanner driver.	Scanner	SNMP (UDP)	161

Use	Destination (Server)	Protocol	Port Number
Searching WSD scanner	Scanner	WS-Discovery (UDP)	3702
Forwarding the scan data from an application	Scanner	Network Scan (TCP)	1865
Collecting the job information when push scanning from an application	Scanner	Network Push Scan	2968
Web Config	Scanner	HTTP(TCP)	80
		HTTPS(TCP)	443

Dimensions and Weight Specifications

Dimensions

Storage (Unit: mm (inches))

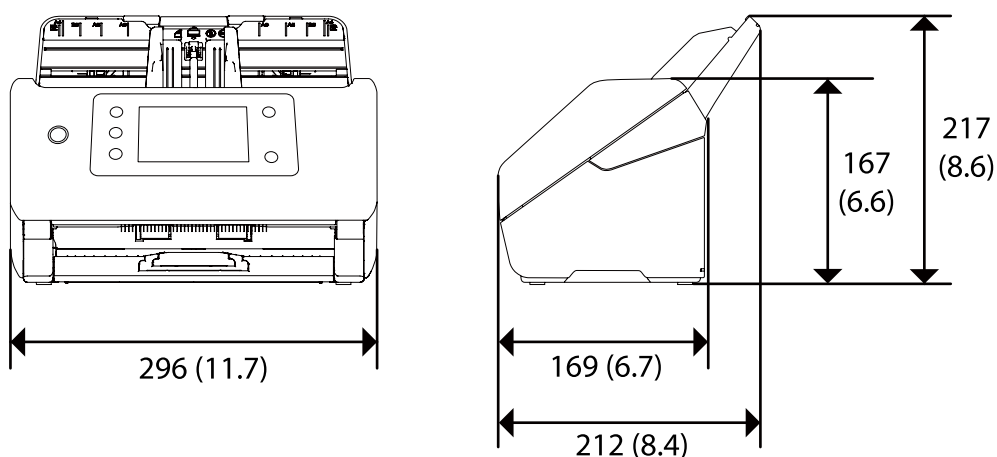

Scanning (Unit: mm (inches))

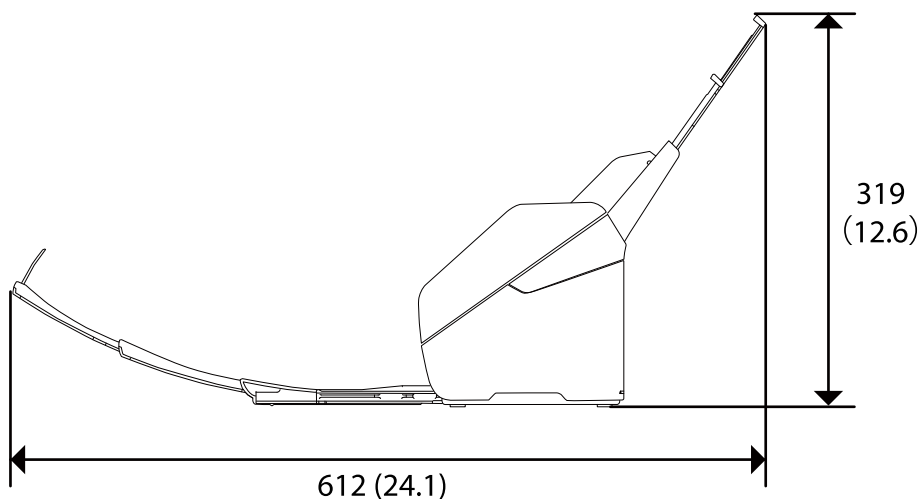

Weight

Approx. 3.7 kg (8.2 lb)

Electrical Specifications

Scanner Electrical Specifications

Rated DC Input Power Supply Voltage	DC 24 V
Rated DC Input Current	1 A

<p>Power Consumption</p>	<p>DS-900WN:</p> <p>USB Connection</p> <ul style="list-style-type: none"> <input type="checkbox"/> Operating: Approx. 19 W <input type="checkbox"/> Ready mode: Approx. 5.6 W <input type="checkbox"/> Sleep mode: Approx. 1.2 W <input type="checkbox"/> Power off: Approx.0.1 W <p>Wi-Fi Connection</p> <ul style="list-style-type: none"> <input type="checkbox"/> Operating: Approx. 19 W <input type="checkbox"/> Ready mode: Approx. 5.8 W <input type="checkbox"/> Sleep mode: Approx. 1.4 W <input type="checkbox"/> Power off: Approx.0.1 W <p>Ethernet Connection</p> <ul style="list-style-type: none"> <input type="checkbox"/> Operating: Approx. 20 W <input type="checkbox"/> Ready mode: Approx. 6.1 W <input type="checkbox"/> Sleep mode: Approx. 1.2 W <input type="checkbox"/> Power off: Approx.0.1 W
	<p>DS-800WN:</p> <p>USB Connection</p> <ul style="list-style-type: none"> <input type="checkbox"/> Operating: Approx. 18 W <input type="checkbox"/> Ready mode: Approx. 5.6 W <input type="checkbox"/> Sleep mode: Approx. 1.2 W <input type="checkbox"/> Power off: Approx.0.1 W <p>Wi-Fi Connection</p> <ul style="list-style-type: none"> <input type="checkbox"/> Operating: Approx. 19 W <input type="checkbox"/> Ready mode: Approx. 5.8 W <input type="checkbox"/> Sleep mode: Approx. 1.4 W <input type="checkbox"/> Power off: Approx.0.1 W <p>Ethernet Connection</p> <ul style="list-style-type: none"> <input type="checkbox"/> Operating: Approx. 19 W <input type="checkbox"/> Ready mode: Approx. 6.1 W <input type="checkbox"/> Sleep mode: Approx. 1.2 W <input type="checkbox"/> Power off: Approx.0.1 W

Note:

For European users, see the following Website for details on power consumption.

<http://www.epson.eu/energy-consumption>

AC Adapter Electrical Specifications

Model	A461H (AC 100-240 V) A462E (AC 220-240 V)
Rated Input Current	1 A
Rated Frequency Range	50-60 Hz
Rated Output Power Supply Voltage	DC 24 V
Rated Output Current	1 A

Note:

For European users, see the following Website for details on power consumption.

<http://www.epson.eu/energy-consumption>

Environmental Specifications

Temperature	When operating	5 to 35 °C (41 to 95 °F)
	When stored	-25 to 60 °C (-13 to 140 °F)
Humidity	When operating	15 to 80% (without condensation)
	When stored	15 to 85% (without condensation)
Operating conditions		Ordinary office or home conditions. Avoid operating the scanner in direct sunlight, near a strong light source, or in extremely dusty conditions.

System Requirements

Supported operating systems may vary depending on the application.

Windows*1	Windows 11 or later Windows 10 Windows 8/8.1 Windows 7 Windows Server 2008 or later
Mac OS*2 *3	Mac OS X 10.9 or later, macOS 11 or later

*1 Document Capture Pro does not support Windows Vista/Windows XP, and Windows Server.

*3 The UNIX File System (UFS) for Mac OS is not supported.

*2 Fast User Switching on Mac OS or later is not supported.

Standards and Approvals

Standards and Approvals for European Models.	225
Standards and Approvals for Australian Models.	225
Standards and Approvals for U.S. Models.	225
ZICTA Type Approval for Users in Zambia.	226

Standards and Approvals for European Models

Product and AC adapter

For European users

Hereby, Seiko Epson Corporation declares that the following radio equipment models are in compliance with Directive 2014/53/EU. The full text of the EU declaration of conformity is available at the following website.

<http://www.epson.eu/conformity>

J382J

A461H, A462E

For use only in Ireland, UK, Austria, Germany, Liechtenstein, Switzerland, France, Belgium, Luxembourg, Netherlands, Italy, Portugal, Spain, Denmark, Finland, Norway, Sweden, Iceland, Croatia, Cyprus, Greece, Slovenia, Malta, Bulgaria, Czech, Estonia, Hungary, Latvia, Lithuania, Poland, Romania, and Slovakia.

Epson cannot accept responsibility for any failure to satisfy the protection requirements resulting from a non-recommended modification of the product.



Standards and Approvals for Australian Models

Product

EMC	AS/NZS CISPR32 Class B
-----	------------------------

Epson hereby declares that the following equipment Models are in compliance with the essential requirements and other relevant provisions of AS/NZS4268:

J382J

Epson cannot accept responsibility for any failure to satisfy the protection requirements resulting from a non-recommended modification of the product.

AC adapter (A461H)

EMC	AS/NZS CISPR32 Class B
-----	------------------------

Standards and Approvals for U.S. Models

Product

EMC	FCC Part 15 Subpart B Class B CAN ICES-3 (B)/NMB-3 (B)
-----	---

This equipment contains the following wireless module.

Manufacturer: Seiko Epson Corporation

Type: J26H005

This product conforms to Part 15 of the FCC Rules and RSS of the IC Rules. Epson cannot accept responsibility for any failure to satisfy the protection requirements resulting from a non-recommended modification of the product. Operation is subject to the following two conditions: (1) this device may not cause harmful interference, and (2) this device must accept any interference received, including interference that may cause undesired operation of the device.

To prevent radio interference to the licensed service, this device is intended to be operated indoors and away from windows to provide maximum shielding. Equipment (or its transmit antenna) that is installed outdoors is subject to licensing.

This equipment complies with FCC/IC radiation exposure limits set forth for an uncontrolled environment and meets the FCC radio frequency (RF) Exposure Guidelines in Supplement C to OET65 and RSS of the IC radio frequency (RF) Exposure rules. This equipment should be installed and operated so that the radiator is kept at least 7.9 inches (20 cm) or more away from a person's body (excluding extremities: hands, wrists, feet and ankles).

AC adapter (A461H)

EMC	FCC Part 15 Subpart B Class B CAN ICES-3 (B)/NMB-3 (B)
-----	---

ZICTA Type Approval for Users in Zambia

See the following website to check the information for ZICTA Type Approval.

<https://support.epson.net/zicta/>

Where to Get Help

Technical Support Web Site.	228
Contacting Epson Support.	228

Technical Support Web Site

If you need further help, visit the Epson support website shown below. Select your country or region and go to the support section of your local Epson website. The latest drivers, FAQs, manuals, or other downloadables are also available from the site.

<http://support.epson.net/>

<http://www.epson.eu/support> (Europe)

If your Epson product is not operating properly and you cannot solve the problem, contact Epson support services for assistance.

Contacting Epson Support

Before Contacting Epson

If your Epson product is not operating properly and you cannot solve the problem using the troubleshooting information in your product manuals, contact Epson support services for assistance. If Epson support for your area is not listed below, contact the dealer where you purchased your product.

Epson support will be able to help you much more quickly if you give them the following information:

- Product serial number
(The serial number label is usually on the back of the product.)
- Product model
- Product software version
(Click **About**, **Version Info**, or a similar button in the product software.)
- Brand and model of your computer
- Your computer operating system name and version
- Names and versions of the software applications you normally use with your product

Note:

Depending on the product, the dial list data for fax and/or network settings may be stored in the product's memory. Due to breakdown or repair of a product, data and/or settings may be lost. Epson shall not be responsible for the loss of any data, for backing up or recovering data and/or settings even during a warranty period. We recommend that you make your own backup data or take notes.

Help for Users in Europe

Check your Pan-European Warranty Document for information on how to contact Epson support.

Help for Users in Taiwan

Contacts for information, support, and services are:

World Wide Web

<http://www.epson.com.tw>

Information on product specifications, drivers for download, and products enquiry are available.

Epson HelpDesk

Phone: +886-2-2165-3138

Our HelpDesk team can help you with the following over the phone:

- Sales enquiries and product information
- Product usage questions or problems
- Enquiries on repair service and warranty

Repair service center:

<http://www.tekcare.com.tw/branchMap.page>

TekCare corporation is an authorized service center for Epson Taiwan Technology & Trading Ltd.

Help for Users in Australia

Epson Australia wishes to provide you with a high level of customer service. In addition to your product manuals, we provide the following sources for obtaining information:

Internet URL

<http://www.epson.com.au>

Access the Epson Australia World Wide Web pages. Worth taking your modem here for the occasional surf! The site provides a download area for drivers, Epson contact points, new product information and technical support (e-mail).

Epson Helpdesk

Phone: 1300-361-054

Epson Helpdesk is provided as a final backup to make sure our clients have access to advice. Operators on the Helpdesk can aid you in installing, configuring and operating your Epson product. Our Pre-sales Helpdesk staff can provide literature on new Epson products and advise where the nearest dealer or service agent is located. Many types of queries are answered here.

We encourage you to have all the relevant information on hand when you ring. The more information you prepare, the faster we can help solve the problem. This information includes your Epson product manuals, type of computer, operating system, application programs, and any information you feel is required.

Transportation of Product

Epson recommends retaining product packaging for future transportation.

Help for Users in Singapore

Sources of information, support, and services available from Epson Singapore are:

World Wide Web

<http://www.epson.com.sg>

Information on product specifications, drivers for download, Frequently Asked Questions (FAQ), Sales Enquiries, and Technical Support via e-mail are available.

Epson HelpDesk

Toll Free: 800-120-5564

Our HelpDesk team can help you with the following over the phone:

- Sales enquiries and product information
- Product usage questions or problem troubleshooting
- Enquiries on repair service and warranty

Help for Users in Thailand

Contacts for information, support, and services are:

World Wide Web

<http://www.epson.co.th>

Information on product specifications, drivers for download, Frequently Asked Questions (FAQ), and e-mail are available.

Epson Call Centre

Phone: 66-2460-9699

Email: support@eth.epson.co.th

Our Call Centre team can help you with the following over the phone:

- Sales enquiries and product information
- Product usage questions or problems
- Enquiries on repair service and warranty

Help for Users in Vietnam

Contacts for information, support, and services are:

Epson Service Center

27 Yen Lang, Trung Liet Ward, Dong Da District, Ha Noi City. Tel: +84 24 7300 0911

38 Le Dinh Ly, Thac Gian Ward, Thanh Khe District, Da Nang. Tel: +84 23 6356 2666

194/3 Nguyen Trong Tuyen, Ward 8, Phu Nhuan Dist., HCMC. Tel: +84 28 7300 0911

31 Phan Boi Chau, Ward 14, Binh Thanh District, HCMC. Tel: +84 28 35100818

Help for Users in Indonesia

Contacts for information, support, and services are:

World Wide Web

<http://www.epson.co.id>

- Information on product specifications, drivers for download
- Frequently Asked Questions (FAQ), Sales Enquiries, questions through e-mail

Epson Hotline

Phone: 1500-766 (Indonesia Only)

Email: customer.care@ein.epson.co.id

Our Hotline team can help you with the following over the phone or email:

- Sales enquiries and product information
- Technical support

Help for Users in Malaysia

Contacts for information, support, and services are:

World Wide Web

<http://www.epson.com.my>

- Information on product specifications, drivers for download
- Frequently Asked Questions (FAQ), Sales Enquiries, questions through e-mail

Epson Call Centre

Phone: 1800-81-7349 (Toll Free)

Email: websupport@emsb.epson.com.my

- Sales enquiries and product information
- Product usage questions or problems
- Enquiries on repair services and warranty

Epson Malaysia Sdn Bhd (Head Office)

Phone: 603-56288288

Fax: 603-5628 8388/603-5621 2088

Help for Users in India

Contacts for information, support, and services are:

World Wide Web

<http://www.epson.co.in>

Information on product specifications, drivers for download, and products enquiry are available.

Toll Free Helpline

For Service, Product information or to order consumables -

18004250011 / 186030001600 / 1800123001600 (9AM – 6PM)

Email

calllog@epson-india.in

WhatsApp

+91 96400 00333

Help for Users in the Philippines

To obtain technical support as well as other after sales services, users are welcome to contact the Epson Philippines Corporation at the telephone, fax numbers and e-mail address below:

World Wide Web

<http://www.epson.com.ph>

Information on product specifications, drivers for download, Frequently Asked Questions (FAQ), and E-mail Enquiries are available.

Epson Philippines Customer Care

Toll Free: (PLDT) 1-800-1069-37766

Toll Free: (Digitel) 1-800-3-0037766

Metro Manila: +632-8441-9030

Web Site: <https://www.epson.com.ph/contact>

E-mail: customercare@epc.epson.com.ph

Accessible 9am to 6pm, Monday through Saturday (Except public holidays)

Our Customer Care team can help you with the following over the phone:

- Sales enquiries and product information
- Product usage questions or problems
- Enquiries on repair service and warranty

Epson Philippines Corporation

Trunk Line: +632-8706-2609

Fax: +632-8706-2663 / +632-8706-2665