

LSC801WU	LSC600WU
LSC800WU	LSC601WU-ST
LSC731WU	LSC600WU-ST
LSC730WU	LSC601W-ST
LSC731WU-ST	LSC600W-ST
LSC730WU-ST	LSC601-4K
LSC651WU	LSC600-4K
LSC650WU	LSC701-4K
LSC601WU	LSC700-4K

Projector User Guide

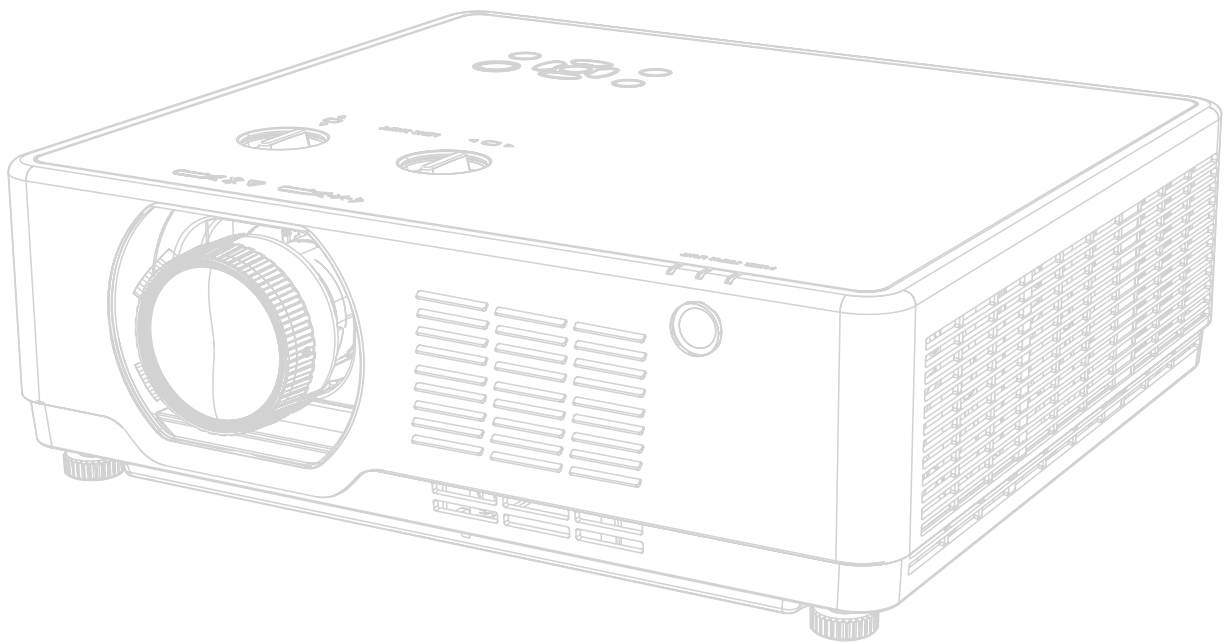

IMPORTANT: Please read this User Guide to obtain important information on installing and using your product in a safe manner, as well as registering your product for future service. Warranty information contained in this User Guide will describe your limited coverage from ViewSonic® Corporation, which is also found on our web site at <http://www.viewsonic.com> in English, or in specific languages using the Regional selection box on our website.

Model No.

VS20195 | VS20194 | VS20192 | VS20190 | VS20193 | VS20191 | VS20189 | VS20188 | VS20184 | VS20180 | VS20185 | VS20181 | VS20186 | VS20182 | VS20187 | VS20183 | VS20176 | VS20175

P/N:

LSC801WU | LSC800WU | LSC731WU | LSC730WU | LSC731WU-ST | LSC730WU-ST | LSC651WU | LSC650WU | LSC601WU | LSC600WU | LSC601WU-ST | LSC600WU-ST | LSC601W-ST | LSC600W-ST | LSC601-4K | LSC600-4K | LSC701-4K | LSC700-4K

Thank you for choosing ViewSonic®

As a world-leading provider of visual solutions, ViewSonic® is dedicated to exceeding the world's expectations for technological evolution, innovation, and simplicity. At ViewSonic®, we believe that our products have the potential to make a positive impact in the world, and we are confident that the ViewSonic® product you have chosen will serve you well.

Once again, thank you for choosing ViewSonic®!

Safety Precautions

Please read the following **Safety Precautions** before you start using the projector.

- Keep this user guide in a safe place for later reference.
- Read all warnings and follow all instructions.
- Allow at least 20" (50 cm) clearance around the projector to ensure proper ventilation.
- Place the projector in a well-ventilated area. Do not place anything on the projector that prevents heat dissipation.
- Do not place the projector on an uneven or unstable surface. The projector may fall over, causing personal injury or projector malfunction.
- Do not look straight at the projector lens during operation. The intense light beam may damage your eyes.
- Always open the lens shutter or remove the lens cap when the projector lamp is on.
- Do not block the projection lens with any objects when the projector is under operation as this could cause objects to become heated and deformed or even cause a fire.
- The lamp becomes extremely hot during operation. Allow the projector to cool for approximately 45 minutes prior to removing the lamp assembly for replacement.
- Do not use lamps beyond the rated lamp life. Excessive use of lamps beyond the rated life could cause them to break on rare occasions.
- Never replace the lamp assembly or any electronic component unless the projector is unplugged.
- Do not attempt to disassemble the projector. There are dangerous high voltages inside which may cause death if you should come into contact with live parts.
- When moving the projector, be careful not to drop or bump the projector on anything.
- Do not place any heavy objects on the projector or connection cables.
- Do not stand the projector on end vertically. Doing so may cause the projector to fall over, causing personal injury or projector malfunction.
- Avoid exposing the projector to direct sunlight or other sources of sustained heat. Do not install near any heat sources such as radiators, heat registers, stoves, or other devices (including amplifiers) that may increase the temperature of the projector to dangerous levels.
- Do not place liquids near or on the projector. Liquids spilled into the projector may cause it to fail. If the projector does become wet, disconnect it from the power supply and call your local service center to have the projector serviced.

- When the projector is under operation, you may sense some heated air and odor from its ventilation grill. It is a normal operation and not a defect.
- Do not attempt to circumvent the safety provisions of the polarized or grounding-type plug. A polarized plug has two blades with one wider than the other. A grounding-type plug has two blades and a third grounding prong. The wide and third blade are provided for your safety. If the plug does not fit into your outlet, obtain an adapter and do not attempt to force the plug into the outlet.
- When connecting to a power outlet, DO NOT remove the grounding prong. Please ensure grounding prongs are NEVER REMOVED.
- Protect the power cord from being treaded upon or pinched, particularly at the plug, and at the point where it emerges from the projector.
- In some countries, the voltage is NOT stable. This projector is designed to operate safely within a voltage between 100 to 240 volts AC, but could fail if power cuts or surges of ± 10 volts occur. In areas where voltage may fluctuate or cut out, it is recommended that you connect your projector through a power stabilizer, surge protector, or uninterruptable power supply (UPS).
- If smoke, an abnormal noise, or a strange odor is present, immediately switch the projector off and call your dealer or ViewSonic®. It is dangerous to continue using the projector.
- Use only attachments/accessories specified by the manufacturer.
- Disconnect the power cord from the AC outlet if the projector is not being used for a long period of time.
- Refer all servicing to qualified service personnel.

CAUTION: Possibly hazardous optical radiation is emitted from this product. As with any bright light source, do not stare into the beam.

CLASS 1 Consumer Laser Product EN50689:2021

- Notice is given to supervise children and to never allow them to stare into the projector beam at any distance from the projector.
- Notice is given to use caution when using the remote control for starting the projector while in front of the projection lens.
- Notice is given to the user to avoid the use of optical aids such as binoculars or telescopes inside the beam.



RG2 IEC 62471-5:2015.

Additional warning against eye exposure for close exposures less than 1 m.

Safety Precautions - Ceiling Mounting

Please read the following **Safety Precautions** before you start using the projector.

If you intend to mount the projector on the ceiling, it is strongly recommended that you use a proper fitting projector ceiling mount kit and that you ensure it is securely and safely installed.

If you use an inappropriate projector ceiling mount kit, there is a safety risk that the projector may fall from the ceiling due to an improper attachment through the use of the wrong gauge or length screws.

Contents

Safety Precautions.....	3
Introduction	9
Package Contents	9
LSC600W-ST LSC601W-ST LSC600WU-ST LSC601WU-ST	9
LSC730WU-ST LSC731WU-ST.....	10
LSC600WU LSC601WU.....	11
LSC650WU LSC651WU LSC730WU LSC731WU LSC800WU LSC801WU ..	12
LSC600-4K LSC601-4K LSC700-4K LSC701-4K	13
Product Overview	14
Projector.....	14
Keypad.....	19
I/O Ports	21
Remote Control.....	23
Initial Setup.....	29
Choosing a Location - Projection Orientation.....	29
Projection Dimensions.....	30
LSC600WU LSC601WU.....	30
LSC650WU LSC651WU LSC730WU LSC731WU LSC800WU LSC801WU ...	32
LSC600W-ST LSC601W-ST LSC600WU-ST LSC601WU-ST	34
LSC730WU-ST LSC731WU-ST.....	36
LSC600-4K LSC601-4K LSC700-4K LSC701-4K	38
Mounting the Projector	40
Using the Security Bar	40
Making Connections	41
Connecting to Power	41
Connecting to External Devices	42
VGA Connection	42
VGA Out Connection	43
HDMI Connection	44
Audio Connection.....	45
USB Connection.....	47
Network Connection	49
RS-232 Connection	50
HDBaseT Connection.....	51

Using the Projector.....	52
Turning the Projector On.....	52
Selecting an Input Source	53
Adjusting the Projected Image	55
Adjusting the Projector’s Height and Projection Angle.....	55
Fine-Tuning the Image Size and Clarity	56
Controlling the Projected Image Position (Lens Shift).....	57
Turning the Projector Off	64
Menu Operation (non 4K models)	65
On-Screen Display (OSD) Menu	65
Menu Navigation	66
On-Screen Display (OSD) Menu Tree.....	67
Menu Options.....	76
Display	76
Image Settings.....	78
Settings.....	80
Advanced.....	84
USB-A	89
Information	91
Menu Operation (4K models)	92
On-Screen Display (OSD) Menu	92
Menu Navigation	93
On-Screen Display (OSD) Menu Tree.....	94
Menu Options.....	99
Adjust	99
Installation.....	102
Settings.....	103

Appendix.....	106
Specifications.....	106
Projector Dimensions	110
LSC600WU LSC601WU LSC650WU LSC651WU LSC730WU LSC731WU	
LSC800WU LSC801WU LSC600-4K LSC601-4K LSC700-4K LSC701-4K ...	110
LSC600W-ST LSC601W-ST LSC600WU-ST LSC601WU-ST	110
LSC730WU-ST LSC731WU-ST.....	111
Timing Chart	112
HDMI Signal	113
HDMI Signal.....	115
LSC600-4K LSC601-4K LSC700-4K LSC701-4K.....	115
Troubleshooting	116
LED Indicators.....	118
Maintenance.....	119
General Precautions.....	119
Cleaning the Lens	119
Cleaning the Case	119
Storing the Projector	119
Cleaning the Filter	120
Regulatory and Service Information	121
Compliance Information.....	121
FCC Compliance Statement.....	121
Industry Canada Statement.....	121
CE Conformity for European Countries	122
Declaration of RoHS2 Compliance.....	123
Indian Restriction of Hazardous Substances	124
Product Disposal at End of Product Life	124
Copyright Information	125
Customer Service	126
Limited Warranty	127
Mexico Limited Warranty.....	130

Introduction

Package Contents

LSC600W-ST | LSC601W-ST | LSC600WU-ST | LSC601WU-ST

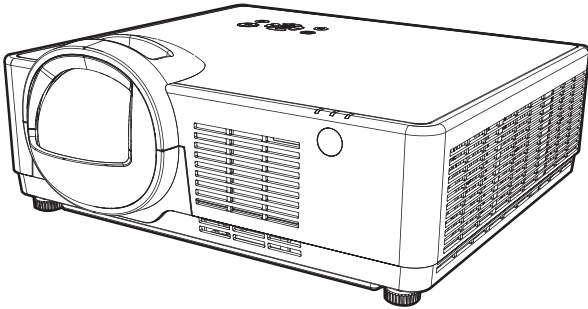

①



②



③



④



⑤

Number	Description
1	Projector
2	Remote Control
3	Batteries
4	Quick Start Guide
5	Power Cord

NOTE: The power cord and remote control included in your package may vary depending on your country. Please contact your local reseller for more information.

LSC730WU-ST | LSC731WU-ST

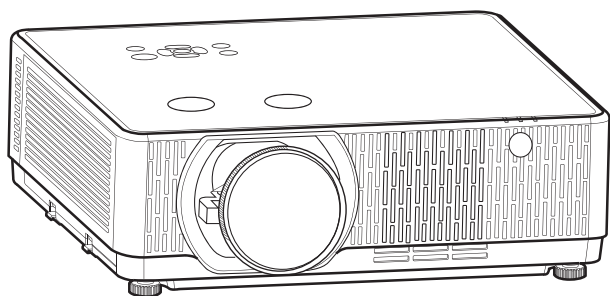

①



②



③



④

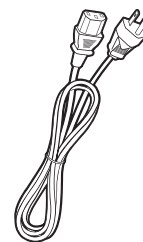

⑤

Number	Description
1	Projector
2	Remote Control
3	Batteries
4	Quick Start Guide
5	Power Cord

NOTE: The power cord and remote control included in your package may vary depending on your country. Please contact your local reseller for more information.

LSC600WU | LSC601WU

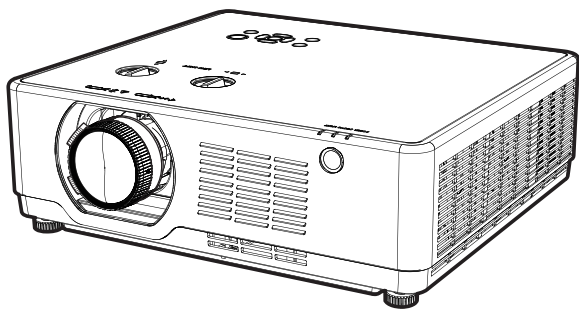

①



②



③



④

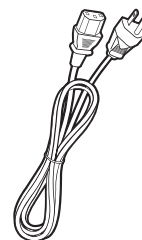

⑤

Number	Description
1	Projector
2	Remote Control
3	Batteries
4	Quick Start Guide
5	Power Cord

NOTE: The power cord and remote control included in your package may vary depending on your country. Please contact your local reseller for more information.

LSC650WU | LSC651WU | LSC730WU | LSC731WU | LSC800WU | LSC801WU

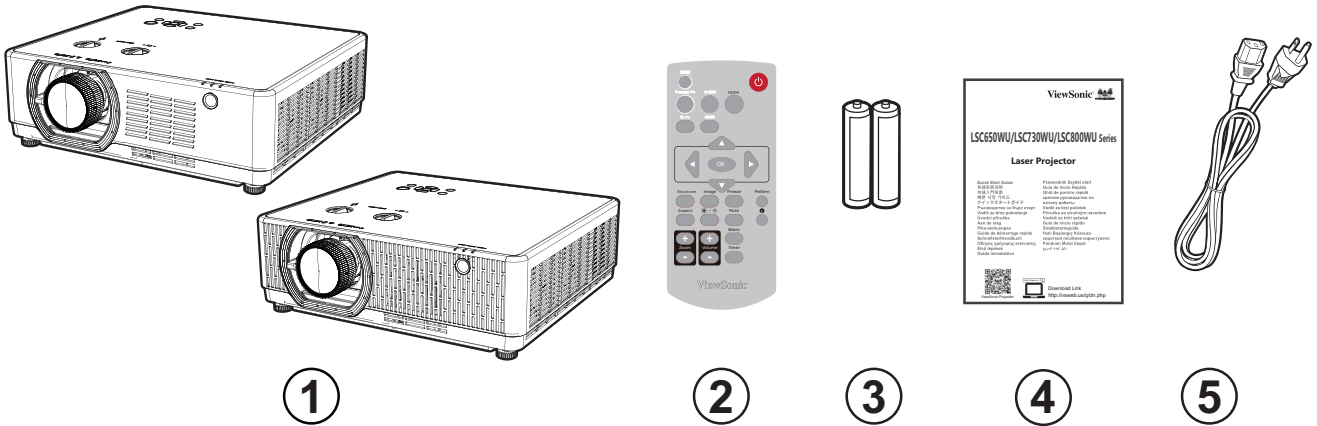

Number	Description
1	Projector
2	Remote Control
3	Batteries
4	Quick Start Guide
5	Power Cord

NOTE: The power cord and remote control included in your package may vary depending on your country. Please contact your local reseller for more information.

LSC600-4K | LSC601-4K | LSC700-4K | LSC701-4K

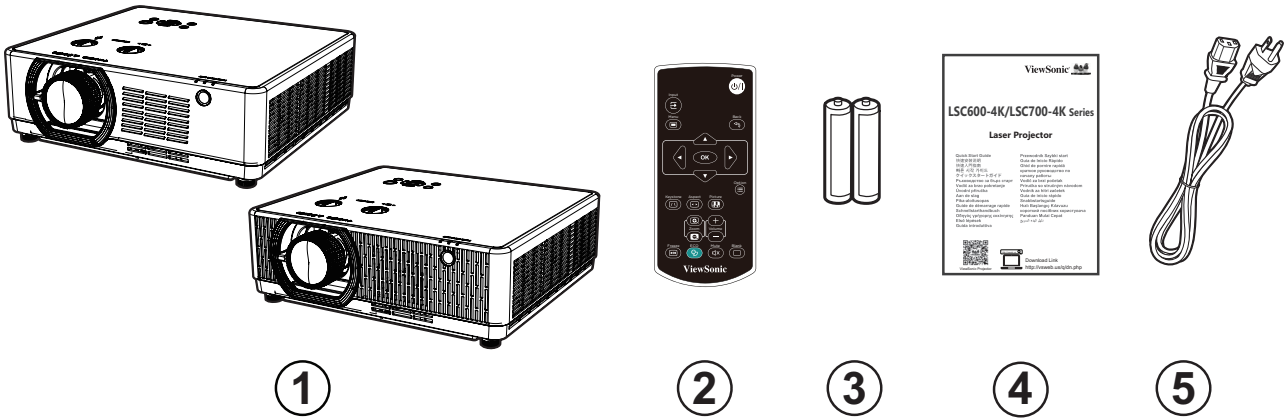

Number	Description
1	Projector
2	Remote Control
3	Batteries
4	Quick Start Guide
5	Power Cord

NOTE: The power cord and remote control included in your package may vary depending on your country. Please contact your local reseller for more information.

Product Overview

Projector

LSC600W-ST | LSC601W-ST | LSC600WU-ST | LSC601WU-ST

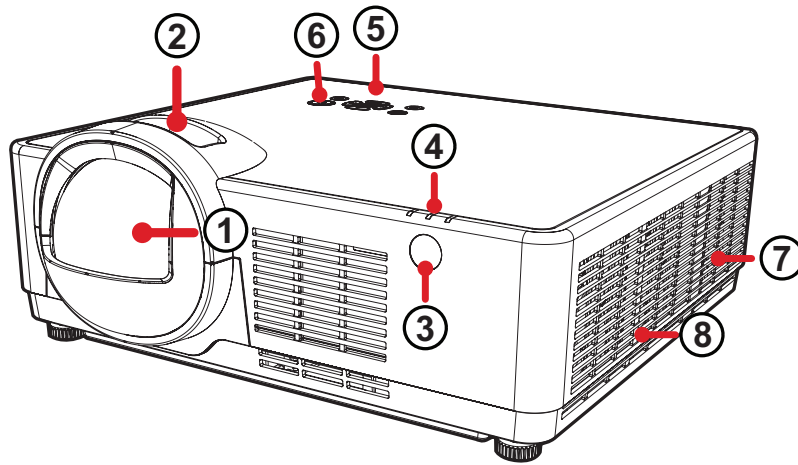

Number	Description
1	Projection Lens
2	Focus Ring
3	Remote Control IR Sensor
4	LED Indicator
5	Keypad
6	Power Button
7	Vent
8	Filter

NOTE: Do not block projector intake and exhaust vents.

LSC730WU-ST | LSC731WU-ST

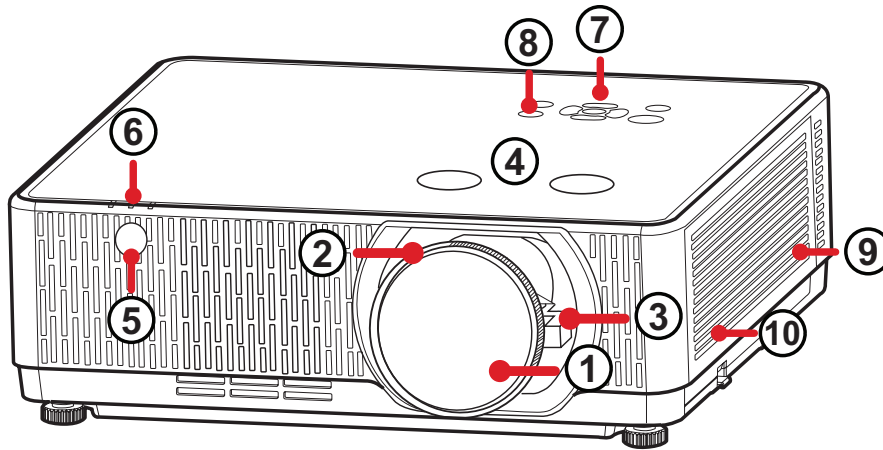

Number	Description
1	Projection Lens
2	Focus Ring
3	Zoom Ring
4	Lens Shift (H & V)
5	Remote Control IR Sensor
6	LED Indicator
7	Keypad
8	Power Button
9	Vent
10	Filter

NOTE: Do not block projector intake and exhaust vents.

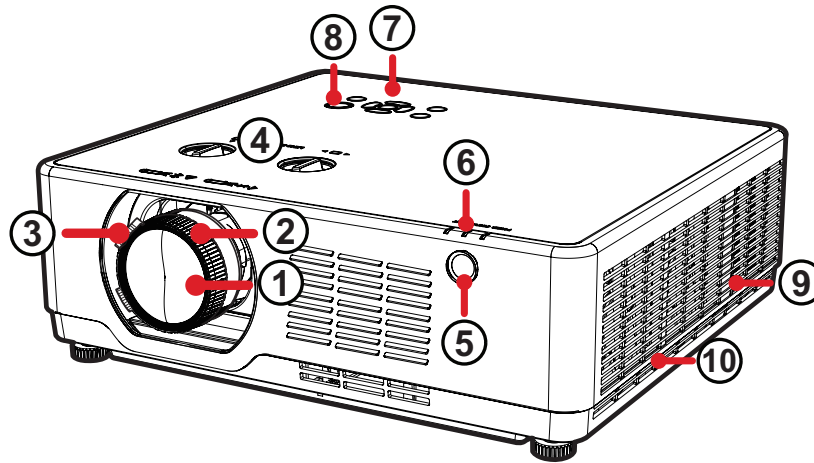

Number	Description
1	Projection Lens
2	Focus Ring
3	Zoom Ring
4	Lens Shift (H & V)
5	Remote Control IR Sensor
6	LED Indicator
7	Keypad
8	Power Button
9	Vent
10	Filter

NOTE:

- Do not block projector intake and exhaust vents.
- Remove the foam protector from the lens before turning on the projector to prevent it from interfering with the cooling system and heat flow.

LSC650WU | LSC651WU | LSC730WU | LSC731WU | LSC800WU | LSC801WU

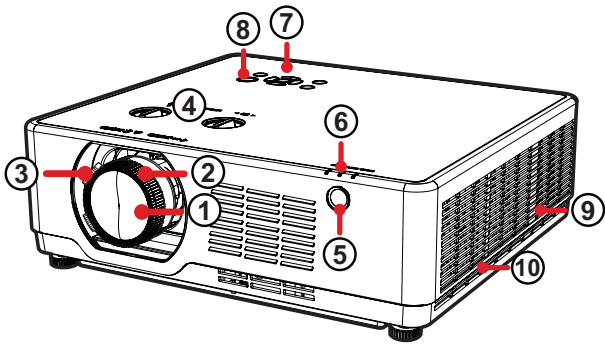

LSC650WU
LSC651WU

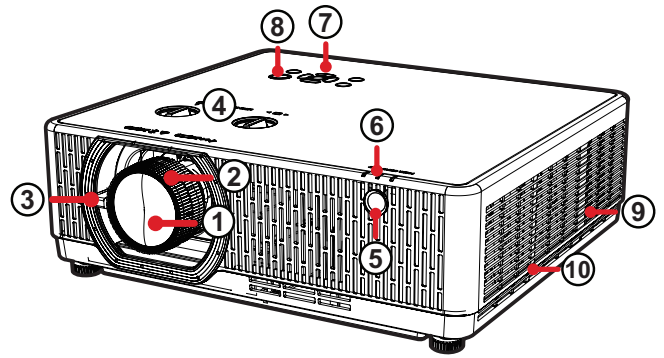

LSC730WU LSC800WU
LSC731WU LSC801WU

Number	Description
1	Projection Lens
2	Focus Ring
3	Zoom Ring
4	Lens Shift (H & V)
5	Remote Control IR Sensor
6	LED Indicator
7	Keypad
8	Power Button
9	Vent
10	Filter

NOTE:

- Do not block projector intake and exhaust vents.
- Remove the foam protector from the lens before turning on the projector to prevent it from interfering with the cooling system and heat flow.

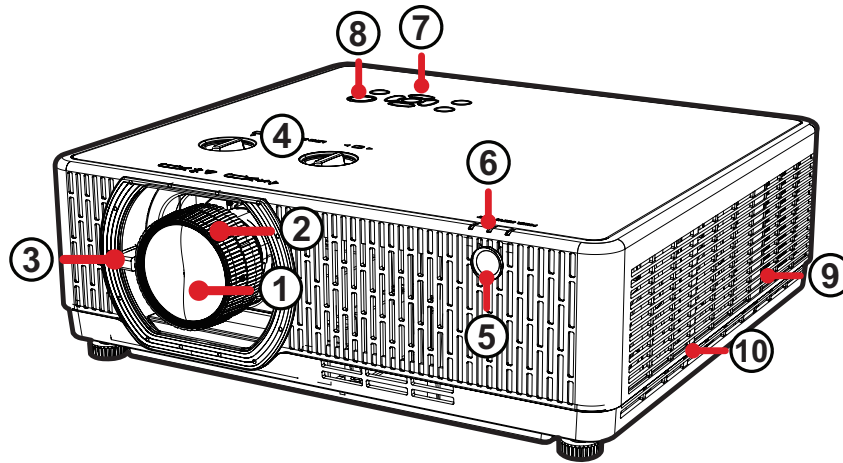

Number	Description
1	Projection Lens
2	Focus Ring
3	Zoom Ring
4	Lens Shift (H & V)
5	Remote Control IR Sensor
6	LED Indicator
7	Keypad
8	Power Button
9	Vent
10	Filter

NOTE:

- Do not block projector intake and exhaust vents.
- Remove the foam protector from the lens before turning on the projector to prevent it from interfering with the cooling system and heat flow.

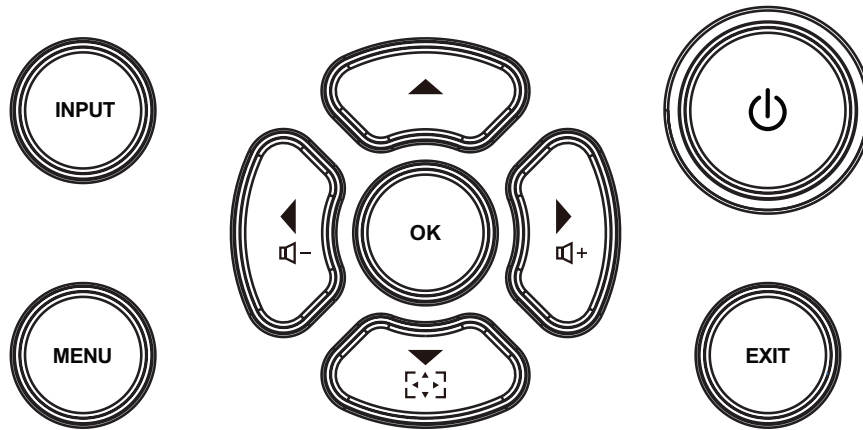

Keypad

LSC600W-ST | LSC601W-ST | LSC600WU-ST | LSC601WU-ST | LSC730WU-ST |
 LSC731WU-ST | LSC600WU | LSC601WU | LSC650WU | LSC651WU | LSC730WU |
 LSC731WU | LSC800WU | LSC801WU

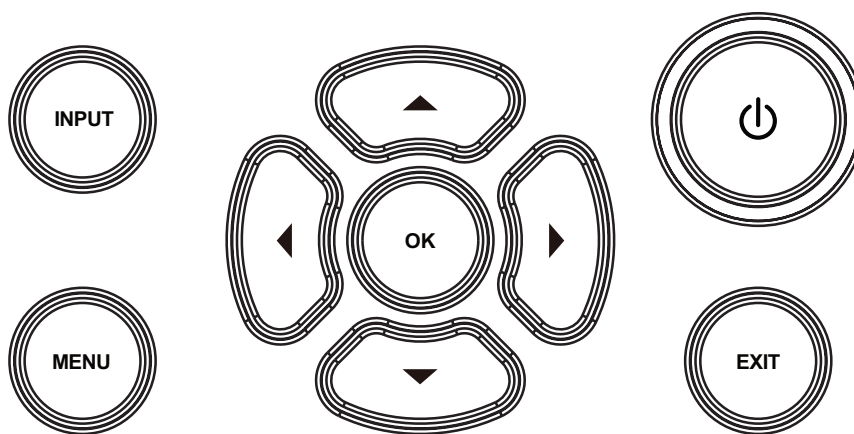

Key		Description
INPUT	Input	Displays the input source selection bar.
MENU	Menu	Open the On-Screen Display (OSD) Menu.
	Power	Toggles the projector between standby mode and Power On.
EXIT	Exit	Close the On-Screen Display (OSD) Menu.
	Navigation	Selects the desired menu items and makes adjustments when the On-Screen Display (OSD) Menu is activated.
	Volume	Adjust the sound level.
	Keystone	Opens the Keystone menu to correct distorted images resulting from an angled projection.
OK	OK	Confirms the selection.



Key		Description
INPUT	Input	Displays the input source selection bar.
MENU	Menu	Open the On-Screen Display (OSD) Menu.
	Power	Toggles the projector between standby mode and Power On.
EXIT	Exit	Close the On-Screen Display (OSD) Menu.
	Navigation	Selects the desired menu items and makes adjustments when the On-Screen Display (OSD) Menu is activated.
OK	OK	Confirms the selection.

I/O Ports

LSC600W-ST | LSC601W-ST | LSC600WU-ST | LSC601WU-ST | LSC730WU-ST |
 LSC731WU-ST | LSC600WU | LSC601WU | LSC650WU | LSC651WU | LSC730WU |
 LSC731WU | LSC800WU | LSC801WU

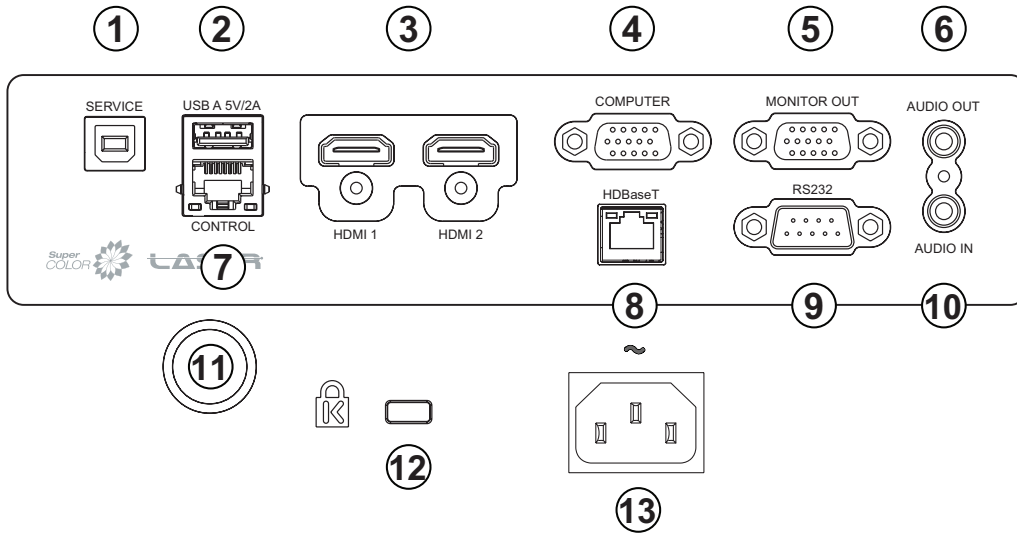

Port	Description
1	SERVICE USB Type B port for service and USB display.
2	USB A 5V/2A USB Type A port for reader (USB 2.0, FAT32) and power.
3	HDMI 1 / HDMI 2 HDMI port.
4	COMPUTER RGB (PC) signal input port.
5	MONITOR OUT RGB (PC) signal output port.
6	AUDIO OUT Audio signal output port.
7	CONTROL LAN control port.
8	HDBaseT¹ HDBaseT port.
9	RS-232 RS-232 control port.
10	AUDIO IN Audio signal input port.
11	Remote Control IR Sensor IR Sensor.
12	Security Slot Security slot for securing the projector to a fixed object.
13	AC IN AC IN socket.

1 - HDBaseT is only for LSC601W-ST, LSC601WU-ST, LSC731WU-ST, LSC601WU, LSC651WU, LSC731WU, and LSC801WU only.

LSC600-4K | LSC601-4K | LSC700-4K | LSC701-4K

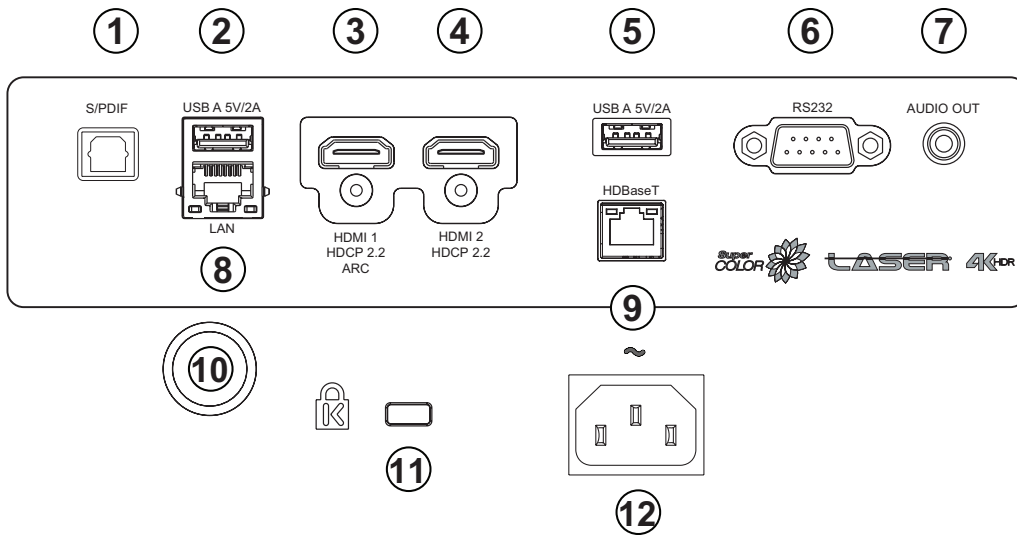



Port		Description
1	S/DPDIF	Multichannel sound via optical signals.
2	USB A 5V/2A	USB Type A port for reader (USB 2.0, FAT32) and power.
3	HDMI 1	HDMI port. Supports HDCP 2.2 and ARC.
4	HDMI 2	HDMI port. Supports HDCP 2.2.
5	USB A 5V/2A	USB Type A port for reader (USB 2.0, FAT32) and power.
6	RS-232	RS-232 control port.
7	AUDIO OUT	Audio signal output port.
8	LAN	LAN control port.
9	HDBaseT ²	HDBaseT port.
10	Remote Control IR Sensor	IR Sensor.
11	Security Slot	Security slot for securing the projector to a fixed object.
12	AC IN	AC IN socket.

²-HDBaseT is only for LSC601-4K and LSC701-4K only.

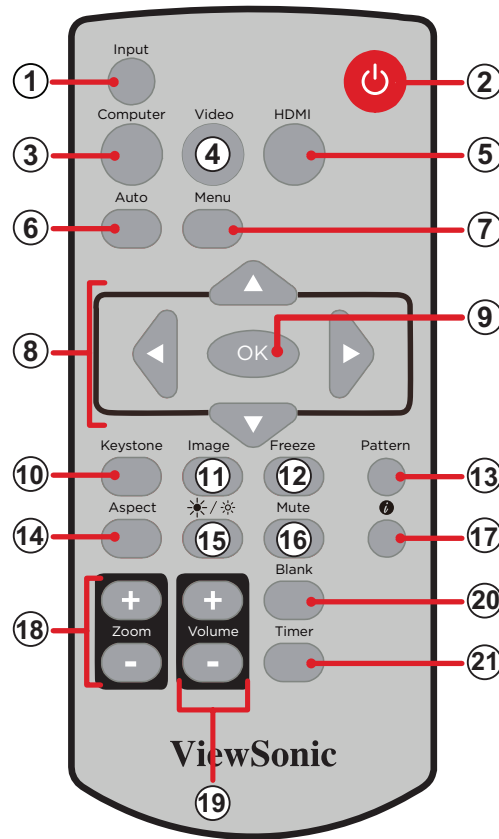

Remote Control

LSC600W-ST | LSC601W-ST | LSC600WU-ST | LSC601WU-ST | LSC730WU-ST |
 LSC731W-ST | LSC600WU | LSC601WU | LSC650WU | LSC651WU | LSC730WU |
 LSC731WU | LSC800WU | LSC801WU









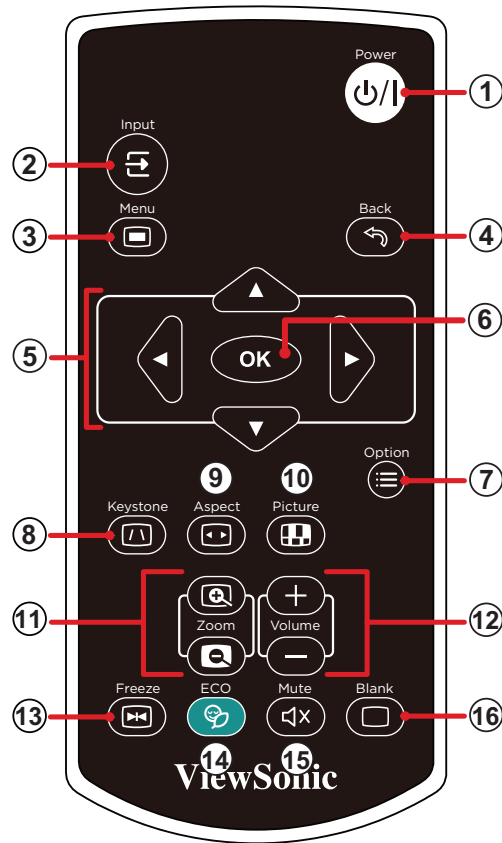

Button		Description
1	Input	Displays the source selection bar.
2		Turn the projector on or off.
3	Computer	Selects the VGA input source.
4	Video	<i>This button is not supported.</i>
5	HDMI	Selects the HDMI 1 or HDMI 2 input source.
6	Auto³	Enter auto adjustment mode.
7	Menu	Open the On-Screen Display (OSD) Menu.
8		Navigates and selects the desired menu items and make adjustments.

³ - For Computer input source only.

Button		Description
9	OK	Confirm the selection.
10	Keystone	Opens the Keystone menu to correct distorted images resulting from an angled projection.
11	Image	Selects the image mode.
12	Freeze	Freeze the projected image.
13	Pattern	Displays embedded test pattern.
14	Aspect	Displays the aspect ratio selection bar.
15	 / 	Selects Light source mode.
16	Mute	Turn on or off the sound.
17		Display the current status and information of the projector.
18	Zoom	Increase or decrease the projected image size.
19	Volume	Increase or decrease the sound level.
20	Blank	Temporarily hides the projected image.
21	Timer	Enable the timer function.



Button		Description	
1		Power	Turn the projector on or off.
2		Input	Displays the source selection bar.
3		Menu	Open the On-Screen Display (OSD) Menu.
4		Back	Returns to the previous screen.
5		Navigational Buttons	Navigates and selects the desired menu items and make adjustments.
6	OK	OK	Confirm the selection.
7		Option	Edit files or set the way files are displayed/arranged when using the USB input channel.
8		Keystone	Opens the Keystone menu to correct distorted images resulting from an angled projection.
9		Aspect	Displays the aspect ratio selection bar.

Button		Description
10		Picture Selects the picture mode.
11	 	Zoom Increase or decrease the projected image size.
12	 	Volume Increase or decrease the sound level.
13		Freeze Freeze the projected image.
14		ECO Selects the Light source mode.
15		Mute Turn on or off the sound.
16		Blank Temporarily hides the projected image.

Receiver Range

To ensure proper function of the remote control follow the steps below:

1. The remote control must be held at an angle within 30° perpendicular to the projector's IR remote control sensor(s).
2. The distance between the remote control and the sensor(s) should not exceed 6 m (19 ft).

NOTE: Refer to the illustration for the location of the infrared (IR) remote control sensor(s).

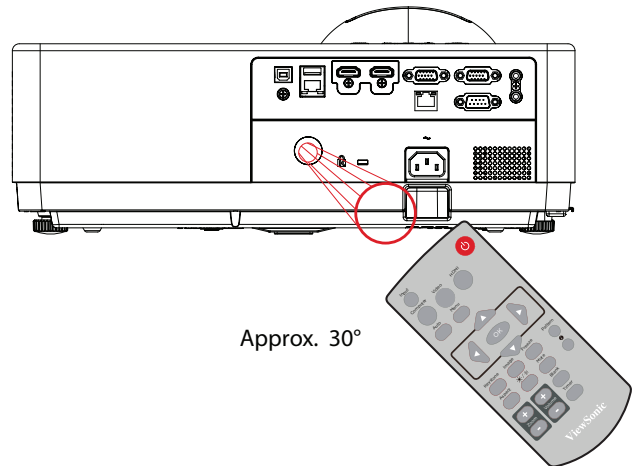
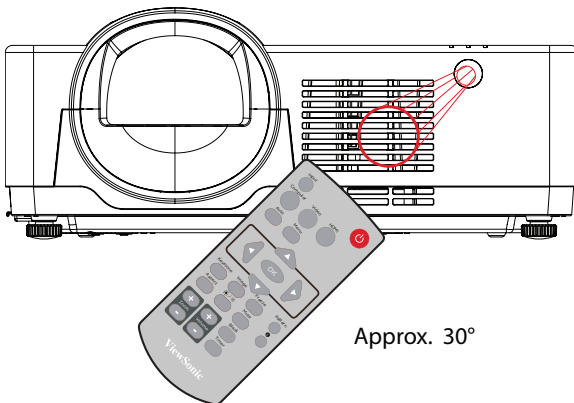

Replacing the Batteries

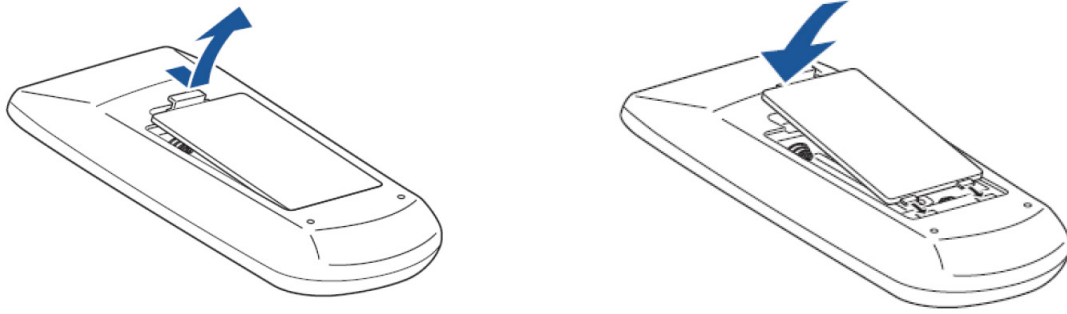

1. Remove the battery cover from the bottom of the remote control.
2. Remove any existing batteries (if necessary) and install two AAA batteries.
NOTE: Observe the battery's polarities as indicated.
3. Replace the battery cover by aligning it with the base and pushing it back into position.

NOTE:

- Avoid leaving the remote control and batteries in excessive heat or a humid environment.
- Replace only with the same or equivalent type recommended by the battery manufacturer.
- If the batteries are drained or if you will not be using the remote control for an extended period of time, remove the batteries to avoid damage to the remote control.
- Dispose of the used batteries according to the manufacturer's instructions and local environment regulations for your region.

Initial Setup

Choosing a Location - Projection Orientation

Personal preference and room layout will decide the installation location. Consider the following:

- Size and position of your screen.
- Location of a suitable power outlet.
- Location and distance between the projector and other equipment.

The projector is designed to be installed in one of the following locations:

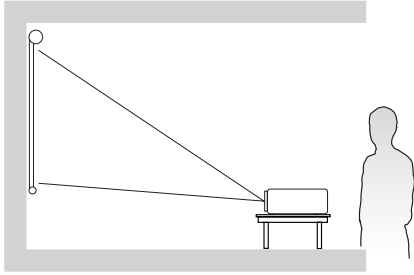
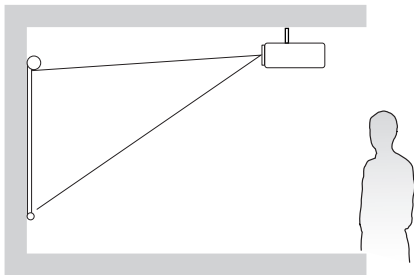
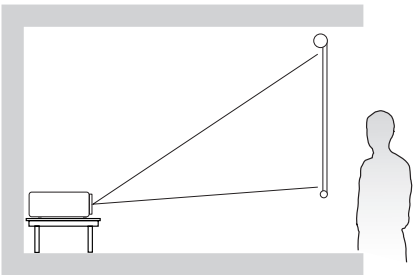
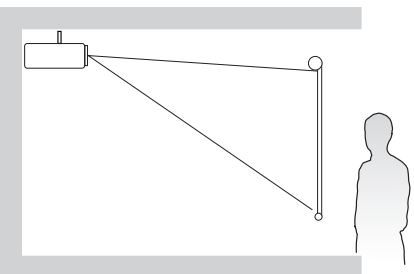
Location	
<p>Front</p> <p>The projector is placed near the floor in front of the screen.</p>	
<p>Ceiling Front</p> <p>The projector is suspended upside-down from the ceiling in front of the screen.</p>	
<p>Rear¹</p> <p>The projector is placed near the floor behind the screen.</p>	
<p>Ceiling Rear¹</p> <p>The projector is suspended upside-down from the ceiling behind the screen.</p>	

NOTE: When selecting **Auto Ceiling/Front** or **Auto Ceiling/Rear** as the projector position, the projector will be considered front projection automatically.

¹ A rear projection screen is required.

Projection Dimensions

LSC600WU | LSC601WU

16:10 Image on a 16:10 Screen

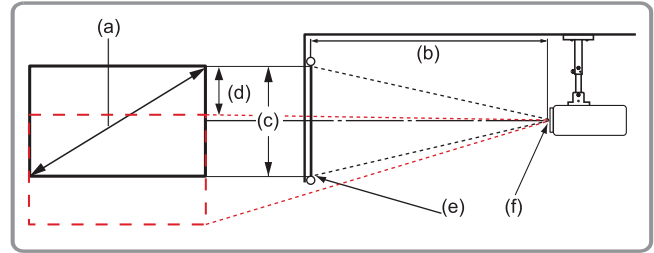
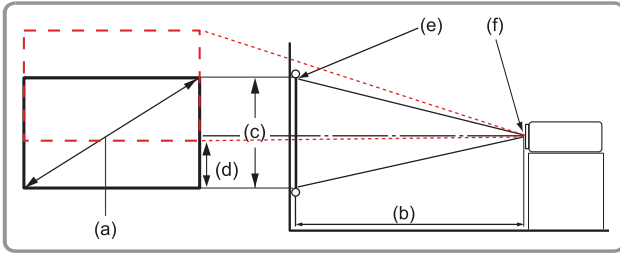

NOTE: (e) = Screen / (f) = Center of Lens

(a) Screen Size		(b) Projection Distance				(c) Image Height		(d) Vertical Offset	
		Minimum		Maximum					
in.	mm	in.	mm	in.	mm	in.	mm	in.	mm
30	762	26.76	680	44.15	1121	15.90	404	7.15	182
60	1524	54.68	1389	89.43	2272	31.80	808	14.31	363
70	1778	63.98	1625	104.53	2655	37.10	942	16.69	424
80	2032	73.28	1861	119.62	3038	42.40	1077	19.08	485
90	2286	82.59	2098	134.72	3422	47.70	1212	21.46	545
100	2540	91.89	2334	149.82	3805	53.00	1346	23.85	606
120	3048	110.50	2807	180.01	4572	63.60	1615	28.62	727
150	3810	138.41	3516	225.29	5722	79.50	2019	35.77	909
180	4572	166.33	4225	270.58	6873	95.40	2423	42.93	1090
200	5080	184.94	4697	300.77	7640	106.00	2692	47.70	1212
250	6350	231.46	5879	376.25	9557	132.50	3365	59.62	1514
300	7620	277.98	7061	451.73	11474	159.00	4039	71.55	1817

NOTE:

- These figures are for reference purposes only. Please refer to the actual projector for the precise dimensions.
- It is recommended that if you intend to permanently install the projector to physically test the projection size and distance using the actual projector before you permanently install it.

16:10 Image on a 4:3 Screen

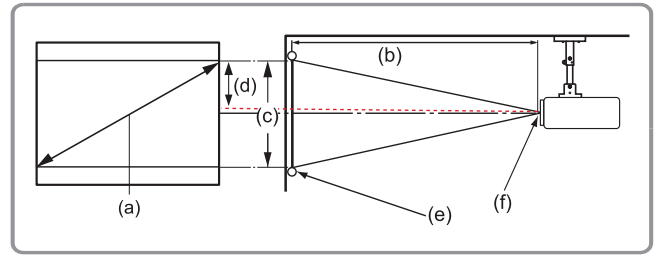
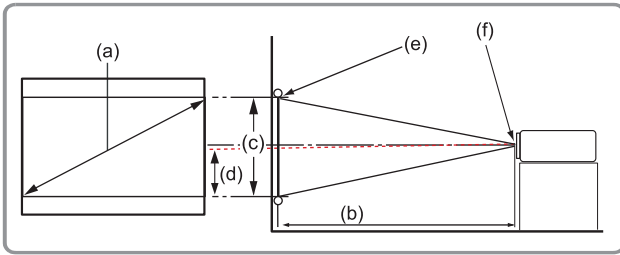

NOTE: (e) = Screen / (f) = Center of Lens

(a) Screen Size		(b) Projection Distance				(c) Image Height		(d) Vertical Offset	
		Minimum		Maximum					
in.	mm	in.	mm	in.	mm	in.	mm	in.	mm
30	762	25.91	658	42.24	1073	15.00	381	6.73	171
60	1524	51.73	1314	84.33	2142	29.96	761	13.48	342
70	1778	60.43	1535	98.50	2502	34.96	888	15.73	400
80	2032	69.11	1755	112.64	2861	39.98	1015	17.99	457
90	2286	77.74	1975	126.72	3219	44.98	1142	20.24	514
100	2540	86.38	2194	140.80	3576	49.97	1269	22.49	571
120	3048	103.66	2633	168.96	4292	59.97	1523	26.99	685
150	3810	129.57	3291	211.20	5364	74.96	1904	33.73	857
180	4572	155.49	3949	253.44	6437	89.95	2285	40.48	1028
200	5080	172.76	4388	281.60	7153	99.94	2539	44.98	1142
250	6350	215.96	5485	352.00	8941	124.93	3173	56.22	1428
300	7620	259.15	6582	422.40	10729	149.92	3808	67.46	1714

NOTE:

- These figures are for reference purposes only. Please refer to the actual projector for the precise dimensions.
- It is recommended that if you intend to permanently install the projector to physically test the projection size and distance using the actual projector before you permanently install it.

LSC650WU | LSC651WU | LSC730WU | LSC731WU | LSC800WU | LSC801WU

16:10 Image on a 16:10 Screen

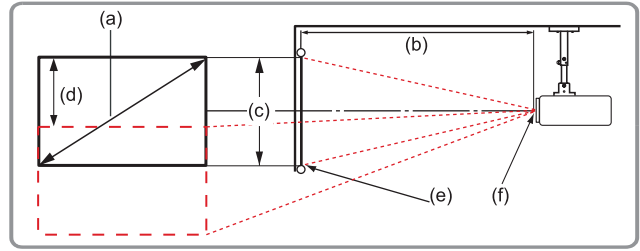
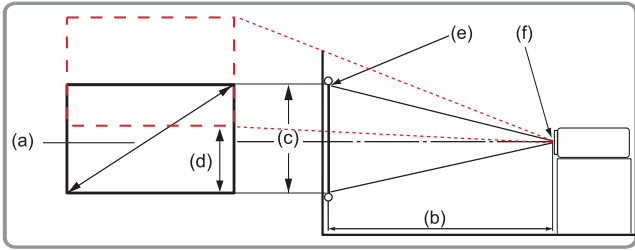

NOTE: (e) = Screen / (f) = Center of Lens

(a) Screen Size		(b) Projection Distance				(c) Image Height		(d) Vertical Offset	
		Minimum		Maximum					
in.	mm	in.	mm	in.	mm	in.	mm	in.	mm
30	762	30.10	765	49.54	1258	16	404	9.54	242
60	1524	61.59	1564	100.40	2550	32	808	19.08	485
70	1778	72.09	1831	117.35	2981	37	942	22.26	565
80	2032	82.59	2098	134.31	3411	42	1077	25.44	646
90	2286	93.09	2364	151.26	3842	48	1212	28.62	646
100	2540	103.58	2631	168.21	4273	53	1346	31.80	808
120	3048	124.58	3164	202.12	5134	64	1615	38.16	969
150	3810	156.07	3964	252.98	6426	79	2019	47.70	1212
180	4572	187.56	4764	303.85	7718	95	2423	57.24	1454
200	5080	208.56	5297	337.75	8579	106	2692	63.60	1615
250	6350	261.05	6631	422.52	10732	132	3365	79.50	2019
300	7620	314	7964	507.29	12885	159	4039	95.40	2423

NOTE:

- These figures are for reference purposes only. Please refer to the actual projector for the precise dimensions.
- It is recommended that if you intend to permanently install the projector to physically test the projection size and distance using the actual projector before you permanently install it.

16:10 Image on a 4:3 Screen

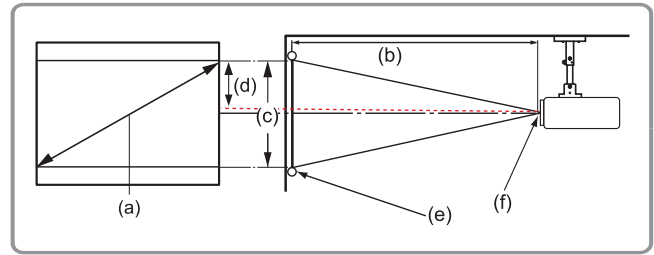
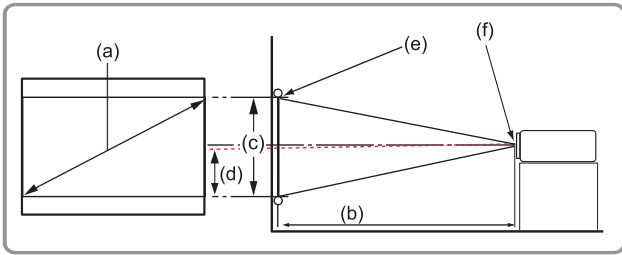

NOTE: (e) = Screen / (f) = Center of Lens

(a) Screen Size		(b) Projection Distance				(c) Image Height		(d) Vertical Offset	
		Minimum		Maximum					
in.	mm	in.	mm	in.	mm	in.	mm	in.	mm
30	762	28.82	732	48.23	1225	15.00	381	9.00	229
60	1524	57.60	1463	96.50	2451	30.00	762	18.00	457
70	1778	67.20	1707	112.56	2859	35.00	889	21.00	533
80	2032	76.81	1951	128.62	3267	40.00	1016	24.00	610
90	2286	86.41	2195	144.70	3675	45.00	1143	27.00	686
100	2540	96.01	2439	160.78	4084	50.00	1270	30.00	762
120	3048	115.22	2926	192.93	4900	60.00	1524	36.00	914
150	3810	144.02	3658	241.17	6126	75.00	1905	45.00	1143
180	4572	172.82	4390	289.40	7351	90.00	2286	54.00	1372
200	5080	192.03	4877	321.55	8167	100.00	2540	60.00	1524
250	6350	240.03	6097	401.94	10209	125.00	3175	75.00	1905
300	7620	288.04	7316	482.33	12251	150.00	3810	90.00	2286

NOTE:

- These figures are for reference purposes only. Please refer to the actual projector for the precise dimensions.
- It is recommended that if you intend to permanently install the projector to physically test the projection size and distance using the actual projector before you permanently install it.

LSC600W-ST | LSC601W-ST | LSC600WU-ST | LSC601WU-ST

16:10 Image on a 16:10 Screen

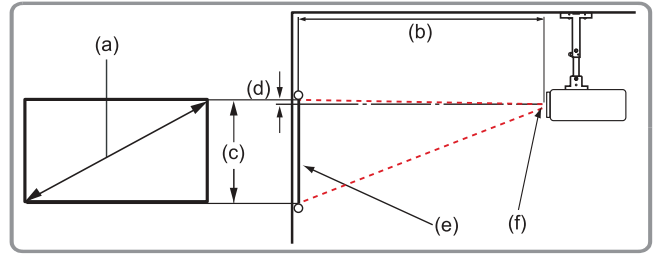
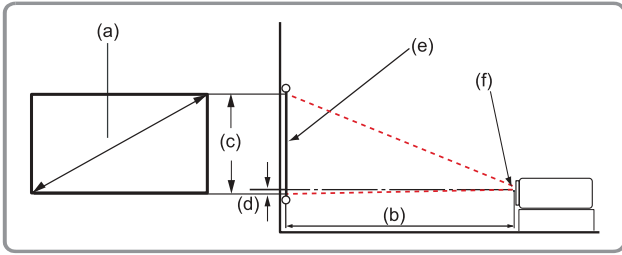

NOTE: (e) = Screen / (f) = Center of Lens

(a) Screen Size		(b) Projection Distance				(c) Image Height		(d) Vertical Offset	
		Minimum		Maximum					
in.	mm	in.	mm	in.	mm	in.	mm	in.	mm
55	1397	20	514	20	514	29	740	-0.28	-7
60	1524	22	568	22	568	32	808	-0.31	-8
70	1778	26	668	26	668	37	942	-0.35	-9
80	2032	30	769	30	769	42	1077	-0.43	-11
90	2286	34	869	34	869	48	1212	-0.47	-12
100	2540	38	969	38	969	53	1346	-0.55	-14
130	3302	50	1265	50	1265	69	1750	-0.71	-18
150	3810	56	1422	56	1422	80	2020	-0.79	-20
180	4572	67	1706	67	1706	95	2423	-0.94	-24

NOTE:

- These figures are for reference purposes only. Please refer to the actual projector for the precise dimensions.
- It is recommended that if you intend to permanently install the projector to physically test the projection size and distance using the actual projector before you permanently install it.

16:10 Image on a 4:3 Screen

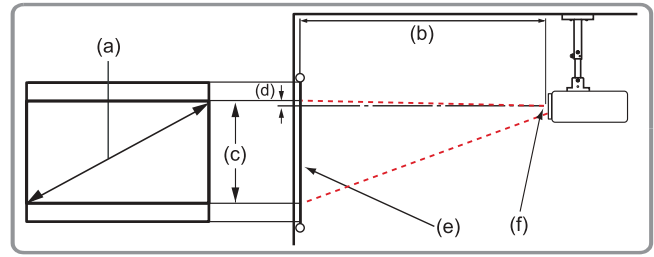
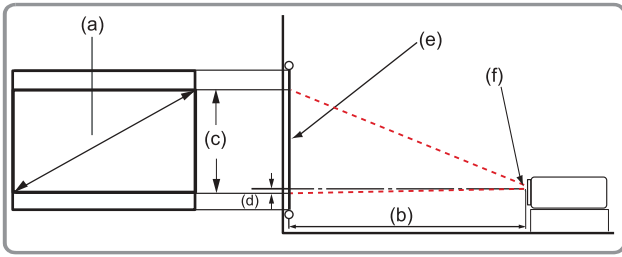

NOTE: (e) = Screen / (f) = Center of Lens

(a) Screen Size		(b) Projection Distance				(c) Image Height		(d) Vertical Offset	
		Minimum		Maximum					
in.	mm	in.	mm	in.	mm	in.	mm	in.	mm
60	1524	21.10	536	21.10	536	30.00	762	-0.28	-7
70	1778	24.65	626	24.65	626	35.00	889	-0.35	-9
80	2032	28.17	715	28.17	715	39.96	1015	-0.40	-10
90	2286	31.68	805	31.68	805	45.00	1143	-0.45	-11
100	2540	35.21	894	35.21	894	50.00	1270	-0.50	-13
130	3302	45.77	1163	45.77	1163	65.00	1651	-0.65	-16
150	3810	52.81	1341	52.81	1341	75.00	1905	-0.75	-19
180	4572	63.37	1610	63.37	1610	90.00	2286	-0.90	-23

NOTE:

- These figures are for reference purposes only. Please refer to the actual projector for the precise dimensions.
- It is recommended that if you intend to permanently install the projector to physically test the projection size and distance using the actual projector before you permanently install it.

LSC730WU-ST | LSC731WU-ST

16:10 Image on a 16:10 Screen

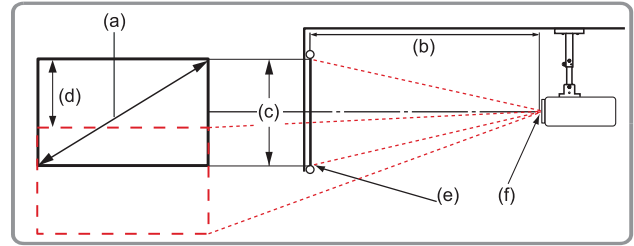
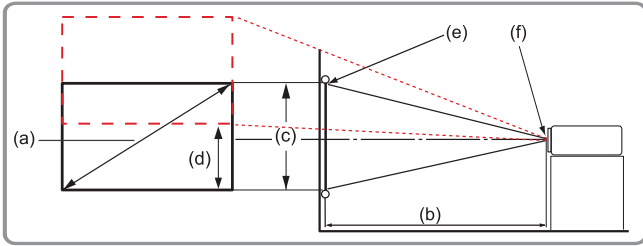

NOTE: (e) = Screen / (f) = Center of Lens

(a) Screen Size		(b) Projection Distance				(c) Image Height		(d) Vertical Offset	
		Minimum		Maximum					
in.	mm	in.	mm	in.	mm	in.	mm	in.	mm
50	1270	28.78	731	34.80	884	26.50	673	13.25	337
60	1524	34.57	878	41.77	1061	31.80	808	15.90	404
70	1778	40.28	1023	48.74	1238	37.10	942	18.55	471
80	2032	46.08	1170	55.71	1415	42.40	1077	21.20	539
90	2286	51.81	1316	62.64	1591	47.70	1212	23.85	606
100	2540	57.60	1463	69.61	1768	53.00	1346	26.50	673
150	3810	86.38	2194	104.45	2653	79.50	2019	39.75	1010
200	5080	115.16	2925	139.25	3537	106.00	2692	53.00	1346
250	6350	143.94	3656	174.06	4421	132.50	3366	66.25	1683
300	7620	172.76	4388	208.86	5305	159.00	4039	79.50	2019

NOTE:

- These figures are for reference purposes only. Please refer to the actual projector for the precise dimensions.
- It is recommended that if you intend to permanently install the projector to physically test the projection size and distance using the actual projector before you permanently install it.

16:10 Image on a 4:3 Screen

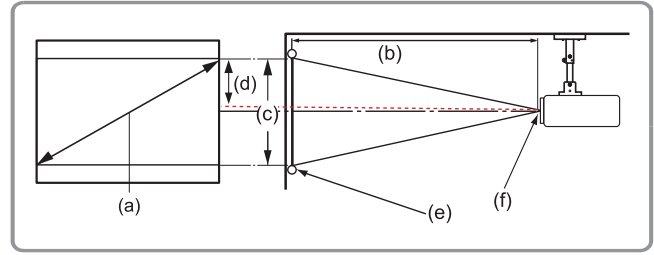
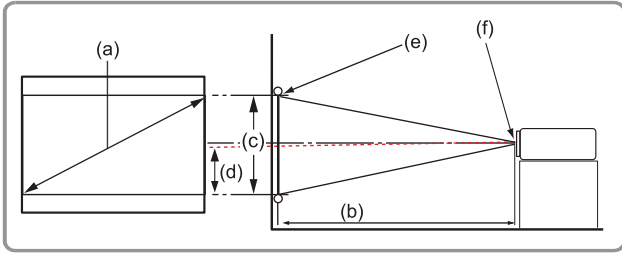

NOTE: (e) = Screen / (f) = Center of Lens

(a) Screen Size		(b) Projection Distance				(c) Image Height		(d) Vertical Offset	
		Minimum		Maximum					
in.	mm	in.	mm	in.	mm	in.	mm	in.	mm
50	1270	27.17	690	32.83	834	25.00	635	12.50	318
60	1524	32.52	826	39.33	999	29.96	761	14.98	381
70	1778	37.99	965	45.94	1167	34.96	888	17.48	444
80	2032	43.46	1104	52.56	1335	40.00	1016	20.00	508
90	2286	48.86	1241	59.09	1501	45.00	1143	22.50	572
100	2540	54.29	1379	65.67	1668	49.96	1269	24.98	635
150	3810	81.46	2069	98.50	2502	75.00	1905	37.50	953
200	5080	108.66	2760	131.38	3337	100.00	2540	50.00	1270
250	6350	135.79	3449	164.17	4170	124.96	3174	62.48	1587
300	7620	162.95	4139	197.01	5004	150.00	3810	75.00	1905

NOTE:

- These figures are for reference purposes only. Please refer to the actual projector for the precise dimensions.
- It is recommended that if you intend to permanently install the projector to physically test the projection size and distance using the actual projector before you permanently install it.

LSC600-4K | LSC601-4K | LSC700-4K | LSC701-4K

16:9 Image on a 16:9 Screen

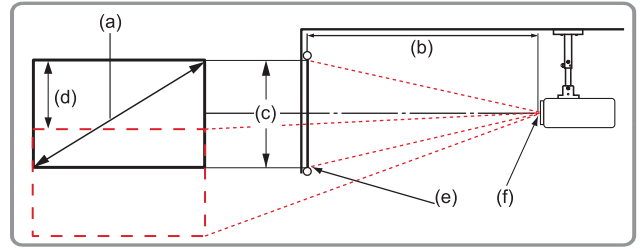
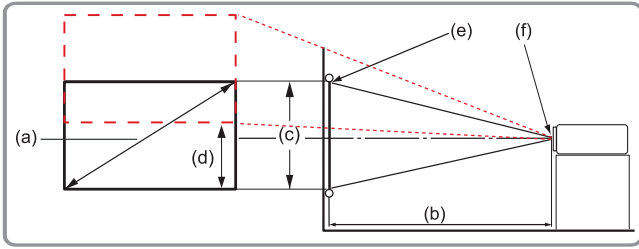

NOTE: (e) = Screen / (f) = Center of Lens

(a) Screen Size		(b) Projection Distance				(c) Image Height		(d) Vertical Offset	
		Minimum		Maximum					
in.	mm	in.	mm	in.	mm	in.	mm	in.	mm
30	762	31.38	797	52.56	1335	14.71	374	9.71	247
60	1524	62.75	1594	105.11	2670	29.42	747	19.42	493
70	1778	73.21	1860	122.63	3115	34.32	872	22.65	575
80	2032	83.67	2125	140.15	3560	39.22	996	25.89	657
90	2286	94.13	2391	157.67	4005	44.12	1121	29.12	740
100	2540	104.59	2657	175.19	4450	49.03	1245	32.36	822
120	3048	125.51	3188	210.22	5340	58.83	1494	38.83	986
150	3810	156.88	3985	262.78	6675	73.54	1868	48.54	1233
180	4572	188.26	4782	315.34	8010	88.25	2242	58.25	1479
200	5080	209.18	5313	350.37	8899	98.05	2490	64.71	1644
250	6350	261.47	6641	437.97	11124	122.57	3113	80.90	2055
300	7620	313.77	7970	525.56	13349	147.08	3736	97.07	2466

NOTE:

- These figures are for reference purposes only. Please refer to the actual projector for the precise dimensions.
- It is recommended that if you intend to permanently install the projector to physically test the projection size and distance using the actual projector before you permanently install it.

16:9 Image on a 4:3 Screen

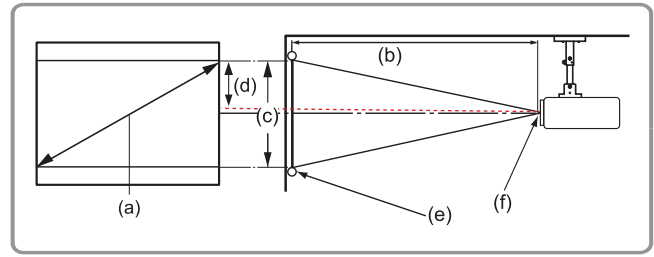
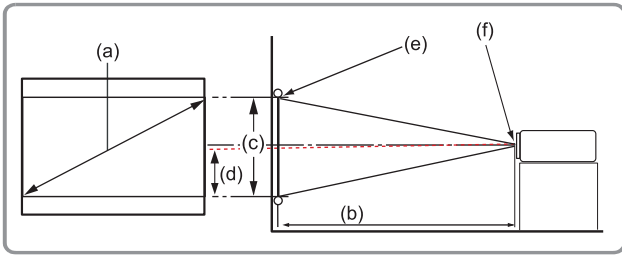

NOTE: (e) = Screen / (f) = Center of Lens

(a) Screen Size		(b) Projection Distance				(c) Image Height		(d) Vertical Offset	
		Minimum		Maximum					
in.	mm	in.	mm	in.	mm	in.	mm	in.	mm
30	762	28.78	731	48.23	1225	13.50	343	8.91	226
60	1524	57.60	1463	96.50	2451	27.01	686	17.83	453
70	1778	67.28	1709	98.50	2863	31.54	801	20.81	529
80	2032	76.81	1951	128.62	3267	35.98	914	23.75	603
90	2286	86.45	2196	144.76	3677	40.50	1029	26.73	679
100	2540	96.06	2440	160.85	4086	45.00	1143	29.70	754
120	3048	115.27	2928	193.02	4903	54.00	1372	35.64	905
150	3810	144.08	3660	241.27	6128	67.50	1714	44.55	1132
180	4572	172.90	4392	289.53	7354	81.00	2057	53.46	1358
200	5080	192.11	4880	321.69	8171	90.00	2286	59.40	1509
250	6350	240.14	6100	402.12	10214	112.50	2857	74.25	1886
300	7620	288.17	7319	482.54	12257	135.00	3429	89.10	2263

NOTE:

- These figures are for reference purposes only. Please refer to the actual projector for the precise dimensions.
- It is recommended that if you intend to permanently install the projector to physically test the projection size and distance using the actual projector before you permanently install it.

Mounting the Projector

NOTE: If you buy a third party mount, please use the correct screw size. Screw size can vary depending on the thickness of the mounting plate.

1. To ensure the most secure installation, please use a ViewSonic® wall or ceiling mount.
2. Ensure the screws used to attach the mount to the projector meet the following specifications:
 - Screw type: M4 x 8
 - Maximum Screw Length: 8 mm

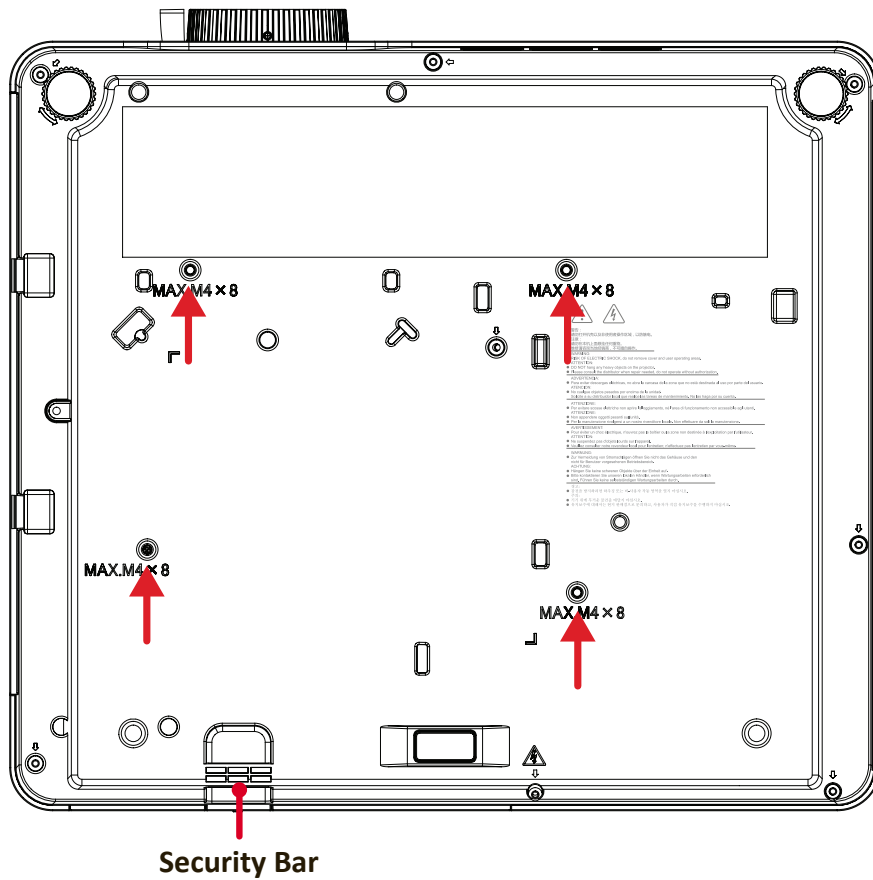

CAUTION:

- Avoid installing the projector near a heat source or air conditioner.
- Keep at least a 50 cm (19.6 in.) gap between the ceiling and the bottom of the projector.

Using the Security Bar

To help prevent the projector from being stolen, use a security slot locking device to secure the projector to a fixed object.

Making Connections

Connecting to Power

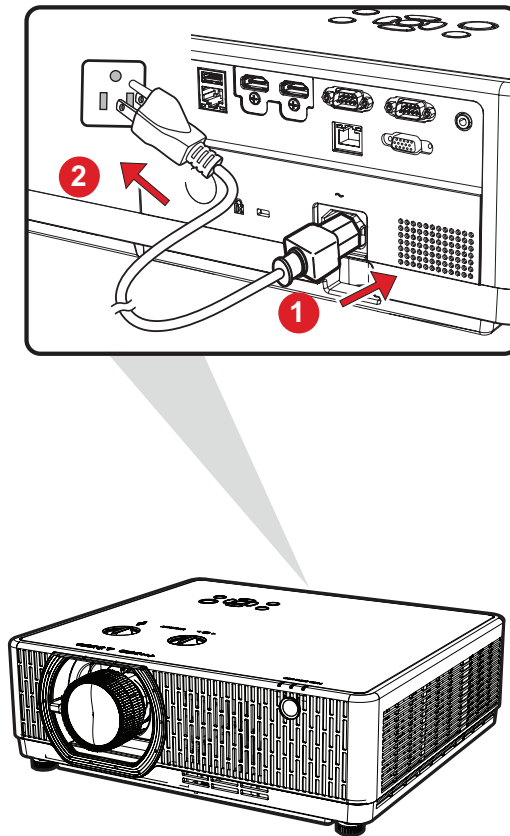

1. Connect the power cord to the AC IN socket at the rear of the projector.
2. Plug the power cord into a power outlet.

NOTE: When installing the projector, incorporate a readily accessible disconnect device in the fixed wiring, or connect the power plug to an easily accessible outlet near the unit. If a fault should occur during operation of the projector, use the disconnect device to switch off the power supply, or disconnect the power plug.

Connecting to External Devices

VGA Connection¹

Connect one end of a VGA cable to the VGA port of the computer. Then connect the other end of the cable to the **COMPUTER** port of the projector.

NOTE: Some computers do not turn on their external displays automatically when connected to a projector. You may have to adjust your computer's projection settings.

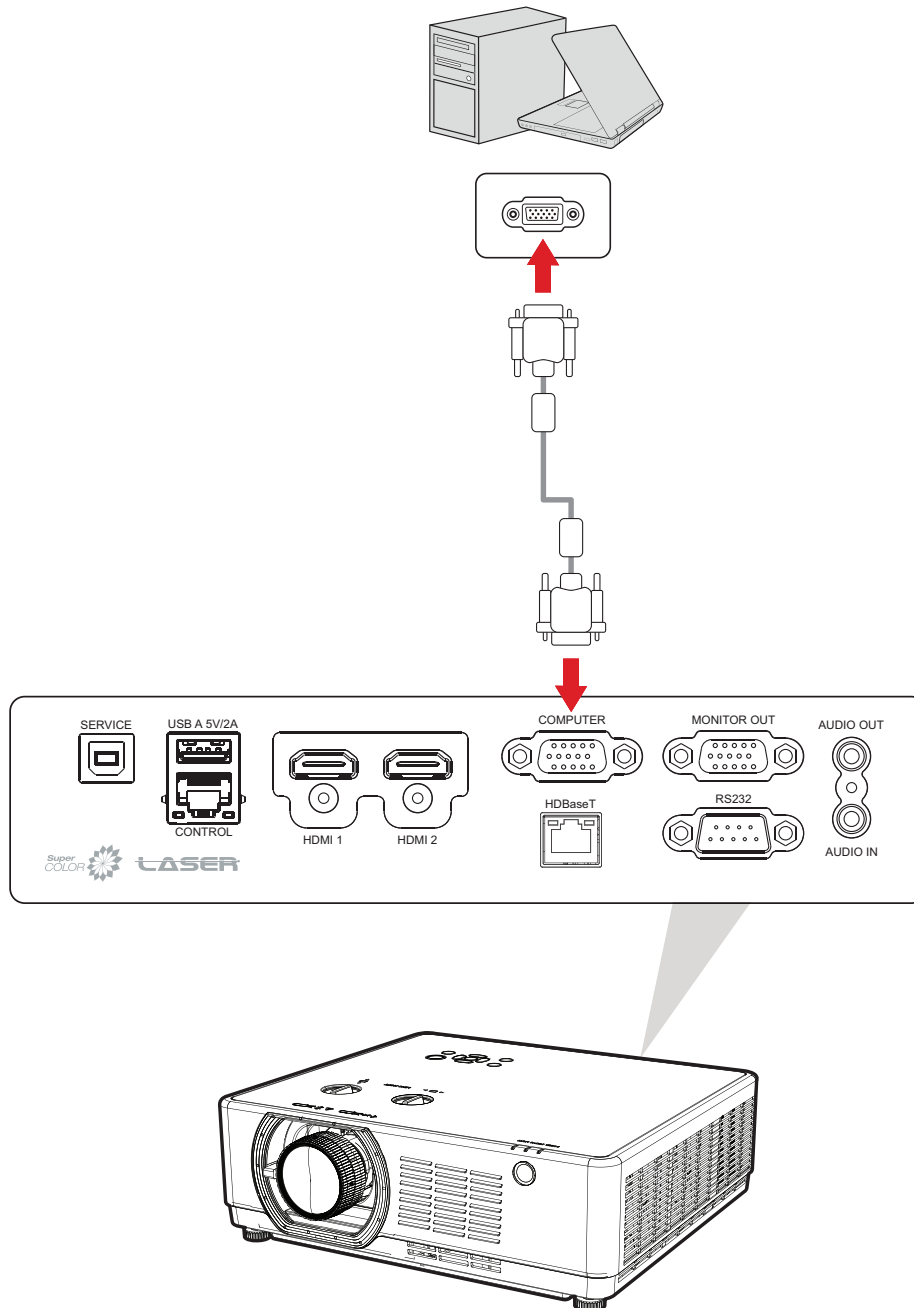

¹ - Only for LSC600W-ST, LSC601W-ST, LSC600WU-ST, LSC601WU-ST, LSC730WU-ST, LSC731WU-ST, LSC600WU, LSC601WU, LSC650WU, LSC651WU, LSC730WU, LSC731WU, LSC800WU, and LSC801WU.

VGA Out Connection²

To view the projected content up close on a monitor as well as project it, a monitor can be connected to the **MONITOR OUT** port of the projector.

After establishing the VGA Connection, connect one end of a VGA cable to the VGA port of your monitor. Then connect the other end of the cable to the **MONITOR OUT** port of your projector.

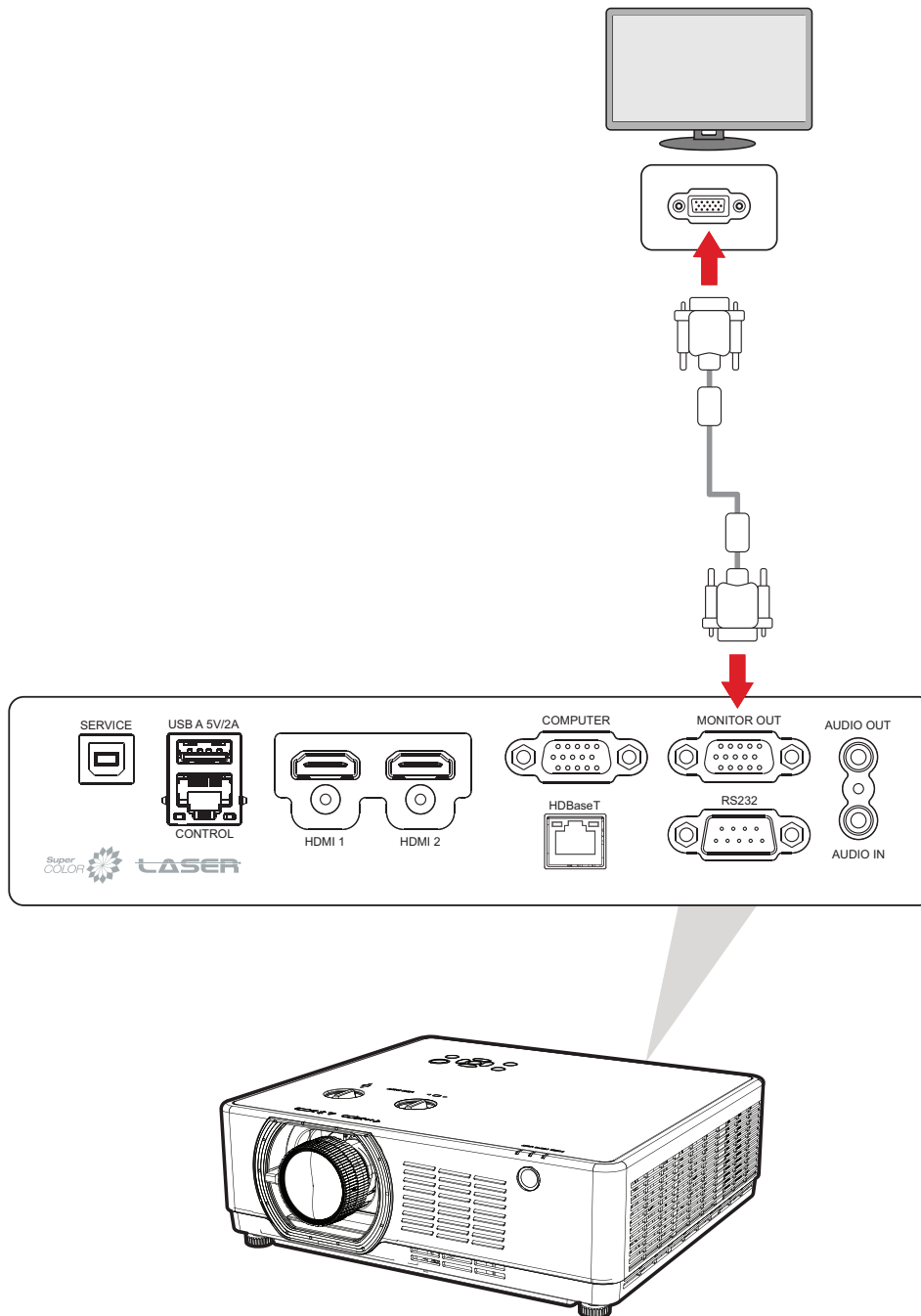

² - Only for LSC600W-ST, LSC601W-ST, LSC600WU-ST, LSC601WU-ST, LSC730WU-ST, LSC731WU-ST, LSC600WU, LSC601WU, LSC650WU, LSC651WU, LSC730WU, LSC731WU, LSC800WU, and LSC801WU.

HDMI Connection

Connect one end of an HDMI cable to the HDMI port of your video device. Then connect the other end of the cable to the **HDMI 1** or **HDMI 2** port³ of your projector.

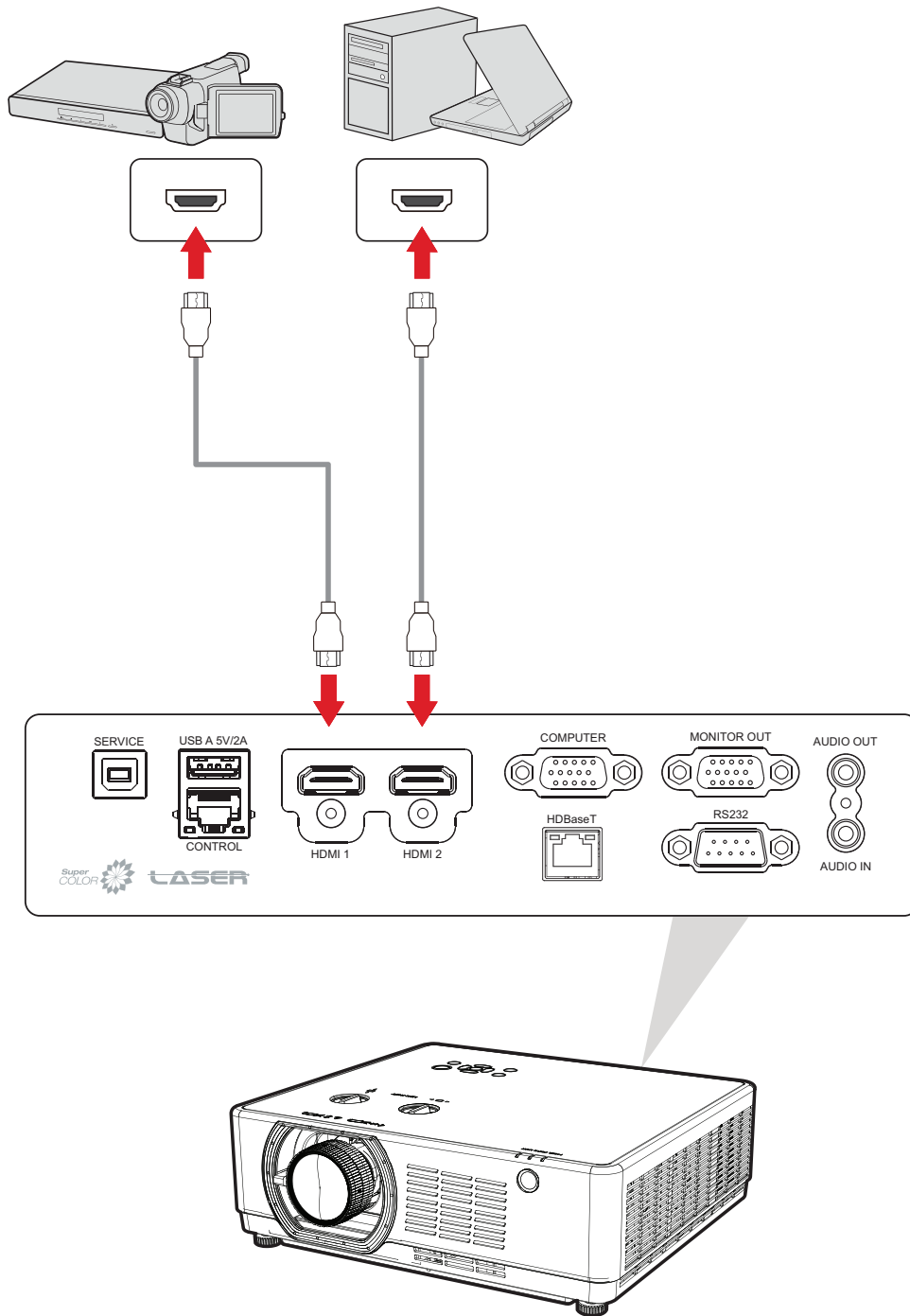

³ - HDCP 2.2 is only supported on LSC600-4K, LSC601-4K, LSC700-4K, and LSC701-4K.

Audio Connection

The projector supports both Audio In and Audio Out.

Audio In⁴

To play audio from your external device through the projector's speakers, connect one end of an audio cable to your external device, and the other end to the projector's **AUDIO IN** port.

Audio Out

To play audio from the projector through an external speaker, connect one end of an audio cable to the external speaker, and the other end to the projector's **AUDIO OUT** port.

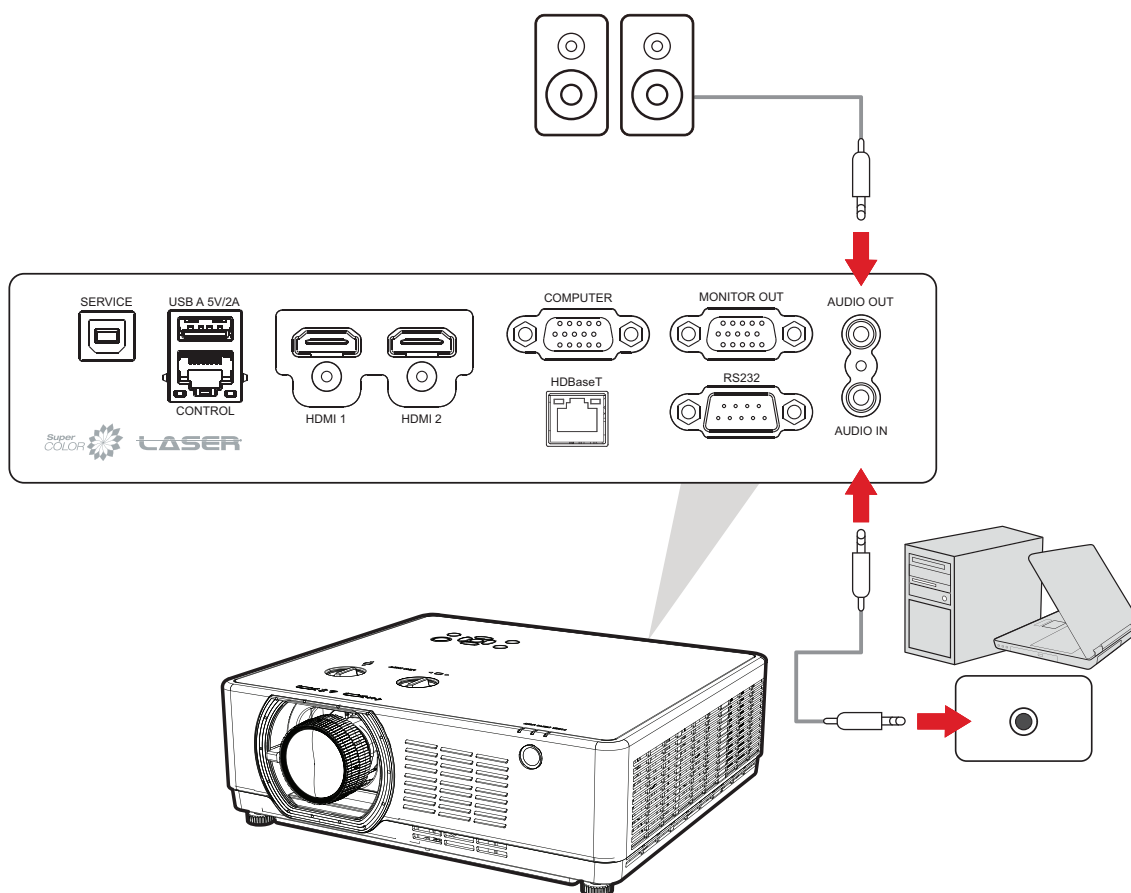

4 - Only for LSC600W-ST, LSC601W-ST, LSC600WU-ST, LSC601WU-ST, LSC730WU-ST, LSC731WU-ST, LSC600WU, LSC601WU, LSC650WU, LSC651WU, LSC730WU, LSC731WU, LSC800WU, and LSC801WU.

S/PDIF⁵

To play audio from the projector through an external speaker, connect one end of an audio cable to the external speaker, and the other end to the projector's **S/PDIF** port.

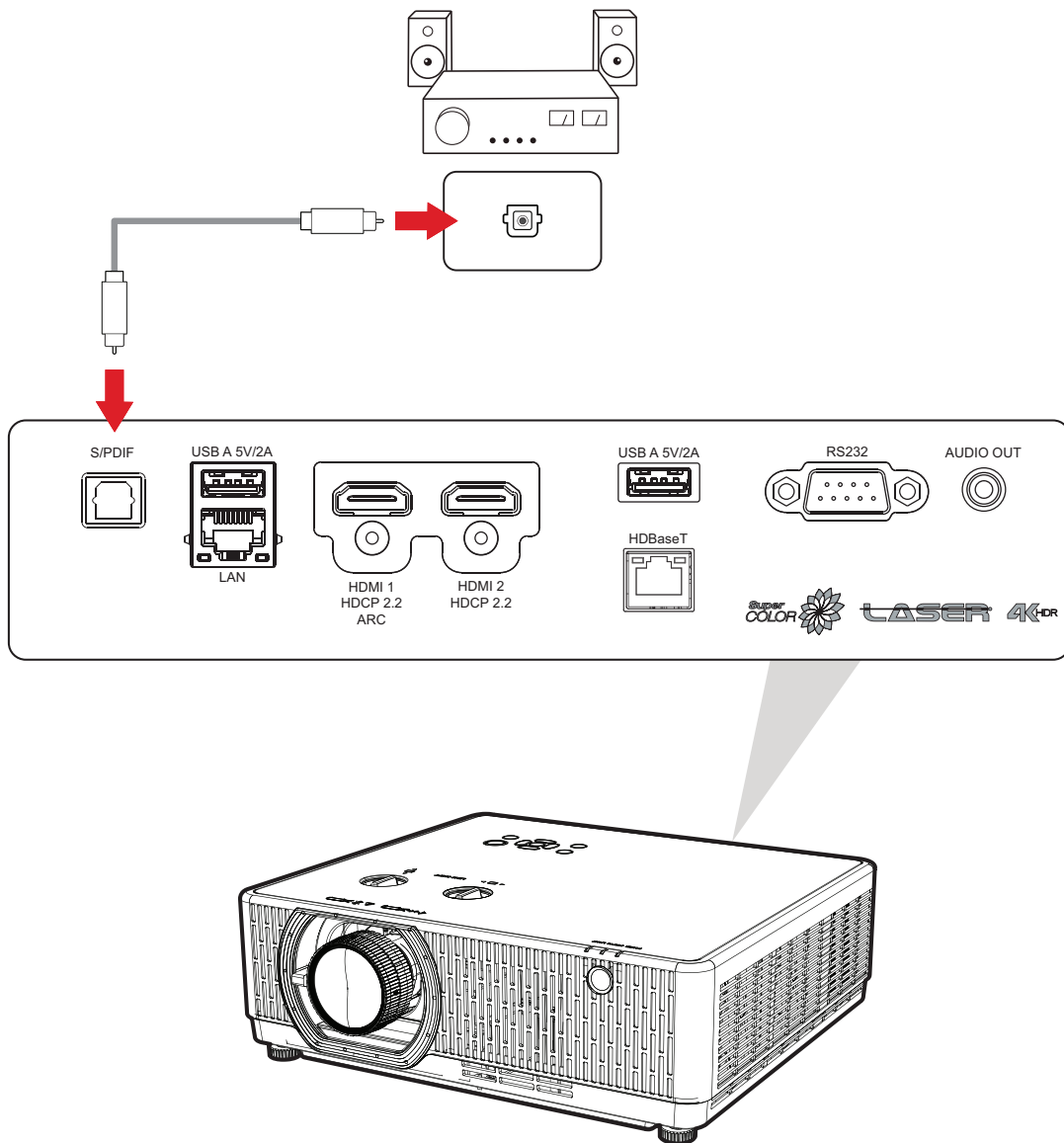

NOTE: The **HDMI 1** port supports ARC⁵. It can deliver sound to external devices via the **HDMI 1** port. Please make sure **HDMI ARC** is set to **On** in the OSD Menu.

⁵ - Only for LSC600-4K, LSC601-4K, LSC700-4K, and LSC701-4K.

USB Connection

USB Type A⁶

The USB Type A port is for reader (FAT32) and supplying power.

USB Type B⁷

The USB Type B port is for service and USB display.

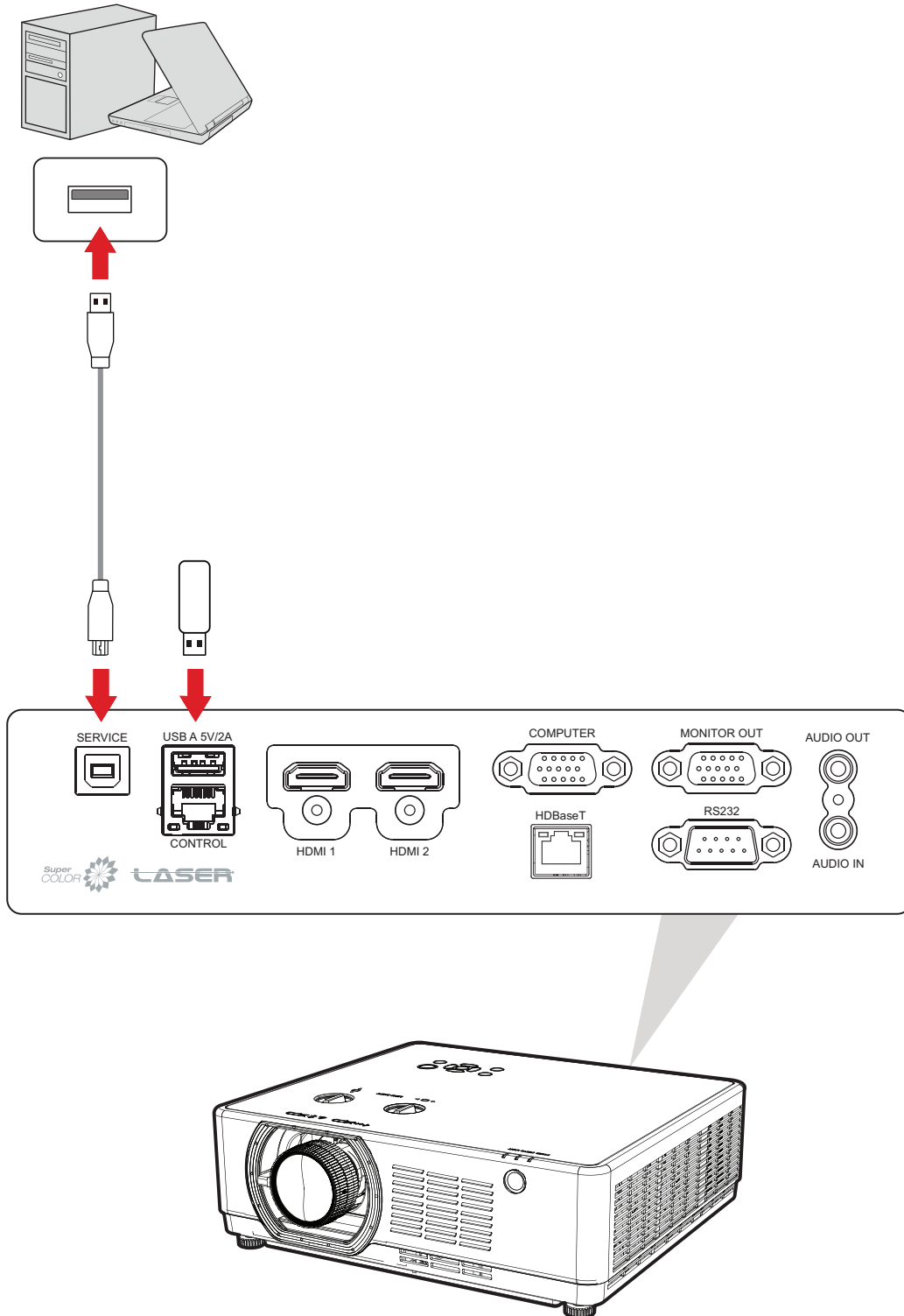

6- The USB Type A port supports firmware update for LSC600-4K, LSC601-4K, LSC700-4K, and LSC701-4K. Please check the OSD setting, **Firmware Update by USB**.

7- Only for LSC600W-ST, LSC601W-ST, LSC600WU-ST, LSC601WU-ST, LSC730WU-ST, LSC731WU-ST, LSC600WU, LSC601WU, LSC650WU, LSC651WU, LSC730WU, LSC731WU, LSC800WU, and LSC801WU.

USB Display

USB Display will output the computer's audio and image.

1. Connect one end of a USB Type B cable to the USB port of your computer. Then connect the other end of the cable to the **SERVICE** port of your projector.
2. Once connected, the computer will automatically detect the pwPresenter driver from the projector. Select autorun.exe to install the driver.
3. On the remote control, press the **Input** button and select **USB B** from the input source menu to display the computer's image.

Network Connection

Plug the network cable into the **CONTROL**⁸ or **LAN**⁹ port for network connectivity.

The projector provides several networking and remote management features. The LAN /RJ45 function of the projector, through a network, can control the projector remotely.

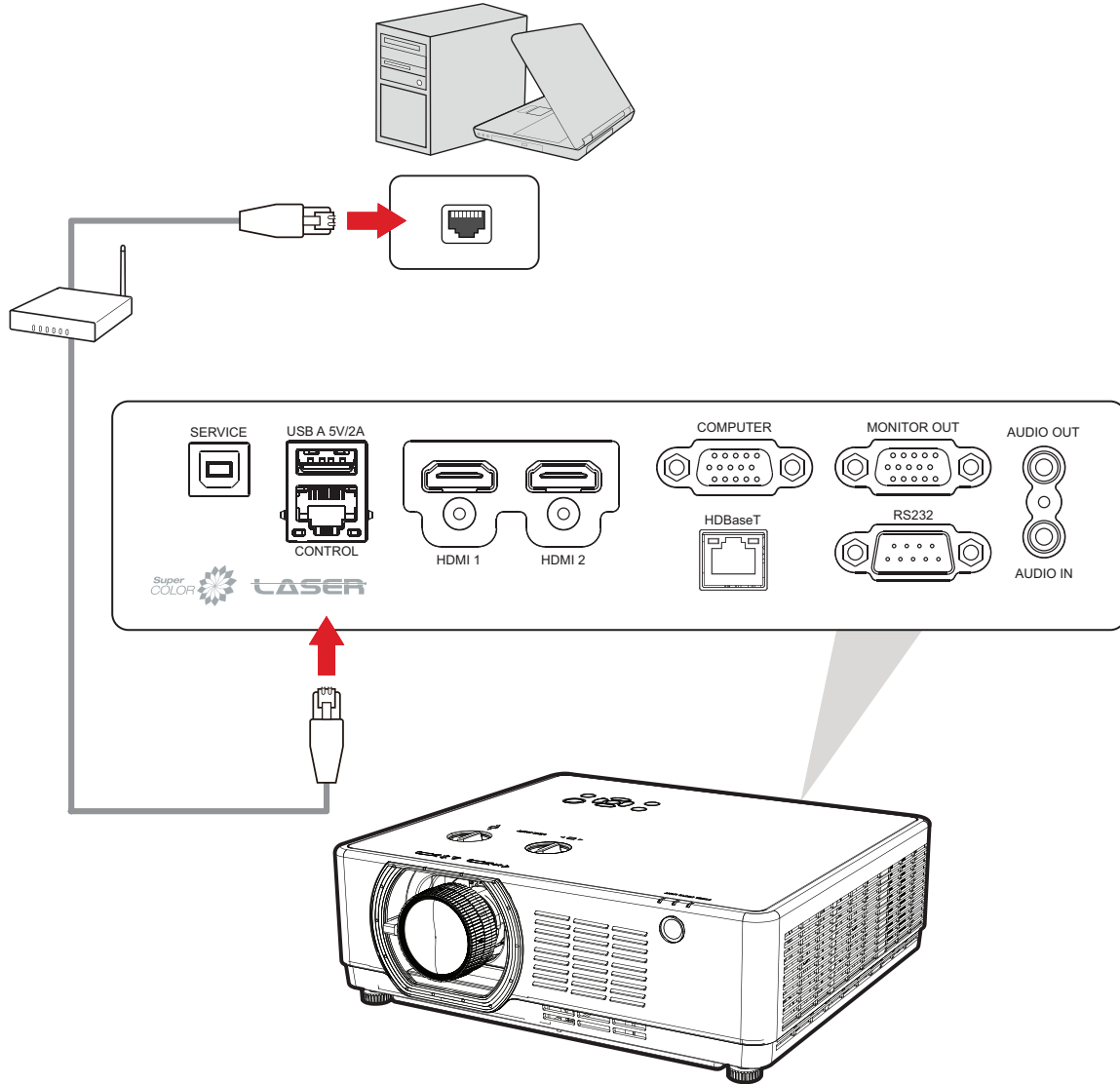

8 - Only for LSC600W-ST, LSC601W-ST, LSC600WU-ST, LSC601WU-ST, LSC730WU-ST, LSC731WU-ST, LSC600WU, LSC601WU, LSC650WU, LSC651WU, LSC730WU, LSC731WU, LSC800WU, and LSC801WU.

9 - Only for LSC600-4K, LSC601-4K, LSC700-4K, and LSC701-4K.

RS-232 Connection

When you use a RS-232 serial port cable to connect the projector to an external computer certain functions can be controlled remotely by the PC, including Power On/Off, Volume adjustment, Input select, Brightness, and more.

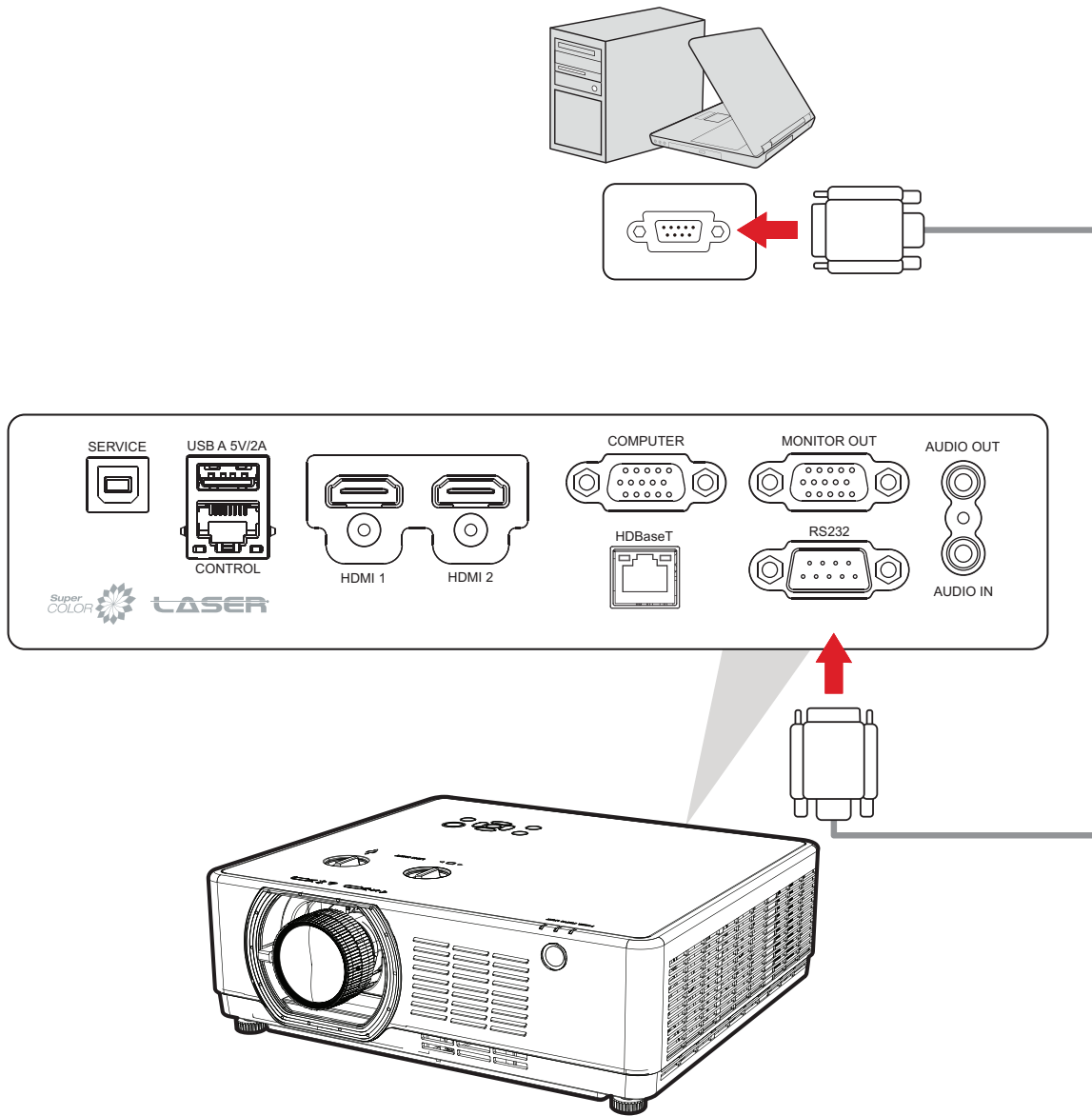

HDBaseT Connection

NOTE: HDBaseT is only available for LSC601WU, LSC651WU, LSC731WU, LSC801WU, LSC731WU-ST, LSC601W-ST, LSC601WU-ST, LSC601-4K, and LSC701-4K.

HDBaseT is a technology to transmit image signals through a LAN cable. Connect a Cat5e/Cat6 cable to the projector's **HDBaseT** port from an HDBaseT TX box. Then connect the HDBaseT TX box to an HDBaseT output (e.g., HD TV source, Blue-ray player, etc.).

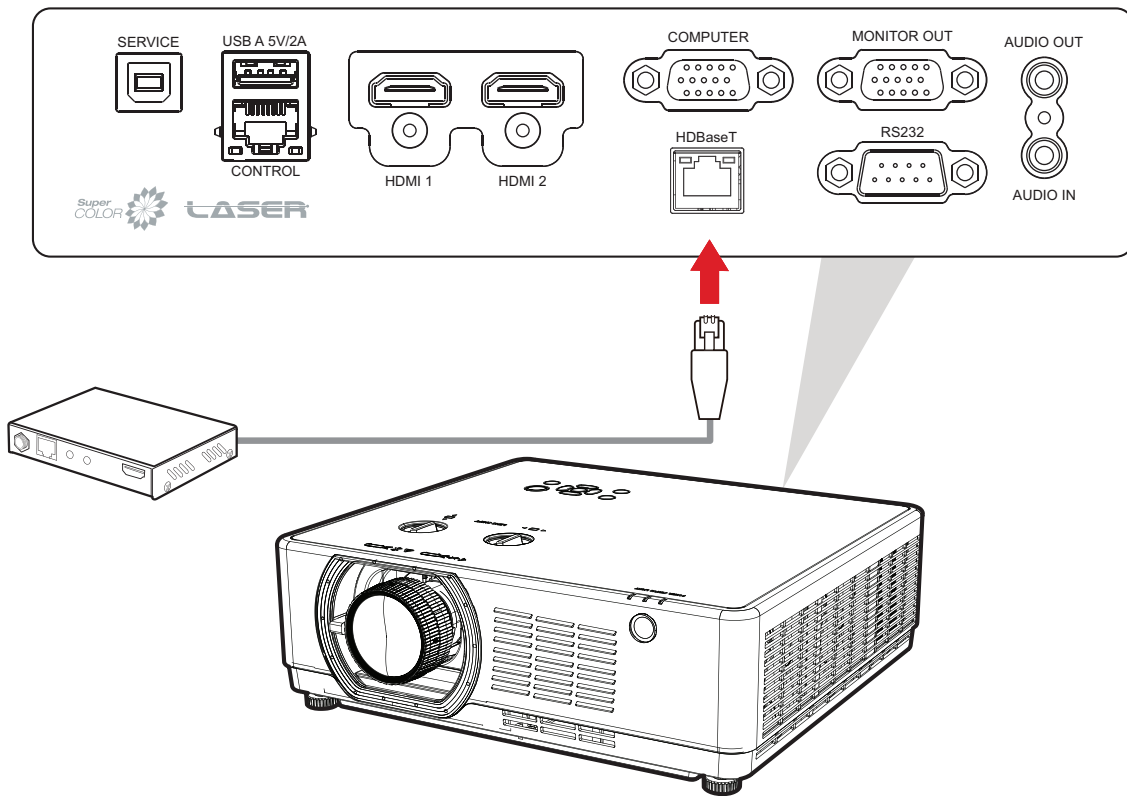

Using the Projector

Turning the Projector On

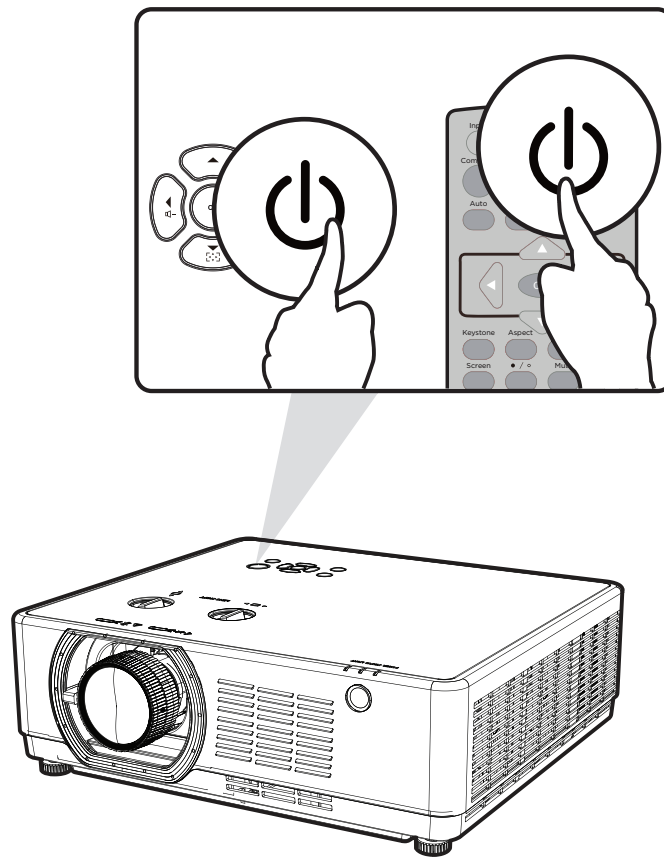

1. Make sure the projector's power cord is properly connected to a power outlet.
2. Press the **Power** button on the projector or remote control to turn on the projector.

NOTE:

- The Power Indicator Light will be flashing orange during startup.
- The first time the projector is turned on, you will be prompted to select the preferred language and projection orientation.

Selecting an Input Source

LSC600W-ST | LSC601W-ST | LSC600WU-ST | LSC601WU-ST | LSC730WU-ST | LSC731WU-ST | LSC600WU | LSC601WU | LSC650WU | LSC651WU | LSC730WU | LSC731WU | LSC800WU | LSC801WU

The projector can be connected to multiple devices at the same time. However, it can only display one full screen at a time.

NOTE: HDBaseT is only available for LSC601WU, LSC651WU, LSC731WU, LSC801WU, LSC731WU-ST, LSC601W-ST, and LSC601WU-ST.

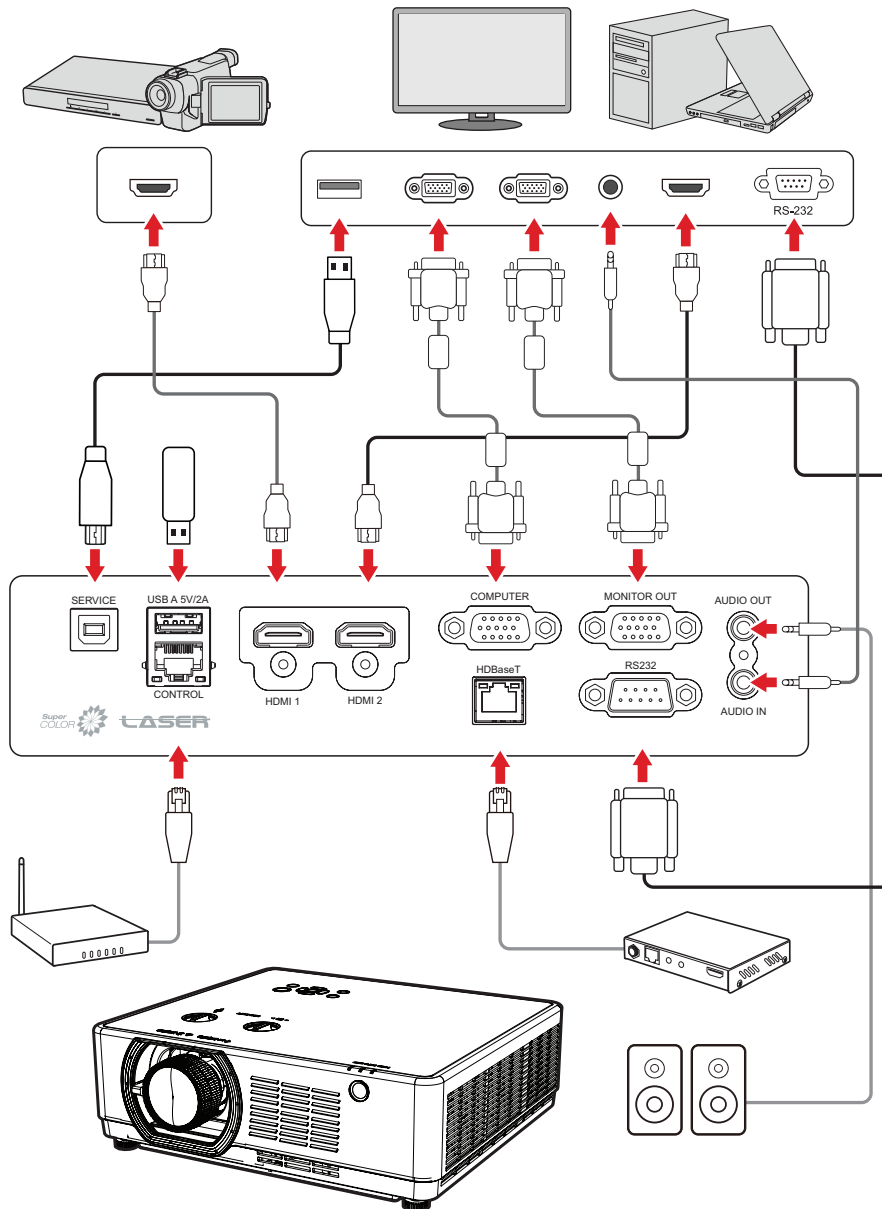

When **Input Search** is on, the projector will automatically search for input sources. If multiple sources are connected, press the **Input** button on the projector or remote control to select the desired input.

NOTE: Make sure the connected sources are also turned on.

LSC600-4K | LSC601-4K | LSC700-4K | LSC701-4K

The projector can be connected to multiple devices at the same time. However, it can only display one full screen at a time.

NOTE: HDBaseT is only available for LSC601-4K and LSC701-4K.

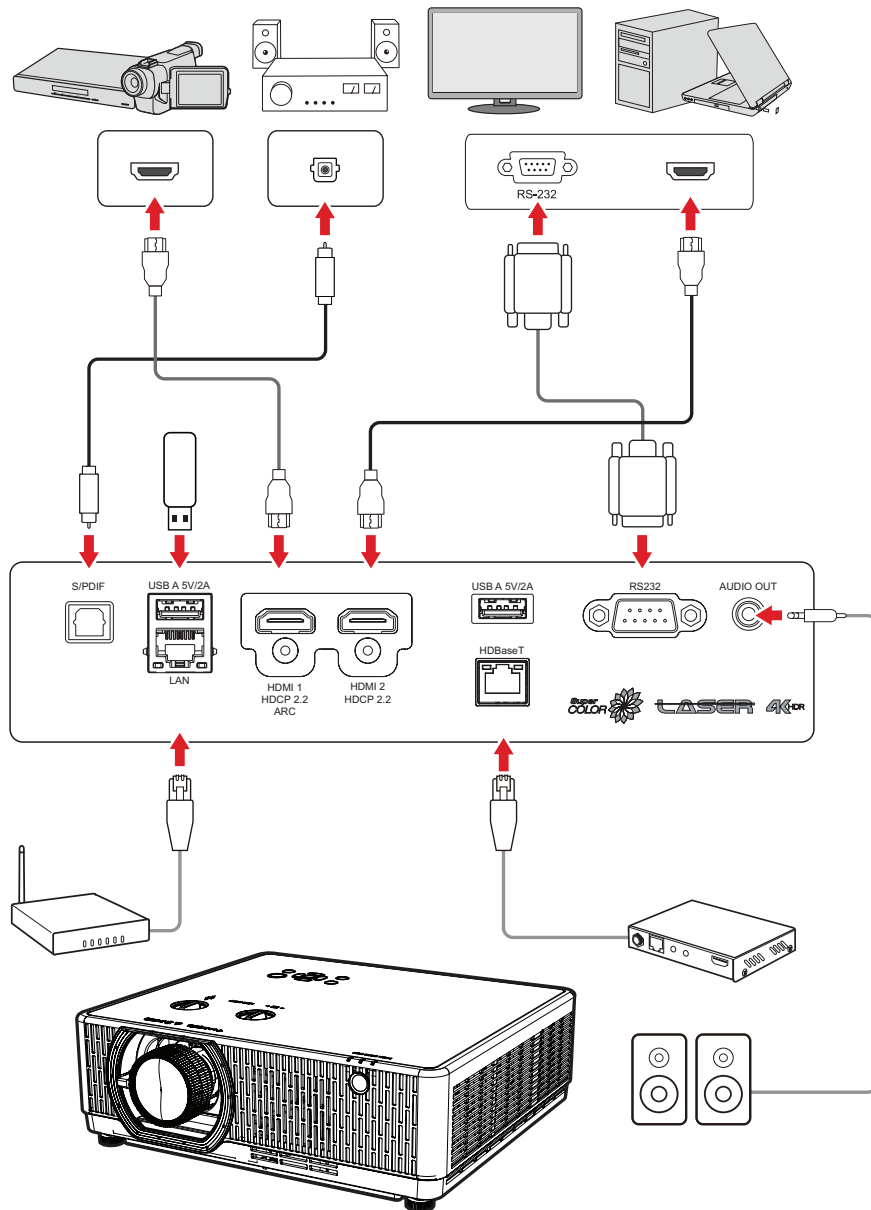

NOTE: Make sure the connected sources are also turned on.

Adjusting the Projected Image

Adjusting the Projector's Height and Projection Angle

The projector is equipped with two adjustment feet. Adjusting the feet will change the projector's height and the vertical projection angle.

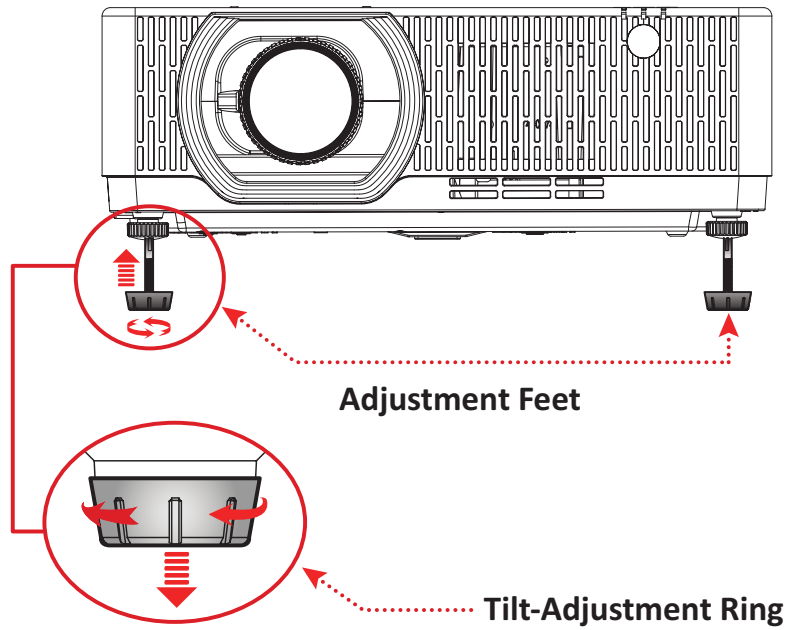

Fine-Tuning the Image Size and Clarity

To adjust the projected image to the size you need, rotate the **Zoom Ring**. You can also improve the clarity of the image by adjusting the **Focus Ring**.

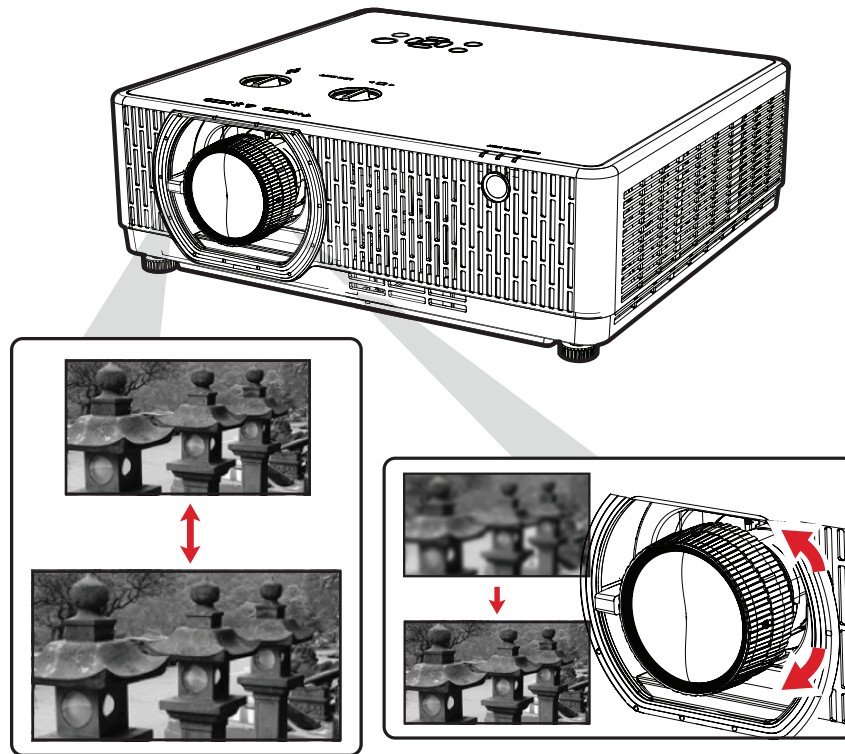

Controlling the Projected Image Position (Lens Shift)

The projection lens can be moved up, down, right, and left with the lens shift function by turning the **Lens Shift** dials. This function makes the positioning of images easy on the screen.

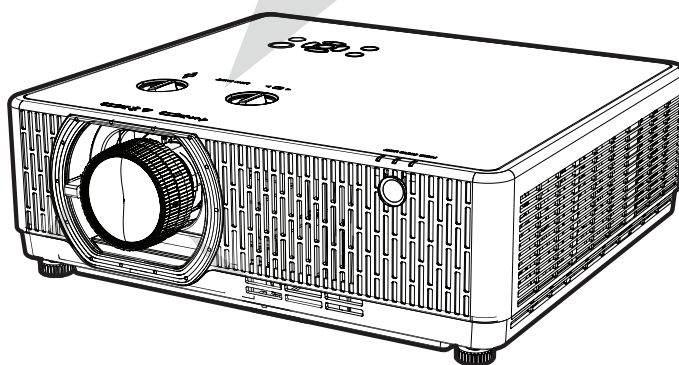
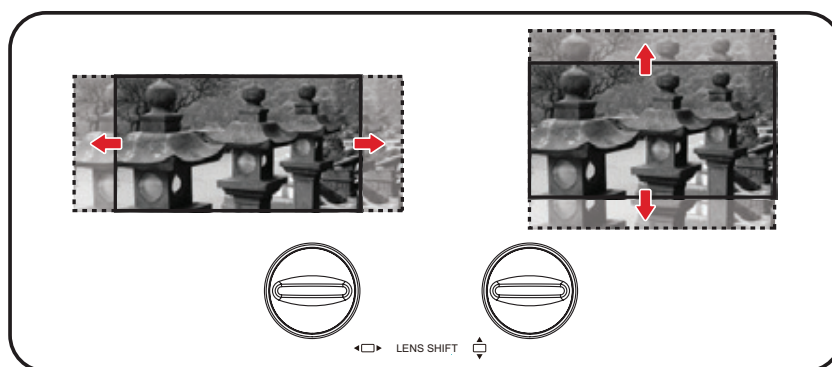

NOTE: For the clearest picture, please keep the vertical and horizontal **Lens Shift** dials centered.

Lens shift is generally expressed as a percentage of the image height or width, please see the below illustrations.

LSC600WU | LSC601WU

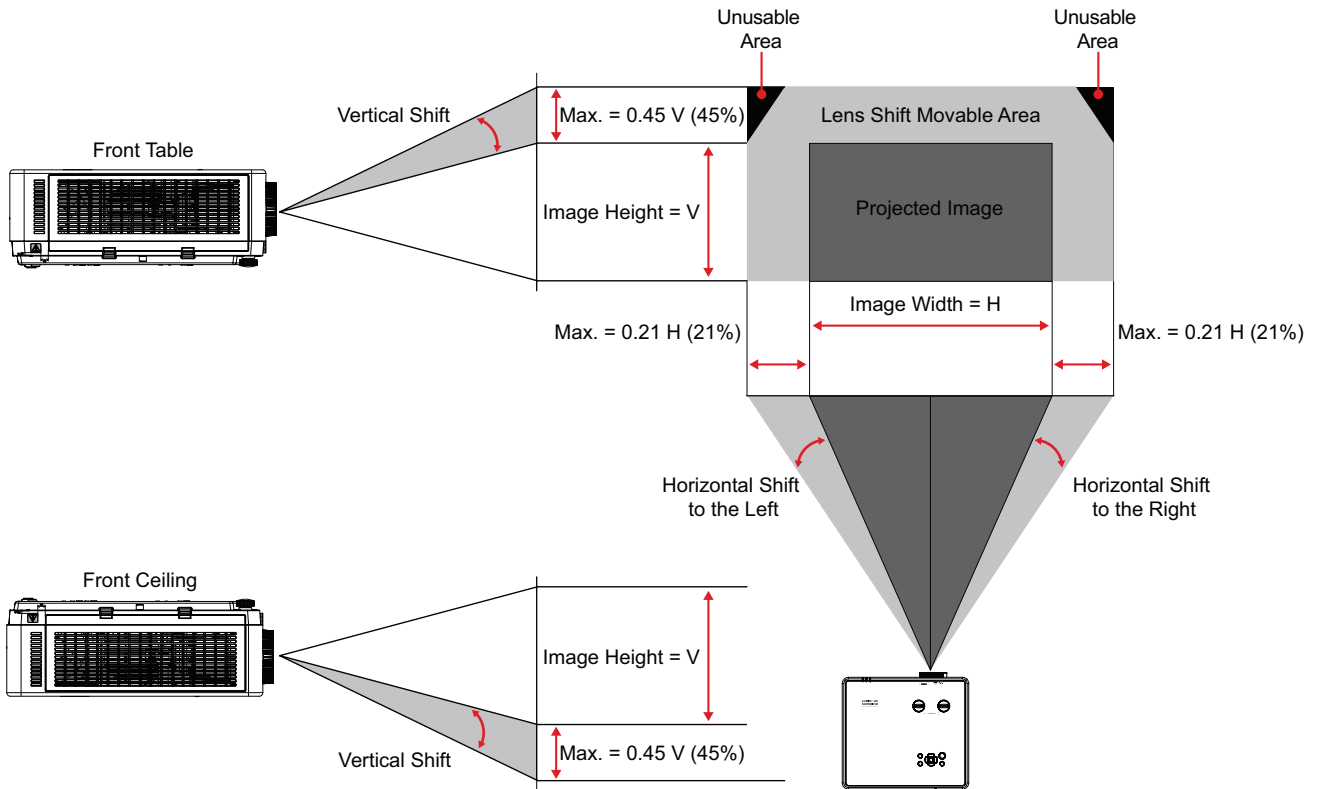

LSC650WU | LSC651WU | LSC730WU | LSC731WU | LSC800WU | LSC801WU

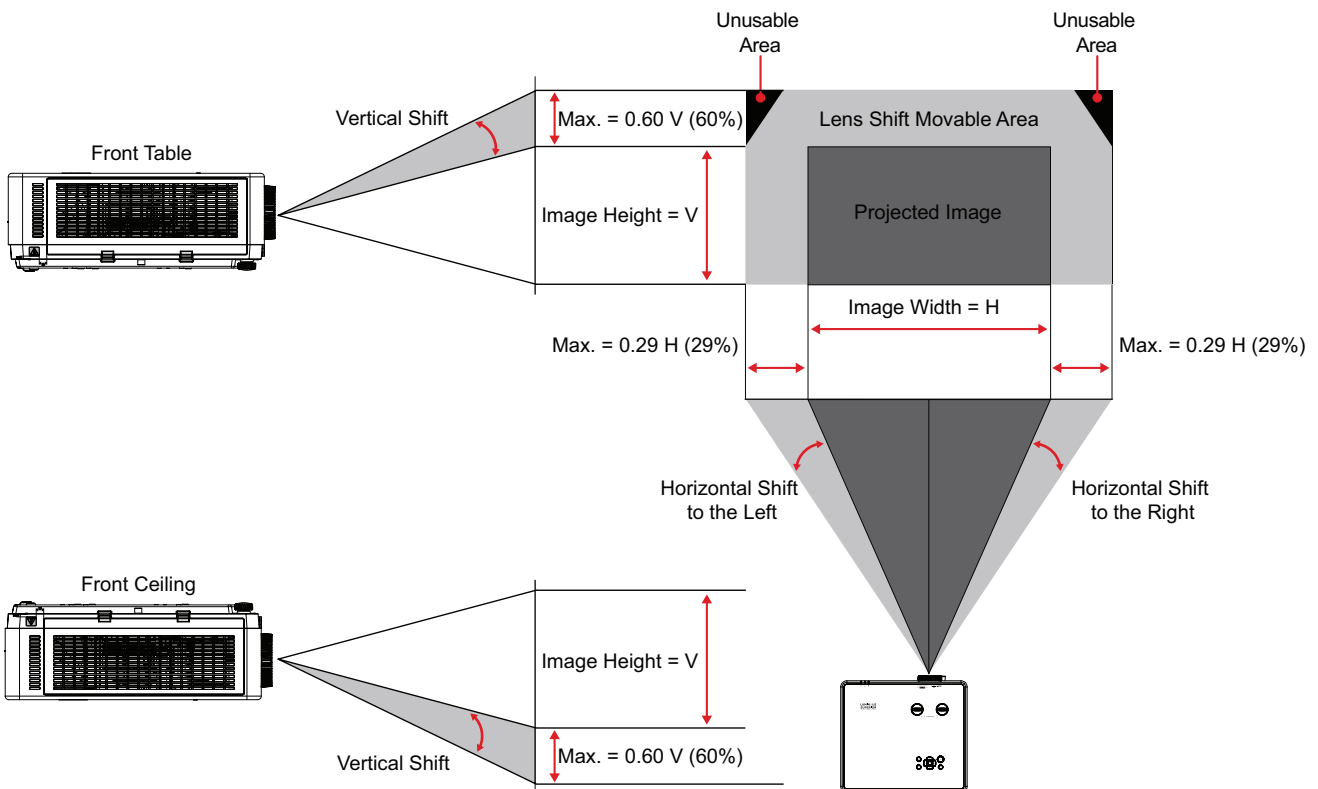

LSC600-4K | LSC601-4K | LSC700-4K | LSC701-4K

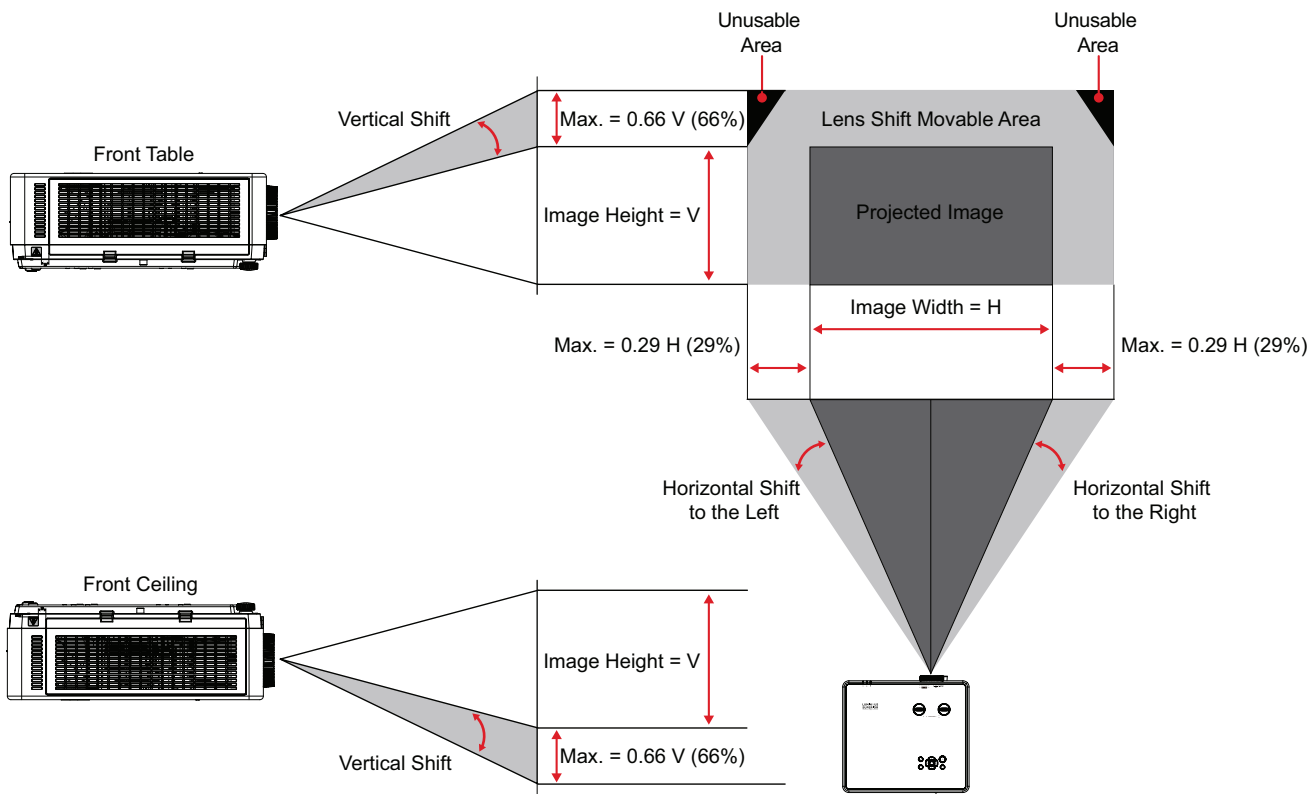

LSC730WU-ST | LSC731WU-ST

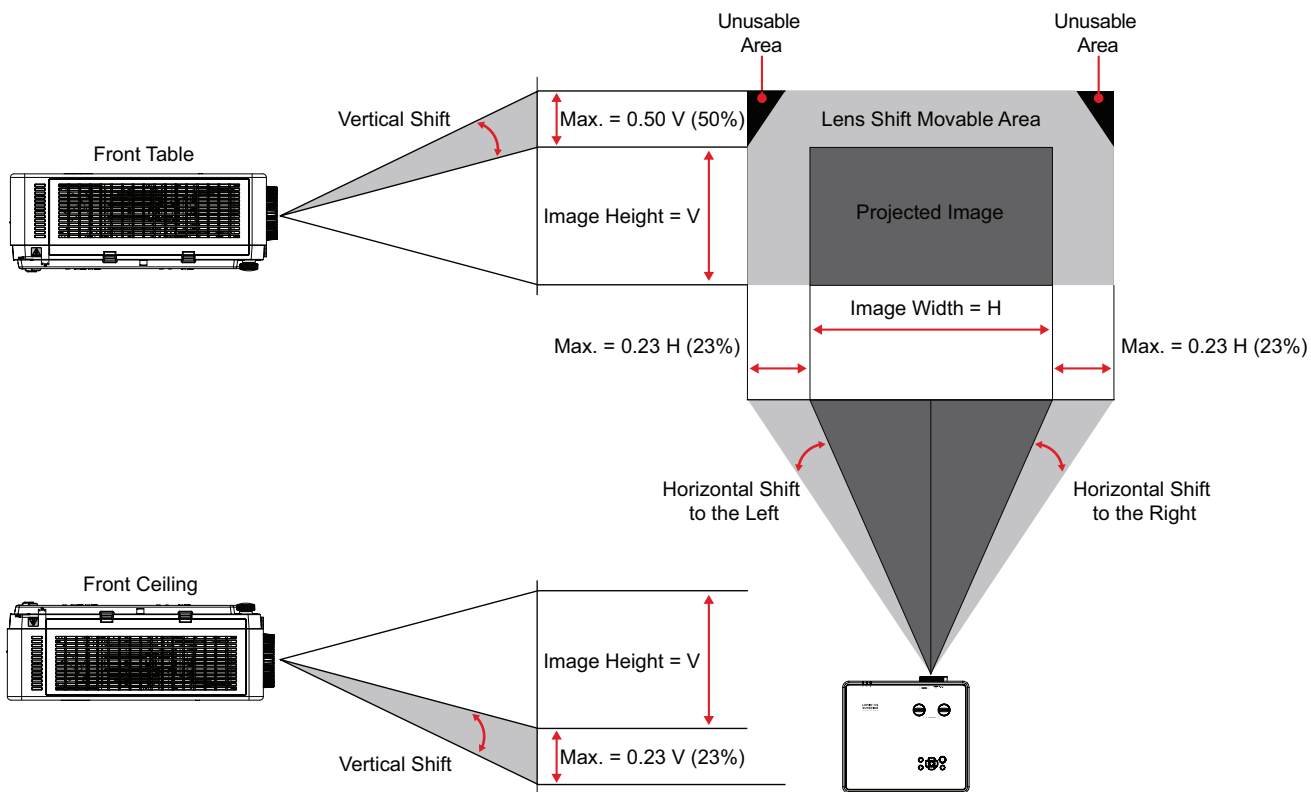

LSC600WU | LSC601WU

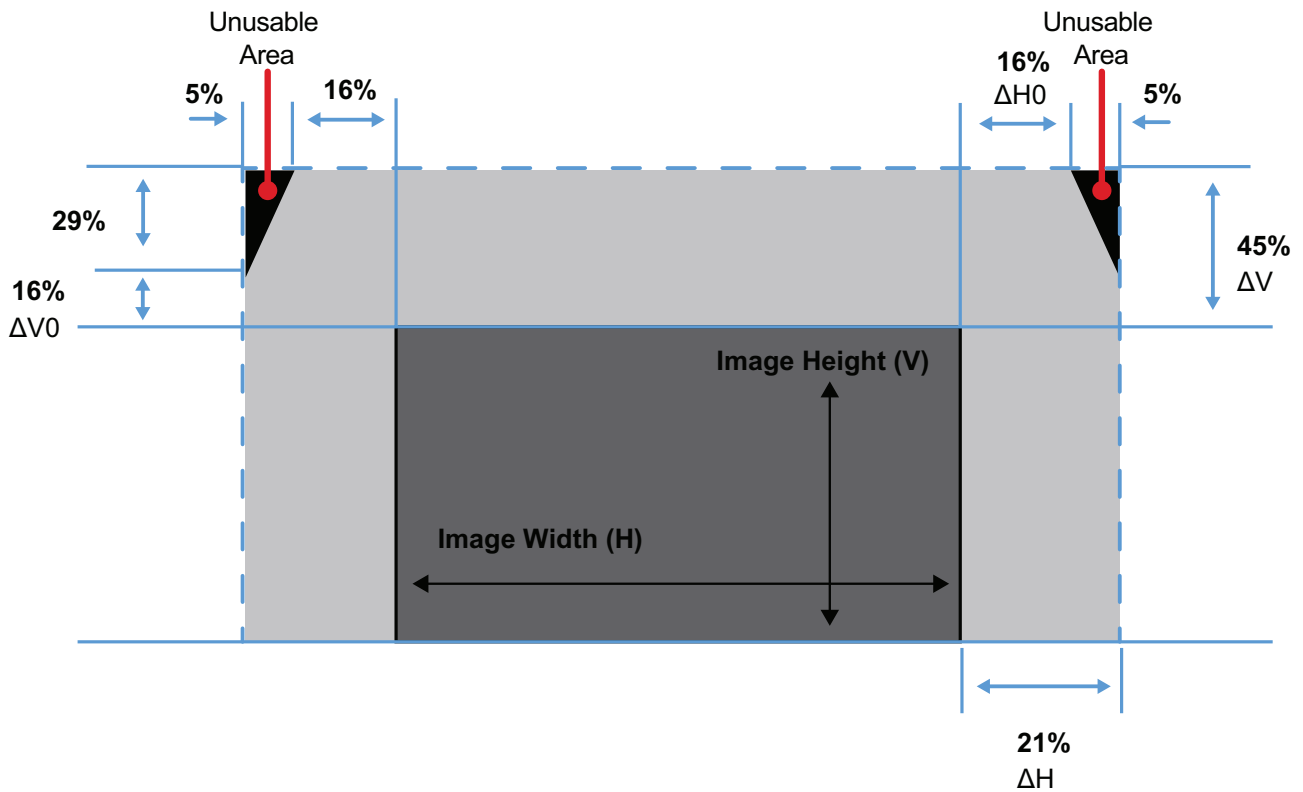

NOTE:

- V : Projected image height.
- H : Projected image width.
- ΔH : Maximum horizontal shift when the lens is centered.
- ΔH_0 : The lens shift range without vignetting in horizontal direction when the lens is at the top center or the bottom center.
- ΔV : Maximum vertical shift when the lens is centered.
- ΔV_0 : The horizontal lens shift range that avoids vignetting when the lens is positioned at the top center or bottom center.
- When the lens is shifted beyond the described range of operation, screen edges may become darker or images may become out of focus.
- The calculation is based on image width and image height.

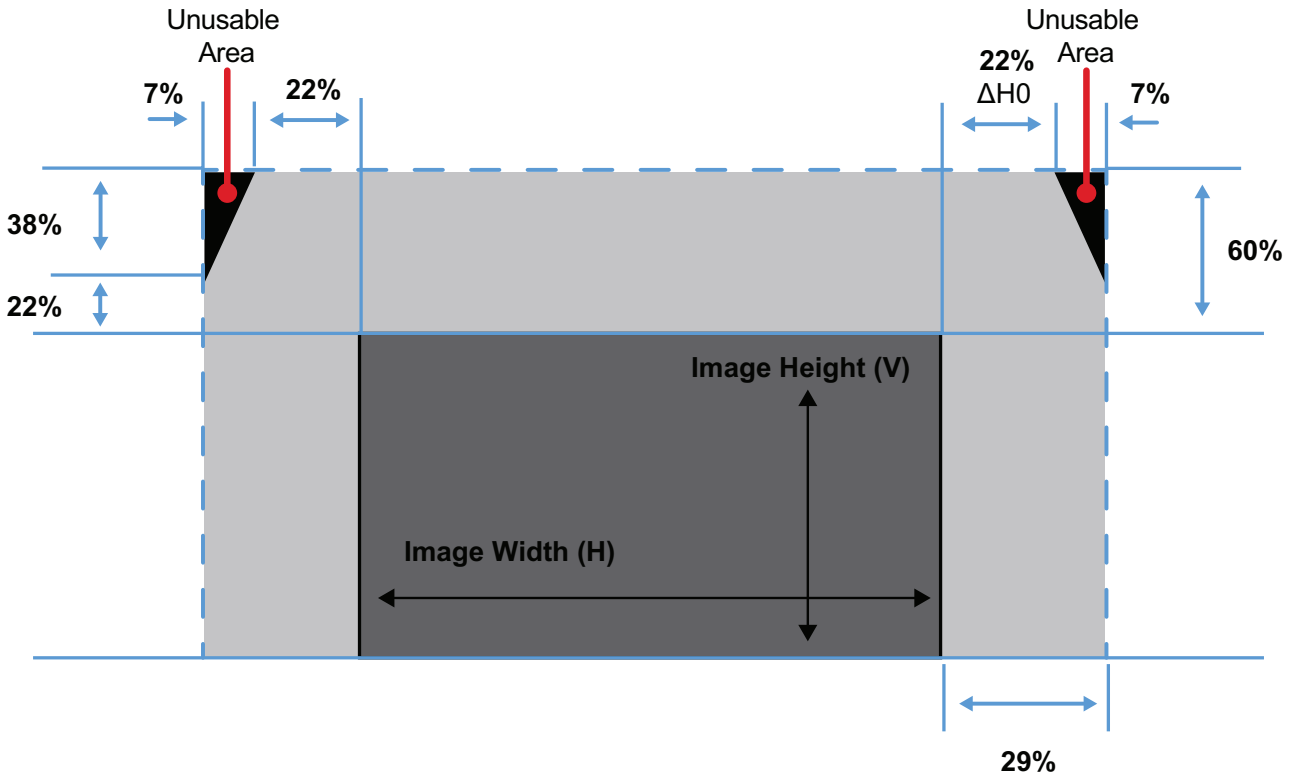

NOTE:

- V : Projected image height.
- H : Projected image width.
- ΔH : Maximum horizontal shift when the lens is centered.
- ΔH0 : The lens shift range without vignetting in horizontal direction when the lens is at the top center or the bottom center.
- ΔV : Maximum vertical shift when the lens is centered.
- ΔV0: The horizontal lens shift range that avoids vignetting when the lens is positioned at the top center or bottom center.
- When the lens is shifted beyond the described range of operation, screen edges may become darker or images may become out of focus.
- The calculation is based on image width and image height.

LSC600-4K | LSC601-4K | LSC700-4K | LSC701-4K

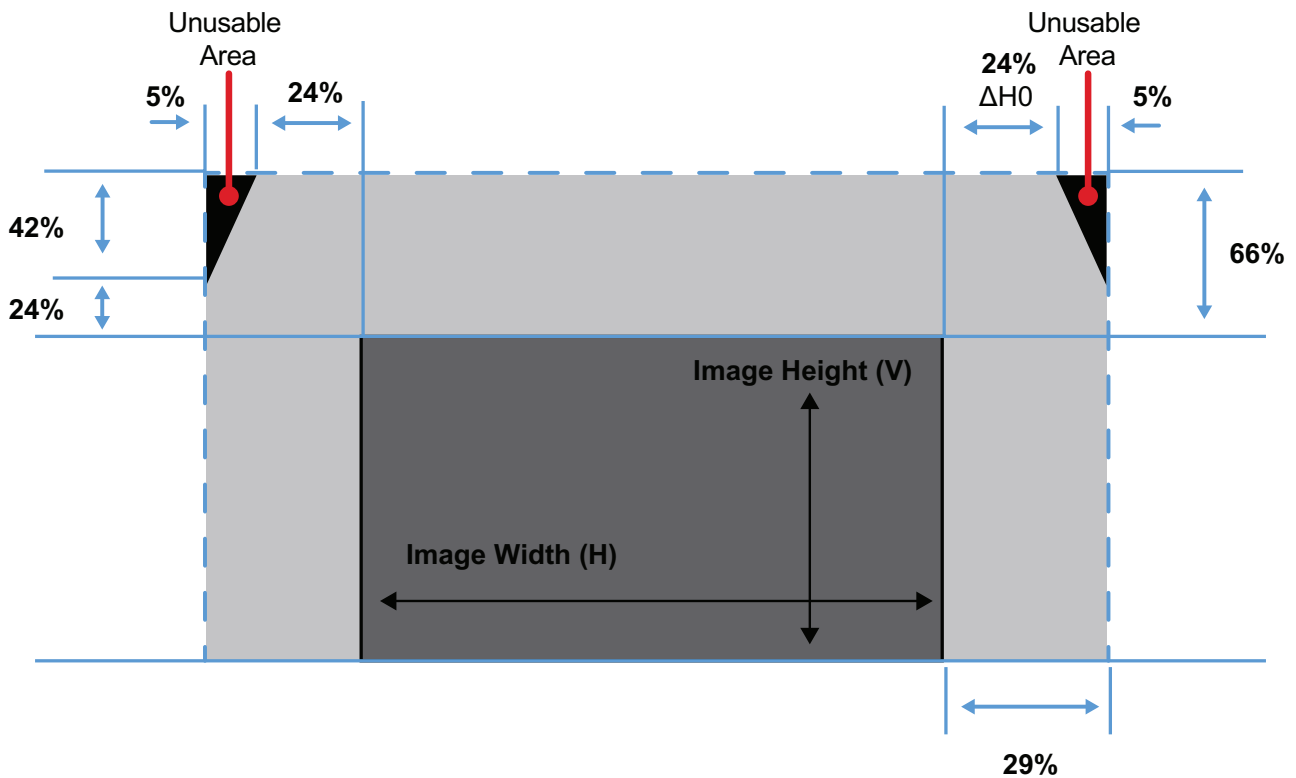

NOTE:

- V : Projected image height.
- H : Projected image width.
- ΔH : Maximum horizontal shift when the lens is centered.
- ΔH0 : The lens shift range without vignetting in horizontal direction when the lens is at the top center or the bottom center.
- ΔV : Maximum vertical shift when the lens is centered.
- ΔV0: The horizontal lens shift range that avoids vignetting when the lens is positioned at the top center or bottom center.
- When the lens is shifted beyond the described range of operation, screen edges may become darker or images may become out of focus.
- The calculation is based on image width and image height.

LSC730WU-ST | LSC731WU-ST

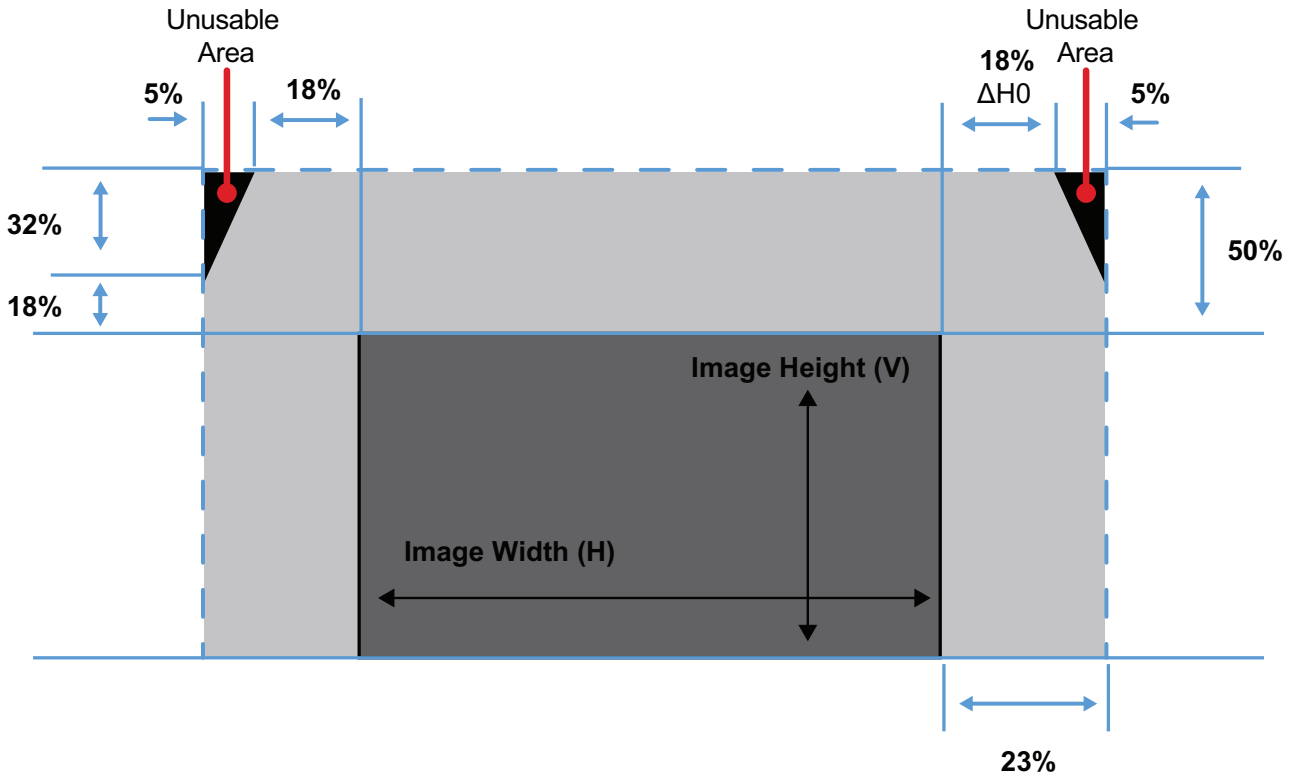

NOTE:

- V : Projected image height.
- H : Projected image width.
- ΔH : Maximum horizontal shift when the lens is centered.
- $\Delta H0$: The lens shift range without vignetting in horizontal direction when the lens is at the top center or the bottom center.
- ΔV : Maximum vertical shift when the lens is centered.
- $\Delta V0$: The horizontal lens shift range that avoids vignetting when the lens is positioned at the top center or bottom center.
- When the lens is shifted beyond the described range of operation, screen edges may become darker or images may become out of focus.
- The calculation is based on image width and image height.

Turning the Projector Off





1. Press the **Power** button on the projector or remote control and a “power off message” will appear.
2. Press the **Power** button again to confirm and put the projector in standby mode.

Menu Operation (non 4K models¹)

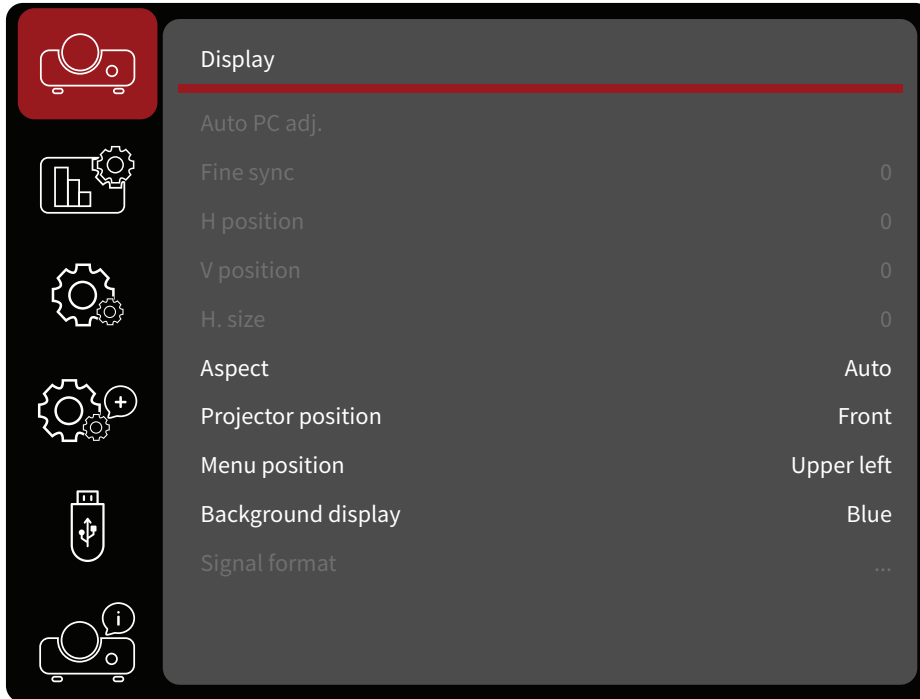
On-Screen Display (OSD) Menu

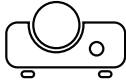
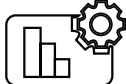
The projector has multilingual on-screen display menus that allow you to make image adjustments and change a variety of settings.

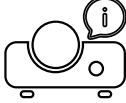

Menu		Description
Display		Adjust image position, Aspect, Projector and Menu Position, Background Display, and Signal Format settings.
Image Settings		Adjust Image Mode, Contrast, Brightness, and other image settings.
Settings		Adjust Direct Power On, Standby Mode, High Altitude Mode, Cooling Fast, Key Lock, Contrast Optimization, Baud Rate, Laser Control, Sound, and HDMI Setup.
Advanced		Adjust Language, Auto Setup, Keystone, Logo, Security, Power Management, Filter, Test Pattern, and Network Setup settings.
USB A		Adjust slide, transition, slide order, and other settings when a USB Type A storage device is connected to the projector.
Information		View projector information.

1 - This includes the following models: LSC600W-ST, LSC601W-ST, LSC600WU-ST, LSC601WU-ST, LSC730WU-ST, LSC731WU-ST, LSC600WU, LSC601WU, LSC650WU, LSC651WU, LSC730WU, LSC731WU, LSC800WU, and LSC801WU.

Menu Navigation

The projector has multilingual on-screen display menus that allow for image and settings adjustment.

1. To open the On-Screen Display (OSD) Menu, press the **Menu** button on the projector or the remote control.
2. When the OSD is displayed, use the **Navigation** buttons (**▲/▼**) to select any item in the main menu. While making a selection on a particular page, press the **OK** button on the projector or the remote control to enter a sub-menu.
3. Use the **Navigation** buttons (**▲/▼/◀/▶**) to select the desired item in the sub-menu and then press **OK** to view further settings. Adjust the settings by using the **Navigation** buttons (**▲/▼/◀/▶**).
4. Select the next item to be adjusted in the sub-menu and adjust as described above.
5. Press **OK** to confirm, and the screen will return to the main menu.
6. To exit, press the **Menu** button again. The OSD menu will close and the projector will automatically save the new settings.

On-Screen Display (OSD) Menu Tree

Main Menu	Sub-menu	Menu Option	
Display	Auto PC Adj.		
	Fine Sync	(0~31)	
	H Position	(-5~+5)	
	V Position	(-5~+5)	
	H Size	(-15~+15)	
	Aspect	Auto	
		16:9	
		21:9	
		16:10	
		4:3	
	Projector Position	Front	
		Rear	
		Ceiling / Front	
		Ceiling / Rear	
		Auto Ceiling / Front	
		Auto Ceiling / Rear	
	Menu Position	Upper Left	
		Upper Right	
		Center	
		Lower Left	
		Lower Right	
	Background Display	Black	
		Blue	
Signal Format			

Main Menu	Sub-menu	Menu Option		
Image Settings	Image Mode	Standard		
		Cinema		
		Golf		
		Colorboard		Red
				Blue
				Green
				Yellow
	User			
	Brightest			
	Contrast		(0~63)	
	Brightness		(0~63)	
	Color Temp		High	
			Mid	
			Low	
			User	
	Red		(0~63)	
	Green		(0~63)	
	Blue		(0~63)	
Sharpness	(0~15)			
Advanced Color Adj.	Hue/Saturation/Gain		Red	
			Yellow	
			Green	
			Cyan	
			Blue	
			Magenta	
		Reset		
Settings	Direct Power On	On		
		Off		
	Standby Mode	Normal		
		ECO		
		Network		
	High Altitude Mode	Auto		
		On		
		Off		

Main Menu	Sub-menu	Menu Option		
Settings	Cooling Fast	Normal		
		0 sec		
		30 sec		
	Key Lock	On		
		Off		
	Contrast Optimization	On		
		Off		
	Baud Rate	19200		
		4800		
		38400		
		9600		
	Laser Control	Light Source Mode		Normal
				Full Normal
				ECO1
				ECO2
		Laser Adjust		50~100%
	Sound	Volume		(0~25)
Mute		On		
		Off		

Main Menu	Sub-menu	Menu Option		
Settings	Edge Blending ²	Edge Blending	On	
			Off	
		Area Setting	Boundary Line	On
				Off
			Left	On
				Off
			Top	On
				Off
			Right	On
				Off
			Bottom	On
				Off
			Left Range	20%
			Top Range	20%
		Right Range	20%	
		Bottom Range	20%	
		White Balance	R Gain	(0~64)
			G Gain	(0~64)
			B Gain	(0~64)
			R Offset	(0~64)
			G Offset	(0~64)
B Offset	(0~64)			
Reset				

² - Only for LSC730WU-ST, LSC731WU-ST, LSC730WU, LSC731WU, LSC800WU, and LSC801WU.

Main Menu	Sub-menu	Menu Option		
Settings	Edge Blending	Blending Area	Top	
			Bottom	
			Left	
			Right	
			Other Area	
		Image Edge Adj.	Level	Level 0
				Level 1
				Level 2
				Level 3
				Level 4
				Level 5
			Red	(0~255)
			Green	(0~255)
			Blue	(0~255)
			Gain	(0~5)
			Reset	
		EB Keystone	EB 4 Dot Keystone	
			Grid Image Tune	
			Reset	
		Advanced	H Total	(1~4)
	Position H		(1~4)	
	H Range 1		20%	
	H Range 2		20%	
	H Range 3		20%	
	HDMI Setup	Image	Auto	
			(64~940)	
			(0~1023)	
Sound		HDMI		
	Computer			

Main Menu	Sub-menu	Menu Option	
Advanced	Language	English Deutsch Français Italiano Español Português Nederlands Svenska Suomi Norsk Dansk Polski Český Magyar Русский Türkçe Қазақ Tiếng Việt 한국어 日本語 ไทย 中文繁體 中文 Bahasa Indonesia	
	Auto Setup	Input Search	On
			Off
		Auto PC Adj.	On
			Off
		Auto Keystone	On
			Off
	Keystone	Keystone	Reset
			Store
		H/V Keystone	
		4-Corner Correction	
		6-Corner Correction (WUXGA only)	
		Curved Correction (WUXGA only)	
		Grid Image Tune (WUXGA only)	
	Reset Value		

Main Menu	Sub-menu	Menu Option		
Advanced	Logo	Logo Select	Off	
			Default	
			User	
		Capture		
		Logo PIN Code Lock	On	
			Off	
	Logo PIN Code Change			
	Security	PIN Code Lock	On	
			Off	
		PIN Code Change	PIN Code	Set
				Cancel
	Power Management	Ready		
		Shutdown		
		Off		
		Timer	(1~30 min)	
		Ready Countdown	(0~30 min)	
	Filter Counter	Timer	Off	
			500H	
			1000H	
			2000H	
		Filter Counter Reset		

Main Menu	Sub-menu	Menu Option		
Advanced	Test Pattern	Off		
		Gray scale 1		
		Gray scale 2		
		Gray scale 3		
		Gray scale 4		
		Color bar		
		Red		
		Green		
		Blue		
		Cross hatch		
		White		
		Black		
		Raster gray		
		ViewSonic		
	Network Setup	Network Setting	LAN	DHCP
				IP Address
		Subnet		
		Gateway		
		DNS		
		Network Information		
Factory Default	Return to Factory Default?	Yes		
		No		

Main Menu	Sub-menu	Menu Option
USB-A	Set Slide	
	Slide Transition Effect	Slide Down
		Slide Right
	Sort Order	Extend Order
		Name Order
		Timer Order
		Size Order
	Rotate	No Rotate
		270 Degrees
		180 Degrees
		90 Degrees
	Best Fit	On
		Off
	Repeat	On
Off		
Apply		
Information	Input	
	H-Sync Freq.	
	V-Sync Freq.	
	Light Source Counter	
	Image Mode	
	MAC Address	
	S/N	
	Firmware Version	
	SUBCPU	

Menu Options

Display

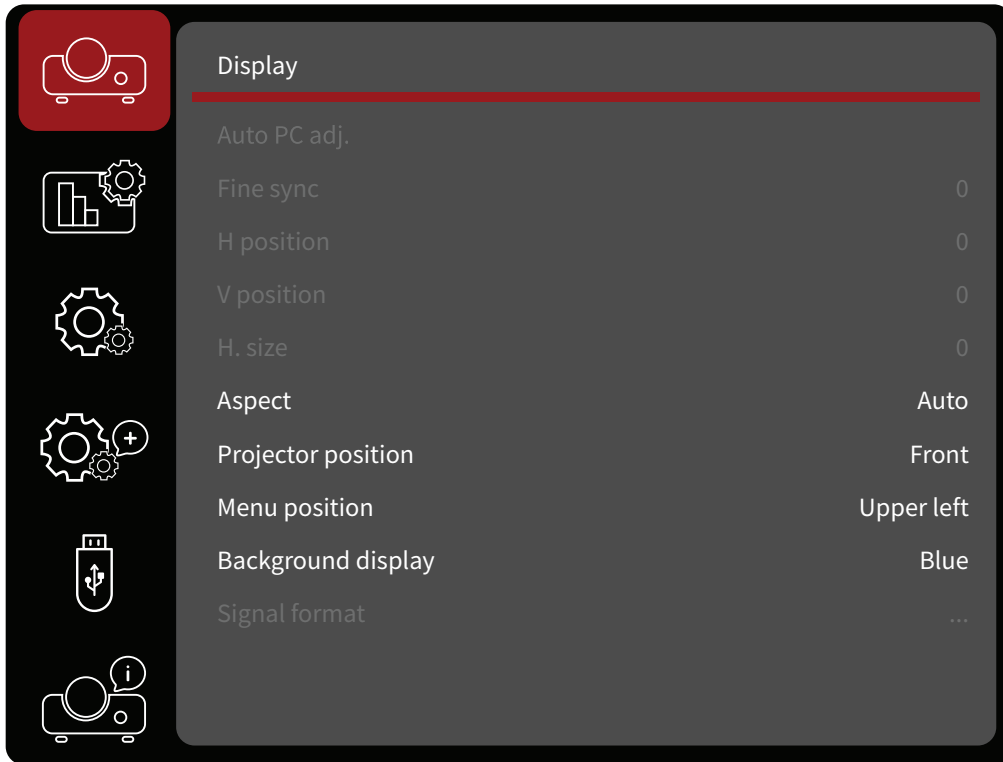

Menu	Description
Auto PC Adj.	Automatically adjust the best picture timings for the projected image. NOTE: For the PC input signal only.
Fine Sync	Manually adjust the picture timings for the projected image. NOTE: For the PC input signal only.
H Position	Manually set the horizontal position of the projected image. NOTE: <ul style="list-style-type: none"> For the PC input signal only. The adjustment range may vary depending on the display timings.
V Position	Manually set the vertical position of the projected image. NOTE: <ul style="list-style-type: none"> For the PC input signal only. The adjustment range may vary depending on the display timings.
H. Size	Manually set the horizontal width of the projected image. NOTE: For the PC input signal only.

Menu	Description	
Aspect	Auto	Scales an image proportionally to fit the projector's native resolution in its horizontal width. This is suitable for the incoming image which is neither in 4:3 nor 16:9 and you want to make most use of the screen without altering the image's aspect ratio.
	16:9	Scales an image so that it is displayed in the center of the screen with a 16:9 aspect ratio. This is most suitable for images which are already in a 16:9 aspect, like high definition TV, as it displays them without aspect alteration.
	21:9	Scales an image for a MTR application.
	16:10	Scales an image so that it is displayed in the center of the screen with a 16:10 aspect ratio. This is most suitable for images which are already in a 16:10 aspect, as it displays them without aspect alteration.
	4:3	Scales an image so that it is displayed in the center of the screen with a 4:3 aspect ratio. This is most suitable for 4:3 images like computer monitors, standard definition TV, and 4:3 aspect DVD movies, as it displays them without aspect alteration.
Projector Position	Select the projection position of the projector.	
Menu Position	Set the On-Screen Display (OSD) Menu's position on screen.	
Background Display	Set the background color.	
Signal Format³	Set the projection area's display color.	

³ - Not available for USB reader, USB display, or LAN display.

Image Settings

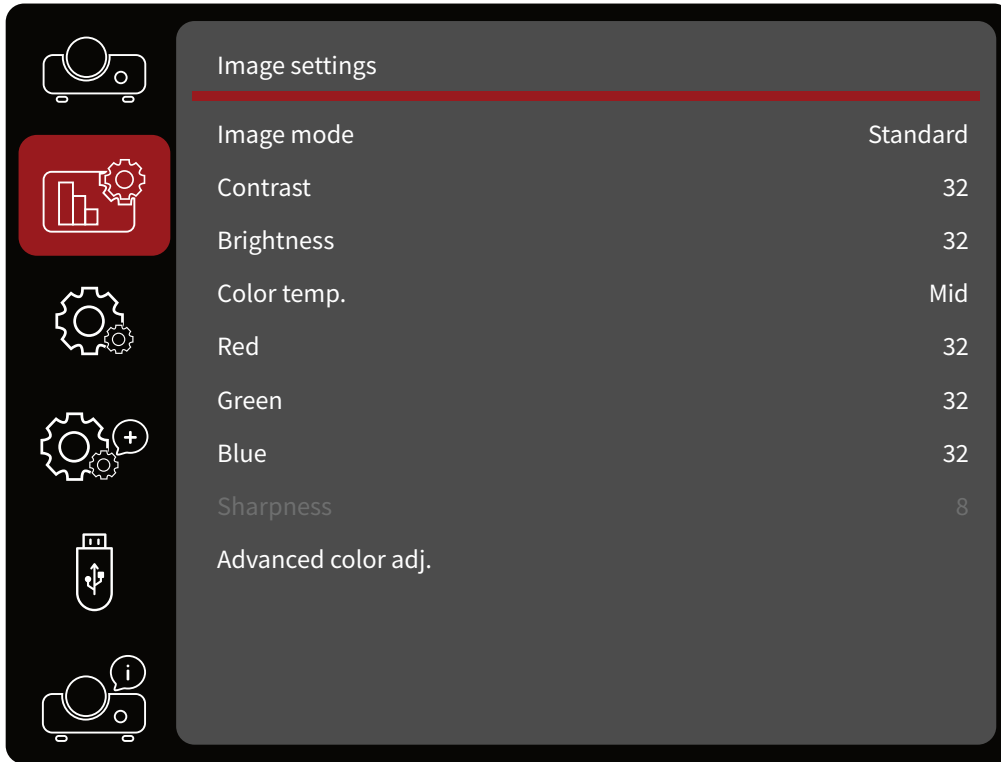

Menu	Description	
Image Mode	There are several predefined display modes that you can choose from to suit your viewing preference.	
	Standard	Designed for normal circumstances in a daylight environment.
	Cinema	Provides the best balance of detail and colors for watching movies.
	Golf	Suitable for golf simulators.
	Colorboard	Designed for environments with different wall colors.
	User	User-specific, custom image settings.
	Brightest	Suitable for bright, well-lit environments.
Contrast	Use this to set the peak white level after you have previously adjusted the Brightness setting to suit your selected input and viewing environment.	
Brightness	The higher the value, the brighter the image. Lower values will result in a darker image.	
Color Temp.	High/Mid/Low	Select from Warm, Standard, or Cold color temperatures.
	User	Set a custom color temperature.
Red	Adjusts the contrast levels of red.	
Green	Adjusts the contrast levels of green.	

Menu	Description
Blue	Adjusts the contrast levels of blue.
Sharpness	A higher value will sharpen the image, while a lower value will soften the image.
Advanced Color Adj.⁴	Only in permanent installations with controlled lighting levels such as boardrooms, lecture theaters should advanced color adjustment be considered. Advanced color adjustment provides fine color control adjustment to allow for more accurate color reproduction. Select the primary color first and adjust its range/values in hue, saturation, and gain.

4 - Not available for LSC600W-ST and LSC601W-ST.

Settings

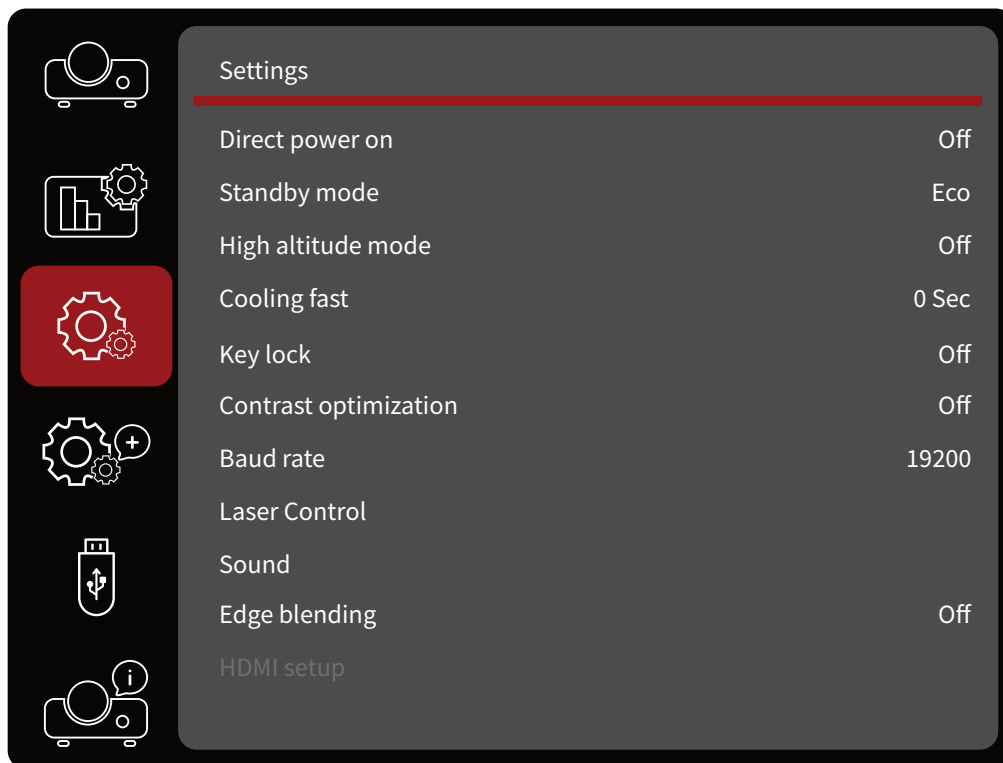

Menu	Description	
Direct Power On	The projector will turn on automatically once connected to a power source.	
Standby Mode	Normal	Normal standby > 0.5W; the Network setup function is available.
	Eco	Eco standby < 0.5W; the Network setup function is not available.
	Network	Network standby; only available Wake on LAN (WOL).
High Altitude Mode	When turned on, the fans will spin faster for better cooling and performance. This is useful for high altitude environments where the air is thin. If set to Auto , the projector will activate the high-altitude mode automatically.	
Cooling Fast	Select the cooling fan speed to shorten the cooling time.	
Key Lock	Lock and unlock the control panel.	
Contrast Optimization	Select this function to automatically optimize and adjust the signal based on the image, providing dynamic contrast for the best possible visual clarity and depth.	

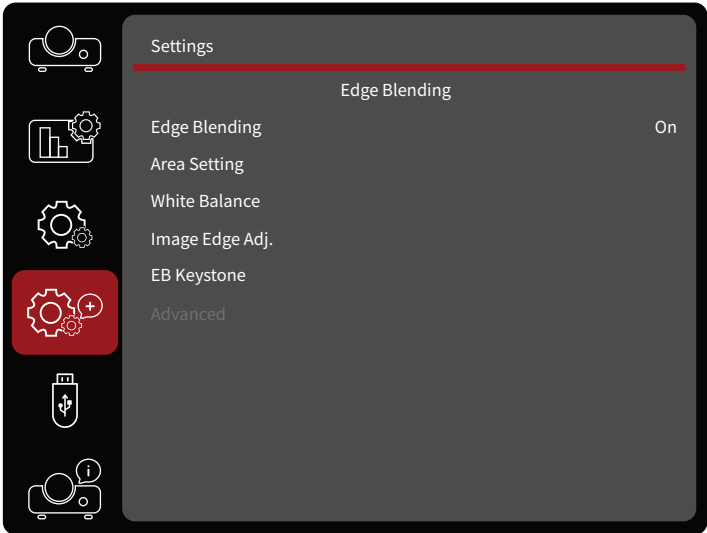
Menu	Description	
Baud Rate	Set a baud rate that is identical with your computer's so that you can connect the projector using a suitable RS-232 cable and control the projector with RS-232 commands.	
Laser Control	Change the light source brightness according to the projector's operating environment.	
	Normal	Adjustable brightness level, 50%~100%.
	Full	Non-adjustable brightness level, 100%.
	ECO1	60% brightness level.
	ECO2	50% brightness level.
Sound	Volume	Decrease or increase the sound level.
	Mute	Turn off or turn on the sound.
Edge Blending	<p>The Edge Blending function supports blending up to four projector screens of the same model. Mixing different projector models is not recommended. This function can horizontally split input content into a maximum of four parts, but it cannot split input content vertically. Please use an HDMI splitter to send the same input content to all blending projectors.</p> <p>NOTE:</p> <ul style="list-style-type: none"> • Edge Blending does not support VGA input. • Adjusting Edge Blending will reset all existing horizontal and vertical Keystone adjustments. 	
	 <p>The screenshot shows a dark grey settings menu with a red horizontal line at the top. The menu items are: Settings, Edge Blending (with 'On' to its right), Area Setting, White Balance, Image Edge Adj., EB Keystone, and Advanced. The 'Edge Blending' item is highlighted with a red background and a white gear icon.</p>	
	Area Setting	Set the range of the blending area.
White Balance	Adjust the Red / Green / Blue color brightness and saturation of the blended image, bringing the colors closer together	

Menu	Description		
Edge Blending	Image Edge Adj.	Adjust the blending effect smoothly by switching between the Left, Right, Top, Bottom, and Non-Blending areas.	
		Level 0	Adjust brightness of blending area to 0%.
		Level 1	Adjust brightness of blending area to 25%.
		Level 2	Adjust brightness of blending area to 50%.
		Level 3	Adjust brightness of blending area to 75%.
		Level 4	Adjust brightness of blending area to 100%.
		Level 5	Adjust brightness of non-blending area to 0%.
	EB Keystone	<p>Set 4 corner adjustment and grid image adjustment.</p> <p>Use the EB Keystone feature to precisely adjust the blending area between projectors. There are two OSD tools available: EB 4Dot Keystone and Grid Image Tune.</p> <p>The 4Dot Keystone tool adjusts the four corners of the full screen, while the Grid Image Tune tool allows for detailed position adjustments.</p>	
	Advanced	Set projector quantity, projector position and blending range.	

Menu	Description		
HDMI Setup	Image	Auto	Automatically set to standard signal.
		64~940	Manually adjust the signal until the image is normal.
		0~1023	Manually adjust the signal until the image is normal.
	Sound	HDMI	Output audio from the device connected to the HDMI port.
		Computer	Output audio from the device connected to the COMPUTER port.
	HDMI EQ Settings	0/1/2/3	Adjust the HDMI input signal level according to the device connected to the HDMI port. If there is a lot of noise in the image, or problems such as the inability to project the image occur, the settings must be changed.

Advanced

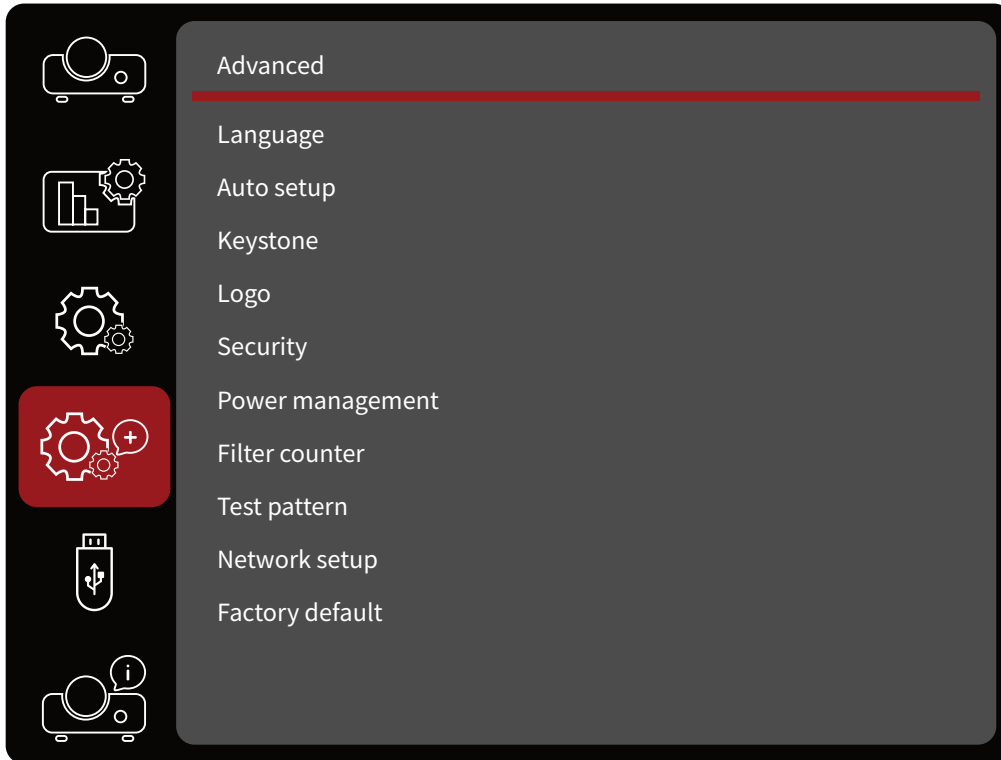

Menu	Description	
Language	Select the On-Screen Display (OSD) Menu language.	
Auto Setup	Input Search	Automatically find and project an available input source.
	Auto PC Adj.	When Auto PC Adj. is turned on, the projector will input an analog signal. Pressing the Auto button on the remote control will adjust Fine Sync, H. Position, V. Position, and H. Size automatically. When Auto PC Adj. is turned off, the Auto button on the remote control will be unsupported.
	Auto Keystone	Automatically correct a distorted projected image.

Menu	Description	
Keystone	Keystone	Store or reset the keystone correction after unplugging the power cord.
	H/V Keystone	Correct the projected image horizontally or vertically.
	4-Corner Correction	Correct the projected image's four corners.
	6-Corner Correction	Correct the projected images' six corners.
	Curved Correction	Correct a projected image that is uneven or deformed due to a curved surface.
	Grid Image Tune	Adjust the local points of the projected image.
	Reset	Return the settings to their default values.
Logo	Logo Select	Set the startup logo when powering on the projector.
	Capture	Capture images being projected and use it for a startup logo.
	Logo PIN Code Lock	Prevent unauthorized personnel from changing the logo screen.
	Logo PIN Code Change	Change the PIN code to any 3-digit number.
Security	PIN Code Lock	Prevent unauthorized personnel from operating the projector.
	PIN Code Change	Change the PIN code to any 3-digit number.

Menu	Description	
<p style="text-align: center;">Power Management</p>	Ready	<p>A countdown will be displayed after 30 seconds without a signal input.</p> <p>Allows the projector to enable Ready mode automatically after a set period of time once no input source is detected .</p> <p>If the input signal is reconnected or any key (except the Power button) on the remote control or control panel is pressed, the light source will be turn back on.</p>
	Shutdown	<p>A countdown will be displayed after 30 seconds without a signal input.</p> <p>Allows the projector to shut down automatically after a set period of time once no input source is detected to prevent unnecessary waste of light source life.</p>
	Off	Disable the power management function.
	Timer	Sets period of time once no input source is detected and allows the projector to turn Ready mode automatically.
	Ready Countdown	<p>When Power Management is set to Ready, the transition time from Ready mode to standby mode is 0 to 30 minutes.</p> <p>If set to 0, the projector can not switch automatically. In Ready mode, press the Power button to switch the projector from Ready mode to Standby mode and press any other key to power on the projector.</p>
<p style="text-align: center;">Filter Counter</p>	<p>The filter prevents dust from entering your projector, which can build up on internal parts. A blocked filter may reduce the cooling fan's efficiency, causing the projector to overheat and potentially shorten its lifespan. Clean the filter promptly whenever the Filter Warning icon appears.</p> <p>Please follow these steps to clean your filter:</p> <ol style="list-style-type: none"> 1. Turn off the projector and unplug it from its power source. 2. Remove the filter. 3. Gently clean it with a brush. 4. Replace the filter, making sure it has been inserted fully. 	
	Filter Counter	Display the filter's usage time.
	Timer	Set the filter's cleaning time.
	Filter Counter Reset	Reset the Filter Counter.

Menu	Description
Test Pattern	Display the projector's built-in test pattern. NOTE: Not available for USB A, USB B, and LAN display.
Network Setup	Set the IP address, LAN, and DHCP settings. NOTE: The projector does not support wireless display. Users can purchase a Wi-Fi dongle with a built-in RTL8192EU driver.
Factory Default	Returns all settings to the factory preset values. NOTE: When using Reset Settings, the following settings will still remain: Language, Projector Projection, Baud Rate, High Altitude, and Light Source Hours.

Controlling the Projector through a Network

The projector provides diverse networking and remote management features. The LAN /RJ45 function of the projector, through a network, can remotely manage: Power On/Off, Volume adjustment, Input select, Brightness, and more.

1. Connect the projector to a network via the LAN/RJ45 port.
2. Open the On-Screen Display Menu and go to: **Advanced > Network Setup**.
3. Select **DHCP** and turn it **On** to obtain an IP address automatically; or select **Off** to enter the network information manually.

NOTE: Please wait for around 15~20 seconds, then re-enter the **Network Setup** settings page. The Projector IP Address, Subnet Mask, Default Gateway, DNS Server settings will be displayed. Make note of the IP address displayed in the Projector IP Address row.

4. Using a web browser, and under the same network, type in the projector's IP address.
5. Enter the user name and password, then click **Log in**.

USB-A

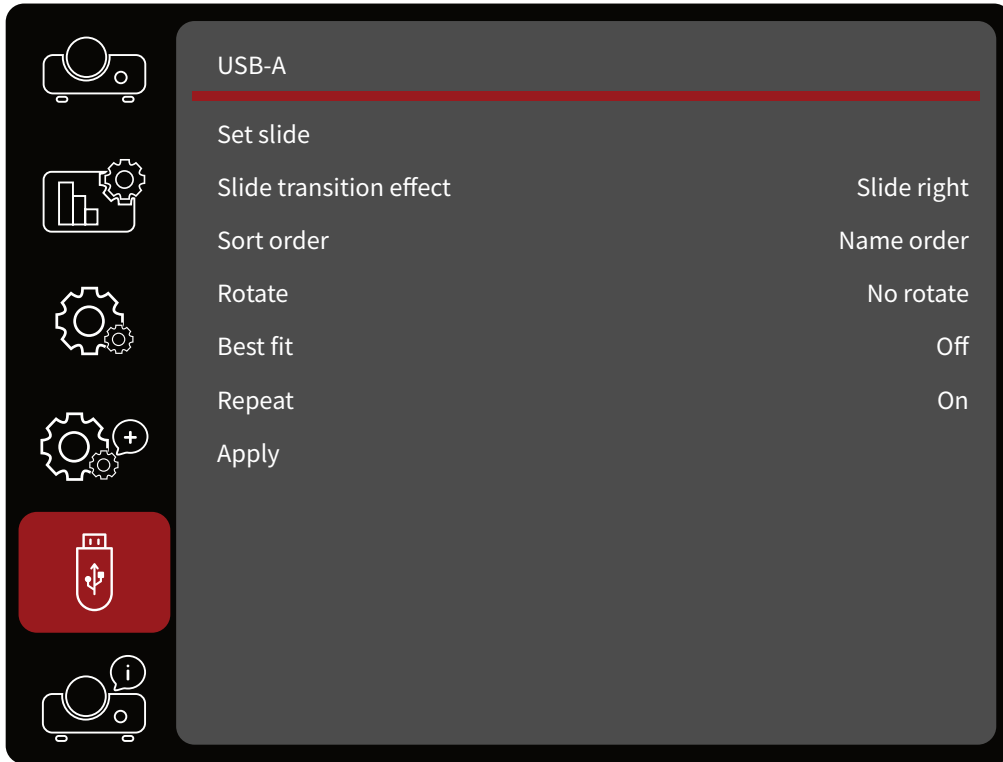

Menu	Description
Set Slide	Display slides.
Slide Transition Effect	Control slide playback transition effects.
Sort Order	Set the order of the slides.
Rotate	Set the rotation direction of images.
Best Fit	Set the image to fit with the projection screen.
Repeat	Play the slides repeatedly when turned on.
Apply	Enable the slide settings.

Supported File Formats

Video

Extension	Video Codec	Audio Codec	Video Format
.avi	MotionJPEG	ADPCM	1280 x 70, 30 FPS (Maximum)

Image

Extension	Format	Description
jpg/jpeg	Baseline encoder 24 Progressive RGB24 bit	Maximum Resolution: 10000 x 10000
		Maximum Resolution: Panel resolution
bmp	1.4.8 bit palette-based RGB24, 32-bit	Maximum Resolution: 1280 x 800
png	24, 48-bit True Color	-24-bit color palette space
		Maximum Resolution: 1024 x 768
gif	1, 4, 8-bit palette-based	Maximum Resolution: 800 x 600
tiff		Maximum Resolution: 800 x 600

Information

View Input source, H-Sync Freq., V-Sync Freq., Light Source Counter, Image Mode, MAC Address, Serial Number, Firmware Version, and SUBCPU information.

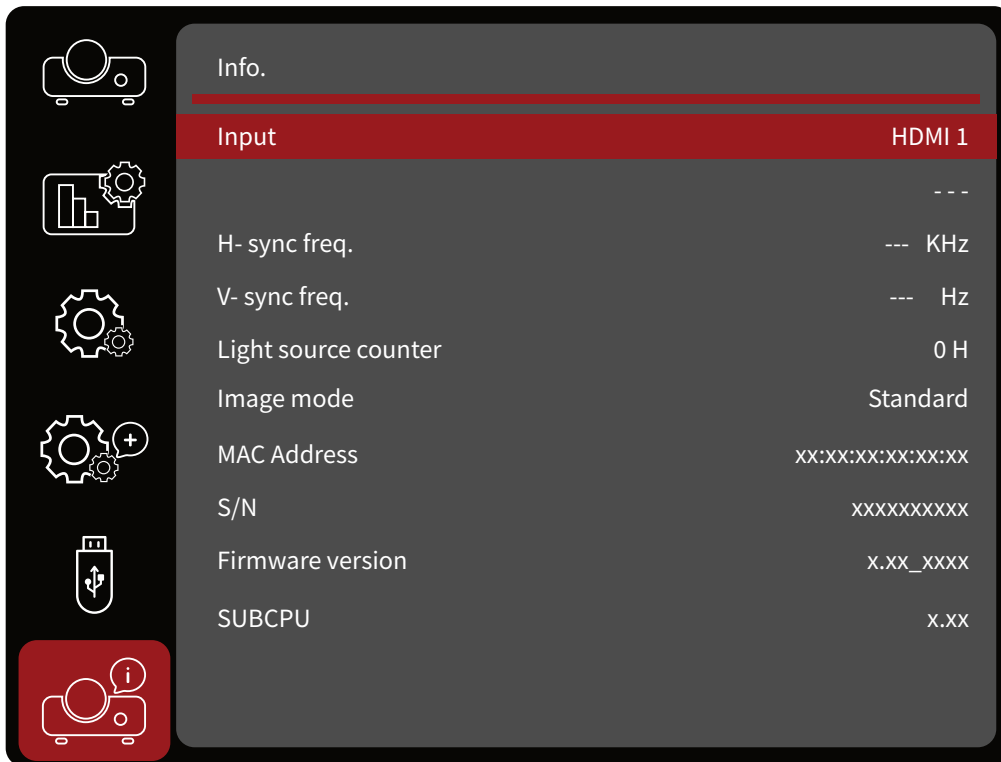

Menu Operation (4K models¹)

On-Screen Display (OSD) Menu

The projector has multilingual on-screen display menus that allow you to make image adjustments and change a variety of settings.

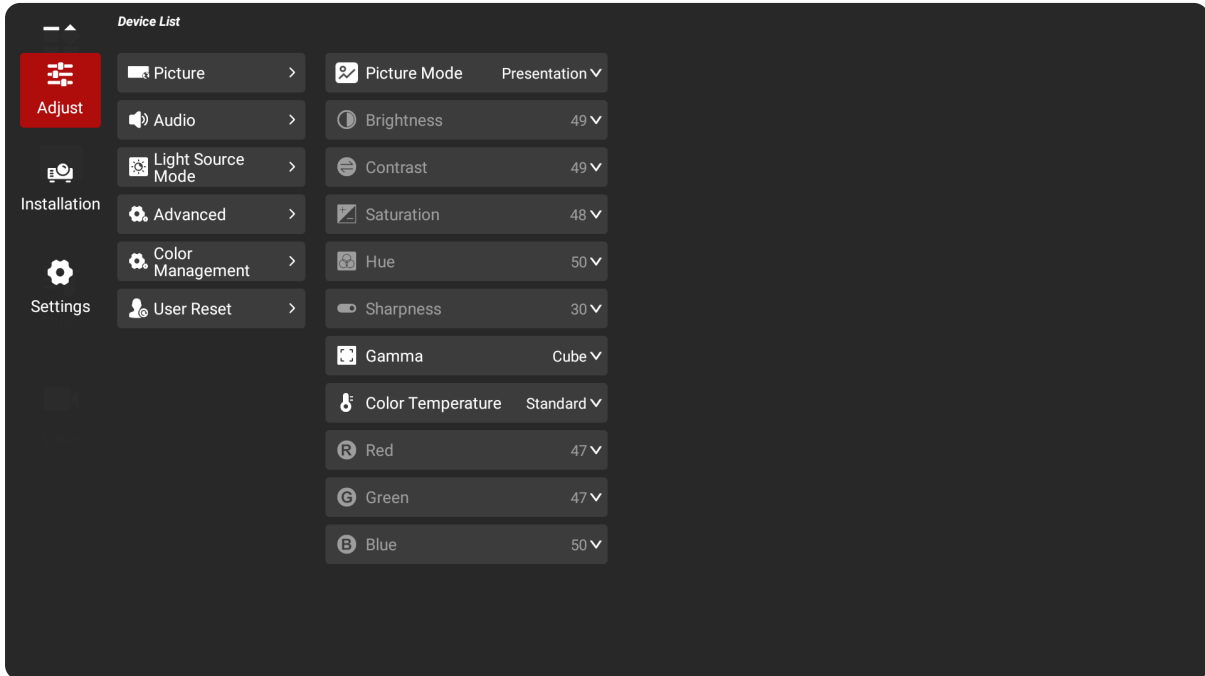

Menu		Description
Adjust		Adjust Picture, Audio, Light Source Mode, Advanced, Color Management, and User settings.
Installation		Adjust Projector Projection, Geometric Correction, Filter, High Altitude Mode, and Digital Lens Shift settings.
Settings		Adjust Language, Wired LAN, Power Management, HDMI, Information, Firmware, and Factory Reset settings.

1- This includes the following models: LSC600-4K, LSC601-4K, LSC700-4K, and LSC701-4K.

Menu Navigation

The projector has multilingual on-screen display menus that allow for image and settings adjustment.

1. To open the On-Screen Display (OSD) Menu, press the **Menu** button on the projector or the remote control.
2. When the OSD is displayed, use the **Navigation** buttons (**▲/▼**) to select any item in the main menu. While making a selection on a particular page, press the **OK** button on the projector or the remote control to enter a sub-menu.
3. Use the **Navigation** buttons (**▲/▼/◀/▶**) to select the desired item in the sub-menu and then press **OK** to view further settings. Adjust the settings by using the **Navigation** buttons (**▲/▼/◀/▶**).
4. Select the next item to be adjusted in the sub-menu and adjust as described above.
5. Press **OK** to confirm, and the screen will return to the main menu.
6. To exit, press the **Menu** button again. The OSD menu will close and the projector will automatically save the new settings.

On-Screen Display (OSD) Menu Tree

Main Menu	Sub-menu	Menu Option	
Adjust	Picture	Picture Mode	Brightest
			Presentation
			Movie
			Golf
			Game
			HDR
			User
		Brightness	(0~100)
		Contrast	(0~100)
		Saturation	(0~100)
		Hue	(0~100)
		Sharpness	(0~100)
		Gamma	1.8
			2.0
			2.2
			2.4
		Color Temperature	Standard
			Warm
			Cool
			User
	Red	(0~100)	
	Green	(0~100)	
	Blue	(0~100)	
	Audio	Volume	(0~100)
		S/PDIF	Off
			On
	Light Source Mode	Normal	
ECO			
Adjust		50~100%	

Main Menu	Sub-menu	Menu Option		
Adjust	Aspect Ratio	Auto		
		Full		
		4:3		
		16:9		
		16:10		
		21:9		
	Magnify	Zoom	(0~100)	
		Positions	Enter	
	Advanced	HDMI Range	Auto	
			Full	
			Limited	
		HDMI EDID	Enhanced	
			Normal	
		DCR	Off	
	On			
	Color Management	Hue	R	(0~63)
			Y	(0~63)
			G	(0~63)
			C	(0~63)
			B	(0~63)
			M	(0~63)
		Saturation	R	(0~63)
			Y	(0~63)
			G	(0~63)
C			(0~63)	
B			(0~63)	
M			(0~63)	
Gain		R	(0~31)	
		Y	(0~31)	
		G	(0~31)	
		C	(0~31)	
		B	(0~31)	
		M	(0~31)	
Adjust	User Reset	Are you sure you want to reset your projector?		
		OK	Cancel	

Main Menu	Sub-menu	Menu Option		
Installation	Projector Projection	Front Table		
		Rear Table		
		Front Ceiling		
		Rear Ceiling		
		Auto Front Ceiling		
		Auto Rear Ceiling		
	Geometric Correction	Keystone	Auto	
			Manual	
			H Keystone	
			V Keystone	
		4 Corner		
	Filter Settings	Filter Hours	200 Hours	
			500 Hours	
			1000 Hours	
			3000 Hours	
			Custom	
		Warning Message	On	
			Off	
	High Altitude Mode	Used Time	Reset	
		Off		
Auto				
Digital Lens Shift	On			
	(-60~60)			

Main Menu	Sub-menu	Menu Option	
Settings	Language	English	
		German	
		French	
		Italian	
		Spanish	
		Polish	
		Swedish	
		Dutch	
		Portuguese	
		Japanese	
		Simplified Chinese	
		Traditional Chinese	
		Korean	
		Russian	
		Turkish	
		Finnish	
		Norwegian	
		Danish	
		Indonesian	
		Hungarian	
	Czech		
	Vietnamese		
	Thai		
	Wired LAN	DHCP	Auto
			Static IP
		IP Address	
		Subnet Mask	
Default Gateway			
DNS Server			
Apply			

Main Menu	Sub-menu	Menu Option	
Settings	Power Management	Power On Mode	Standby
			On
		Standby Mode	Eco
			Normal
		Auto Power Off	Off
			15 Minutes
			30 Minutes
			60 Minutes
			120 Minutes
			Custom
	HDMI Settings	CEC	Off
			On
		HDMI ARC	Off
			On
	Information	Firmware Version	
		MCU Version	
		Baud Rate	
		Resolution	
		MAC Address	
		Used Time	
Firmware Upgrade	Update by USB		
	Updated by OTA		
Factory Reset	OK		
	Cancel		

Menu Options

Adjust

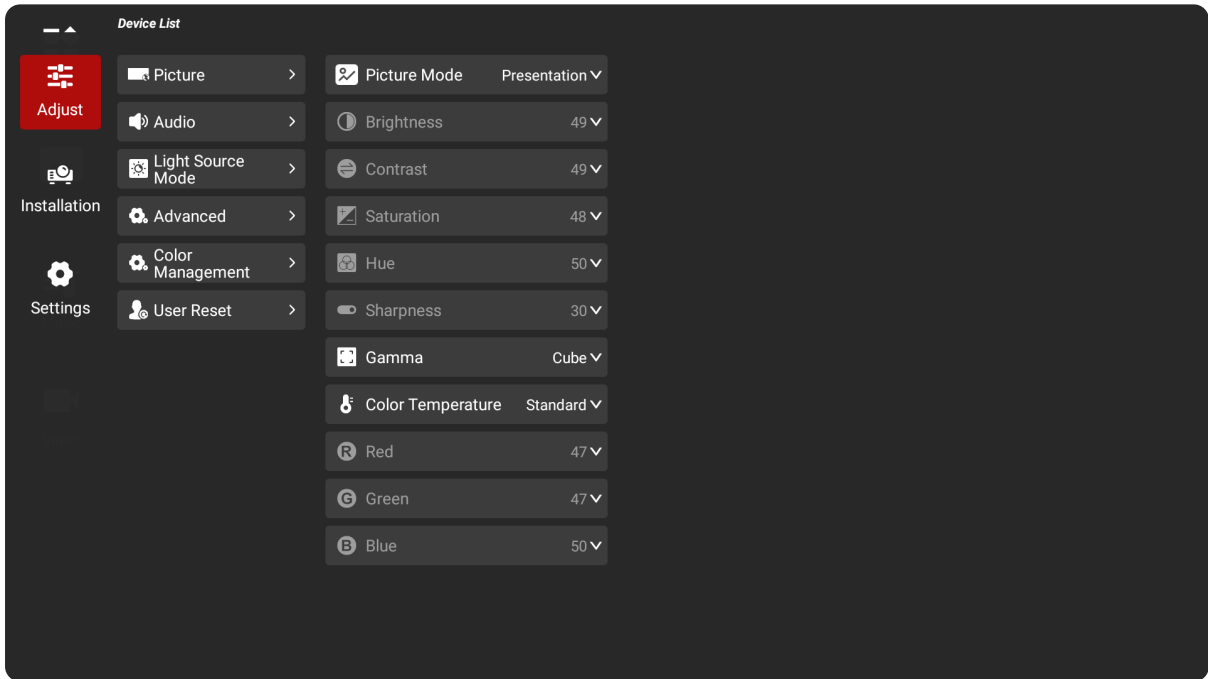

Menu		Description	
Picture	Picture Mode	There are several predefined picture modes that you can choose from for your viewing preference.	
		Brightest	Suitable for bright, well-lit environments.
		Presentation	Suitable for most presenting needs for business and education environments.
		Movie	Provides the best balance of detail and colors for watching movies.
		Golf	Suitable for golf simulators.
		Game	Optimizes your projector for maximum contrast and vivid colors. With this mode, you can shadow detail when playing games.
		HDR	Enable for HDR supported content and darker blacks, brighter highlights, and vivid color.
		User	User-specific, custom image settings.

Menu		Description	
Picture	Brightness	The higher the value, the brighter the image. Lower values will result in a darker image.	
	Contrast	Use this to set the peak white level after you have previously adjusted the Brightness setting to suit your selected input and viewing environment.	
	Saturation	Refers to the amount of that color in a video picture.	
	Hue	Adjust the color level.	
	Sharpness	A higher value will sharpen the image, while a lower value will soften the image.	
	Gamma	Manually adjust the brightness level of the monitor's grayscale levels.	
	Color Temperature	Standard/ Warm/Cool	Select from Standard, Warm, or Cool color temperatures.
		User	Set a custom color temperature.
	Red	Adjusts the contrast levels of red.	
	Green	Adjusts the contrast levels of green.	
	Blue	Adjusts the contrast levels of blue.	
Audio	Volume	Decrease or increase the sound level.	
	S/PDIF	Enable or disable the S/PDIF function.	
Light Source Mode	Normal	Standard operating mode.	
	ECO	Lower the light output, lowering power consumption.	
	Adjust	Select the power percentage (50%~100%) for brightness mode.	

Menu		Description
Aspect Ratio	Auto	Scales an image proportionally to fit the projector's native resolution in its horizontal width. This is suitable for the incoming image which is neither in 4:3 nor 16:9 and you want to make most use of the screen without altering the image's aspect ratio.
	Full	Projects the image as its original resolution and resizes it to fit within the display area.
	4:3	Scales an image so that it is displayed in the center of the screen with a 4:3 aspect ratio. This is most suitable for 4:3 images like computer monitors, standard definition TV, and 4:3 aspect DVD movies, as it displays them without aspect alteration.
	16:9	Scales an image so that it is displayed in the center of the screen with a 16:9 aspect ratio. This is most suitable for images which are already in a 16:9 aspect, like high definition TV, as it displays them without aspect alteration.
	16:10	Scales an image so that it is displayed in the center of the screen with a 16:10 aspect ratio. This is most suitable for images which are already in a 16:10 aspect, as it displays them without aspect alteration.
	21:9	Scales an image for a MTR application.
Magnify	Zoom	Reduce or magnify the projected image.
	Positions	Pan the enlarged image to fit the display area and make the necessary adjustments.
Advanced	HDMI Range	Allows the user to select HDMI greyscale range between 0~255 (full range), 16~240 (limited range) or Auto by the signal type detected.
	HDMI EDID	Used to configure the display settings when connecting to another device.
	DCR	Detects the image signal and intelligently controls the backlight brightness and color.
Color Management	Hue	Adjust the color level.
	Saturation	Refers to the amount of that color in a video picture.
	Gain	Adjust white temperature or a specific color temperature and gain value (red, green, blue).
User Reset	Reset the settings to their default values.	

Installation

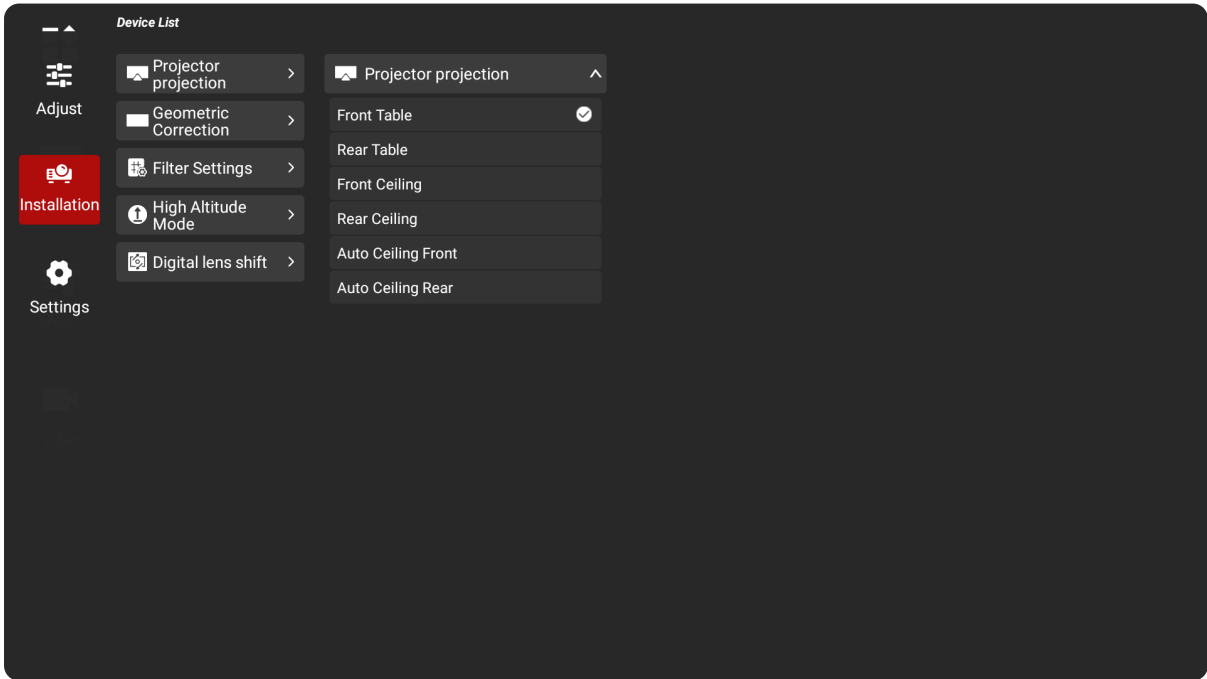

Menu		Description
Projector Projection	Select the preferred projection location.	
Geometric² Correction	Keystone	Adjust image distortion.
	4 Corner	Adjusts each corner to make a square image when the projection surface is not level.
Filter Settings	Review the filter's usage hours and enable or disable a warning message when the filter is used for a set amount of time.	
High Altitude Mode	When turned on, the fans will spin faster for better cooling and performance. This is useful for high altitude environments where the air is thin. If set to Auto , the projector will activate the high-altitude mode automatically.	
Digital Lens Shift	Digitally adjust the position of the projected image.	

2 - The default Keystone settings will be cleared when using 4-corner Correction.

Settings

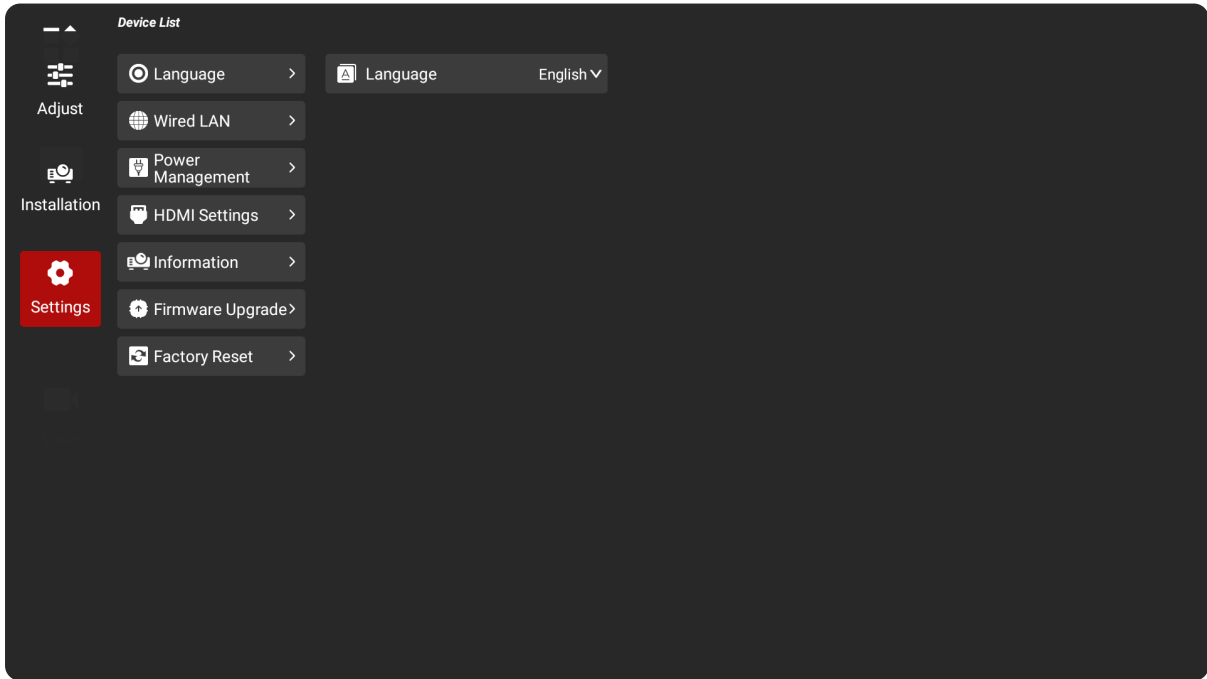

Menu	Description
Language	Select the On-Screen Display (OSD) Menu language.
Wired LAN	Set DHCP to Auto or input a Static IP.
Power Management	Enable or disable Power On Mode and Auto Power Off, or set the Standby Mode type.
HDMI Settings	CEC When you connect HDMI CEC-compatible devices to the projector with HDMI cables, you can control them on the same power on or power off status using the HDMI CEC control feature in the projector's OSD. This lets one device or multiple devices in a group power on or power off via HDMI CEC in a typical configuration. NOTE: ARC will be turned off if CEC is disabled.
	HDMI ARC Enable or disable HDMI ARC support.
Information	View Firmware Version, MCU Version, Baude Rate, Resolution, MAC Address, and Used Time information.
Firmware Upgrade	Update the firmware by USB or OTA.

Menu	Description
Factory Reset	<p>Returns all settings to the factory preset values.</p> <p>NOTE:</p> <ul style="list-style-type: none">• When using Reset Settings, the following settings will still remain: Language, Projector Projection, Baud Rate, High Altitude, and Light Source Hours.• The projector will restart after the Factory Reset completes.

Controlling the Projector through a Network

The projector provides diverse networking and remote management features. The LAN /RJ45 function of the projector, through a network, can remotely manage: Power On/Off, Volume adjustment, Input select, Brightness, and more.

1. Connect the projector to a network via the LAN/RJ45 port.
2. Open the On-Screen Display Menu and go to: **Advanced > Network Setup**.
3. Select **DHCP** and turn it **On** to obtain an IP address automatically; or select **Off** to enter the network information manually.

NOTE: Please wait for around 15~20 seconds, then re-enter the **Network Setup** settings page. The Projector IP Address, Subnet Mask, Default Gateway, DNS Server settings will be displayed. Make note of the IP address displayed in the Projector IP Address row.

4. Using a web browser, and under the same network, type in the projector's IP address.
5. Enter the user name and password, then click **Log in**.

Appendix

Specifications

Item	Category	Specifications	
		LSC600WU LSC601WU	LSC650WU LSC651WU LSC730WU LSC731WU LSC800WU LSC801WU
Projector	Type	Laser	
	Display Size	30"~300"	
	Throw Ratio	1.08~1.76	1.2~2.01
	Lens	1.6x	
	Display System	3LCD	
Input Signal	HDMI	f_h : 15K~100 kHz, f_v : 23K~85 Hz, Pixel rate: 160 MHz	
	VGA	f_h : 15K~100 kHz, f_v : 23K~85 Hz, Pixel rate: 300 MHz	
Resolution	Native	1920 x 1200	
Power	Input Voltage	AC 100-240V, 50/60 Hz (auto switch)	
Operating Conditions	Altitude	1,700 to 3,000 m at 0°C to 40°C ¹	
		5,577.43 to 9,842.52 ft at 32°F to 104°F ¹	
	Relative Humidity	20% to 80% (non-condensing)	
	Temperature	0°C to 40°C	
32°F to 104°F			
Storage Conditions	Relative Humidity	10% to 85% (non-condensing)	
	Temperature	-10°C to 50°C	
		-14°F to 122°F	
Dimensions	Physical (W x D x H)	405 x 358 x 137 mm	
		15.94" x 14.09" x 5.39"	
Weight	Physical	7.9 kg	
		17.42 lb	

1 - With High Altitude Mode enabled.

Item	Category	Specifications	
		LSC600WU LSC601WU	LSC650WU LSC651WU LSC730WU LSC731WU LSC800WU LSC801WU
Power Consumption	On ²	LSC600WU: 320W (Typical)	LSC650WU: 330W (Typical)
		LSC601WU: 330W (Typical)	LSC651WU: 340W (Typical)
			LSC730WU: 365W (Typical)
			LSC731WU: 375W (Typical)
			LSC800WU: 375W (Typical)
			LSC801WU: 385W (Typical)
	Off	< 0.5W (Standby)	

2 - The test condition follows EEI standards.

Item	Category	Specifications		
		LSC600W-ST LSC601W-ST	LSC600WU-ST LSC601WU-ST	LSC730WU-ST LSC731WU-ST
Projector	Type	Laser		
	Display Size	55"~180"		50"~300"
	Throw Ratio	0.44		0.679~0.821
	Lens	Fixed		1.2x
	Display System	3LCD		
Input Signal	HDMI	f _h : 15K~100 kHz, f _v : 23K~85 Hz, Pixel rate: 160 MHz		
	VGA	f _h : 15K~100 kHz, f _v : 23K~85 Hz, Pixel rate: 300 MHz		
Resolution	Native	1280 x 800	1920 x 1200	
Power	Input Voltage	AC 100-240V, 50/60 Hz (auto switch)		
Operating Conditions	Altitude	1,700 to 3,000 m at 0°C to 40°C ³		
		5,577.43 to 9,842.52 ft at 32°F to 104°F ¹		
	Relative Humidity	20% to 80% (non-condensing)		
	Temperature	0°C to 40°C 32°F to 104°F		
Storage Conditions	Relative Humidity	10% to 85% (non-condensing)		
	Temperature	-10°C to 50°C		
		-14°F to 122°F		
Dimensions	Physical (W x D x H)	405 x 404 x 164 mm		405 x 425 x 137 mm
		15.94" x 15.91" x 6.46"		15.94" x 16.73" x 5.39"
Weight	Physical	8.1 kg		
		17.86 lb		
Power Consumption	On ⁴	LSC600W-ST: 325W (Typical)	LSC600WU-ST: 335W (Typical)	LSC730WU-ST: 375W (Typical)
		LSC601W-ST: 335W (Typical)	LSC601WU-ST: 345W (Typical)	LSC731WU-ST: 385W (Typical)
	Off	< 0.5W (Standby)		

3 - With High Altitude Mode enabled.

4 - The test condition follows EEI standards.

Item	Category	Specifications	
		LSC600-4K LSC601-4K	LSC700-4K LSC701-4K
Projector	Type	Laser	
	Display Size	30"~300"	
	Throw Ratio	1.2~2.01	
	Lens	1.6x	
	Display System	3LCD	
Input Signal	HDMI	f _h : 15K~100 kHz, f _v : 23K~85 Hz, Pixel rate: 600 MHz	
Resolution	Native	1920 x 1200 (supports 4K enhancement)	
Power	Input Voltage	AC 100-240V, 50/60 Hz (auto switch)	
Operating Conditions	Altitude	1,700 to 3,000 m at 0°C to 40°C ⁵	
		5,577.43 to 9,842.52 ft at 32°F to 104°F ¹	
	Relative Humidity	20% to 80% (non-condensing)	
		Temperature	0°C to 40°C
			32°F to 104°F
Storage Conditions	Relative Humidity	10% to 85% (non-condensing)	
	Temperature	-10°C to 50°C	
		-14°F to 122°F	
Dimensions	Physical (W x D x H)	405 x 373 x 137 mm	
		15.94" x 14.69" x 5.39"	
Weight	Physical	7.9 kg	
		17.42 lb	
Power Consumption	On ⁶	LSC600-4K : 315W (Typical)	LSC700-4K: 380W (Typical)
		LSC601-4K: 325W (Typical)	LSC701-4K: 390W (Typical)
	Off	< 0.5W (Standby)	

5- With High Altitude Mode enabled.

6- The test condition follows EEI standards.

Projector Dimensions

LSC600WU | LSC601WU | LSC650WU | LSC651WU | LSC730WU | LSC731WU
| LSC800WU | LSC801WU | LSC600-4K | LSC601-4K | LSC700-4K | LSC701-4K

405 mm (W) x 358 mm (D) x 137 mm (H)

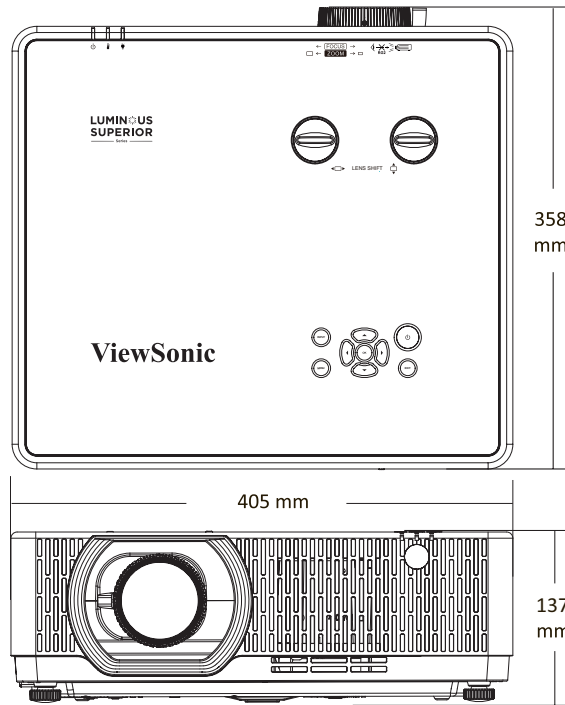

LSC600W-ST | LSC601W-ST | LSC600WU-ST | LSC601WU-ST

405 mm (W) x 404 mm (D) x 164 mm (H)

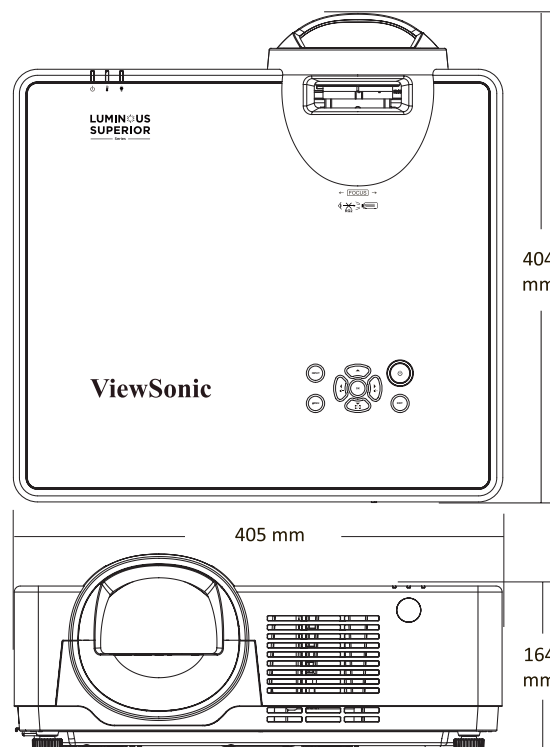

LSC730WU-ST | LSC731WU-ST

405 mm (W) x 425 mm (D) x 137 mm (H)

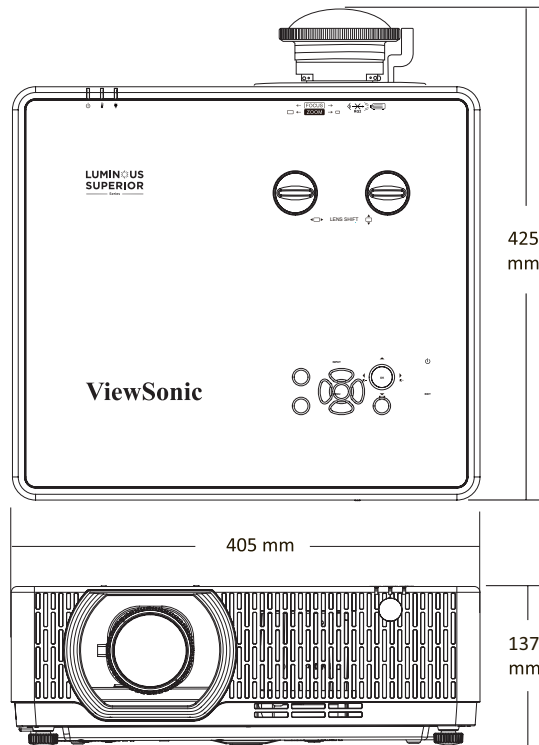

Timing Chart

LSC600W-ST | LSC601W-ST | LSC600WU-ST | LSC601WU-ST | LSC730WU-ST | LSC731WU-ST | LSC600WU | LSC601WU | LSC650WU | LSC651WU | LSC730WU | LSC731WU | LSC800WU | LSC801WU

PC Signal (VGA)

Resolution	Refresh Rate
720 x 480i	60 Hz
720 x 576i	50 Hz
720 x 480p	60 Hz
720 x 576p	50 Hz
1280 x 720p	50, 60 Hz
1920 x 1080i	50, 60 Hz
1920 x 1080p	24, 50, 60 Hz
640 x 480	60, 67, 72, 75, 85 Hz
800 x 600	56, 60, 72, 75, 85 Hz
832 x 624	75 Hz
1024 x 768	60, 70, 75, 85 Hz
1152 x 864	70, 75 Hz
1280 x 720	60 Hz
1280 x 768	60, 75, 85 Hz
1280 x 800	60, 75, 85 Hz
1280 x 960	60 Hz
1280 x 1024	60, 72, 75, 85 Hz
1366 x 768	60 Hz
1400 x 1050	60, 75 Hz
1440 x 900	60 Hz
1600 x 900	60 Hz
1680 x 1050	60 Hz
1920 x 1080	60 Hz
1920 x 1200	60 Hz

HDMI Signal

HDMI Video

Resolution	Refresh Rate
720 x 480p	60 Hz
720 x 480i	60 Hz
720 x 576p	50 Hz
720 x 576i	60 Hz
1280 x 720p	50, 60 Hz
1920 x 1080i	50, 60 Hz
1920 x 1080p	24, 50, 60 Hz

HDMI PC

Resolution	Refresh Rate
640 x 480	60, 67, 72, 75, 85 Hz
800 x 600	56, 60, 72, 75, 85 Hz
832 x 624	75 Hz
1024 x 768	60, 70, 75, 85 Hz
1152 x 864	70, 75 Hz
1280 x 720	60 Hz
1280 x 768	60, 75, 85 Hz
1280 x 800	60, 75, 85 Hz
1280 x 960	60 Hz
1280 x 1024	60, 72, 75, 85 Hz
1366 x 768	60 Hz
1400 x 1050	60, 75 Hz
1440 x 900	60 Hz
1600 x 900	60 Hz
1680 x 1050	60 Hz
1920 x 1080	60 Hz
1920 x 1200	60 Hz
3840 x 2160	30, 60 Hz

HDBaseT Signal

Resolution	Refresh Rate
720 x 480p	60 Hz
720 x 480i	60 Hz
720 x 576p	50 Hz
720 x 576i	50 Hz
1280 x 720p	50 Hz, 60 Hz
1920 x 1080i	50 Hz, 60 Hz
1920 x 1080p	24 Hz, 50 Hz, 60 Hz
640 x 480	60, 67, 72, 75, 85 Hz
800 x 600	56, 60, 72, 75, 85 Hz
832 x 624	75 Hz
1024 x 768	60, 70, 75, 85 Hz
1152 x 864	70, 75 Hz
1280 x 720	60 Hz
1280 x 768	60, 75, 85 Hz
1280 x 800	60, 75, 85 Hz
1280 x 960	60 Hz
1280 x 1024	60, 72, 75, 85 Hz
1366 x 768	60 Hz
1400 x 1050	60, 75 Hz
1440 x 900	60 Hz
1600 x 900	60 Hz
1600 x 1200	60 Hz
1680 x 1050	60 Hz
1920 x 1080	60 Hz
1920 x 1200	60 Hz
2560 X 1080	60 Hz

HDMI Signal

LSC600-4K | LSC601-4K | LSC700-4K | LSC701-4K

HDMI Video / HDBaseT

Resolution	Refresh Rate
640 x 480p	60 Hz
720 x 480p	60 Hz
720 x 480i	60 Hz
720 x 576p	50 Hz
720 x 576i	50 Hz
1280 x 720p	24, 30, 50, 60 Hz
1920 x 1080i	50, 60 Hz
1920 x 1080p	24, 30, 50, 60 Hz
3840 x 2160 ⁷	24, 25, 30, 60 Hz
4096 x 2160 ⁷	24, 30, 50, 60 Hz

HDMI PC

Resolution	Refresh Rate
1024 x 768	60 Hz
1280 x 800	60 Hz
1920 x 1080	60 Hz
1920 x 1200	60 Hz
2560 x 1080	60 Hz
3840 x 2160	60 Hz

⁷ - Does not support HDBaseT.

Troubleshooting

This section describes some common problems that you may experience when using the projector.

Problem or Issue	Possible Solutions
The projector does not turn on	<ul style="list-style-type: none"> • Ensure the power cord is properly attached to the projector and to the power outlet. • If the cooling process has not completed, please wait until it has finished then try to turn on the projector again. • If the above does not work, try another power outlet or another electrical device with the same power outlet.
There is no picture	<ul style="list-style-type: none"> • Ensure the video source cable is connected properly, and that the video source is turned on. • If the input source is not selected automatically, select the correct source with the “Source Input” on either the projector or the remote control.
The image is blurred	<ul style="list-style-type: none"> • Adjusting focus with the Focus Ring will help correctly focus the projection lens. • Ensure the projector and screen are aligned properly. If necessary, adjust the height of the projector as well as the projection angle and direction.
The image is reversed	<ul style="list-style-type: none"> • Open the OSD Menu and go to: Setup > Projection and adjust the projection option.
The image is stretched when projecting a 16:9 DVD	<ul style="list-style-type: none"> • When you play an anamorphic DVD or 16:9 DVD, the projector will show the best image in 16:9. • If you play a 4:3 format DVD title, please change the format as 4:3 in projector OSD Menu. • Please setup the display format as 16:9 (wide) aspect ratio on the DVD player.
The remote control does not work	<ul style="list-style-type: none"> • Ensure there are no obstacles between the remote control and projector; and that they are within range, 8 m (26 ft). • The batteries may be out of power, please check and replace if necessary.

Problem or Issue	Possible Solutions
The projector stops responding to all controls	<ul style="list-style-type: none">• Turn off the projector and unplug the power cord. Wait at least 20 seconds then reconnect and try again.

LED Indicators

When the warning indicators (see below) light up or flash, the projector will automatically shutdown. Unplug the power cord from the projector, wait for 30 seconds and try again. If the warning indicators light up or flash, please contact your nearest service center for assistance.

LSC730WU | LSC731WU | LSC800WU | LSC801WU | LSC730WU-ST | LSC731WU-ST | LSC600W-ST | LSC601W-ST | LSC600WU-ST | LSC601WU-ST | LSC600WU | LSC601WU | LSC650WU | LSC651WU

Status and Description	Power Indicator Light	Status Indicator Light	Light Source Indicator Light
Normal Standby (> 0.5W)	Flashing Orange (quick)	Off	Off
Network Standby	Steady Orange	Off	Off
Eco Standby (< 0.5W)	Flashing Orange	Off	Off
Power On (Warming)	Steady Blue	Off	Steady Green
Power Off (Cooling)	Flashing Green	Off	Off
Light Source Error	Flashing Red	Steady Green or Flashing Green	Steady Red or Flashing Red
Fan Error	Steady Red	Steady Orange or Flashing Orange or Off	Off or Flashing Orange
Temperature Error	Steady Red	Off	Off
Filter Error	Steady Red	Flashing Red	Off

LSC600-4K | LSC601-4K | LSC700-4K | LSC701-4K

Status and Description	Power Indicator Light	Status Indicator Light	Light Source Indicator Light
Normal Standby (> 0.5W)	Steady Orange	Off	Off
Network/Eco Standby	Flashing Orange	Off	Off
Power On (Warming)	Steady Green	Off	Flashing Green
Power Off (Cooling)	Flashing Red	Off	Off
Light Source Error	Steady Red	Flashing Red	Steady Red
Fan Error	Steady Red	Flashing Orange	Off
Temperature Error	Steady Red	Flashing Red	Off

Maintenance

General Precautions

- Make sure the projector is turned off and the power cable is unplugged from the power outlet.
- Never remove any parts from the projector. Contact ViewSonic® or a reseller when any part of the projector needs replacing.
- Never spray or pour any liquid directly onto the case.
- Handle the projector with care, as a darker-colored projector, if scuffed, may show marks more clearly than a lighter-colored projector.

Cleaning the Lens

- Use a canister of compressed air to remove dust.
- If the lens is still not clean, use lens-cleaning paper or moisten a soft cloth with lens cleaner and gently wipe the surface.

CAUTION: Never rub the lens with abrasive materials.

Cleaning the Case

- Use a soft, lint-free, dry cloth to remove dirt or dust.
- If the case is still not clean, apply a small amount of non-ammonia, non-alcohol based, mild non-abrasive detergent onto a clean, soft, lint-free cloth, then wipe the surface.

CAUTION: Never use wax, alcohol, benzene, thinner, or other chemical detergents.

Storing the Projector

If you intend to store the projector for an extended period of time:

- Ensure the temperature and humidity of the storage area are within the recommend range.
- Retract the adjuster foot completely.
- Remove the batteries from the remote control.
- Pack the projector in its original packaging or equivalent.

Disclaimer

- ViewSonic® does not recommend the use of any ammonia or alcohol-based cleaners on the lens or case. Some chemical cleaners have been reported to damage the lens and/or case of the projector.
- ViewSonic® will not be liable for damage resulting from use of any ammonia or alcohol-based cleaners.

Cleaning the Filter

Please follow these steps to clean your filter:

1. Turn off the projector and unplug it from its power source.
2. Remove the filter.
3. Gently clean it with a brush.
4. Replace the filter, making sure it has been inserted fully.

CAUTION: Do not operate the projector after removing the filter. Otherwise, dust will adhere to the lens assembly, compromising image quality.

Regulatory and Service Information

Compliance Information

This section addresses all connected requirements and statements regarding regulations. Confirmed corresponding applications shall refer to nameplate labels and relevant markings on the unit.

FCC Compliance Statement

This device complies with part 15 of FCC Rules. Operation is subject to the following two conditions: (1) this device may not cause harmful interference, and (2) this device must accept any interference received, including interference that may cause undesired operation. This equipment has been tested and found to comply with the limits for a Class B digital device, pursuant to part 15 of the FCC Rules.

These limits are designed to provide reasonable protection against harmful interference in a residential installation. This equipment generates, uses, and can radiate radio frequency energy, and if not installed and used in accordance with the instructions, may cause harmful interference to radio communications. However, there is no guarantee that interference will not occur in a particular installation. If this equipment does cause harmful interference to radio or television reception, which can be determined by turning the equipment off and on, the user is encouraged to try to correct the interference by one or more of the following measures:

- Reorient or relocate the receiving antenna.
- Increase the separation between the equipment and receiver.
- Connect the equipment into an outlet on a circuit different from that to which the receiver is connected.
- Consult the dealer or an experienced radio/TV technician for help.

Warning: You are cautioned that changes or modifications not expressly approved by the party responsible for compliance could void your authority to operate the equipment.

Industry Canada Statement

CAN ICES (A) / NMB (A)

This Class A digital apparatus complies with Canadian ICES-003.

Cet appareil numérique de classe A est conforme à la norme NMB-003 du Canada.

CE Conformity for European Countries

CE The device complies with the EMC Directive 2014/30/EU and Low Voltage Directive 2014/35/EU. Ecodesign Directive 2009/125/EC.

The following information is only for EU-member states:

The mark shown to the right is in compliance with the Waste Electrical and Electronic Equipment Directive 2012/19/EU (WEEE). The mark indicates the requirement NOT to dispose of the equipment as unsorted municipal waste, but use the return and collection systems according to local law.



Declaration of RoHS2 Compliance

This product has been designed and manufactured in compliance with Directive 2011/65/EU of the European Parliament and the Council on restriction of the use of certain hazardous substances in electrical and electronic equipment (RoHS2 Directive) and is deemed to comply with the maximum concentration values issued by the European Technical Adaptation Committee (TAC) as shown below:

Substance	Proposed Maximum Concentration	Actual Concentration
Lead (Pb)	0.1%	< 0.1%
Mercury (Hg)	0.1%	< 0.1%
Cadmium (Cd)	0.01%	< 0.01%
Hexavalent Chromium (Cr6 ⁺)	0.1%	< 0.1%
Polybrominated biphenyls (PBB)	0.1%	< 0.1%
Polybrominated diphenyl ethers (PBDE)	0.1%	< 0.1%
Bis (2-ethylhexyl) phthalate (DEHP)	0.1%	< 0.1%
Butyl benzyl phthalate (BBP)	0.1%	< 0.1%
Dibutyl phthalate (DBP)	0.1%	< 0.1%
Diisobutyl phthalate (DIBP)	0.1%	< 0.1%

Certain components of products as stated above are exempted under the Annex III of the RoHS2 Directives as noted below. Examples of exempted components are:

- Mercury in cold cathode fluorescent lamps and external electrode fluorescent lamps (CCFL and EEFL) for special purposes not exceeding (per lamp):
 - » Short length (500 mm): maximum 3.5 mg per lamp.
 - » Medium length (> 500 mm and 1,500 mm): maximum 5 mg per lamp.
 - » Long length (> 1,500 mm): maximum 13 mg per lamp.
- Lead in glass of cathode ray tubes.
- Lead in glass of fluorescent tubes not exceeding 0.2% by weight.
- Lead as an alloying element in aluminum containing up to 0.4% lead by weight.
- Copper alloy containing up to 4% lead by weight.
- Lead in high melting temperature type solders (i.e. lead-based alloys containing 85% by weight or more lead).
- Electrical and electronic components containing lead in a glass or ceramic other than dielectric ceramic in capacitors, e.g. piezoelectronic devices, or in a glass or ceramic matrix compound.

Indian Restriction of Hazardous Substances

Restriction on Hazardous Substances statement (India). This product complies with the “India E-waste Rule 2011” and prohibits use of lead, mercury, hexavalent chromium, polybrominated biphenyls or polybrominated diphenyl ethers in concentrations exceeding 0.1 weight % and 0.01 weight % for cadmium, except for the exemptions set in Schedule 2 of the Rule.

Product Disposal at End of Product Life

ViewSonic® respects the environment and is committed to working and living green. Thank you for being part of Smarter, Greener Computing. Please visit the ViewSonic® website to learn more.

USA & Canada:

<https://www.viewsonic.com/us/go-green-with-viewsonic>

Europe:

<https://www.viewsonic.com/eu/environmental-social-governance/recycle>

Taiwan:

<https://recycle.moenv.gov.tw/>

For EU users, please contact us for any safety/accident issue experienced with this product:

ViewSonic Europe Limited



Haaksbergweg 75
1101 BR Amsterdam
Netherlands



+31 (0) 650608655



EPREL@viewsoniceurope.com



<https://www.viewsonic.com/eu/>

Copyright Information

Copyright© ViewSonic® Corporation, 2024. All rights reserved.

Macintosh and Power Macintosh are registered trademarks of Apple Inc.

Microsoft, Windows, and the Windows logo are registered trademarks of Microsoft Corporation in the United States and other countries.

ViewSonic® and the three birds logo are registered trademarks of ViewSonic® Corporation.

VESA is a registered trademark of the Video Electronics Standards Association. DPMS, DisplayPort, and DDC are trademarks of VESA.

ENERGY STAR® is a registered trademark of the U.S. Environmental Protection Agency (EPA).

As an ENERGY STAR® partner, ViewSonic® Corporation has determined that this product meets the ENERGY STAR® guidelines for energy efficiency.

Disclaimer: ViewSonic® Corporation shall not be liable for technical or editorial errors or omissions contained herein; nor for incidental or consequential damages resulting from furnishing this material, or the performance or use of this product.

In the interest of continuing product improvement, ViewSonic® Corporation reserves the right to change product specifications without notice. Information in this document may change without notice.

No part of this document may be copied, reproduced, or transmitted by any means, for any purpose without prior written permission from ViewSonic® Corporation.

LSC600W-ST_LSC601W-ST_LSC600WU-ST_LSC601WU-ST_LSC730WU-ST_LSC731WU-ST_LSC600WU_LSC601WU_LSC650WU_LSC651WU_LSC730WU_LSC731WU_LSC800WU_LSC801WU_LSC600-4K_LSC601-4K_LSC700-4K_LSC701-4K_UG_ENG_1a_20240924

Customer Service

For technical support or product service, see the table below or contact your reseller.

NOTE: You will need the product's serial number.

Country/ Region	Website	Country/ Region	Website
Asia Pacific & Africa			
Australia	www.viewsonic.com/au/	Bangladesh	www.viewsonic.com/bd/
中国 (China)	www.viewsonic.com.cn	香港 (繁體中文)	www.viewsonic.com/hk/
Hong Kong (English)	www.viewsonic.com/hk-en/	India	www.viewsonic.com/in/
Indonesia	www.viewsonic.com/id/	Israel	www.viewsonic.com/il/
日本 (Japan)	www.viewsonic.com/jp/	Korea	www.viewsonic.com/kr/
Malaysia	www.viewsonic.com/my/	Middle East	www.viewsonic.com/me/
Myanmar	www.viewsonic.com/mm/	Nepal	www.viewsonic.com/np/
New Zealand	www.viewsonic.com/nz/	Pakistan	www.viewsonic.com/pk/
Philippines	www.viewsonic.com/ph/	Singapore	www.viewsonic.com/sg/
臺灣 (Taiwan)	www.viewsonic.com/tw/	ประเทศไทย	www.viewsonic.com/th/
Việt Nam	www.viewsonic.com/vn/	South Africa & Mauritius	www.viewsonic.com/za/
Americas			
United States	www.viewsonic.com/us	Canada	www.viewsonic.com/us
Latin America	www.viewsonic.com/la		
Europe			
Europe	www.viewsonic.com/eu/	France	www.viewsonic.com/fr/
Deutschland	www.viewsonic.com/de/	Қазақстан	www.viewsonic.com/kz/
Россия	www.viewsonic.com/ru/	España	www.viewsonic.com/es/
Türkiye	www.viewsonic.com/tr/	Україна	www.viewsonic.com/ua/
United Kingdom	www.viewsonic.com/uk/		

Limited Warranty

ViewSonic® Projector

What the warranty covers:

ViewSonic® warrants its products to be free from defects in material and workmanship, under normal use, during the warranty period. If a product proves to be defective in material or workmanship during the warranty period, ViewSonic® will, at its sole option, repair or replace the product with a like product. Replacement product or parts may include remanufactured or refurbished parts or components.

Limited Three (3) year General Warranty:

Subject to the more limited one (1) year warranty set out below, North and South America: Three (3) years warranty for all parts excluding the lamp, three (3) years for labor, and one (1) year for the original lamp from the date of the first consumer purchase.

Other regions or countries: Please check with your local dealer or local ViewSonic® office for the warranty information.

Limited One (1) year Heavy Usage Warranty:

Under heavy usage settings, where a projector's use includes more than fourteen (14) hours average daily usage, North and South America: One (1) year warranty for all parts excluding the lamp, one (1) year for labor, and ninety (90) days for the original lamp from the date of the first consumer purchase; Europe: One (1) year warranty for all parts excluding the lamp, one (1) year for labor, and ninety (90) days for the original lamp from the date of the first consumer purchase. Other regions or countries: Please check with your local dealer or local ViewSonic® office for the warranty information. Lamp warranty subject to terms and conditions, verification and approval. Applies to manufacturer's installed lamp only. All accessory lamps purchased separately are warranted for 90 days.

Who the warranty protects:

This warranty is valid only for the first consumer purchaser.

What the warranty does not cover:

1. Any product on which the serial number has been defaced, modified, or removed.
2. Damage, deterioration, or malfunction resulting from:
 - » Accident, misuse, neglect, fire, water, lightning, or other acts of nature, unauthorized product modification, or failure to follow instructions supplied with the product.
 - » Operation outside of product specifications.
 - » Operation of the product for other than the normal intended use or not under normal conditions.
 - » Repair or attempted repair by anyone not authorized by ViewSonic®.
 - » Any damage of the product due to shipment.
 - » Removal or installation of the product.
 - » Causes external to the product, such as electric power fluctuations or failure.
 - » Use of supplies or parts not meeting Viewsonic's specifications.
 - » Normal wear and tear.
 - » Any other cause which does not relate to a product defect.
3. Removal, installation, and set-up service charges.

How to get service:

1. For information about receiving service under warranty, contact ViewSonic® Customer Support (Please refer to the "Customer Support" page). You will need to provide your product's serial number.
2. To obtain warranted service, you will be required to provide: (a) the original dated sales slip, (b) your name, (c) your address, (d) a description of the problem, and (e) the serial number of the product.
3. Take or ship the product, freight prepaid, in the original container to an authorized ViewSonic® service center or ViewSonic®.
4. For additional information or the name of the nearest ViewSonic® service center, contact ViewSonic®.

Limitation of implied warranties:

There are no warranties, express or implied, which extend beyond the description contained herein including the implied warranty of merchantability and fitness for a particular purpose.

Exclusion of damages:

ViewSonic's liability is limited to the cost of repair or replacement of the product. ViewSonic® shall not be liable for:

1. Damage to other property caused by any defects in the product, damages based upon inconvenience, loss of use of the product, loss of time, loss of profits, loss of business opportunity, loss of goodwill, interference with business relationships, or other commercial loss, even if advised of the possibility of such damages.
2. Any other damages, whether incidental, consequential or otherwise.
3. Any claim against the customer by any other party.

Effect of state law:

This warranty gives you specific legal rights, and you may also have other rights which vary from local authority. Some local governments do not allow limitations on implied warranties and/or do not allow the exclusion of incidental or consequential damages, so the above limitations and exclusions may not apply to you.

Sales outside the U.S.A. and Canada:

For warranty information and service on ViewSonic® products sold outside of the U.S.A. and Canada, contact ViewSonic® or your local ViewSonic® dealer.

The warranty period for this product in mainland China (Hong Kong, Macao, and Taiwan Excluded) is subject to the terms and conditions of the Maintenance Guarantee Card.

For users in Europe and Russia, full details of warranty provided can be found at: <http://www.viewsonic.com/eu/> under "Support/Warranty Information".

Mexico Limited Warranty

ViewSonic® Projector

What the warranty covers:

ViewSonic® warrants its products to be free from defects in material and workmanship, under normal use, during the warranty period. If a product proves to be defective in material or workmanship during the warranty period, ViewSonic® will, at its sole option, repair or replace the product with a like product. Replacement product or parts may include remanufactured or refurbished parts or components & accessories.

How long the warranty is effective:

3 years for all parts excluding the lamp, 3 years for labor, 1 year for the original lamp from the date of the first consumer purchase.

Lamp warranty subject to terms and conditions, verification and approval. Applies to manufacturer's installed lamp only.

All accessory lamps purchased separately are warranted for 90 days.

Who the warranty protects:

This warranty is valid only for the first consumer purchaser.

What the warranty excludes and does not cover:

1. Any product on which the serial number has been defaced, modified or removed.
2. Damage, deterioration, or malfunction resulting from:
 - » Accident, misuse, neglect, fire, water, lightning, or other acts of nature, unauthorized product modification, unauthorized attempted repair, or failure to follow instructions supplied with the product.
 - » Any damage of the product due to shipment.
 - » Causes external to the product, such as electrical power fluctuations or failure.
 - » Use of supplies or parts not meeting ViewSonic®'s specifications.
 - » Normal wear and tear.
 - » Any other cause which does not relate to a product defect.
3. Any product exhibiting a condition commonly known as "image burn-in" which results when a static image is displayed on the product for an extended period of time.
4. Removal, installation, insurance, and set-up service charges.

How to get service:

For information about receiving service under warranty, contact ViewSonic® Customer Support (Please refer to the attached “Customer Service” page). You will need to provide your product’s serial number, so please record the product information in the space provided below on your purchase for your future use. Please retain your receipt of proof of purchase to support your warranty claim.

For Your Records

Product Name: _____ Model Number: _____

Document Number: _____ Serial Number: _____

Purchase Date: _____ Extended Warranty Purchase? _____ (Y/N)

If so, what date does warranty expire? _____

1. To obtain warranty service, you will be required to provide (a) the original dated sales slip, (b) your name, (c) your address, (d) a description of the problem, and (e) the serial number of the product.
2. Take or ship the product, in the original container packaging, to an authorized ViewSonic® service center.
3. Round trip transportation costs for in-warranty products will be paid by ViewSonic®.

Limitation of implied warranties:

There are no warranties, express or implied, which extend beyond the description contained herein including the implied warranty of merchantability and fitness for a particular purpose.

Exclusion of damages:

ViewSonic®’s liability is limited to the cost of repair or replacement of the product. ViewSonic® shall not be liable for:

1. Damage to other property caused by any defects in the product, damages based upon inconvenience, loss of use of the product, loss of time, loss of profits, loss of business opportunity, loss of goodwill, interference with business relationships, or other commercial loss, even if advised of the possibility of such damages.
2. Any other damages, whether incidental, consequential or otherwise.
3. Any claim against the customer by any other party.
4. Repair or attempted repair by anyone not authorized by ViewSonic®.

Contact Information for Sales & Authorized Service (Centro Autorizado de Servicio) within Mexico:	
<p align="center">Name, address, of manufacturer and importers: México, Av. de la Palma #8 Piso 2 Despacho 203, Corporativo Interpalmas, Col. San Fernando Huixquilucan, Estado de México Tel: (55) 3605-1099 http://www.viewsonic.com/la/soporte/index.htm</p>	
NÚMERO GRATIS DE ASISTENCIA TÉCNICA PARA TODO MÉXICO: 001.866.823.2004	
<p>Hermosillo: Distribuciones y Servicios Computacionales SA de CV. Calle Juarez 284 local 2 Col. Bugambilias C.P: 83140 Tel: 01-66-22-14-9005 E-Mail: disc2@hmo.megared.net.mx</p>	<p>Villahermosa: Compumantenimientos Garantizados, S.A. de C.V. AV. GREGORIO MENDEZ #1504 COL, FLORIDA C.P. 86040 Tel: 01 (993) 3 52 00 47 / 3522074 / 3 52 20 09 E-Mail: compumantenimientos@prodigy.net.mx</p>
<p>Puebla, Pue. (Matriz): RENTA Y DATOS, S.A. DE C.V. Domicilio: 29 SUR 721 COL. LA PAZ 72160 PUEBLA, PUE. Tel: 01(52).222.891.55.77 CON 10 LINEAS E-Mail: datos@puebla.megared.net.mx</p>	<p>Veracruz, Ver.: CONEXION Y DESARROLLO, S.A DE C.V. Av. Americas # 419 ENTRE PINZÓN Y ALVARADO Fracc. Reforma C.P. 91919 Tel: 01-22-91-00-31-67 E-Mail: gacosta@qplus.com.mx</p>
<p>Chihuahua: Soluciones Globales en Computación C. Magisterio # 3321 Col. Magisterial Chihuahua, Chih. Tel: 4136954 E-Mail: Cefeo@soluglobales.com</p>	<p>Cuernavaca: Compusupport de Cuernavaca SA de CV Francisco Leyva # 178 Col. Miguel Hidalgo C.P. 62040, Cuernavaca Morelos Tel: 01 777 3180579 / 01 777 3124014 E-Mail: aquevedo@compusupportcva.com</p>
<p>Distrito Federal: QPLUS, S.A. de C.V. Av. Coyoacán 931 Col. Del Valle 03100, México, D.F. Tel: 01(52)55-50-00-27-35 E-Mail : gacosta@qplus.com.mx</p>	<p>Guadalajara, Jal.: SERVICRECE, S.A. de C.V. Av. Niños Héroes # 2281 Col. Arcos Sur, Sector Juárez 44170, Guadalajara, Jalisco Tel: 01(52)33-36-15-15-43 E-Mail: mmiranda@servicrece.com</p>
<p>Guerrero Acapulco: GS Computación (Grupo Sesiscomp) Progreso #6-A, Colo Centro 39300 Acapulco, Guerrero Tel: 744-48-32627</p>	<p>Monterrey: Global Product Services Mar Caribe # 1987, Esquina con Golfo Pérsico Fracc. Bernardo Reyes, CP 64280 Monterrey N.L. México Tel: 8129-5103 E-Mail: aydeem@gps1.com.mx</p>
<p>MÉRIDA: ELECTROSER Av Reforma No. 403Gx39 y 41 Mérida, Yucatán, México CP97000 Tel: (52) 999-925-1916 E-Mail: rrrb@sureste.com</p>	<p>Oaxaca, Oax.: CENTRO DE DISTRIBUCION Y SERVICIO, S.A. de C.V. Murguía # 708 P.A., Col. Centro, 68000, Oaxaca Tel: 01(52)95-15-15-22-22 Fax: 01(52)95-15-13-67-00 E-Mail: gpotai2001@hotmail.com</p>
<p>Tijuana: STD Av Ferrocarril Sonora #3780 L-C Col 20 de Noviembr Tijuana, Mexico</p>	<p>FOR USA SUPPORT: ViewSonic® Corporation 381 Brea Canyon Road, Walnut, CA. 91789 USA Tel: 800-688-6688 E-Mail: http://www.viewsonic.com</p>

