

Height-Adjustable Ergonomic Desk Arm Rest - Max. Load 5kg

Product ID

1AHC-DESK-ARM-REST

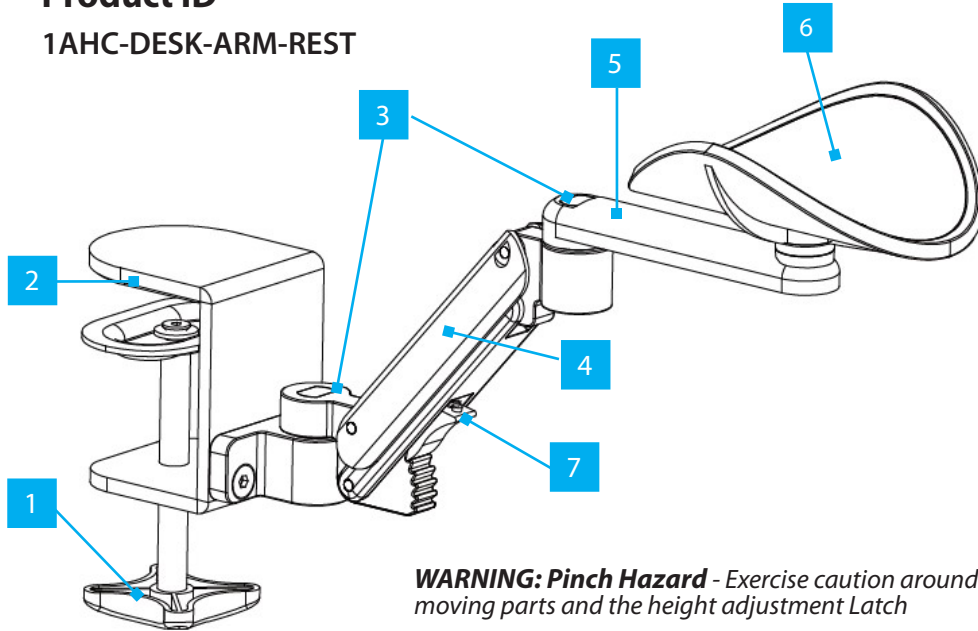

WARNING: Pinch Hazard - Exercise caution around moving parts and the height adjustment Latch

Component	Function
1 Clamp Knob	• To tighten the Desk Clamp
2 Desk Clamp	• To Mount the Desk Arm Rest to a desk(maximum desk thickness 2in / 58mm)
3 Swivel Points	• Swivel Points for the Tilt and Swivel Arms
4 Tilt Arm	• Tilts from 0 to 45 degrees and rotates 180 degrees
5 Swivel Arm	• Rotates 360 degree around the Tilt Arm
6 Elbow/Forearm Support	• Supports the Forearm at a comfortable and ergonomic height from -5mm below to 70mm above the desk and rotates 360 degrees
7 Height Adjustment Latch	• Six Adjustment Angles (0, 10, 20, 25, 35 and 45 degrees)

Package Contents

- Desk Arm Rest x 1
- Quick-Start Guide x 1

Requirements

For the latest manual, product information, technical specifications, and declarations of conformance, please visit: www.startech.com/1AHC-DESK-ARM-REST

- Desk or table of up to 2in (58mm) thickness

Installation

1. Adjust the **Desk Clamp** to the approximate thickness of the desk using the **Clamp Knob** on the bottom of the clamp. (Figure 1)

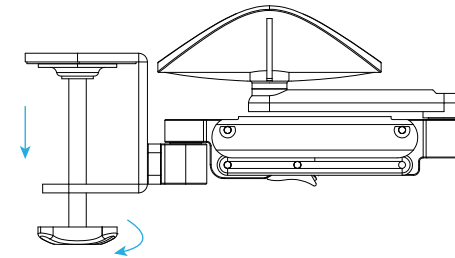

Figure 1

2. Place the **Desk Arm Rest** at the desired edge of the desk and tighten the **Clamp** to the desk using the **Clamp Knob**. (Figure 2)

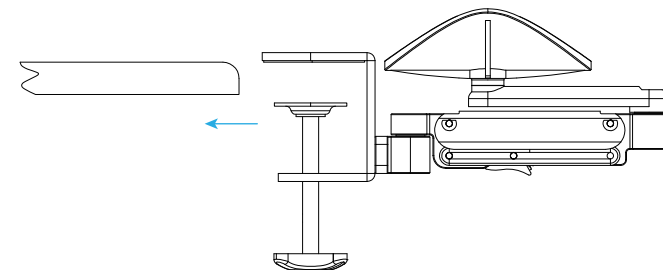

Figure 2

Operation

1. Rotate the **Swivel Arm** from the desk to the desired position. (Figure 3 & 4)

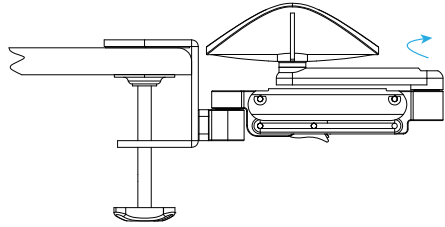

Figure 3

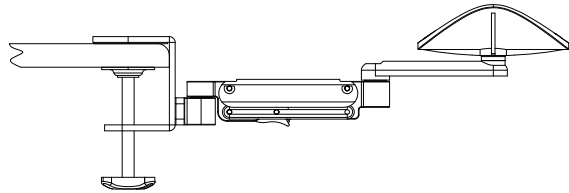

Figure 4

Regulatory Compliance

Use of Trademarks, Registered Trademarks, and other Protected Names and Symbols

This manual may make reference to trademarks, registered trademarks, and other protected names and/or symbols of third-party companies not related in any way to StarTech.com. Where they occur these references are for illustrative purposes only and do not represent an endorsement of a product or service by StarTech.com, or an endorsement of the product(s) to which this manual applies by the third-party company in question. StarTech.com hereby acknowledges that all trademarks, registered trademarks, service marks, and other protected names and/or symbols contained in this manual and related documents are the property of their respective holders.

Warranty Information

This product is backed by a two-year warranty.
For further information on product warranty terms and conditions, please refer to www.startech.com/warranty.

Limitation of Liability

In no event shall the liability of StarTech.com Ltd. and StarTech.com USA LLP (or their officers, directors, employees or agents) for any damages (whether direct or indirect, special, punitive, incidental, consequential, or otherwise), loss of profits, loss of business, or any pecuniary loss, arising out of or related to the use of the product exceed the actual price paid for the product. Some states do not allow the exclusion or limitation of incidental or consequential damages. If such laws apply, the limitations or exclusions contained in this statement may not apply to you.

Safety Measures

Assemble this product according to the instructions. Read the entire manual and ensure the instructions are fully understood before assembling and/or using this product.

Mesures de Sécurité

Assemblez ce produit conformément aux instructions. Lisez l'intégralité du manuel et assurez-vous que les instructions sont bien comprises avant d'assembler et/ou d'utiliser ce produit.

Veiligheidsmaatregelen

Monteer dit product volgens de instructies. Lees de gehele handleiding en zorg ervoor dat u de instructies volledig begrijpt voordat u dit product monteert en/of gebruikt.

Säkerhetsåtgärder

Montera produkten enligt instruktionerna. Läs hela manualen och se till att du har förstått instruktionerna innan du monterar och/eller använder produkten.

2. Adjust the **Tilt Arm** height using the **Height Adjustment Latch** to the desired height. (Figure 5)

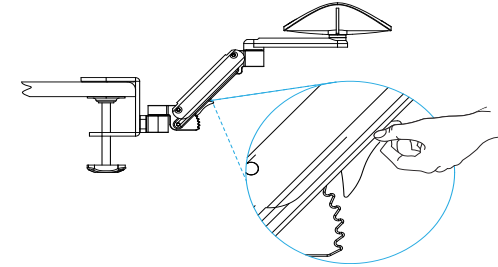

Figure 5

3. Position the **Forearm Support** to a comfortable and ergonomic position. (Figure 6)

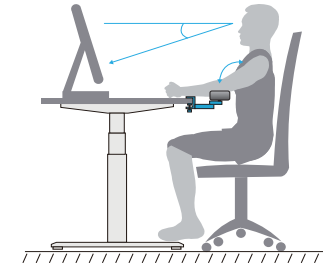

Figure 6

Sicherheitsmaßnahmen

Bauen Sie dieses Produkt gemäß der Anleitung zusammen. Lesen Sie das gesamte Handbuch und stellen Sie sicher, dass Sie die Anweisungen vollständig verstanden haben, bevor Sie dieses Produkt zusammenbauen und/oder verwenden.

安全対策

最初に取扱説明書を最後まで読み、本製品の組み立て方をすべて理解してから組み立て作業を始めて下さい。

Misure di Sicurezza

Leggere l'intero manuale e assicurarsi di aver compreso tutte le istruzioni prima di iniziare ad assemblare e a utilizzare questo prodotto.

Medidas de Seguridad

Monte este producto siguiendo las instrucciones. Lea todo el manual y asegúrese de que las instrucciones se entienden completamente antes de montar y/o utilizar este producto.

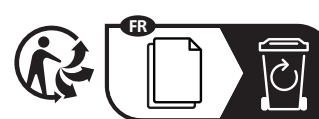

www.quefairedemesdechets.fr

StarTech.com Ltd.
45 Artisans Crescent
London, Ontario
N5V 5E9
Canada

StarTech.com LLP
4490 South Hamilton
Road
Groveport, Ohio
43125
U.S.A.

StarTech.com Ltd.
Unit B, Pinnacle 15
Gowerton Road
Brackmills,
Northampton
NN4 7BW
United Kingdom

StarTech.com Ltd.
Siriusdreef 17-27
2132 WT Hoofddorp
The Netherlands

FR: startech.com/fr
DE: startech.com/de
ES: startech.com/es
NL: startech.com/nl
IT: startech.com/it
JP: startech.com/jp