

# TCL • Roku TV



TCL Home App  
Your TCL Smart Hub.  
Download Now!

User manual

[www.tcl.com](http://www.tcl.com)

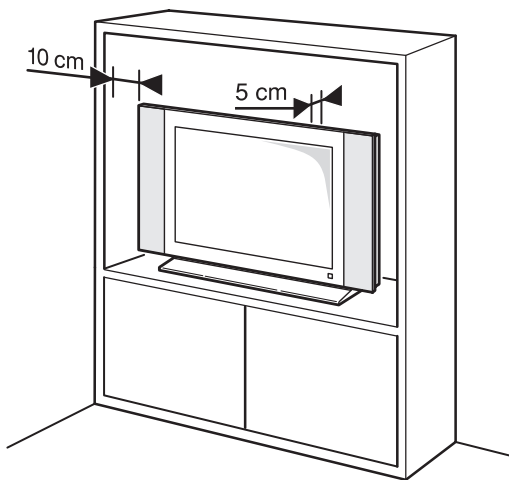
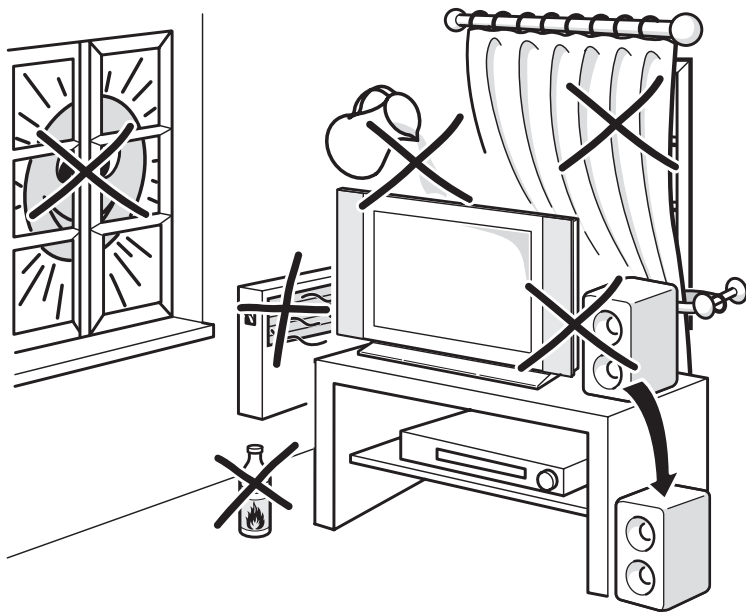

## Safety

Ensure that your domestic mains supply voltage matches the voltage indicated on the identification sticker located at the back of your set. Where the mains plug, AC inlet or an appliance coupler is used as disconnect device, it shall remain readily operable.

On certain models, the light indicator is located at the side of the TV set. The absence of a light indication at the front does not mean that the TV set is fully disconnected from the mains. To disconnect the TV set completely, the mains plug must be pulled out.

The TV set's components are sensitive to heat. The **maximum ambient temperature** should not exceed **35° Celsius**. Do not cover the vents at the back or sides of the TV set. Leave sufficient space around it to allow adequate ventilation. Install the appliance away from any source of heat (fireplace, etc.) or appliances creating strong magnetic or electric fields.

**Moisture** in rooms where the set is installed should not exceed **75% humidity**. Moving the set from a cold place to a warm one can cause condensation on the screen (and on some components inside the TV set). Let the condensation evaporate before switching the TV set on again.

The  $\odot$  or **POWER**/ $\odot$  button on the TV set or the  $\odot$  button on the remote control can be used to switch it on and put it into standby mode. If you are **not going to be watching the TV for a lengthy period of time**, switch it off completely by removing the plug from the mains power socket.

During **thunderstorms**, we recommend that you disconnect the TV set from the mains and antenna so that it is not affected by electrical or electromagnetic surges that could damage it. For this reason, keep the **mains and antenna sockets** accessible so they can be **disconnected**, if necessary.

**Unplug** the TV set immediately if you notice it giving off a **smell of burning** or **smoke**. You must never, under any circumstances, open the TV set yourself, as you run the risk of an **electric shock** in doing so.

## WARNINGS

This appliance is intended for domestic household use only and should not be used for any other application, such as for non-domestic use or in a commercial environment.

If the external flexible cable or cord of this product is damaged, it shall be replaced by the manufacturer or his service agent or a similar qualified person in order to avoid a hazard.

Leave more than 10cm clearance around the television to allow adequate ventilation. The ventilation should not be impeded by covering the ventilation openings with items, such as newspapers, table-cloths, curtains, etc.

The apparatus shall not be exposed to dripping or splashing and no objects filled with liquids, such as vases shall be placed on the apparatus.

Batteries (battery pack or batteries installed) shall not be exposed to excessive heat such as sunshine, fire or the like.

To reduce the risk of fire or electric shock, do not expose this apparatus to rain or moisture.

A television set may fall, causing serious personal injury or death. Many injuries, particularly to children, can be avoided by taking simple precautions such as:

- ALWAYS use cabinets or stands or mounting methods recommended by the manufacturer of the television set.
- ALWAYS use furniture that can safely support the television set.
- ALWAYS ensure the television set is not overhanging the edge of the supporting furniture.
- ALWAYS educate children about the dangers of climbing on furniture to reach the television set or its controls.
- ALWAYS route cords and cables connected to your television so they cannot be tripped over, pulled or grabbed.
- NEVER place a television set in an unstable location.
- NEVER place the television set on tall furniture (for example, cupboards or bookcases) without anchoring both the furniture and the television set to a suitable support.
- NEVER place the television set on cloth or other materials that may be located between the television set and supporting furniture.
- NEVER place items that might tempt children to climb, such as toys and remote controls, on the top of the television or furniture on which the television is placed.

If the existing television set is going to be retained and relocated, the same considerations as above should be applied.

Equipment with this symbol is a Class II or double insulated electrical appliance.

It has been designed in such a way that it does not require a safety connection to electrical earth.



Equipment without this symbol is a Class I electrical appliance. It shall be connected to a mains socket outlet with a protective earthing connection.



To prevent the spread of fire, keep candles or other open flames away from this product at all times.



This symbol indicates that high voltage is present inside. It is dangerous to make any kind of contact with any internal part of this product.



This symbol indicates that the fuse may be in the neutral, and that the mains shall be disconnected to de-energize the phase conductors.

To prevent injury, this apparatus must be securely attached to the floor/wall in accordance with the installation instructions.

To reduce the risk of RF exposure, the use distance of this apparatus should be at least 100cm.

If an outside antenna or cable system is connected to the product, be sure the antenna or cable system is grounded by a skilled person so as to provide some protection against voltage surges and built-up static charges.

**TV screen**

The TV screen used in this product is made of glass. Therefore, it can break when the product is dropped or impacted upon by other objects.

The TV screen is a very high technology product, giving you finely detailed pictures. Occasionally, a few nonactive pixels may appear on the screen as a fixed point of blue, green or red. This does not affect the performance of your product.

**Care**

Use a glass-cleaning product to clean the screen and a soft cloth and mild detergent to clean the rest of the set.

**Important:** Using strong detergents, alcohol-based and abrasive products may damage the screen.

Dust the vents at the back and sides regularly. Using solvents, abrasive or alcohol-based products could damage the TV set. If an object or liquid enters the appliance, unplug it immediately and have it checked by an authorized engineer. Never open the appliance yourself since this may put you at risk or damage the appliance.

**ESD regulation** 

This apparatus meets ESD performance criteria. In case the apparatus does not recover in Ethernet connection mode or USB playing mode due to electrostatic discharge, user intervention is required.

**Hanging the TV set on the wall**

**Warning: This operation requires two people.**

To ensure a safe installation, observe the following safety notes:

- Check that the wall can support the weight of the TV set and wall mount assembly.
- Follow the mounting instructions provided with the wall mount. For certain models, make sure to screw the hexagonal VESA wall mounting screw bosses (and screws) provided with the set into the nuts for the wall mount at the back of your set before your wall mounting.
- The TV set must be installed on a vertical wall.
- Make sure to use only screws suitable for the material of the wall.
- Make sure that the TV set cables are placed so that there is no danger of tripping over them.

All other safety instructions about our TV sets are also applicable here.

**Multi product user manual**

The features described in this manual are common to most models. Some features may not be available on your TV and/or your TV may include features that are not described in this user manual. The illustrations in this manual may differ from the actual product. Please refer to the actual product.

**Information for Users on Disposal of Old Equipment and Batteries****[European Union]**

These symbols indicate that the electrical and electronic equipment and the battery with this symbol should not be disposed of as general household waste at their end-of-life. Instead, the products should be handed over to the applicable collection points for the recycling of electrical and electronic equipment as well as batteries for proper treatment, recovery and recycling in accordance with your national legislation and the Directive 2012/19/EU, 2006/66/EC and 2008/12/EC.



By disposing of these products correctly, you will help to conserve natural resources and will help to prevent potential negative effects on the environment and human health which could otherwise be caused by inappropriate waste handling of these products.

For more information about collection points and recycling of these products, please contact your local municipal office, your household waste disposal service or the shop where you purchased the product.

Penalties may be applicable for incorrect disposal of this waste, in accordance with national legislation.

**[Business users]**

If you wish to dispose of this product, please contact your supplier and check the terms and conditions of the purchase contract.

**[Other Countries outside the European Union]**

These symbols are only valid in the European Union. If you wish to dispose of these items, please do so in accordance with applicable national legislation or other rules in your country for the treatment of old electrical equipment and batteries.

**Statement of Compliance:****2023 No. 1007 The Product Security and Telecommunications Infrastructure (Security Requirements for Relevant Connectable Products) Regulations 2023**

The product is in compliance with the following standard(s) or normative document(s):

**ETSI EN 303 645 V2.1.1:2020-06**

Provision 5.1-1  
Provision 5.1-2  
Provision 5.2-1  
Provision 5.3-13

The full text of the UK declaration of conformity is available at the following internet address: [www.tcl.com](http://www.tcl.com). Choose the model name and go to **DOWNLOADS**.

**Declaration of Conformity**

Hereby, TCL declares that the radio equipment type TV is in compliance with Directive 2014/53/EU. The full text of the EU declaration of conformity is available at the following internet address: [www.tcl.com](http://www.tcl.com). Choose the model name and go to **DOWNLOADS**.

Manufacturer: TCL King Electrical Appliances(Huizhou) Co., Ltd.  
78#, 4th Huifeng Road, ZhongKai New & High-tech Industries  
Development Zone, Huizhou, Guangdong, China 516006

Email address: [ukeee@tcl.com](mailto:ukeee@tcl.com)



Applies to products intended for the UK market.

Hereby, TCL declares that the radio equipment type TV is in compliance with the relevant UK statutory requirements. The full text of the UK declaration of conformity is available at the following internet address: [www.tcl.com](http://www.tcl.com). Choose the model name and go to **DOWNLOADS**.

UK Importer: TCL Electronics UK Limited,  
1 Brunel Way, Slough,  
United Kingdom, SL1 1FQ

*Figures and illustrations in this User Manual are provided for reference only and may differ from actual product appearance. Product design and specifications may be changed without notice.*

Important information ..... 3

**Chapter 1 - Connections**

Connect the power and antenna ..... 7

Connect Blu-ray Disc player, game console, HD camcorder, headphones, CI module ..... 7

Connect to the Internet ..... 8

**Chapter 2 - Getting started**

Remote control functions ..... 9

    Installing batteries ..... 9

Power button ..... 10

Switch the TV on and off ..... 10

Initial setup ..... 10

Activate your TCL Roku TV ..... 11

How to set up your Roku TV ..... 11

Roku mobile app ..... 11

**Chapter 3 - Basic TV operations**

Accessing broadcast channels ..... 12

Watching connected devices ..... 12

Adjusting volume ..... 12

Accessing TCL Roku TV Home screen ..... 12

Using Settings menu ..... 12

Using the Reset button ..... 12

**Chapter 4 - Using more of your TV**

Scanning for broadcast channels ..... 13

Using Subtitles ..... 13

    Turning on/off Subtitles ..... 13

    Set Subtitle preferred language ..... 13

    Turning on/off Hard of hearing ..... 13

Control other devices (CEC) ..... 13

    Enabling or disabling CEC ..... 13

    Using One-touch play ..... 13

    Using System standby ..... 13

HbbTV ..... 13

    HbbTV access ..... 14

    HbbTV deactivation ..... 14

Software updates ..... 14

Reset to factory default settings ..... 14

Viewing pictures, playing music, and watching videos from a USB storage device ..... 14

**Chapter 5 - Other information**

Password in Parental Controls ..... 15

Troubleshooting ..... 15

# Chapter 1 - Connections

## Connect the power and antenna

To switch on TV after connecting power cord, press  $\text{⏻}$  or **POWER/⏻**.

Notes:

- Position of power socket varies according to TV model.
- Disconnect the power cord before connecting devices.

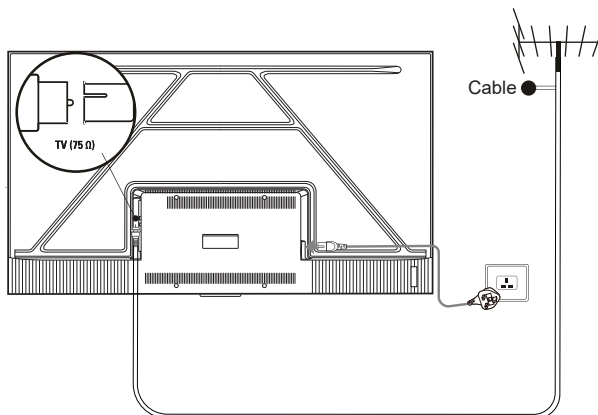

## Connect Blu-ray Disc player, game console, HD camcorder, headphones, CI module

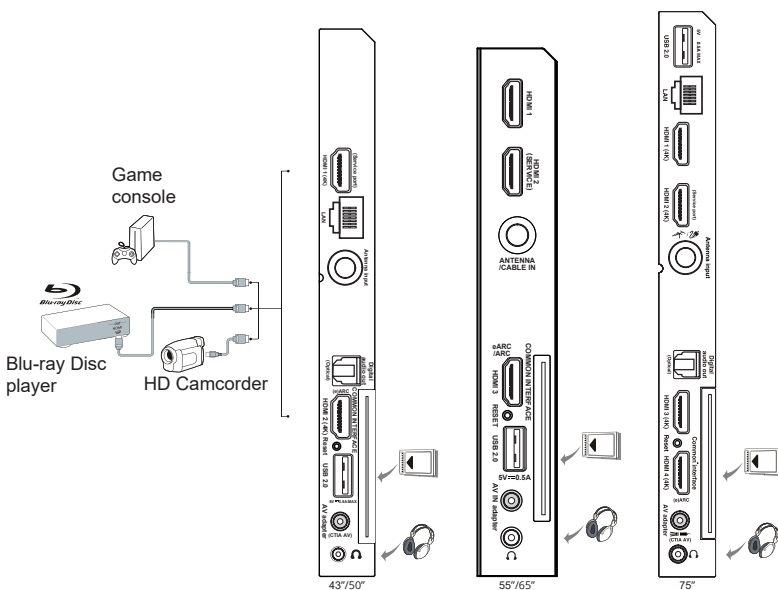

Notes:

- CABLE IN is not supported

## Connect to the Internet

*Note: The following instructions are just the usual ways to connect your TV to the wireless network. The connection method may be different depending on your actual network configuration. If you have any questions about your home network, please refer to your Internet service provider.*

### Wireless connection

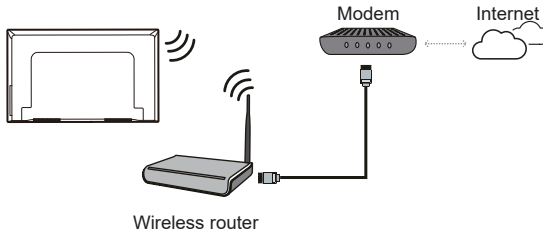

#### Notes:









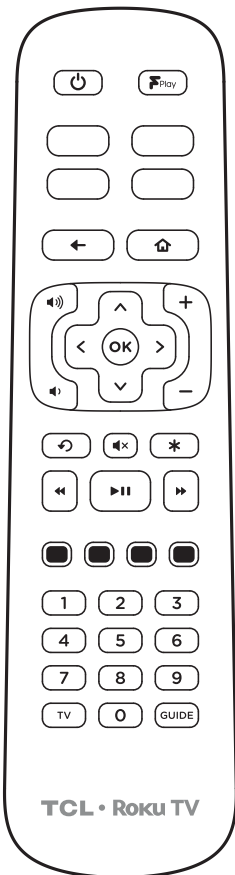





- Your TV might not have all connectors visible on diagram above. Number of USB and HDMI ports may vary according to TV model.
- Button and connector locations may vary according to TV model.
- USB connectors are for data input from USB drives and for connecting other relevant USB devices where applicable.
- All USB devices have to be directly connected to TV set without cable extenders. In case extender is required, maximum 50cm length is recommended. Longer extenders should have ferrite beads.
- ARC (Audio Return Channel) function is only supported on the HDMI port identified with ARC.
- It is recommended to use high quality and well shielded HDMI cables to avoid possible interference.
- Please use headphones with 3.5mm TRS connector. Excessive sound pressure from headphones can cause hearing loss.
- PCMCIA does not support decryption.



## Remote control functions

Most of your television's functions are available via the menus that appear on the screen. The remote control supplied with your set can be used to navigate through the menus and to configure all the general settings.



-  **STANDBY** -- Turns TV on and off.  
Note: The TV will be in active standby for about 15 minutes after it is switched off with the ON/OFF button. After this time, the TV will go into passive standby mode. When you press the ON/OFF button to turn on the TV, the TV will turn back on immediately if it is in active standby or it will take a few seconds longer if it is in passive standby.
-  **FREEVIEW PLAY** -- Accesses Freeview Play.
-  **APPS KEYS** **APPS KEYS** -- Accesses specific applications quickly and directly.  
Dedicated buttons vary by model and region.
-  **BACK.**  
Menu: Goes back to previous menu/screen.  
Watching any TV input: Returns to Home screen.
-  **HOME** -- Immediately returns to the Home screen.
-  **VOLUME UP / DOWN** -- Increases and decreases the volume.
-  **DIRECTIONAL PAD.** Navigates the TV menus and options:  
- **LEFT/RIGHT/UP/DOWN** moves the highlight in the corresponding direction.  
- **OK** selects the highlighted option.
-  **CHANNEL UP / DOWN** -- Changes to the next or previous channel in the channel list. Scrolls through lists one page at a time.
-  **REPLAY** -- Returns to the previously viewed TV channel.
-  **MUTE** -- Mutes and unmutes TV sound.
-  **STAR** -- Displays additional options when available. On-screen hints let you know when this button is active.
-  **REWIND** -- Plays in fast rewind mode.
-  **PLAY / PAUSE** -- Plays or pauses media.
-  **FAST FWD** -- Plays in fast forward mode.
-  **COLOUR KEYS** -- Function depends on Interactive TV app being used.
- 0-9** **NUMBER KEYS** -- Live TV: Direct channel entry.  
On-screen number pad: Direct number entry.
- TV** **TV** -- Jumps directly to Live TV. Exits an interactive TV app.
- GUIDE** **GUIDE** -- Displays the program guide.

### Installing batteries

1. Push to open the back cover of the remote.
2. Insert batteries according to the polarities marked on the batteries case.
3. Replace the back cover.

*Note: The remote control type may be changed without notice.*

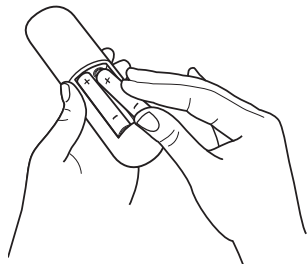

**Important:**

Batteries shall not be exposed to excessive heat such as sunshine, fire or the like. Remove batteries when the remote control is not to be used for a long time. Batteries left in equipment may cause damage through deterioration and corrosive leakage, invalidating the guarantee.

To protect the environment use local recycling facilities for battery disposal. Dispose of used batteries according to the instructions.

**CAUTION:** Risk of explosion if batteries are replaced by an incorrect type. Replace only with the same or equivalent type recommended by the equipment manufacturer.

If the batteries in your remote control are run down, you can use the  button on the set to turn on and off your TV set.

**Power button**

*Note: The picture is only for reference.*



## ■ In standby mode:

Short press Power button to turn on the TV.

## ■ In working status:

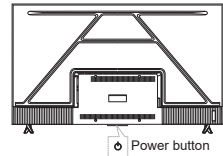
- Long press Power button and the TV will be in active standby for about 15 minutes. The TV will enter passive standby after this time. Press Power button to turn on the TV, the TV will resume instantly if in active standby or will take few seconds longer if in passive standby.
- Short press Power button to open the Inputs menu, then you can short press Power button to cycle through all items in the order as they are displayed in the Inputs menu.
  - **Close:** Exit the Inputs menu.
  - **Turn off TV:** Turn the TV to standby mode.
  - **Blu-ray Player:** Access the external device connected through HDMI or AV terminal.
  - **Live TV:** Access the Live TV mode.
  - **Home:** Return to Home screen.

**Switch the TV on and off**

1. When the power cord is connected, the TV will be turned on directly or be in standby mode. If the TV is in standby mode, press the  button on the set or the  button on the remote control to turn it on.
2. To put the TV into standby mode, press the  button on the remote control. The TV set remains powered up, but with low energy consumption.
3. To switch the TV off, unplug the mains plug from the mains outlet.

**Initial setup**

The first time you switch the set on, the **Let's get started** screen appears, which guides you through the initial setup process. Follow the on-screen instructions to finish the initial setup process such as selecting the language, connecting to the network and more. During each step, either make a choice or skip the step. If you skip a step, you can perform the setup later from the settings menu.

## Activate your TCL Roku TV

Activate your TCL Roku TV using your computer, smartphone, or tablet to link to a Roku account. You need a Roku account to activate your TV and access entertainment across thousands of free and paid streaming channels.

Roku doesn't charge for activation support - beware of scams.

Roku accounts are free and while a valid credit card number is not required to create a Roku account, saving your credit card information makes renting, purchasing, and subscribing to entertainment from the Roku Channel Store fast and convenient.

Once connected to your account, your TV will automatically update with the latest software, and you can start streaming immediately.

If you aren't ready to connect your TV to the internet, you can still use it as a regular TV.



## How to set up your Roku TV

You can find the Roku TV user guide and more details on setting up the TV by scanning the QR code below or by following the link:

<https://go.roku.com/tvmanual>



## Roku® mobile app

To control your Roku device with the Roku mobile app, you must connect your mobile device to the same wireless network as your Roku device. Visit the App Store to download the Roku mobile app for iOS.

The Roku App (Official) on the App Store ([apple.com](https://apple.com))



The Roku App (Official) on Google Play





### Accessing broadcast channels

**Using the numeric buttons:** press the corresponding numeric buttons on the remote control to access broadcast channels.



**Using the +/- buttons:** press the +/- buttons on the remote control to scroll through the channels.

### Watching connected devices

Press  on the remote control to display the home screen, and press **OK/➤** to enter the source list. Press  to select TV or other input sources and press **OK** to confirm.

### Adjusting volume

**Volume control:** press the  buttons on the remote control to increase or decrease the volume.



**Sound mute:** press the  button to temporarily mute the sound. Press this button again or the  button to restore the sound.

### Accessing TCL Roku TV Home screen

Allows you to enjoy thousands of streaming channels, and adjust the system settings for your TV. You can use the remote control to navigate around the home screen.





#### WARNING:

- Configure the network settings to get the most out of your TCL Roku TV.
- Slow responses and/or interruptions may occur, depending on your network conditions.

1. Press  on the remote control to display the **TCL Roku TV** home screen.
2. Press  and **OK** to enter the desired functions or settings.
3. Press  to return to the home screen.



### Using Settings menu

Allows you to adjust TV settings, such as picture and sound.

1. Press  on the remote control to display the home screen and press  to select the **Settings** option. Then press **OK/➤** to enter.
2. Press  to select the desired item, then press **OK/➤** to enter the corresponding submenu.
3. In submenus, press  to select menu options, then press **OK/➤** to enter the option list, the adjustment interface, or the corresponding submenu.
4. Press  to return to the previous menu.

5. Press  to exit the menu.

#### Note:

- You can also press  on the remote control, select **Options** (if available) and press  to select menu options, then press  to enter the adjustment of picture and audio.

### Using the Reset button

- Press once to restart the TV.
- Press and hold for factory reset, and careful, you will lose all your settings!

## Scanning for broadcast channels



This section describes how to scan for broadcast channels automatically. This may be done in any of the cases below:

- you are prompted that there are no broadcast channels in TV mode;
  - you want to update your broadcast channels.
1. In TV mode, press  on the remote control and select **Settings > TV inputs > Live TV > Scan for channels > Start finding channels**.
  2. Press **OK** to start finding channels.



## Using Subtitles

You can enable subtitles for each TV channel. Subtitles are broadcast via DVB-T/T2 digital broadcasts. With digital broadcasts, you have the additional option of selecting a preferred subtitle language.



### Turning on/off Subtitles

1. Press  on the remote control, select **Settings > Accessibility > Subtitles mode** and press **OK/>** to enter.
2. Select the **Off/On always/On replay/On mute** option, and press **OK** to disable/enable this function.
3. Press  to close the menu.

### Set Subtitle preferred language

1. Press  on the remote control, select **Settings > Accessibility > Subtitles preferred language** and press **OK/>** to enter.
2. Press  select a subtitle language as your preferred language and press **OK** to confirm.
3. Press  to close the menu.



### Turning on/off Hard of hearing

1. Press  on the remote control, select **Settings > Accessibility > Hard of hearing** and press **OK/>** to enter.
2. Select the **On/Off** option, and press **OK** to enable/disable this function.
3. Press  to close the menu.

## Control other devices (CEC)

Use this function to search for CEC devices connected to the HDMI sockets in your TV and enable one-touch play and one-touch standby between CEC devices.

### Enabling or disabling CEC

1. Press  on the remote control, select **Settings > System > Control other devices (CEC)** and press **OK/>** to enter.
2. Select the **One-touch play/System standby** option, and press **OK** to enable/disable the option.
3. Press  to close the menu.

### Using One-touch play

Enables other devices to automatically switch the TV to use it as the active source/input when playback starts. Press **OK** to turn it on to enable this function.

### Using System standby

Enables all CEC devices to automatically go to the standby mode when your TV goes to standby mode. Press **OK** to enable this function.

*Note: The CEC functions depend on the devices connected and it is possible that some devices may not interoperate correctly when connected to this TV. The user manual or the manufacturer of the problematic devices should be consulted for further information.*

## HbbTV

HbbTV (Hybrid broadcast broadband TV) is a service offered by certain broadcasters and available only on some digital TV channels. HbbTV delivers interactive television over broadband Internet. These interactive features are added to and enrich the normal digital programmes, and include services such as digital teletext, electronic programme guide, games, voting, specific information related to the current programme, interactive advertising, information magazines, catch-up TV, etc.

To use HbbTV please ensure your TV is connected to Internet and HbbTV is switched on.

*Notes:*

- *HbbTV services are broadcast- or country-dependent and may be unavailable in your area.*
- *You cannot download files to your TV with HbbTV function.*
- *Application provider or broadcasting related conditions may cause an HbbTV application to be unavailable temporarily.*
- *To access HbbTV applications you must connect your TV to the Internet via a broadband link. HbbTV applications may not work correctly in case of network related issues.*

## HbbTV access

1. Press **Home** on the remote control, select **Settings > TV inputs > Live TV > HbbTV** and press **OK/➤** to enter.
2. Select the **Enable 'HbbTV'** option, and press **OK** to enable the function.
3. When you tune to a digital TV channel that offers HbbTV, this will be signalled to you by an on-screen indication (generally a red button, but other colour buttons may also be used). Press the indicated colour button to open the interactive pages.
4. Use **↖/↗/↙/↘** and the colour buttons to navigate through the HbbTV pages and press **OK** to confirm.

## HbbTV deactivation

To avoid disturbances that may be caused by HbbTV broadcasting tests, you can turn off the HbbTV function:

1. Press **Home** on the remote control, select **Settings > TV inputs > Live TV > HbbTV** and press **OK/➤** to enter.
2. Select the **Enable 'HbbTV'** option, and press **OK** to turn it off to disable it.

## Software updates

*Notes:*

- Do not switch off or unplug the TV until the upgrade is completed.
- Ensure your network connection remains stable during the upgrade.

Press **Home** on the remote control, select **Settings > System > Software update** and press **OK** to enter. Follow the on-screen instructions to complete the progress.

## Reset to factory default settings

Allows you to reset the TV to factory default settings.

1. Press **Home** on the remote control, select **Settings > System > Advanced system settings > Factory reset > Factory reset everything** and press **OK** to enter.
2. Use the numeric buttons on the remote control to enter the random code that the system provided below the input screen.
3. Select **Start factory reset** and press **OK** to confirm.
4. The **Let's get started** screen appears. Follow the instructions in the section **Initial setup**.

## Viewing pictures, playing music, and watching videos from a USB storage device

Your TV is fitted with USB connectors that enable you to view pictures, listen to music or watch videos stored on USB drives.

When a USB device is connected, follow the on-screen instructions. You can also select the **USB Media Player** app via the **TCL Roku TV** home screen to enter.

*Notes:*

- Some USB keys and USB products like digital cameras or mobile phones are not fully compatible with USB standard so they may not work with the TV media player. Not all USB keys or devices are compatible with the USB function. Not all file formats are recognised. The encoding formats of your files will determine whether or not they can be played.
- Please use high speed (minimum 5MB/s read transfer) USB drives.

## Password in Parental Controls

- If no PIN has been set, users must specify a PIN before accessing the parental control settings.
- If a PIN has been set, users must enter the correct PIN before accessing the parental control settings.

## Troubleshooting

Please check the following list before requesting service.

### There is no picture or sound.

- Make sure the power cord is properly inserted in the power outlet.
- Make sure the source type is set correctly.
- Make sure the antenna is properly connected.
- Make sure the volume is not set to minimum or the sound is not set to mute.
- Make sure the headphones are not connected.
- The TV may be receiving a signal other than from TV broadcasting stations.
- HDR is supported with streaming content or over USB and HDMI.

### Picture is not clear.

- Make sure the antenna cable is properly connected.
- Consider whether your TV signal is being properly received.
- Poor picture quality can occur due to a VHS camera, camcorder, or other peripheral being connected at the same time. Switch off one of the other peripherals.
- The 'ghost' or double image may be caused by obstruction to the antenna due to high-rise buildings or hills. Using a highly directional antenna may improve the picture quality.
- The horizontal dotted lines shown on the pictures may be caused by electrical interference, e.g., hair dryer, nearby neon lights, etc. Turn off or remove these.

### Picture is too dark, too light or tinted.

- Check the colour adjustment.
- Check the brightness setting.
- Check the sharpness function.

### Remote control does not work.

- Check the batteries of the remote control.
- Make sure the remote sensor window on the TV front is not under strong fluorescent lighting.
- Try to clean the remote sensor window on the TV front with a soft cloth.

If the above suggestions do not solve your technical issue, please refer to the warranty card for service information.

## Operating Conditions

Temperature 5°C–35°C (41°F–95°F)  
Humidity 20–75% (non-condensing)

## Storage Conditions

Temperature -15°C–45°C (5°F - 113°F)  
Humidity 10–90% (non-condensing)

## Radio Information

- 2.4G Wi-Fi transmitter frequency range: 2400–2483.5MHz
  - 2.4G Wi-Fi transmitter power: 15dBm (±2dB)
  - 5G Wi-Fi transmitter frequency range:
    - Band 1: 5150–5250MHz
    - Band 2: 5250–5350MHz
    - Band 3: 5470–5725MHz
  - 5G Wi-Fi transmitter power: 15dBm (±2dB) for HT20, HT40; 13dBm (±2dB) for HT80
  - DVB-T/T2 tuner frequency range: 474–858MHz
- \* Operation of 5150–5350MHz is restricted to indoor use only.

	BE	BG	CZ	DK	DE	EE	IE
	EL	ES	FR	HR	IT	CY	LV
	LT	LU	HU	MT	NL	AT	PL
	PT	RO	SI	SK	FI	SE	UK (NI)

## OSS Notice

Certain components of the software included with this Roku product are subject to open source licenses, including GPL and LGPL. Pursuant to the open source licenses, as applicable, source code files of the open source software are made available at: <https://www.roku.com/separatelylicensedcode>. The open source software is subject to the terms and conditions of the applicable open source licenses.

## [Legal Statement] of TCL - manufacturer of this TV set

Due to the various capabilities of products featuring the SmartTV - Services, as well as limitations in the available content, certain features, applications, and services may not be available on all devices or in all territories. Some features on SmartTV may also require additional peripheral devices or membership fees that are sold separately. Please visit our website for more information on specific device information and content availability. The services and availability of content through SmartTV are subject to change from time to time without prior notice.

All content and services accessible through this device belong to third parties and are protected by copyright, patent, trademark and/or other intellectual property laws. Such content and services are provided solely for your personal noncommercial use. You may not use any content or services in a manner that has not been authorized by the content owner or service provider. Without limiting the foregoing, unless expressly authorized by the applicable content owner or service provider, you may not modify, copy, republish, upload, post, transmit, translate, sell, create derivative works, exploit, or distribute in any manner or medium any content or services displayed through this device.

YOU EXPRESSLY ACKNOWLEDGE AND AGREE THAT USE OF THE DEVICE IS AT YOUR SOLE RISK AND THAT THE ENTIRE RISK AS TO SATISFACTORY QUALITY, PERFORMANCE AND ACCURACY IS WITH YOU. THE DEVICE AND ALL THIRD PARTY CONTENT AND SERVICES ARE PROVIDED "AS IS" WITHOUT WARRANTY OF ANY KIND, EITHER EXPRESS OR IMPLIED. TCL EXPRESSLY DISCLAIMS ALL WARRANTIES AND CONDITIONS WITH RESPECT TO THE DEVICE AND ANY CONTENT AND SERVICES, EITHER EXPRESS OR IMPLIED, INCLUDING BUT NOT LIMITED TO, WARRANTIES OF MERCHANTABILITY, OF SATISFACTORY QUALITY, FITNESS FOR A PARTICULAR PURPOSE, OF ACCURACY, OF QUIET ENJOYMENT, AND NON-INFRINGEMENT OF THIRD PARTY RIGHTS. TCL DOES NOT GUARANTEE THE ACCURACY, VALIDITY, TIMELINESS, LEGALITY, OR COMPLETENESS OF ANY CONTENT OR SERVICE MADE AVAILABLE THROUGH THIS DEVICE AND DOES NOT WARRANT THAT THE DEVICE, CONTENT OR SERVICES WILL MEET YOUR REQUIREMENTS, OR THAT OPERATION OF THE DEVICE OR SERVICES WILL BE UNINTERRUPTED OR ERROR-FREE. UNDER NO CIRCUMSTANCES, INCLUDING NEGLIGENCE, SHALL TCL BE LIABLE, WHETHER IN CONTRACT OR TORT, FOR ANY DIRECT, INDIRECT, INCIDENTAL, SPECIAL OR CONSEQUENTIAL DAMAGES, ATTORNEY FEES, EXPENSES, OR ANY OTHER DAMAGES ARISING OUT OF, OR IN CONNECTION WITH, ANY INFORMATION CONTAINED IN, OR AS A RESULT OF THE USE OF THE DEVICE, OR ANY CONTENT OR SERVICE ACCESSED BY YOU OR ANY THIRD PARTY, EVEN IF ADVISED OF THE POSSIBILITY OF SUCH DAMAGES.

Third party services may be changed, suspended, removed, terminated or interrupted, or access may be disabled at any time, without notice, and TCL makes no representation or warranty that any content or

service will remain available for any period of time. Content and services are transmitted by third parties by means of networks and transmission facilities over which TCL has no control. Without limiting the generality of this disclaimer, TCL expressly disclaims any responsibility or liability for any change, interruption, disabling, removal of or suspension of any content or service made available through this device. TCL may impose limits on the use of or access to certain services or content, in any case and without notice or liability. TCL is neither responsible nor liable for customer service related to the content and services. Any question or request for service relating to the content or services should be made directly to the respective content and service providers.



## Legal terms of Freeview

Availability of channels and services subject to geographic location, device and coverage. Aerial upgrade and/or receiver may be required. Visit [freeview.co.uk/availability](http://freeview.co.uk/availability).

Minimum broadband speed of 2Mbps required for catch up and on demand services. Watching on demand and catch up programmes will count towards any monthly broadband data allowance.

FREEVIEW words and logos are trademarks of DTV Services LTD. © DTV Services Ltd.



The terms HDMI, HDMI High-Definition Multimedia Interface, HDMI trade dress and the HDMI logos are trademarks or registered trademarks of HDMI License Administrator, Inc.



Dolby, Dolby Vision, Dolby Atmos, and the double-D symbol are registered trademarks of Dolby Laboratories Licensing Corporation. Manufactured under license from Dolby Laboratories. Confidential unpublished works. Copyright © 2012–2022 Dolby Laboratories. All rights reserved.



Roku, Roku TV, the Roku logo, and the purple d-pad design are the trademarks of Roku, Inc. All other trademarks and logos herein are the property of their respective owners.



J0101-000981