

TCL

5.1.2 Channel Dolby Atmos Soundbar with Wireless Subwoofer

Q75H

User Manual



Contents

1 Before you begin	3
---------------------------------	----------

2 Welcome.....	6
-----------------------	----------

What's in the box	6
Overview of the Soundbar	8
Overview of the wireless Subwoofer.....	10
Set up your Soundbar system	11
Position Your Soundbar and Subwoofer.....	11
Mount your Soundbar on the wall.....	12
Install/replace the Remote Control batteries	15
Overview of the Remote Control.....	16

3 Connect your Soundbar system	19
---------------------------------------------	-----------

Connect with the HDMI cable.....	19
TCL Tutti Choral	21
Connect with the optical cable	22
Direction for setting up your Soundbar using an optical cable	23
Connect your Soundbar to power supply.....	24
Connect the Soundbar with your Bluetooth device.....	25
Streaming Audio with Apple AirPlay	27

4 Use your Soundbar system	29
-----------------------------------------	-----------

Use your Soundbar with the top panel or Remote Control	
--------------------------------------------------------	--

.....	29
Listen to music from your Bluetooth device	31
Use the USB cable or device for music playback	32
<hr/>	
5 Software update	33
Online update.....	33
USB update	34
<hr/>	
6 Specifications	36
<hr/>	
7 Notice	38
Declaration of conformity.....	38
Disposal of your old product and battery	38
Statement of Compliance	39
Trademarks	41
<hr/>	
8 FAQ	43

1 Before you begin

- Carefully read and observe all safety instructions in the safety leaflet.
- This Soundbar is intended for indoor use only. In case it accidentally gets in contact with small amounts of water, unplug immediately and use a dry cloth to remove the water.
- Unplug the Soundbar if it is not used for long periods of time or during lightning storms.
- Make sure the Soundbar is installed on a solid surface or solidly wall-mounted below your TV for the best experience.
- Only use AAA 1,5V non-rechargeable batteries for the Remote Control.
- In case any of the cables are visibly damaged or pinched, unplug the Soundbar and replace the cable.
- Be careful not to sharply bend the HDMI and optical cable as they may affect the performance.
- Protect your hearing by adjusting to a proper volume. Predefined and customizable sound settings are available for your listening comfort.

Important safety instructions

Make sure you read all the safety information before you use this product.

TCL Overseas Marketing Limited bears no responsibility for accidents or damages caused by unauthorized changes, modifications or improper use of the product.

User Manual can be found at www.tcl.com on the specific product page in the "Download" section.

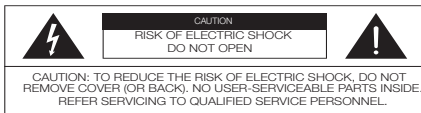

The lightning flash with arrowhead symbol, within an equilateral triangle is intended to alert the user to the presence of uninsulated dangerous voltage within the product's enclosure that may be of sufficient magnitude to constitute a risk of electric shock.



The exclamation point within an equilateral triangle is intended to alert the user to the presence of important operating and maintenance (servicing) instructions in the literature accompanying the product.



This symbol indicates that this product incorporates double insulation between hazardous main voltage and user accessible parts. When servicing, use only identical replacement parts.

Warnings

- To reduce the risk of fire or electric shock, do not expose this product to rain or moisture. This product should not be exposed to dripping or splashing. No objects filled with liquids, such as vases, should be placed on or near the product.
- The product is unstable if it is not properly placed or mounted to the wall. Be sure to follow the wall mounting instructions provided in the user manual to ensure your safety.
- Do not expose batteries to excessive heat such as sunshine, fire, and so forth.
- To avoid the danger of suffocation, keep plastic packaging away from pets, babies, and children. Do not use packaging bags in cribs, beds, carriages, or playpens.
- Shielded cables must be used with this unit to ensure compliance with the Class B FCC limits.

Safety

- **Read these instructions** - Read all the safety and operating instructions before operating the product.
- **Retain these instructions** - Retain the safety and operating instructions for future reference.
- **Heed all warnings** - Adhere to all warnings on the product and in the operating instructions.
- **Follow all instructions** - Follow all operating and use instructions.
- **Do not use this apparatus near water** - The appliance should not be used near water or moisture – for example, in a wet basement or near a swimming pool and the like.
- **Clean only with a dry cloth.**
- **Do not block any ventilation openings.** Install in accordance with the manufacturer's instructions.
- **Do not install near any heat sources** such as radiators, heat registers, stoves, or other apparatus (including amplifiers) that produce heat.
- **Do not defeat the safety purpose** of the polarized or grounding-type plug. A polarized plug has two blades with one wider than the other. A grounding type plug has two blades and a third grounding prong. The wide blade or the third prong are provided for your safety. If the provided plug does not fit into your outlet, consult an electrician for replacement of the obsolete outlet.
- **Protect the power cord** from being walked on or pinched particularly at plugs, convenience receptacles, and the point where it exits from the product. If the cord set is damaged, it must be replaced by a special cord set available from the manufacturer or its service agent.
- **Use only attachments/accessories** specified by the manufacturer.
- **Use only with the cart, stand, tripod, bracket, or table** specified by the manufacturer, or sold with the apparatus. When a cart is used, use caution when moving the cart/apparatus combination to avoid injury from tip-over.



- **Unplug this apparatus** during lightning storms or when unused for long periods of time.
- **Refer all servicing** to qualified service personnel. Servicing is required when the apparatus has been damaged in any way, such as power-supply cord or plug damaged, liquid has been spilled or objects have fallen into the apparatus, the apparatus has been exposed to rain or moisture, does not operate normally, or has been dropped.
- **The user must maintain** a minimum distance of 20cm from the device at all time.
- **This appliance is not intended** for use by young children or infirm persons without supervision. Young children should be supervised to ensure that they do not play with the appliance.

Cautions

- To prevent electric shock, match wide blade of plug to wide slot, fully insert.
- Do not place any sources of danger on the product (for example: liquid filled objects, lighted candles).
- Disconnect the power cord to shut off when find trouble or not in use. The power cord shall be readily operable.
- Use of controls or adjustments or performance of procedures other than those described herein, may result in hazardous radiation exposure or other unsafe operation.
- The power cord/appliance coupler is used as the disconnect device, the disconnect device must remain readily operable.
- The rating label is located at the bottom or back of the product.
- The use of apparatus in tropical and moderate climates.

Battery precautions

- Do not mix batteries (old and new or carbon and alkaline).
- Do not dispose of batteries in fire or water.
- Recycle or dispose of batteries as per state and local guidelines.
- Danger of explosion if battery is incorrectly replaced. Replace only with the same or equivalent type.
- When the remote control is not to be used for a long time (more than a month), remove the battery from the remote control to prevent it from leaking.
- If the batteries leak, wipe away the leakage inside the battery compartment and replace the batteries with new ones.
- Keep away the batteries from heat or moisture.
- Do not carry or store batteries with other metallic objects. Doing so could cause batteries to short circuit, leak or explode.
- Never recharge a battery unless it is confirmed to be a rechargeable type.
- If the battery compartment does not close securely, stop using the product and keep it away from children.

Disposal of your old product and battery

Your product is designed and manufactured with high quality materials and components, which can be recycled and reused.

This product may contain lead and mercury. Disposal of these materials may be regulated due to environmental considerations. For disposal or recycling information, please contact your local authorities.

This product contains batteries:

- Do not incinerate. Batteries may explode if overheated.
- For disposal or recycling information, please contact your local authorities.

CAUTION: Risk of explosion if the battery is replaced by an incorrect type.

CAUTION: Replacement of a battery with an incorrect type that can defeat a safeguard.

CAUTION: Disposal of a battery into fire or a hot oven, or mechanically crushing or cutting of a battery, that can result in an explosion.

CAUTION: Leaving a battery in an extremely high temperature surrounding environment that can result in an explosion or the leakage of flammable liquid or gas.

CAUTION: A battery subjected to extremely low air pressure that may result in an explosion or the leakage of flammable liquid or gas.

2 Welcome

Congratulations on the purchase of your new TCL Soundbar! After it is set up and connected, you can experience a superb sound quality and state-of-the-art design to best fit your home entertainment system. You are recommended to read through this user manual which helps you set up, connect and operate the product easily and properly.

Let's get started.

What's in the box



Soundbar

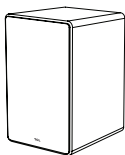

Subwoofer

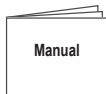

Manual

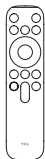

Remote control



AC Power cord x 2

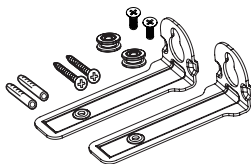

Wall Mount Kit
(for Soundbar)

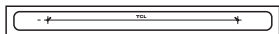



Wall mount template

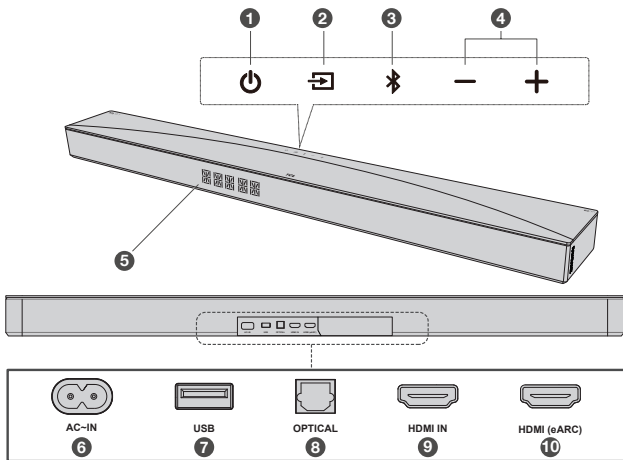

Warranty card

Overview of the Soundbar



- 1 

Short Press: Power on

Long Press: Power off
- 2 

Short Press: Switch input sources (HDMI eARC/Optical/USB/Bluetooth/HDMI IN)

Long Press: Enter subwoofer pairing (If Subwoofer disconnected)
- 3 

Short Press: Select Bluetooth mode

Long Press: Bluetooth pairing

4 — / +

Press to increase or decrease the volume level

5 **LED Display**

Indicates the current status and IR signal from the remote control.

Receive signal from the remote control.

6 **AC input power connector**

7 **USB Type A connector**

8 **Optical input connector**

9 **HDMI IN connector**

10 **HDMI eARC connector**

Note:

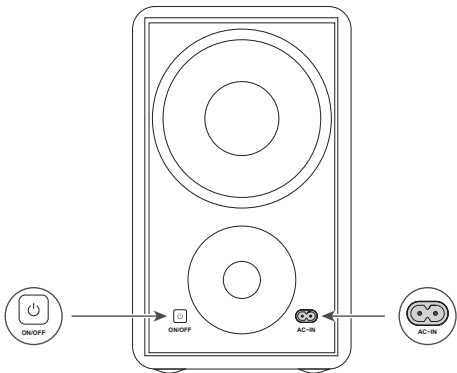

- **Factory Reset:** Long Press three keys (⏻), + and — on the Soundbar panel together for 10s simultaneously till the LED display shows "FACTORY RESET" and then power cycle automatically.

Overview of the wireless Subwoofer



Wireless Subwoofer

THE SUBWOOFER WILL PAIR AUTOMATICALLY WITH SOUNDBAR UPON THE FIRST USE. In case of a problem, take the following steps to manually pair:

1. Press and hold the  button on the Subwoofer for 3 seconds until an amber light begins flashing on the  button.
2. Press and hold the  button on the Soundbar for 10 seconds until the LED display shows "SETUP PAIR" on the Soundbar.
3. After a short while, the Subwoofer LED will turn solid. The Subwoofer is now connected to the Soundbar.

Set up your Soundbar system

Notes

- Make sure you read all the safety information before you mount the Soundbar on the wall.
- Make sure you use screws provided or specified by the authorized manufacturer.
- TCL bears no responsibility for accidents or damage caused by improper wall mounting and screws installation or insufficient wall strength, etc.
- Additional tools (not supplied) are required for installation.
- You can choose to place your Soundbar below the center of your TV or mount it on the wall.

Position Your Soundbar and Subwoofer

The ideal place to position the Soundbar is centered underneath your TV.

You are recommended to place the Soundbar on the top of the cabinet and right below the center of your TV.

The distance between the Subwoofer and the Soundbar should be less than 3 meters.

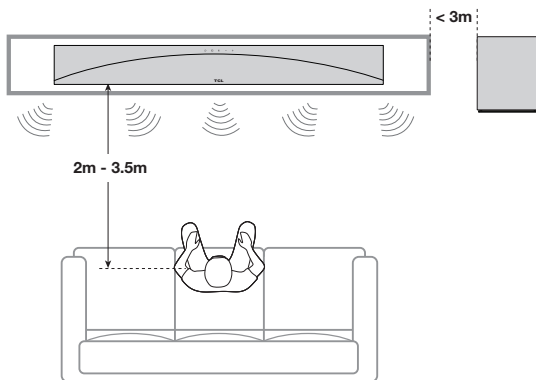

Mount your Soundbar on the wall

- 1 Place the supplied wall mount template on the wall.
Make sure the wall mount template is at least 5cm below the center of the TV.
- 2 Use a level to make sure the wall mount template is positioned accurately.
- 3 Use tape to adhere the wall mount template firmly on the wall.

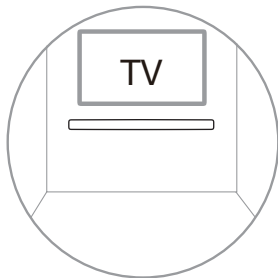

- 4 Locate the mounting holes on the template and mark the wall.
- 5 Remove the wall mount template.
- 6 Drill a screw hole at each marking on the wall.

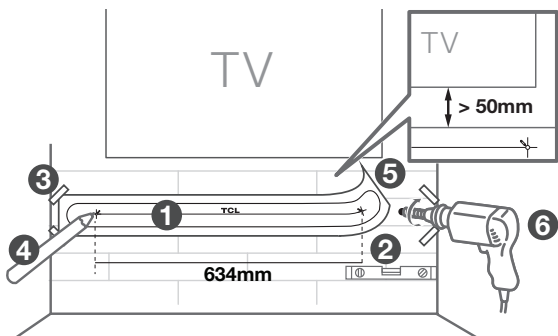

- 7 Insert the wall anchors in the holes on the wall.
- 8 Insert the supplied screws with the wall brackets into the hole of the wall anchors.
- 9 Tighten the screws into the wall.
- 10 Place the bracket and tighten the screw.
- 11 Pick up the soundbar and attach it to the wall screws, similar to how you would hang a picture. Make sure everything is tight.

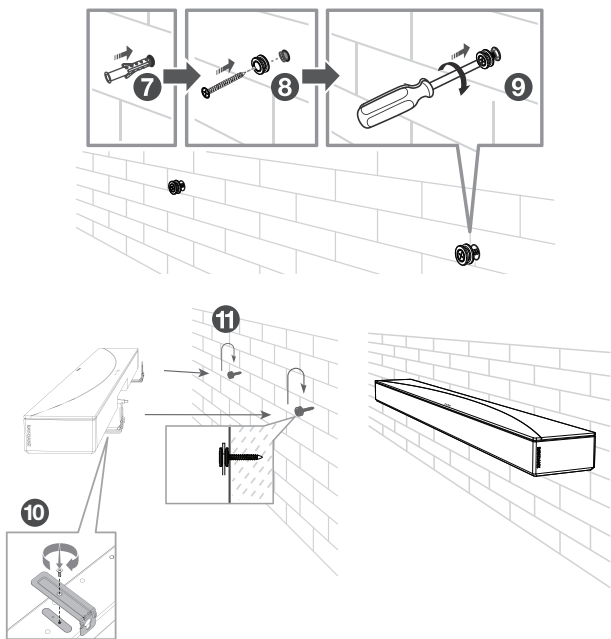

Notes

- Do not place your Soundbar in a location exposed to direct sunlight, heat, fire, or moisture. Only suitable for mounting at heights: < 200cm.

Install/replace the Remote Control batteries

Warnings

- *Danger of explosion if the battery is incorrectly replaced. Replace only with the same or equivalent type.*

Caution

- The battery contains perchlorate material, handle it with care. For information, refer to www.dtsc.ca.gov/hazardouswaste/perchlorate
- 1 Open the battery compartment, remove the old batteries if necessary.
 - 2 Place two new AAA batteries into the battery compartment with the correct polarity (+/-).
 - 3 Close the battery compartment.

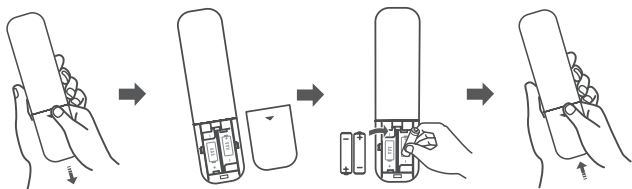

Setup is complete. Your Soundbar is ready to use. For more information about how to access different connection options on your Soundbar, see the following chapter.

Overview of the Remote Control

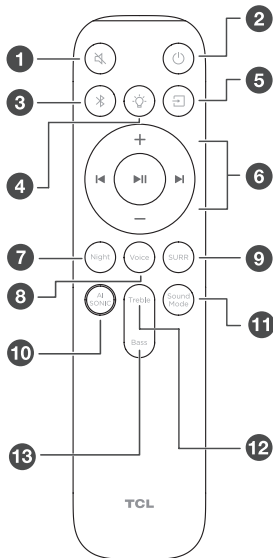

- 1 Short Press: Mute/Unmute the sound
- 2 Short Press: Power on
Long Press: Power off
- 3 Short Press: Select Bluetooth mode
Long Press: Bluetooth Pairing
- 4 Short Press: Change different brightness levels of the LED display
Long Press: Switch between LED light on or turn off
- 5 Short Press: Switch input sources
HDMI eARC/Optical/USB/Bluetooth/HDMI IN

- ⑥ + Increase volume
- Decrease volume
◀ Play previous music
▶ Play next music
▶|| Play/Pause music
- ⑦ Press to switch Night Mode ON or OFF
- ⑧ Press to switch Voice Enhance Mode ON or OFF
- ⑨ Press to switch Surround Enhance Mode ON or OFF
- ⑩ Short press to enter AI Sonic-Adaptation Menu
Short press + / - to switch different AI Sonic-Adaptation:
Position 1/Position 2/Position 3/OFF
- ⑪ Short Press: Switch input sound mode
Standard/Movie/Music/Voice/Game/Sports
- ⑫ Short press to adjust the treble sound effect
Increase or decrease treble with + / - button
- ⑬ Short press to adjust the bass sound effect
Increase or decrease bass with + / - button

This Soundbar can be fully controlled via the TCL Home App, including power, volume, input switching, effects, AI Sonic-Adaptation and more. Use the TCL Home App to explore additional smart features.

Please download the latest version from the app stores.



TCL Home App
Your TCL Smart Hub.
Download Now!

3 Connect your Soundbar system

After you have fixed the position of the Soundbar, you can start connecting it to your TV or other devices and listen to the audio through your Soundbar. Make sure you have muted the audio of your TV or device. For information, check the user manual of your TV or device.

Connect with the HDMI cable

Note

- Make sure your TV or device supports the HDMI (eARC/ARC) feature. For information, check the user manual of your TV or device.

Connect one end of the HDMI cable to the HDMI eARC input connector on your Soundbar and another end to the HDMI (eARC/ARC) output connector of your TV or device.

To get the best possible audio experience using the HDMI cable, follow below given steps:

For TCL TV:

- ① Connect HDMI cable from the HDMI (eARC) interface on the Soundbar to the HDMI (eARC/ARC) interface on the TV.
- ② Enable the CEC function in the settings of the TCL TV. (See TV User Manual for instructions)

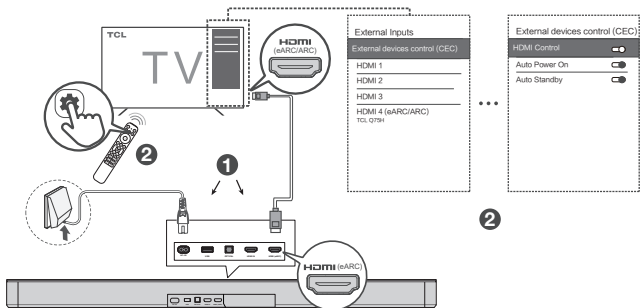

For other TV brands:

- 1 Connect HDMI cable from the HDMI (eARC) interface on the Soundbar to the HDMI (eARC/ARC) interface on the TV.
- 2 Enable the CEC function in the settings of the TV.

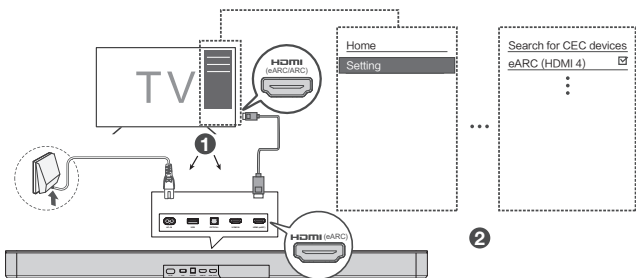

★ CEC (Consumer Electronic Control) function naming may differ by TV manufacturer. This feature may be called CEC, Anynet+, SimpLink, BRAVIA Link, EasyLink or VIERA Link. Please see your TV's user manual for more information.

TCL Tutti Choral

When the Soundbar is connected, “TV+Soundbar” menu appears on the TV.

Settings → Display & Sound → Audio Output → Internal Speaker+Soundbar(HDMI)

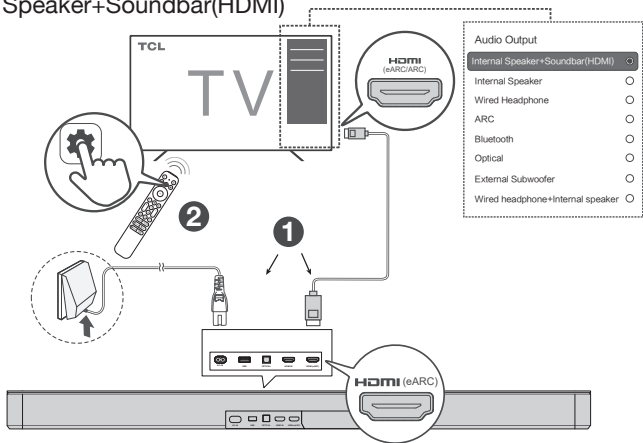

Note

- The message displayed may differ with the TV model.
- This function is compatible with some TCL TVs (please visit the TCL official website for specific models). The operation methods for different televisions may vary.
- Please find the latest version TCL Tutti Choral compatibility list of the TV models on TCL support web.



This function is available in some TCL TVs and some TCL models.

Connect with the optical cable

- 1 Remove the protective caps from the optical cable when necessary.
- 2 Connect one end of the optical cable to the optical input connector on your Soundbar and another end to the optical output connector of your TV or device.

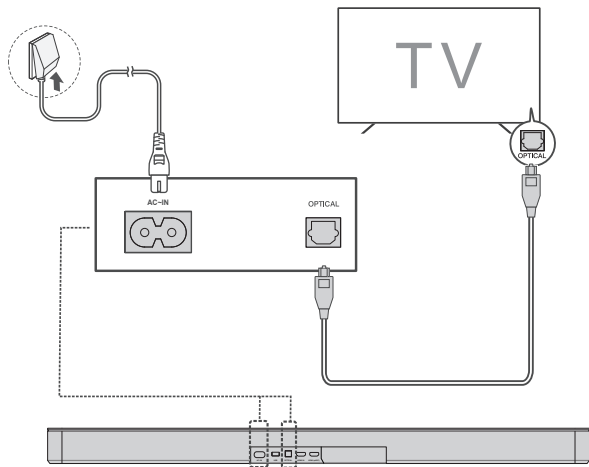

Note

- If there is no sound output from the Soundbar, try to activate the PCM signal output on your TV or device. PCM is used to convert analog audio signals into digital audio signals in most devices. For more information of how to activate the PCM signal output, check the user manual of your TV or device.

Direction for setting up your Soundbar using an optical cable



Do not bend or kink the optical cable (SPDIF) as it is fragile and can easily get damaged and broken.

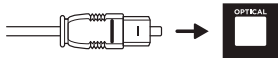

To get the best possible audio experience using the optical cable:

- 1 Press the Home button on your TCL TV Remote.
- 2 Navigate to **Audio option** under **Settings**.
- 3 Change the TV settings so that the sound of the TV can be output from the speaker system. Depending on your TV, this may be set automatically when the speaker system is connected. Refer to the operating instructions of your TV.

Notes

- *Different devices may have different menu options.*
- *Devices such as Blu-ray players, set-top boxes, etc. are also applicable.*

Connect your Soundbar to power supply

- 1 Make sure that you have completed all other connections before connecting the Soundbar to power supply.
- 2 Make sure the power supply voltage complies with your country's safety standards (see 'Specifications' on page 36)
- 3 Connect one end of a supplied AC power cord to the AC input connector on your Soundbar and another end to the power socket on the wall.

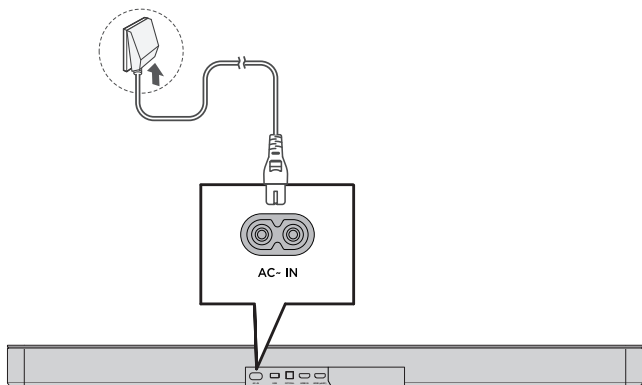



Connect the Soundbar with your Bluetooth device

Notes

- Make sure your wireless device supports the Bluetooth function.
- The operational range between the Soundbar and your Bluetooth device is approximately 10 meters (without any obstacle between the Bluetooth device and the Soundbar).

1 Press .

2 Press .

3 Press and hold  on the Remote Control or press and hold  on your Soundbar.

➔ You will see LED display shows "PAIRING". The Soundbar is ready to pair.

4 Power on our Bluetooth device and ensure it is in Pairing mode.

5 Select **TCL Q75H**.

➔ You will see LED display shows "CONNECTED". Pairing is successful.

6 Repeat Step 3 to pair other devices.

Tip

- If you cannot find the model name **TCL Q75H** on your Bluetooth device, press and hold  on the Remote Control. The LED display will show "PAIRING". Now the Soundbar is coming into the pairing mode.

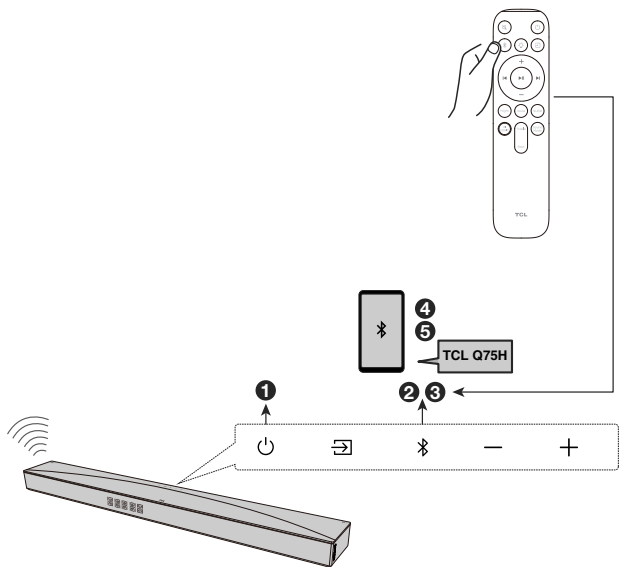

Streaming Audio with Apple AirPlay

This Soundbar supports Apple's "WAC (Wireless Accessory Configuration)" setup mode.

WAC setup mode allows you to connect it to the same network of your iOS device automatically.

- 1 Power on the Soundbar.
- 2 Press and hold the combination keys: "Power" & "Vol-" & "Vol+" at the same time on the top panel of the Soundbar.
- 3 Go to the Wi-Fi menu under Settings on your iOS device.
- 4 Select "TCL Q75H" under "SET UP NEW AIRPLAY SPEAKER...".
- 5 Follow the instructions on the screen to complete the setup process.

When connected, LED Display on the Soundbar will show "WIFI CONNECTED".

Now you can enjoy AirPlay from any iOS device on the same network.

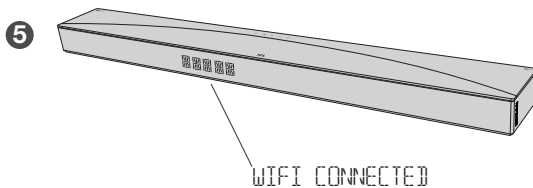
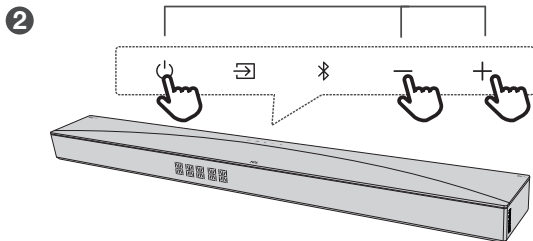
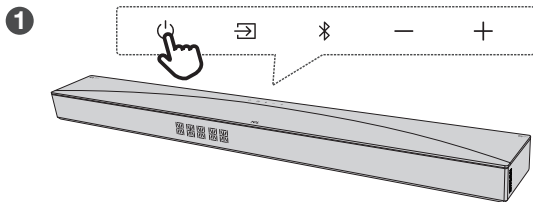

4 Use your Soundbar system

Use your Soundbar with the top panel or Remote Control

- 1 Make sure the Soundbar is properly connected to the power supply and sources.
- 2 Press  at the top panel of your Soundbar or Remote Control to switch to the correct source.

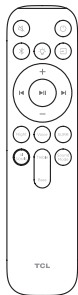

The Soundbar LED display indicates various Soundbar functions.

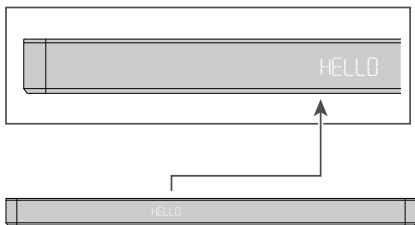

HELLO

	Soundbar Status	LED Display Status
Power	Power on Power off	HELLO STDBY / SLEEP
Source	HDMI eARC/ARC Optical USB Bluetooth HDMI IN	HDMI EARC OPT USB BT HDMI IN
Bluetooth	Searching mode (flashing) Pairing mode	BT PAIRING
Volume control	Volume level Minimum volume reached Maximum volume reached Mute	V 36 MIN MAX MUTE
Audio setting	Bass (+/-) Treble (+/-) Voice Enhance Surround Enhance AI SONIC Pass Through Night	BAS LOW / BAS MEDIUM / BAS HIGH TRE LOW / TRE MEDIUM / TRE HIGH VOICE ON / VOICE OFF SURR ON / SURR OFF POSITION 1 / POSITION 2 / POSITION 3 / OFF PASS THROUGH / -X- & PASS THROUGH NIGHT ON / NIGHT OFF
Sound modes	Standard/Movie/Music/ Voice/Game/Sports	STANDARD MOVIE MUSIC VOICE GAME SPORTS
Light	Light Setting	LIGHT 1 / LIGHT 2 / LIGHT 3

Note: After powering on your Soundbar, if there is no operation performed on either the Soundbar or Remote Control within 10 seconds, all LED indicators on the Soundbar will turn off and light up again when the operation is resumed.

Tip: You can use more advanced functions on the Remote Control (see ‘Overview of the Remote Control’ on page 16).

Listen to music from your Bluetooth device

- 1 Make sure that your device supports A2DP and/or AVRCP. For information, check the specification of your device.
- 2 Pair your Bluetooth device with the Soundbar (see ‘Connect the Soundbar with your Bluetooth device’ on page 25).
- 3 Start listening to music stored in your Bluetooth device through the Soundbar.
 - If your Bluetooth device supports A2DP, you can listen to music, but you cannot control the playback.
 - If your Bluetooth device supports AVRCP, you can listen to music and control music playback with the Remote Control. Press the center button to pause or resume music playback. Press left/right button to skip to the previous/next track.

Note

- The operational range between the Soundbar and your Bluetooth device is approximately 10 meters (without any obstacle between the Bluetooth device and Soundbar).

Use the USB cable or device for music playback

- Press play/pause button on the Remote Control to listen to/pause/resume the music.
- Press left/right button on the Remote Control to skip to the previous or next track.
- Press up/down button to increase or decrease the volume level.

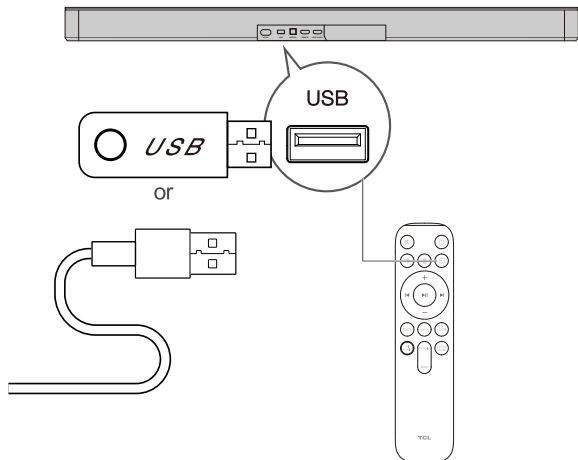

Tip

- This Soundbar can support USB devices of up to 128GB memory and the supported file format is MP3, WMA, WAV, FLAC.
- Music in folders of the USB device should be within 5 (including 5) directory levels. Otherwise, the Soundbar can not detect the music.

5 Software update

TCL may offer updates for the Soundbar's system firmware in the future.

When an update is available, you can upgrade the Soundbar by connecting the USB drive or using TCL HOME app to update the firmware online.

Online update

Follow the instructions in the image below to update the firmware on TCL HOME app.

Note

- The message displayed may differ.
- Do not exit the TCL HOME app during the update process.

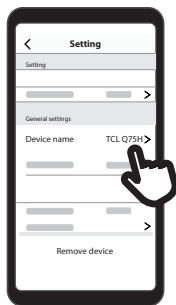

1



2

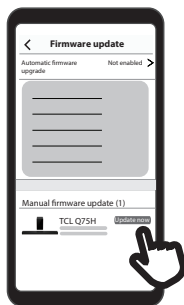

3

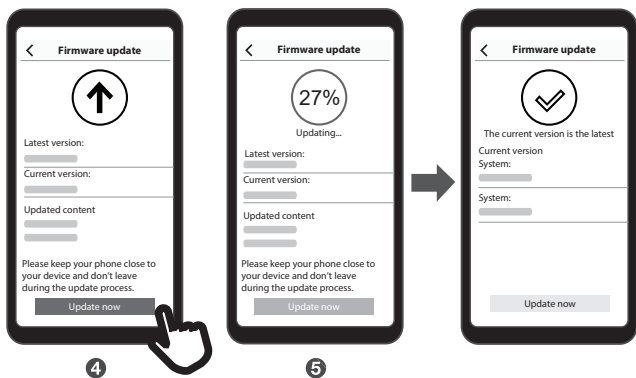

USB update

Requirements:

- TCL Soundbar
- Computer connected to the Internet
- A USB storage device formatted in FAT/FAT32 with at least 100MB of free space.

Note: Please remove all the files and folders from the USB storage device (after that it should be empty).

Update Procedure:

- Find and download the latest update file for your TCL Soundbar on TCL support web (www.TCL.com -> Support). It is VERY important to use the correct file for your specific model.
- Move or copy the downloaded file to your FORMATTED and EMPTY USB storage device. Once completed, the file named “.UPG” should be the ONLY file located on

the USB storage device.

C. Upgrade the TCL Soundbar using the following steps:

Step 1: Unplug and reconnect the power cord, then restart the Soundbar.

Step 2: Switch the Soundbar to USB mode and plug in the USB storage device.

Step 3: The system will automatically upgrade and you can understand the updates process by the Soundbar LED.

Step 4: The soundbar will restart after the updates completed, the whole process of the update will take approximately 3mins. Please REMOVE the USB storage device from the Soundbar after the upgrade completed.

IMPORTANT:

1. During the update process, DO NOT remove the USB storage device, unplug the power cord, or turn off the Soundbar.
2. The LED display shows "UPG FAIL" if the upgrade is not successful, please unplug the power cord and the USB device then repeat the above steps to upgrade the Soundbar again.

6 Specifications

Product Name

5.1.2 Channel Dolby Atmos Soundbar with Wireless Subwoofer

Soundbar

- Power Supply: AC 100-240V~50/60Hz
- USB: 5V==500mA max
- Power consumption: 58W
- Power consumption at standby mode (after long pressing the power button for 3 seconds): < 0.5W
- Power consumption at standby mode (when the Soundbar has no signal input or audio output for 19 mins) with TCL Home APP on: < 2W
- Impedance: 8 Ω
- Frequency response: 180Hz-20KHz
- Dimensions (WxHxD): 1054x68x123.5mm
- Weight: 5.62 kg
- Operating temperature: 0°C - 45°C
- Bluetooth frequency range: 2400 – 2483.5 MHz
- Bluetooth transmitter power: <13 dBm (EIRP)
- Wi-Fi network: IEEE 802.11 a/b/g/n/ac (2.4GHz/5GHz)
- 2.4G Wi-Fi frequency range: 2412 – 2472 MHz
- 2.4G Wi-Fi transmitter power: < 20 dBm (EIRP)
- 5G Wi-Fi frequency range: 5.15 – 5.35 GHz, 5.470 – 5.725 GHz, 5.725 – 5.825 GHz
- 5G Wi-Fi transmitter power: < 23 dBm (EIRP)
- 2.4G Wireless frequency range: 2406 – 2474MHz
- 2.4G Wireless transmitter power: <10 dBm (EIRP)

Wireless Subwoofer

- Power Supply: AC 100-240V~50/60Hz
- Power consumption: 40W
- Power consumption at standby mode: < 0.5W
- Power consumption at standby mode (when the Subwoofer has no signal input or audio output for 2 mins) with T-Home APP on: < 2W
- Impedance: 4 Ω
- Frequency response: 40Hz-180Hz

- Frequency range: 2406MHz-2474MHz
- Max transmitting power: 10dBm
- Dimensions (WxHxD): 220x368.66x275mm
- Weight: 6.38 kg

Bluetooth

- Bluetooth version: 5.1, Bluetooth profile - Bluetooth stereo supported (Advanced Audio Distribution Profile - A2DP; Audio Video Remote Control Profile - AVRCP)
- Frequency range: 2400MHz-2483.5MHz
- Max transmitting power: 13dBm

Remote Control

- Distance/Angle: 6m/ 30°
- Battery type: 1.5V AAA battery x 2, user replaceable.

For 5G WIFI Device

The device for operation in the band 5150-5350 MHz is only for indoor use to reduce the potential for harmful interference to co-channel mobile satellite systems.

* Operation of 5150–5350MHz is restricted to indoor use only.

	BE	BG	CZ	DK	DE	EE	IE
	EL	ES	FR	HR	IT	CY	LV
	LT	LU	HU	MT	NL	AT	PL
	PT	RO	SI	SK	FI	SE	UK (NI)

7 Notice

Declaration of conformity



Hereby, TCL Overseas Marketing Limited declares that the radio equipment type Soundbar is in compliance with relevant UK statutory requirements.

The full text of the declaration of conformity is available at the following internet address: <http://www.tcl.com> go to Support and enter the model name.

Hereby, TCL Overseas Marketing Limited declares that the radio equipment type Soundbar is in compliance with Directive 2014/53/EU.



The full text of the EU declaration of conformity is available at the following internet address: <http://www.tcl.com> go to Support and enter the model name.

Disposal of your old product and battery



Your product is designed and manufactured with high quality materials and components, which can be recycled and reused.



This symbol on a product means that the product is covered by European Directive 2012/19/EU.



This symbol means that the product contains a battery covered by European Directive 2013/56/EU

which cannot be disposed of with normal household waste. Inform yourself about the local separate collection system for electrical and electronic products and batteries. Follow local rules and never dispose of the product and batteries with normal household waste. Correct disposal of old products and batteries helps prevent negative consequences for the environment and human health.

Remove the disposable battery

To remove the disposable batteries, see the section ‘Install/replace the remote control battery’.

Environmental protection and sustainability

We have omitted all unnecessary packaging and make sure it is eco-friendly and sustainable.

Statement of Compliance

2023 No. 1007 The Product Security and Telecommunications infrastructure (Security Requirements for Relevant Connectable Products) Regulations 2023

The product is in compliance with the following standard(s) or normative document(s):

ETSI EN 303 645 V2.1.1:2020-06

Provision 5.1-1

Provision 5.1-2

Provision 5.2-1

Provision 5.3-13

The full text of the UK declaration of conformity is available at the following internet address: www.tcl.com.

Choose the model name and go to **DOWNLOADS**.

Trademarks



Dolby, Dolby Atmos, and the double-D symbol are registered trademarks of Dolby Laboratories Licensing Corporation. Manufactured under license from Dolby Laboratories. Confidential unpublished works. Copyright © 2012-2024 Dolby Laboratories. All rights reserved.



The Bluetooth® word mark and logos are registered trademarks owned by Bluetooth SIG, Inc. and any use of such marks by TTE Corporation is under license. Other trademarks and trade names are those of their respective owners.



For DTS patents, see <http://patents.dts.com>. Manufactured under license from DTS Licensing Limited. DTS, DTS:X, and the DTS:X logo are registered trademarks or trademarks of DTS, Inc. in the United States and other countries. © 2024 DTS, Inc. ALL RIGHTS RESERVED.



“The terms HDMI, HDMI High-Definition Multimedia Interface, HDMI trade dress and the HDMI Logos are trademarks or registered trademarks of HDMI Licensing Administrator, Inc.”



Works with

Apple AirPlay

Apple, AirPlay, Apple Home, and Apple TV are trademarks of Apple Inc., registered in the U.S. and other countries and regions.



CERTIFIED

The Wi-Fi CERTIFIED™ Logo is a certification mark of Wi-Fi Alliance®.

8 FAQ

No power

- Make sure the AC power cord and AC input connector are connected properly.
- Make sure there is power supply.
- Make sure the Soundbar has turned on.

No sound

- Make sure the audio cable is connected to the Soundbar and your device.
- Make sure you have selected the correct source.
- Press up button to increase the volume level.
- Make sure the Soundbar is not muted.

Low voice

- Use the Remote Control to adjust the volume.

The Remote Control does not work.

- Make sure you have selected the correct source.
- Make sure the distance of Remote Control and the Soundbar is within operational range.
- Make sure the battery is correctly inserted and is working.
- Make sure the Remote Control is close to the Remote Control sensor of the Soundbar.

I hear distorted sound.



- Make sure all cables are properly connected.
- Make sure you have selected the correct source.
- Make sure the TV is muted if you play audio from the TV.

I cannot find the Bluetooth name of this Soundbar on my Bluetooth device.

- Make sure the Bluetooth function is activated and the LED display will show "PAIRING". If the LED display shows nothing, long press Bluetooth button on the Remote Control and make sure the LED display shows "PAIRING".
- Make sure the Soundbar has paired with your Bluetooth device.

How to pair Subwoofer with Soundbar?

THE SUBWOOFER WILL PAIR AUTOMATICALLY WITH SOUNDBAR UPON THE FIRST USE. In case of a problem, take the following steps to manually pair:

- Press and hold the  button on the Subwoofer for 3 seconds until an amber light begins flashing on the  button.
- Press and hold the  button on the Soundbar for 10 seconds until the LED display shows "SETUP PAIR" on the Soundbar.
- After a short while, the Subwoofer LED will turn solid. The Subwoofer is now connected to the Soundbar.

TCL support:

Please visit www.tcl.com

**WE ARE
READY TO**

HELP **contact us first
with any questions**



**TAKE CARE WHEN
REMOVING THE SOUNDBAR**

Copyright © 2024 TCL. All rights reserved.
English-Q75H-EU_EN_UM_V1.2

